

PanelView Plus Compact Terminals



User Manual

Catalog Numbers 2711PC-K4M20D,
2711PC-B4C20D, 2711PC-T6M20D,
2711PC-T6C20D, 2711PC-T10C4D1

Important User Information

Solid state equipment has operational characteristics differing from those of electromechanical equipment. Safety Guidelines for the Application, Installation and Maintenance of Solid State Controls (publication [SGI-1.1](#) available from your local Rockwell Automation sales office or online at <http://literature.rockwellautomation.com>) describes some important differences between solid state equipment and hard-wired electromechanical devices. Because of this difference, and also because of the wide variety of uses for solid state equipment, all persons responsible for applying this equipment must satisfy themselves that each intended application of this equipment is acceptable.





In no event will Rockwell Automation, Inc. be responsible or liable for indirect or consequential damages resulting from the use or application of this equipment.

The examples and diagrams in this manual are included solely for illustrative purposes. Because of the many variables and requirements associated with any particular installation, Rockwell Automation, Inc. cannot assume responsibility or liability for actual use based on the examples and diagrams.

No patent liability is assumed by Rockwell Automation, Inc. with respect to use of information, circuits, equipment, or software described in this manual.

Reproduction of the contents of this manual, in whole or in part, without written permission of Rockwell Automation, Inc., is prohibited.

Throughout this manual, when necessary, we use notes to make you aware of safety considerations.

WARNING 	Identifies information about practices or circumstances that can cause an explosion in a hazardous environment, which may lead to personal injury or death, property damage, or economic loss.
IMPORTANT	Identifies information that is critical for successful application and understanding of the product.
ATTENTION 	Identifies information about practices or circumstances that can lead to personal injury or death, property damage, or economic loss. Attentions help you identify a hazard, avoid a hazard, and recognize the consequence
SHOCK HAZARD 	Labels may be on or inside the equipment, for example, a drive or motor, to alert people that dangerous voltage may be present.
BURN HAZARD 	Labels may be on or inside the equipment, for example, a drive or motor, to alert people that surfaces may reach dangerous temperatures.

Allen-Bradley, PanelView Plus, PanelView Plus Compact, FactoryTalk View, FactoryTalk View ME, FactoryTalk View Studio, FactoryTalk ViewPoint, RSLinx Enterprise, Rockwell Automation, and TechConnect are trademarks of Rockwell Automation, Inc.

Trademarks not belonging to Rockwell Automation are property of their respective companies.

Preface	Intended Audience	7
	Parts List.	7
	Additional Resources.	7
	Chapter 1	
Overview	Chapter Objectives	9
	Product Overview.	9
	Catalog Number Explanation	9
	Software Support	10
	Hardware Configurations.	10
	Displays	11
	Accessories.	11
	Chapter 2	
Installing the Terminal	Chapter Objectives	13
	Hazardous Locations	13
	Environment and Enclosure.	16
	Required Tools	17
	Clearances	17
	Cutout Dimensions	17
	Mount the 400 or 600 Terminal in a Panel	18
	Mount the 1000 Terminal in a Panel.	20
	Product Dimensions	22
	Chapter 3	
Connecting Power	Chapter Objectives	23
	Wiring and Safety Guidelines.	23
	Removing and Installing the Power Terminal Block	24
	Connecting Power.	26
	Resetting the Terminals	29
	Chapter 4	
Configuring the Terminal	Chapter Objectives	31
	Accessing Configuration Mode.	31
	Loading an Application	35
	Running an Application.	36
	Application Settings.	36
	Terminal Settings	36
	Configuring Communication	37
	Configuring Network Information	41
	Configuring Diagnostics	45
	Managing Files on the Terminal.	47
	Modifying Display Settings	50
	Font Linking	53
	Configuring the Keypad, Keyboard, or Mouse	54

	Configuring the Touch Screen	56
	Configuring Print Options	58
	Configuring Startup Options	60
	Configuring Startup Tests.	63
	Clearing the System Event Log.	65
	Displaying Terminal Information	66
	Displaying	
	FactoryTalk View ME Station Information.	68
	Modifying the Date, Time, or Time Zone	69
	Modifying Regional Settings.	71
	Chapter 5	
Installing and Replacing Components	Chapter Objectives	75
	Required Tools	75
	Precautions.	75
	Replacing the Battery	76
	Replacing the Backlight.	79
	Using an External CompactFlash Card	81
	Removing the Product ID Label	82
	Replacing the Bezel.	83
	Cleaning the	
	Display Window	85
	Chapter 6	
Terminal Connections	Chapter Objectives	87
	Cables for Runtime Communication.	87
	Communication Port Isolation	88
	USB Ports	89
	Serial Connections.	90
	Ethernet Connections	93
		Chapter 7
Upgrading Firmware	Chapter Objectives	95
	Transferring Applications.	95
	Firmware Upgrade Wizard.	95
	Preparing Terminal	
	for Upgrade	95
	Upgrading Firmware with a CompactFlash Card	96
Upgrading Firmware over a Network Connection.	100	

Troubleshooting	Chapter 8	
	Chapter Objectives	105
	Status Indicators	105
	Isolating the Problem	106
	Startup Information Messages	108
	Startup Sequence	109
	Startup Error Messages	110
	Checking Terminal Components	111
	Ethernet Connection	114
	Hardware Compatibility.	115
	Application Does Not Load	115
	Application Does Not Run.	116
	Configuration Mode Access	116
Specifications	Appendix A	
	Electrical.	117
	Environmental	117
	Display.	118
	Mechanical	118
	General	119
	Agency Certifications.	119
USB Devices	Appendix B	
	Compatible USB Devices.	121
Available Fonts	Appendix C	
	Download Fonts to Terminal	123
	Machine Edition Fonts CD.	124
Index	127

Intended Audience

Use this manual if you are responsible for installing, configuring, and operating the PanelView Plus Compact terminals.

No special knowledge is required to understand this manual or operate the terminal. However, you must understand the functions and operations of the FactoryTalk View ME applications that will run on the terminal. Consult the application designer for this information.

Equipment installers must be familiar with standard panel installation techniques.

Parts List

Your terminal is shipped with these items:

- Power terminal block
- FactoryTalk View ME runtime software preloaded
- Mounting levers or mounting clips (model dependent)
- Panel cutout template
- Installation instructions

Additional Resources

The table lists resources available for the PanelView Plus terminals.

Resource	Description
PanelView Plus 400 and 600 Terminals Installation Instructions, publication 2711P-IN002	Provides details on how to install the terminals in a panel, and wire power.
PanelView Plus 700 to 1500 Terminals and Display Modules, and PanelView Plus Compact 1000 Terminals, Installation Instructions, publication 2711P-IN001	Provides details on how to install the terminals in a panel, and wire power.
Wiring and Grounding Guidelines for PanelView Plus Devices Technical Data, publication 2711P-TD001	Provides grounding and wiring guidelines for PanelView Plus terminals.

You can view or download publications at <http://literature.rockwellautomation.com>. To order paper copies of technical documentation, contact your local Rockwell Automation distributor or sales representative.

Overview

Chapter Objectives

This chapter covers these topics:

- Product description
- Catalog number explanation
- Software support
- Terminal configurations
- Display modules
- Accessories

Product Overview

The PanelView Plus Compact terminals are similar to some PanelView Plus terminal configurations but with limited hardware and software functions. Major differences of the compact terminals include:

- Fixed hardware configuration, without the addition or replacement of modular components.
- Serial and Ethernet communication only.
- Connection to a single logic controller using either RSLinx Enterprise or KEPServer Enterprise software, not both.
- Limited number of displays and alarms in the FactoryTalk View Machine Edition (ME) application and runtime software.
- FactoryTalk ViewPoint software is not supported.
- Primary HMI for CompactLogix controllers.

TIP

Applications created for PanelView Plus Compact terminals are referred to as Compact Machine Edition applications. You can run compact applications on PanelView Plus and PanelView Plus Compact terminals. You cannot run a regular Machine Edition application created for a PanelView Plus terminal on a PanelView Plus Compact terminal.

Catalog Number Explanation

The table provides catalog number configurations for the PanelView Plus Compact terminals.

Cat. No.	Display Size	Operator Input	Display Type	Input Power
2711PC-K4M20D	4 inch	Keypad	Monochrome	DC
2711PC-B4C20D		Keypad and Touch	Color	
2711PC-T6M20D	6 inch	Touch	Monochrome	
2711PC-T6C20D			Color	
2711PC-T10C4D1	10 inch	Touch	Color	

Software Support

Each terminal is preloaded with FactoryTalk View Machine Edition runtime and configuration software that does not require activation. Applications for the compact terminals are created using FactoryTalk View Studio software.

Software Requirements	Version
FactoryTalk View Studio	5.1 or later
RSLinx Enterprise ⁽¹⁾	5.20 or later

⁽¹⁾ RSLinx Enterprise software is provided with FactoryTalk View Studio. During software installation, you are prompted to install RSLinx Enterprise software.

Compact Machine Edition applications are restricted to a subset of the functions allowed on the PanelView Plus terminals.

- Maximum of 25 displays
- Maximum of 200 alarm messages
- Maximum screen resolution of 640 x 480 (VGA)
- one connection or shortcut to a single controller using either RSLinx Enterprise 5.20 or KEPServer Enterprise.
- Serial and Ethernet communication only.
If using RSLinx Enterprise, only serial-DF1, serial-DH485 and Ethernet drivers are supported.

Hardware Configurations

The terminal configurations are fixed and do not support communication modules. The 1000 touch terminal has a fixed display module and logic module that cannot be replaced.

400 and 600 Configurations

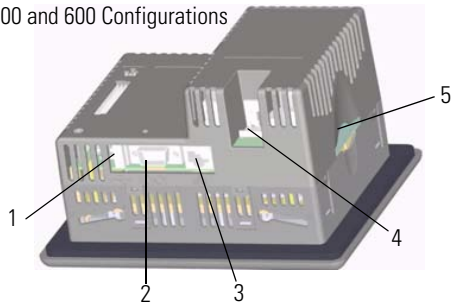

1000 Configuration

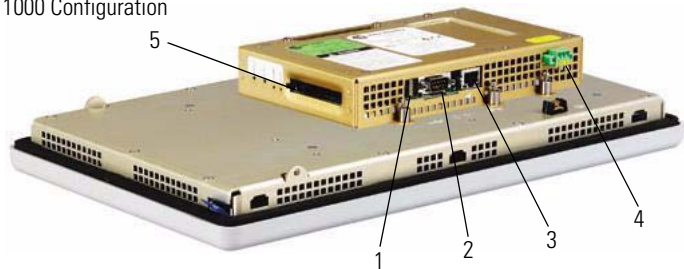

Item	Description
1	USB port ⁽¹⁾
2	RS-232 serial port
3	10/100BaseT Ethernet port
4	Power input, 24V DC
5	CompactFlash Type 1 card slot

⁽¹⁾ The 400 and 600 models have one USB port; the 1000 model have two USB ports.

Displays

The terminal configurations provide monochrome or color displays with keypad, touch, or keypad/touch input.



Keypad Description of 400 Terminals

Keys	Description
F1 through F8	Programmable keys that initiate functions on terminal display.
Numeric Keypad	0...9, ., -, Backspace, Enter, Left and Right Tab keys, Shift keys
Navigation Keys	Use the arrow keys for navigation. Use the Alt+arrow keys to activate home, end, page up, and page down functions.

ATTENTION



Use a finger or gloved finger to operate the keypad. To operate the touch screen, use your finger, gloved finger, or plastic stylus with a minimum tip radius of 1.3 mm (0.051 in.). Using other object or tool may damage the touch screen or keypad.

Accessories

The compact terminals use many of the same accessories as the PanelView Plus terminals with the exception of the display modules, communication modules, logic modules, and memory.

IMPORTANT

The PanelView Plus Compact terminals do not support the addition or replacement of modular components.

Compact Flash Cards

Cat. No.	Description
2711P-RC2	128 MB blank CompactFlash card
2711P-RC3	256 MB blank CompactFlash card
2711P-RC4	512 MB blank CompactFlash card
2711P-RCH	CompactFlash to PCMCIA adapter

Backlight

Cat. No.	Description
2711P-RL10C2	Replacement color backlight for 1000 series B and C displays

Replacement Bezels

Cat. No.	Description
2711P-RBT10	Replacement bezel for 1000 touch terminal

Protective Antiglare Overlays

Cat. No.	Description
2711P-RGK4	Antiglare overlay (3) for PanelView Plus 400 keypad terminal
2711P-RGB4	Antiglare overlay (3) for PanelView Plus 400 color keypad/touch terminal
2711P-RGT6	Antiglare overlay (3) for PanelView Plus 600 touch terminal
2711P-RGT6	Antiglare overlay (3) for PanelView Plus 600 touch terminal
2711P-RGT10	Antiglare overlay (3) for PanelView Plus 1000 touch terminal

Adapter Plates

Cat. No.	Description
2711P-RAK4	Adapts a PanelView Plus 400 keypad terminal to a PanelView Standard 550 keypad cutout
2711P-RAT10	Adapts a PanelView Plus 1000 touch terminal to a PanelView 1000/1000E touch cutout

Cables

Cat. No.	Description
2711-NC13	RS-232 operating/programming cable (9-pin D-shell to 9-pin D-shell), 5 m (16.4 ft)
2711-NC14	RS-232 operating/programming cable (9-pin D-shell to 9-pin D-shell), 10 m (32.7 ft)
2711-NC17	Remote RS-232 serial cable (9-pin D-shell to 9-pin D-shell)
2711-NC21	RS-232 operating cable (9-pin D-shell to 8-pin mini DIN), 5 m (16.4 ft)
2711-NC22	RS-232 operating cable (9-pin D-shell to 8-pin mini DIN), 10 m (32.7 ft)
2711P-CBL-EX04	Ethernet CAT5 crossover cable, industrial grade, 4.3 m (14 ft)

Communication Adapters

Cat. No.	Description
1761-NET-AIC	AIC+ advanced interface converter

Miscellaneous

Cat. No.	Description
2711P-RY2032	Replacement battery for 1000 terminal
2711P-RTMC	Replacement mounting clips for 1000 terminals, quantity of 8
2711P-RTFC	Replacement mounting levers for 400 and 600 terminals, quantity of 8
2711-TBDC	Replacement DC power terminal block for 400 and 600 terminals
2711P-RTBDC2	Replacement two-position DC power terminal block for 1000 terminal

Installing the Terminal

Chapter Objectives

This chapter provides pre-installation information and procedures on how to install the terminals.

- Hazardous locations
- Environment and enclosure
- Required tools
- Clearances
- Panel cutout dimensions
- Mount the 400 or 600 terminal in a panel
- Mount the 1000 terminal in a panel
- Product dimensions

Hazardous Locations

This equipment is suitable for these locations:

- Class I, Division 2, Groups A, B, C, D
- Class II, Division 2, Groups F, G
- Class III
- ordinary, nonhazardous locations

The following statement applies to use in hazardous locations.

WARNING



Explosion Hazard

- Substitution of components may impair suitability for hazardous locations.
- Do not disconnect equipment unless power has been switched off and area is known to be nonhazardous.
- Do not connect or disconnect components unless power has been switched off.
- All wiring must comply with N.E.C. articles 501, 502, 503, and/or C.E.C. section 18-1J2 as appropriate.
- Peripheral equipment must be suitable for the location in which it is used.

The terminals have a temperature code of T4 when operating in a 55 °C (131 °F) maximum ambient temperature. Do not install the terminals in environments where atmospheric gases have ignition temperatures **less** than 135 °C (275 °F).

USB Ports

The PanelView Plus Compact terminals contain universal serial bus (USB) ports that comply with hazardous location environments. This section details the field-wiring compliance requirements and is provided in accordance with the National Electrical Code, article 500.

PanelView Plus Compact Terminals Control Drawing

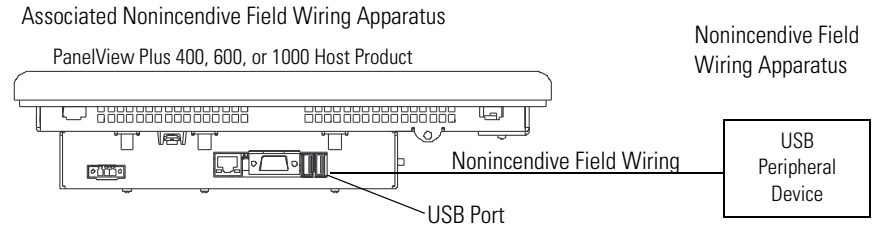

Table 1 - PanelView Plus Compact USB Port Circuit Parameters

Display Size	V_{oc}	I_{sc}	C_a		L_a	
			Groups A and B	Groups C and D	Groups A and B	Groups C and D
400 and 600 Series C or later	5.25V DC	1.68 A	10 μ F	10 μ F	3.5 μ H	15 μ H
1000	5.25V DC	1.68 A	10 μ F	10 μ F	15 μ H	15 μ H

Selected nonincendive field wiring apparatus must have nonincendive circuit parameters conforming with Table 2.

Table 2 - Required Circuit Parameters for the USB Peripheral Device

V_{max}	\geq	V_{oc}
I_{max}	\geq	I_{sc}
$C_i + C_{cable}$	\leq	C_a
$L_i + L_{cable}$	\leq	L_a

Application Information

Per the National Electrical Code the circuit parameters of nonincendive field wiring apparatus for use in hazardous locations shall be coordinated with the associated nonincendive field wiring apparatus such that their combination remains nonincendive. The PanelView Plus terminal and the USB peripheral device shall be treated in this manner.

The circuit parameters of the PanelView Plus terminal USB port are given in Table 1. The USB peripheral device and its associated cabling shall have circuit parameters with the limits given in Table 2 for them to remain nonincendive when used with the PanelView Plus terminal USB port. If cable capacitance and inductance are not known the following values from ANSI/ISA-RP 12.06.01-2003 may be used:

$$C_{\text{cable}} = 197 \text{ pF/m (60 pF/ft)}$$

$$L_{\text{cable}} = 0.7 \text{ }\mu\text{H/m (0.20 }\mu\text{H/ft)}$$

Nonincendive field wiring must be wired and separated in accordance with 501.10(B)(3) of the National Electrical Code (NEC) ANSI/NFPA 70 or other local codes as applicable.

This associated nonincendive field wiring apparatus has not been evaluated for use in combination with another associated nonincendive field wiring apparatus.

Symbol Definitions

V_{oc}	Open circuit voltage of the host USB port.
I_{sc}	Maximum output current of the host USB port.
V_{max}	Maximum applied voltage rating of the USB peripheral device. V_{max} shall be greater than or equal to V_{oc} in Table 1. ($V_{\text{max}} \geq V_{\text{oc}}$).
I_{max}	Maximum current to which the USB peripheral device can be subjected. I_{max} shall be greater than or equal to I_{sc} in Table 1. ($I_{\text{max}} \geq I_{\text{sc}}$).
C_i	Maximum internal capacitance of the USB peripheral device.
C_a	Maximum allowed capacitance of the USB peripheral device and its associated cable. The sum of C_i of the USB peripheral device and C_{cable} of the associated cable shall be less than or equal to C_a . ($C_i + C_{\text{cable}} \leq C_a$).
L_i	Maximum internal inductance of the USB peripheral device.
L_a	Maximum allowed inductance of the USB peripheral device and its associated cable. The sum of L_i of the USB peripheral device and L_{cable} of the associated cable shall be less than or equal to L_a . ($L_i + L_{\text{cable}} \leq L_a$).

Environment and Enclosure

ATTENTION



This equipment is intended for use in a Pollution Degree 2 industrial environment, in overvoltage Category II applications (as defined in IEC 60664-1), at altitudes up to 2000 m (6561 ft) without derating.

The terminals are intended for use with programmable logic controllers. Terminals that are AC powered must also be connected to the secondary of an isolating transformer.

This equipment is considered Group 1, Class A industrial equipment according to IEC CISPR 11. Without appropriate precautions, there may be difficulties ensuring electromagnetic compatibility in residential and other environments due to conducted or radiated disturbances.

This equipment is supplied as open-type equipment. It must be mounted within an enclosure that is suitably designed for those specific environmental conditions that will be present and appropriately designed to prevent personal injury resulting from accessibility to live parts. The interior of the enclosure must be accessible only by the use of a tool. The terminals meet specified NEMA Type and IEC ratings only when mounted in a panel or enclosure with the equivalent rating. Subsequent sections of this publication may contain additional information regarding specific enclosure type ratings that are required to comply with certain product safety certifications.

In addition to this publication, see:

- Industrial Automation Wiring and Grounding Guidelines, publication [1770-4.1](#), for additional installation requirements.
- NEMA Standards 250 and IEC 60529, as applicable, for explanations of the degrees of protection provided by different types of enclosure.

Required Tools

These tools are required for panel installation:

- Panel cutout tools
- Small, slotted screwdriver
- Torque wrench (lb•in) for tightening the mounting clips on the 1000 terminal

Clearances

Allow adequate clearance around the terminal, inside the enclosure, for adequate ventilation. Consider heat produced by other devices in the enclosure. The ambient temperature around the terminals must be between 0...55 °C (32...131 °F).

Clearance Area	400 and 600 Terminals	1000 Terminal
Top	51 mm (2 in.)	51 mm (2 in.)
Bottom	102 mm (4 in.)	51 mm (2 in.)
Side ⁽¹⁾	25 mm (1 in.)	25 mm (1 in.)
Back	None	25 mm (1 in.)

⁽¹⁾ Minimum side clearance for insertion of memory card and cable wiring is 102 mm (4 in.).

Cutout Dimensions

Use the full size template shipped with your terminal to mark the cutout dimensions.

Terminal Type	Height mm (in.)	Width mm (in.)
400 Keypad, or Keypad and Touch	123 (4.86)	156 (6.15)
600 Touch	123 (4.86)	156 (6.15)
1000 Touch	224 (8.8)	305 (12.00)

Mount the 400 or 600 Terminal in a Panel

Mounting levers secure the terminal to the panel. The number of levers you use (4 or 6) varies by terminal type.

ATTENTION



Disconnect all electrical power from the panel before making the panel cutout.

Make sure the area around the panel cutout is clear.

Take precautions so metal cuttings do not enter any components already installed in the panel.

Failure to follow these warnings may result in personal injury or damage to panel components.

Follow these steps to mount the 400 or 600 terminals in a panel.

1. Cut an opening in the panel by using the panel cutout shipped with the terminal.
2. Make sure the terminal sealing gasket is properly positioned on the terminal.

This gasket forms a compression-type seal. Do not use sealing compounds.

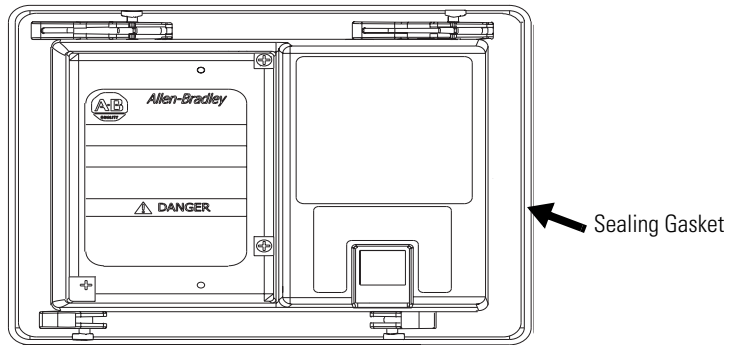

3. Place the terminal in the panel cutout.

If installing the terminal in an existing 550 panel cutout, align the terminal with the center of the cutout for best gasket sealing.

4. Insert all mounting levers into the mounting slots on the terminal.

Slide each lever until the flat side of the lever touches the surface of the panel.

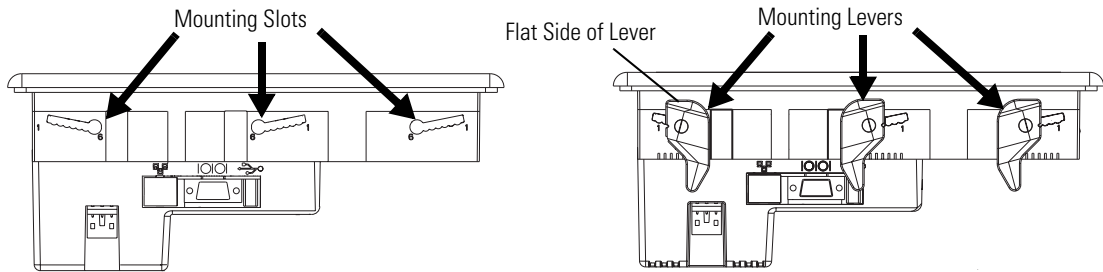

5. When all levers are in place, slide each lever an additional notch or two until you hear a click.
6. Rotate each lever in the direction indicated until it is in the final latch position.

Follow the latching sequence for the optimum terminal fit.

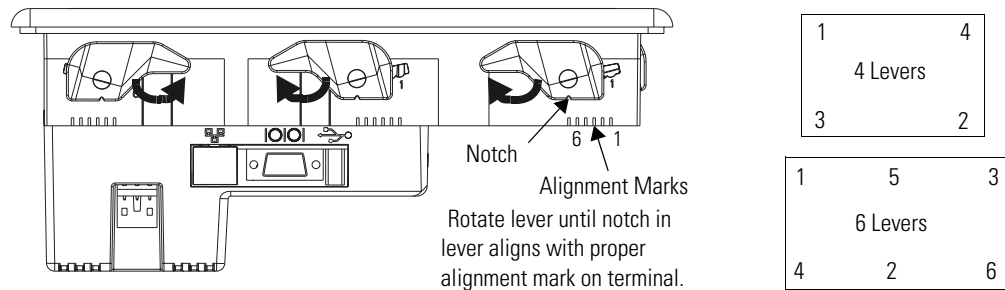

Use this table as a guide to provide an adequate gasket seal between the terminal and the panel.

	Lever Position	Panel Thickness Range	Typical Gauge
<p>Terminal Markings or Alignment</p>	1	1.52...2.01 mm (0.060...0.079 in.)	16
	2	2.03...2.64 mm (0.08...0.104 in.)	14
	3	2.67...3.15 mm (0.105...0.124 in.)	12
	4	3.17...3.66 mm (0.125...0.144 in.)	10
	5	3.68...4.16 mm (0.145...0.164 in.)	8/9
	6	4.19...4.75 mm (0.165...0.187 in.)	7

ATTENTION



Follow instructions to provide a proper seal and to prevent potential damage to the product. Rockwell Automation assumes no responsibility for water or chemical damage to the terminal or other equipment within the enclosure because of improper installation.

Mount the 1000 Terminal in a Panel

Mounting clips secure the terminal to the panel.

ATTENTION



Disconnect all electrical power from the panel before making the panel cutout.

Make sure the area around the panel cutout is clear.

Take precautions so metal cuttings do not enter any components already installed in the panel.

Failure to follow these warnings may result in personal injury or damage to panel components.

Follow these steps to mount the terminal in a panel.

1. Cut an opening in the panel by using the panel cutout shipped with the terminal.
2. Make sure the terminal sealing gasket is properly positioned on the terminal.

This gasket forms a compression-type seal. Do not use sealing compounds.



3. Place the terminal in the panel cutout.

- Slide the ends of the mounting clips into the slots on terminal.

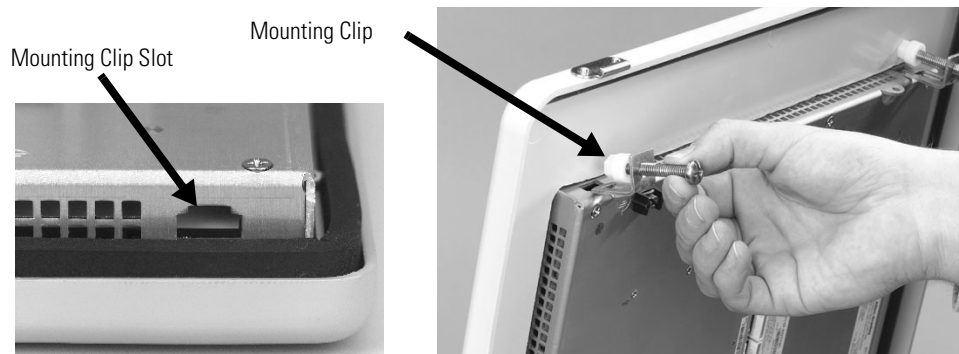

- Tighten the mounting clip screws by hand until the gasket seal contacts the mounting surface uniformly.



- Tighten the mounting clips screws to a torque of 0.90...1.1 N•m (8...10 lb•in) by using the specified sequence, making sure not to overtighten.

1	4
Torque Sequence	
3	2

ATTENTION



Tighten the mounting clips to the specified torque to provide a proper seal and to prevent damage to the product. Allen-Bradley assumes no responsibility for water or chemical damage to the product or other equipment within the enclosure because of improper installation.

Product Dimensions

Product dimensions for each terminal are in mm (in.).

PanelView Plus 400 Keypad or Keypad/Touch Dimensions

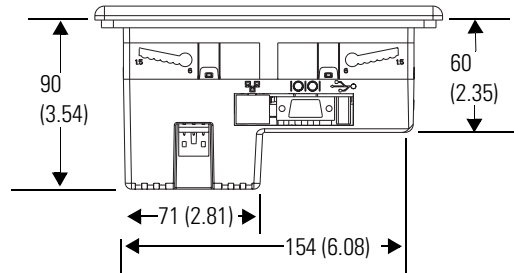
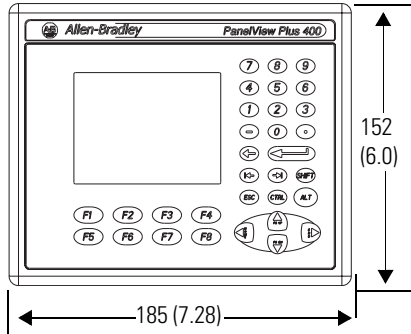

PanelView Plus Compact 600 Touch Dimensions

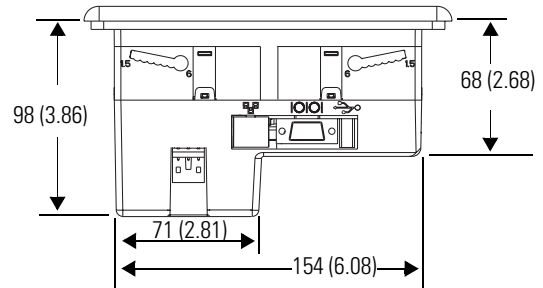
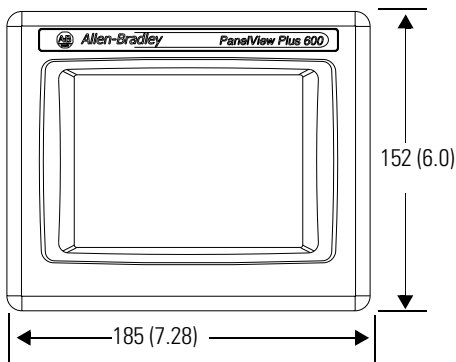

PanelView Plus Compact 1000 Touch Dimensions

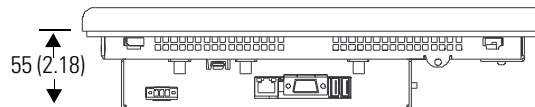
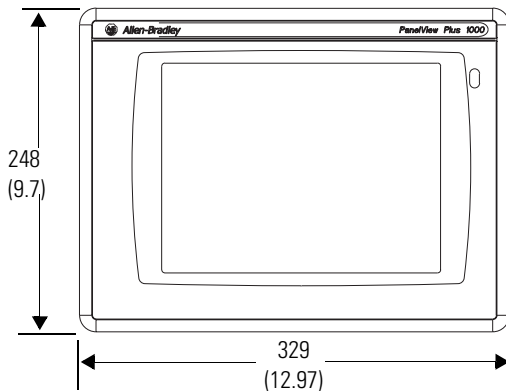

Connecting Power

Chapter Objectives

This chapter covers wiring and safety guidelines, and provides procedures to:

- remove and install the power terminal block.
- connect DC power.
- reset the terminal.

Wiring and Safety Guidelines

Use publication NFPA 70E Electrical Safety Requirements for Employee Workplaces, IEC 60364 Electrical Installations in Buildings, or other applicable wiring safety requirements for the country of installation when wiring the devices. In addition to the NFPA guidelines:

- connect the device and other similar electronic equipment to its own branch circuit.
- protect the input power by a fuse or circuit breaker rated at no more than 15 A.
- route incoming power to the device by a separate path from the communication lines.
- cross power and communication lines at right angles if they must cross.
- Communication lines can be installed in the same conduit as low-level DC I/O lines (less than 10V).
- shield and ground cables appropriately to avoid electromagnetic interference (EMI).
- Grounding minimizes noise from EMI and is a safety measure in electrical installations.

For more information on grounding recommendations, refer to the National Electrical Code published by the National Fire Protection Association.

For more information, refer to Wiring and Grounding Guidelines for PanelView Plus Devices, publication [2711P-TD001](#). You can locate this publication in the literature library at this website <http://literature.rockwellautomation.com>.

Removing and Installing the Power Terminal Block

The terminals are shipped with the power terminal block installed. You can remove the terminal block for ease of installation, wiring, and maintenance.

WARNING



Explosion Hazard

Substitution of components may impair suitability for hazardous locations.

Do not disconnect equipment unless power has been switched off and area is known to be nonhazardous.

Do not connect or disconnect components unless power has been switched off.

All wiring must comply with N.E.C. articles 501, 502, 503, and/or C.E.C. section 18-1J2 as appropriate.

Peripheral equipment must be suitable for the location in which it is used.

PanelView Plus Compact 400 and 600 Terminals

ATTENTION



Do not force terminal blocks into connectors to prevent potential damage to terminal.

Follows these steps to remove the terminal block in the PanelView 400 and 600 terminals.

1. Insert the tip of small, flat-blade, screwdriver into the terminal block access slot.
2. Gently pry the terminal block away from terminal to release the locking mechanism.

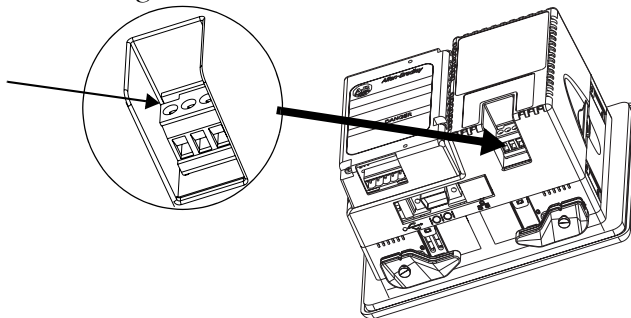

Follow these steps to replace the terminal block.

1. Press the terminal block base in first with block leaning outward.

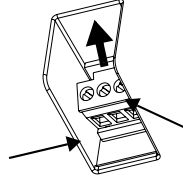

2. Gently push the top of the terminal block back to the vertical position to snap in locking tab.

PanelView Plus Compact 1000 Terminals

Follow these steps to remove the terminal block.

1. Loosen the two screws that secure the terminal block.
2. Gently pull the terminal block away from the connector.

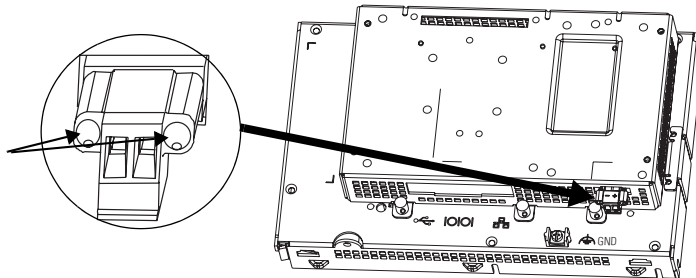

Follow these steps to install the terminal block.

1. Reattach the terminal block to the connector until seated.
2. Tighten the two screws that secure the terminal block to the connector.

Connecting Power

The PanelView Plus Compact terminals have an integrated, 24V DC power supply. See [Appendix A, Specifications](#) for power ratings.

The power supply is internally protected against reverse polarity of the DC+ and DC- connections. Connecting DC+ or DC- to the earth terminal may damage the device.

The input power terminal block supports these wire sizes.

Wire Specifications for DC Input Power Terminal Block

Terminal	Wire Type		Dual-wire Gauge ⁽¹⁾	Single-wire Gauge	Terminal Screw Torque
400 and 600	Stranded or solid	Cu 90 °C (194 °F)	22...16 AWG	22...14 AWG	0.45...0.56 N•m (4...5 lb•in)
1000					0.56 N•m (5 lb•in)

⁽¹⁾ Two-wire max. per terminal.

External Power Supply For Non-insolated DC Terminals

TIP

The PanelView Plus Compact terminals contain non-isolated DC power supplies.

Use a single, 24V DC power supply to power each PanelView Plus Compact terminal, such as cat. no. 2711P-RSACDIN. Using a separate, isolated and ungrounded source to power each terminal prevents ground loop currents from damaging the terminals.

Multiple AC Power Supplies to Power Multiple DC Terminals

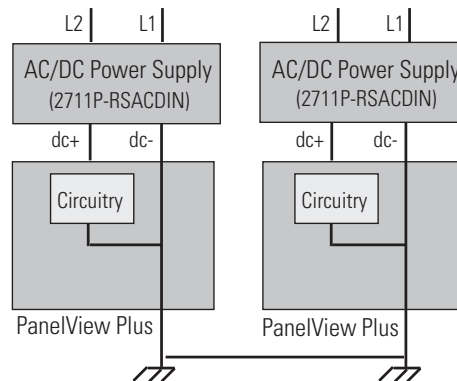

The output on the power supply must be isolated from the input and not connected to earth/ground.

The non-isolated power supply does not provide galvanic isolation. A Class 2 or Safety Extra-Low Voltage (SELV) isolated power supply with a 24V DC nominal output voltage is required to power the terminal.

ATTENTION



Use a Class 2 or SELV supply as required by local wiring codes for your installation. The Class 2 and SELV power sources provide protection so that under normal and single-fault conditions, the voltage between the conductors, and between the conductors and functional earth or protective earth does not exceed a safe value.

Earth/Ground Connection

You must connect the earth/ground terminal to a low-impedance earth/ground.



- The 1000 terminals have the earth/ground connection on the rear of the display module.
- The 400 and 600 terminals have the functional earth/ground connection on the power input terminal block.

IMPORTANT

The earth/ground connection to ground is mandatory. This connection is required for noise immunity, reliability, and Electromagnetic Compliance (EMC) with the European Union (EU) EMC directive for CE-mark conformance and is required for safety by Underwriters Laboratory.

The earth terminal requires a minimum wire gauge.

Earth Wire Specifications

Terminal	Symbol	Wire Type		Wire Gauge	Terminal Screw Torque
400 and 600		Stranded or solid	Cu 90 °C (194 °F)	14...12 AWG	0.45...0.56 N•m (4...5 lb•in)
1000	 GND			14...10 AWG	1.13...1.36 N•m (10...12 lb•in)

On most PanelView Plus DC terminals, the earth/ground terminal is internally connected to the DC- terminal within the product.

ATTENTION



Damage or malfunction can occur when a voltage potential exists between two separate ground points. Make sure the terminal does not serve as a conductive path between ground points at different potentials.

The PanelView Plus terminals have isolated and nonisolated communication ports. Refer to [Communication Port Isolation](#) page [88](#) for details.

IMPORTANT

For more information, refer to Wiring and Grounding Guidelines for PanelView Plus Devices, publication [2711P-TD001](#).

Connect DC Power

WARNING



Explosion Hazard - Do not disconnect equipment unless power has been switched off and area is known to be nonhazardous.

Disconnect all power before installing or replacing components. Failure to disconnect power may result in electrical shock or damage to the terminal.

Follow these steps to connect the terminal to DC power.

1. Verify that the terminal is not connected to a power source.
2. Secure the DC power wires to the terminal block.
Follow the markings on terminal blocks and terminal for proper connections.
3. Secure the earth/ground wire.
 - On 400 and 600 terminals, secure the earth/ground wire to the functional earth/ground terminal on the input power terminal block.
 - On the 1000 terminal, secure the earth/ground wire to the earth/ground terminal screw at the bottom of the display.

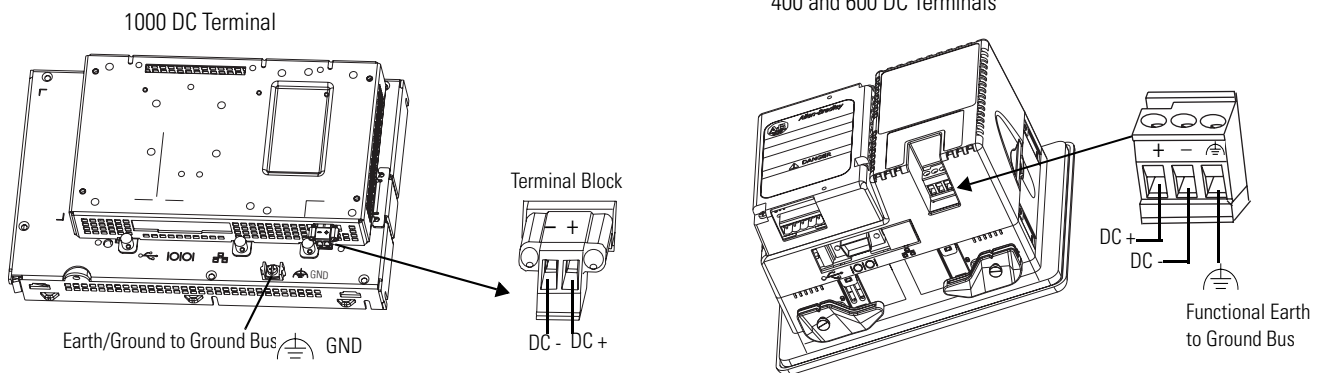

4. Apply 24V DC power to the terminal.

Resetting the Terminals

Use the reset switch to restart a terminal without having to disconnect and reapply power. After a reset, the terminal performs a series of startup tests and then either:

- runs the .MER application loaded in the terminal.
- enters Configuration mode.

The action that occurs depends on the startup options configured for your terminal. Refer to page [60](#) for information on startup options.

Refer to [Chapter 8, Troubleshooting](#), for a list of startup information and error messages.

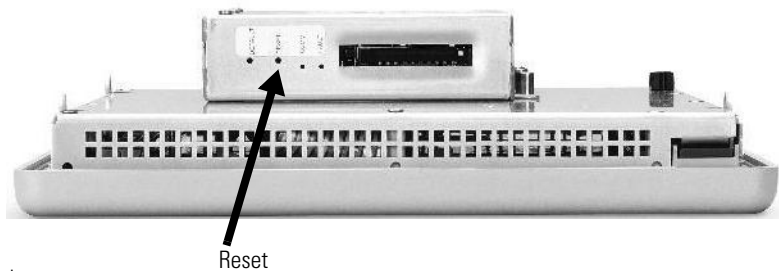
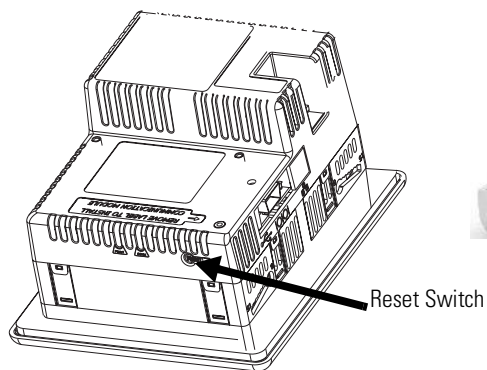

- On 400 and 600 terminals, press the reset switch with your finger or a nonconductive object.
- On 1000 terminals, insert a thin, nonconductive probe into the hole marked reset and press the switch.

ATTENTION



Use a nonconductive object to press the reset or default switch. Do not use a conducting object such as a paper clip or you may damage the terminal. Do not use the tip of a pencil; graphite may damage the terminal.

Configuring the Terminal

Chapter Objectives

This chapter shows how to use the Configuration mode of your terminal to:

- perform data entry and navigation.
- load an application.
- run an application.
- modify application settings.
- modify terminal settings.

Accessing Configuration Mode

Your terminal has onboard software, FactoryTalk View ME Station, to perform and configure terminal operations. When you reset or start the terminal, you automatically enter Configuration mode, unless your .MER application is automatically set to run on startup.

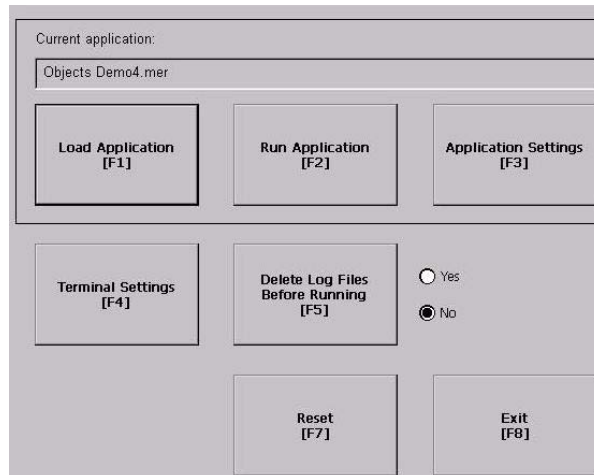

To access Configuration mode from a running application, press the Goto Configuration Mode button. The application stops running but is still loaded.

IMPORTANT

To access Configuration mode from a running application, you must add a Goto Configuration Mode button to an application screen in FactoryTalk View Studio software.

Configuration Mode

Name of application that is currently loaded.
Only appears if application is loaded.

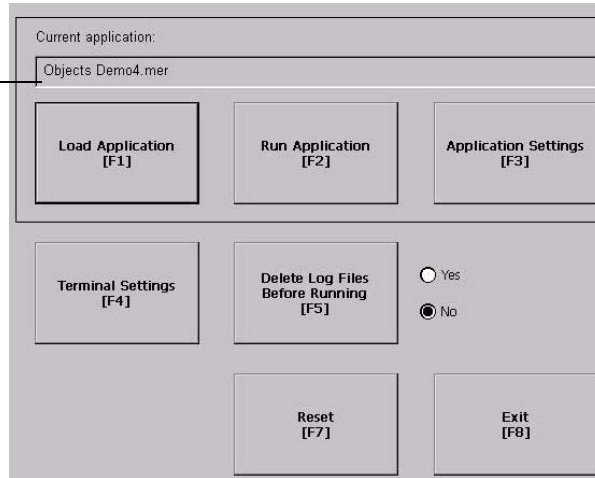





Terminal Operation	Description
Load Application (F1)	Opens another screen where you can select an application to load. Once loaded, the application name will appear under Current Application.
Run Application (F2)	Runs the .mer application displayed under Current Application. An application must be loaded before you can run it.
Application Settings (F3)	Opens a menu of application-specific configuration settings.
Terminal Settings (F4)	Opens a menu of options to configure non-application, specific terminal settings.
Delete Log Files Before Running (F5)	Toggles between Yes and No. If you select Yes, all data log files, alarm history and alarm status file will be deleted before the application is run. If you select No, log files are not deleted first.
Reset (F7)	Resets the terminal. The action on startup depends on how you configure the startup option.
Exit (F8)	Exits Configuration mode.

Navigation Buttons

Screen buttons are used for data entry and navigation.

- On touch-screen terminals, tap the button with your finger or stylus.
- On keypad terminals, select the function key listed on the button, or in some cases, the corresponding key on the keypad.
- If a mouse is attached, click a button.

In addition to operation specific buttons, most screens have a combination of these buttons.

Navigation Buttons	Description
	Returns to the previous screen.
	Accepts modified values and returns to previous screen.
	Cancels the current operation without saving any changes.
	Moves highlight up or down a list.
	Selects a highlighted screen or item from a list.

Enter or Edit Data

Many screens have buttons that access fields where you must enter or edit data. When you press the button or function key, the input panel opens ready for you to enter data. If a field is restricted to a numeric value, only the 0...9 keys will be enabled. If the value is an IP address, the 0...9 and decimal point keys will be enabled.

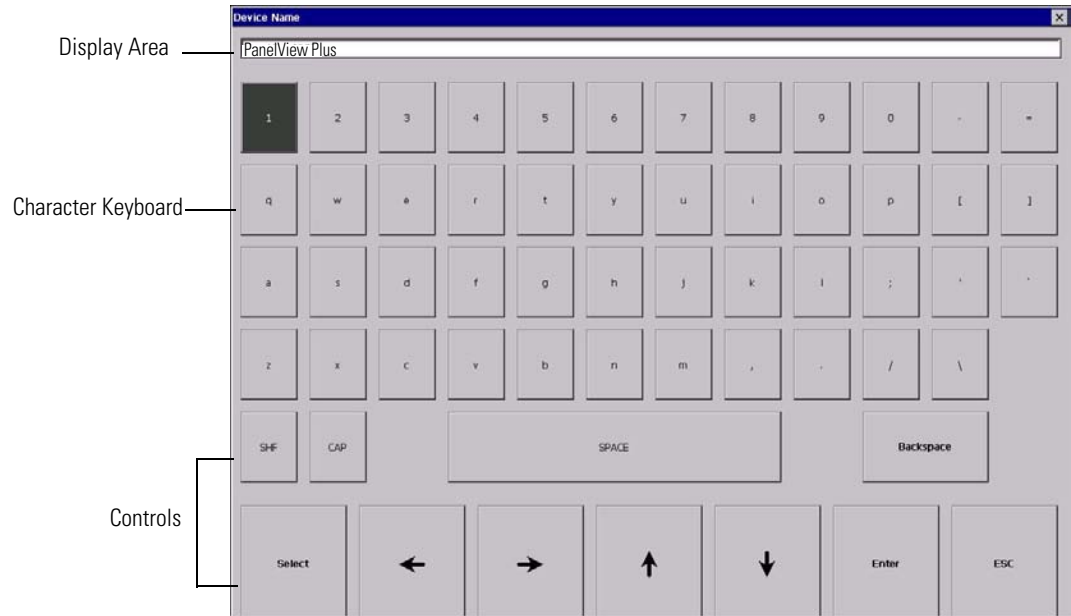

Input Panel Controls	Function
SHF	Switches keys between their shifted and unshifted state. The initial default is shifted.
CAPS	Switches keys between lowercase and uppercase characters. The initial default is lowercase.
SPACE	Enters a space between characters in the Display Area.
Backspace	Deletes the previous character (to the left of the cursor) in the Display Area.
Select	Selects a character and enters it in the Display Area.
Right, Left, Up, Down Arrow Keys	Selects the character to the right, left, above or below the currently selected character.
Enter	Accepts the entered characters and returns to the previous screen
ESC	Cancels the current operation and returns to the previous screen.

Follow these steps to enter characters in the display area.

1. Select a character on the character keyboard.
 - On a touch-screen terminal, tap or press a key.
 - On a keypad terminal, use the arrow keys on the keypad to select a key.
 - If a mouse is attached, click a key.
2. Press the Select button to copy the character to the display area.
3. Press Enter when done to exit the input panel.

Loading an Application

You can load a FactoryTalk View ME .MER application from internal CompactFlash in the terminal or an external CompactFlash card.

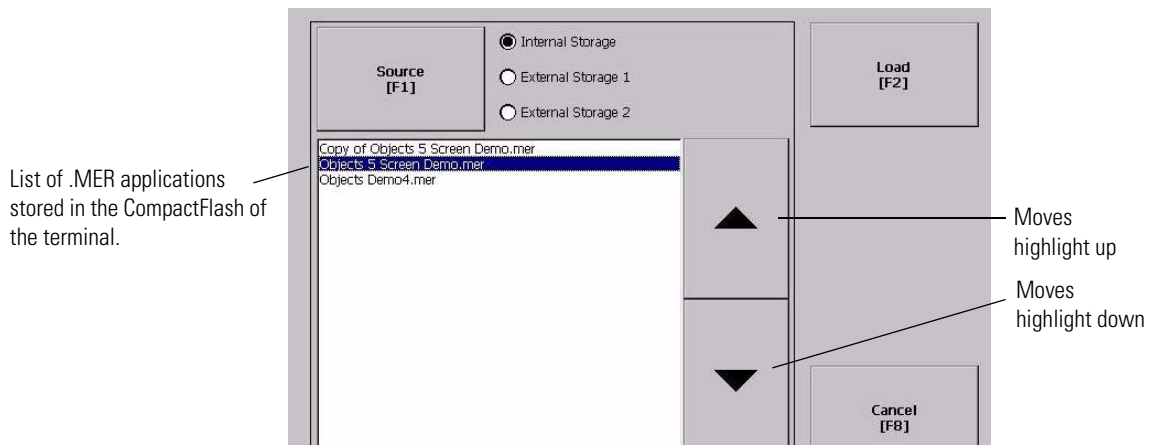

Follows these steps to load an application:

1. Select Load Application from the main screen.
2. Press the Source button to select the storage location of the application file you want to load.
 - Internal Storage - internal CompactFlash in the terminal.
 - External Storage 1 - external CompactFlash card loaded in the card slot of the terminal.
 - External Storage 2 - reserved for future use.

TIP

FactoryTalk View ME software only recognizes files in the \Rockwell Software\RSViewMERuntime\ folder.

3. Select an .MER file from the list by using the up and down cursor keys.
4. Press the Load button to load the selected application.

You are asked if you want to replace the terminal's communication configuration with the communication settings in the application.
5. Select Yes or No.

If you select Yes, any changes to the device addresses or driver properties in the RSLinx Communication screen will be lost.

The name of the currently loaded application will appear at the top of the main configuration screen.

If you try to load a regular Machine Edition application created for a PanelView Plus application on a PanelView Compact terminal, an error is generated.

Error: Unable to load non-Compact Machine Edition application. Please load a compact Machine Edition application.

IMPORTANT

You can only load a Compact Machine Edition application on a PanelView Plus Compact terminal.

Running an Application

After loading an .MER application, you can run the application. To load an application, select the Run Application button on the main screen.

Log files are generated by the application. To delete the log files before running an application, select the Delete Log Files Before Running button on the main screen.

Application Settings

You can show device shortcuts defined for the loaded .MER application. For example, your .MER application might have SLC defined as a device shortcut name for the SLC 5/05 controller. Device shortcuts are read-only and cannot be edited. To view device shortcuts, select the Application Settings button from the main screen.

Terminal Settings

You can modify settings on the terminal that are not specific to the application.

Terminal Settings	Description
Diagnostics	Forwards diagnostic messages from a remote log destination to a computer running diagnostics.
Display	Shows the temperature of the display, sets the intensity of the backlight, and enables/disables the screen saver.
File Management	Copies or deletes application files or font files from a storage location.
Font Linking	Links a font file to a base font loaded on the terminal.
Input Devices	Configures settings for the keypad, touch screen, or attached keyboard and mouse.
Networks and Communications	Configures network connections and communication settings specific to the application.
Print Setup	Configures settings for printing displays, alarm messages, and diagnostics messages generated by the application.
Startup Options	Specifies whether the terminal starts up in configure or run mode. Also lets you enable/disable tests to run on the terminal at startup.
System Event Log	Displays a list of system events currently logged by the terminal.
System Information	Displays power, temperature, battery and memory details for the terminal. Also shows the firmware number for FactoryTalk View ME software and technical support information.
Time/Date/Regional Settings	Sets the date, time, language, and numeric format used by the terminal and applications.

Follow these steps to access terminal settings and select a function.

1. Select Terminal Settings from the main screen.

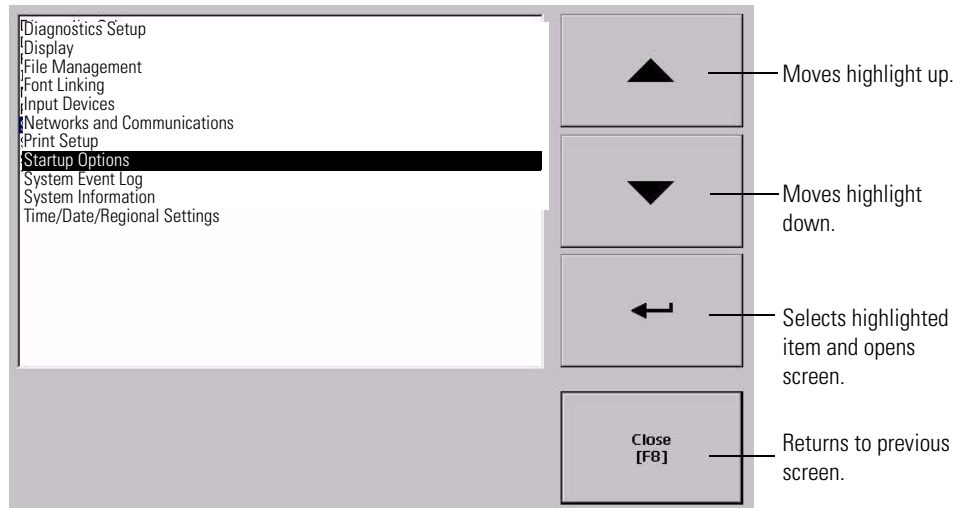

2. Highlight an option by using the up and down cursor buttons.
 - On touch screen terminals, press the buttons.
 - On keypad terminals, press a key on the keypad or the corresponding function key.
3. Press the Enter key to access the highlighted function.

Configuring Communication You configure communication for your application and controller by using RSLinx Enterprise software.

- Access KEPServer Serial Port ID's.
- Edit or view the driver settings for the communication protocol used by your .MER application.
- Edit the device address of the controller on the network.

KEPServer Serial Port ID's

To access the KEPServer Serial Port ID's screen, you must have KEPServer Enterprise installed on your terminal. Otherwise, you will get an error message when accessing this screen. If you plan on using KEPServer Enterprise and serial communication, you must specify which COM port to use.

To access the KEPServer Serial Port ID screen, select Terminal Settings>Networks and Communications>KEPServer Serial Port ID's.

Configure Communication Properties

Follow these steps to configure driver settings for the communication protocol used by your application.

1. Select Terminal Settings>Networks and Communications>RSLinx Enterprise Communications.

You see a tree view of installed communication cards and network configurations.

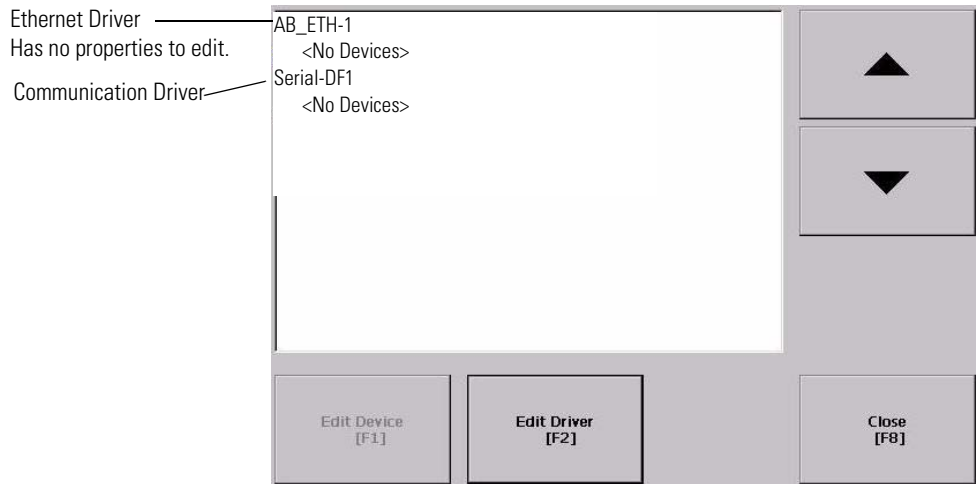

2. Select the communication card installed on your terminal.

3. Press the Edit Driver button to view the current properties for the communication driver.

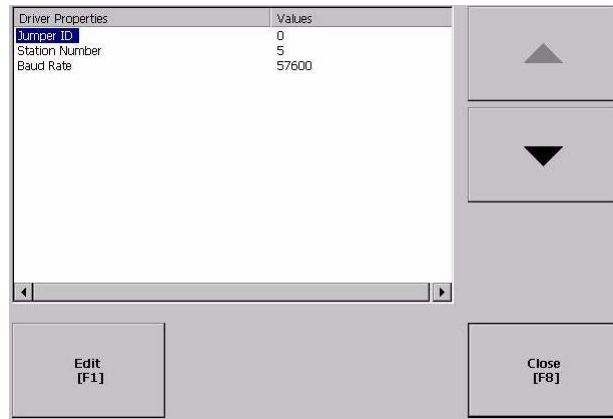

4. Select the property you want to modify, then press the Edit button.

5. Modify the setting and then press the Enter button.

You return to the previous screen with the newly entered data.

Serial Properties

Field	Description	Valid Values
Device	The serial device your terminal is connected to.	PLC_CHO KF2 SLC_CHO KF3 KFC KFC15 AC_CHO
Error Check	Type of error checking used. Error checking is automatically configured if Use Auto Config is set to Yes.	BCC, CRC
Parity	Type of parity used. The parity is automatically configured if Use Auto Config is set to Yes.	None, Odd, Even
Stop Bits	Number of stop bits used.	1 or 2
Ack Timeout	Ack/Poll timeout value in ms.	20...60,000 ms
Max Retries	Maximum number of retries before the serial driver fails.	0...255
Station	Station number based on a specific device.	PLC_CHO 0...77 (octal) KF2 0...77 (octal) SLC_CHO 0...31 KF3 0...31 KFC 1...99 KFC15 1...99 AC_CHO 0...255
Baud Rate	Data rate at which serial driver communicates. The baud rate is automatically configured if Use Auto Config is set to Yes.	110 300 600 1200 4800 9600 19,200 38,400 115,200
Use Auto Config	Automatically or manually configures the baud rate, parity, and error checking parameters.	Yes (auto configure) No (manual configure)
Com Port	Communication port used on the terminal.	1 (COM1) 2 (COM2)

Configure the Controller Address

Follow these steps to edit the device address of the logic controller.

1. From the RSLinx Configuration screen, select a device node.
2. Press the Edit Device button to view the device name and current address of the logic controller.

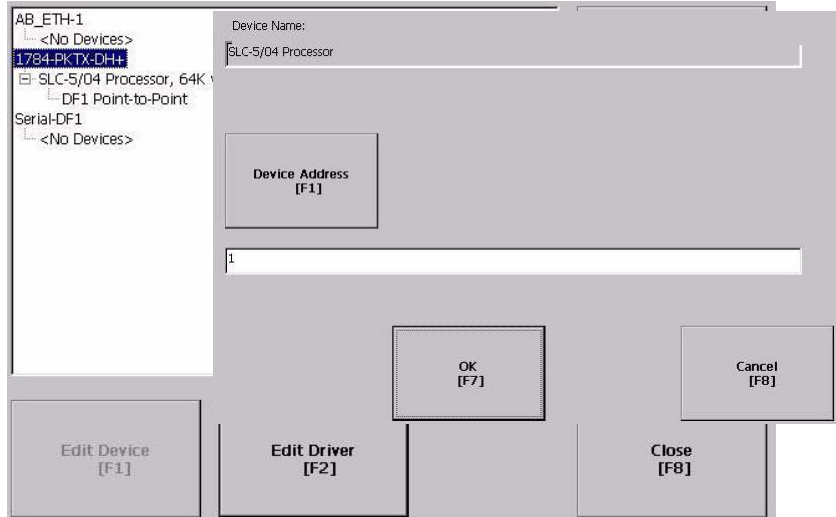

3. Press the Device Address button to modify the address.

The input panel opens with the current address.

4. Use the Input Panel to modify the address and then press the Enter button.

You return to the previous screen with the new address.

5. Press OK.

IMPORTANT

Modified settings do not take effect until the terminal is restarted.

Configuring Network Information

You can configure network information for your terminal.

- Device name to identify terminal on network
- IP address of terminal on network
- Username and password to access network resources

Define a Device Name for the Terminal

You can configure a device name and description to identify your your terminal on the network.

Follow these steps to enter a device name and description for your terminal.

1. Select Terminal Settings>Networks and Communications>Network Connections>Device Name.

2. Press the Device Name button to enter or edit the device name.
3. Press the Device Description button to enter or edit the description for the device.

Field	Description	Valid Values
Device Name ⁽¹⁾	Name that identifies the terminal to other computers on the network.	1...15 characters A leading character in the range of a through z or A through Z. Remaining characters in the range of a through z, A through Z, 0...9, or - (hyphen)
Device Description	Provides a description of the terminal.	50 characters max

⁽¹⁾ Check with your network administrator to determine a valid device name.

4. Press OK.

Define an Ethernet IP Address

Some networks automatically assign IP addresses to Ethernet devices if DHCP is enabled. If DHCP is not enabled, you can manually enter an IP address for the terminal.

Follow these steps to view or enter an IP address for your terminal.

1. Select Terminal Settings>Networks and Communications>Network Connections>Network Adapters.

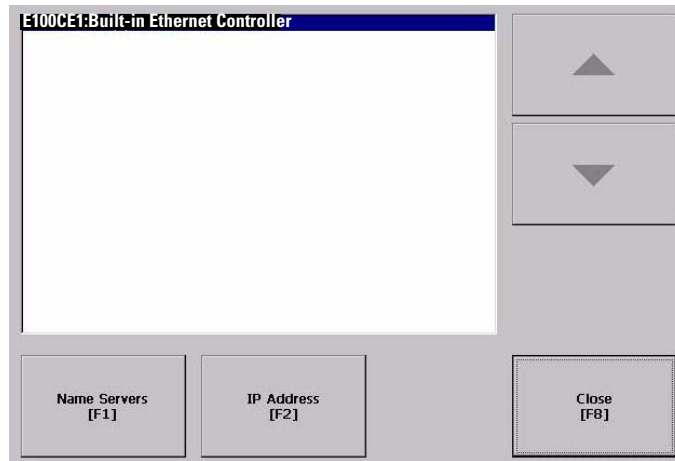

2. Press the IP Address button to view or modify the IP address.

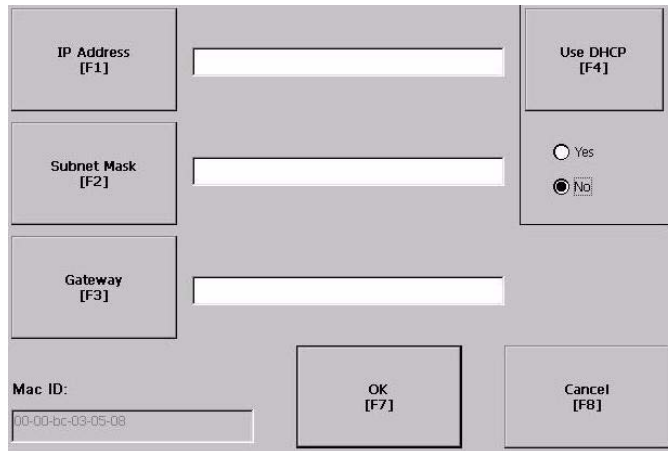

3. Press the DHCP button to enable or disable DHCP assignment of addresses.
4. Press the IP address, Subnet Mask, and Gateway buttons, then enter the appropriate information.
5. Press OK when done.

Field	Description	Valid Values
Use DHCP	<p>Enables or disables Dynamic Host Configuration Protocol (DHCP) settings. DHCP automatically allocates network devices and configurations to newly attached devices on the network.</p> <p>If DHCP is set to Yes, the terminal is automatically assigned an IP address, Subnet Mask, and Gateway. The fields are disabled.</p> <p>If DHCP is set to No, you can enter the IP address, Subnet Mask, and Gateway address.</p>	Yes (default) No
IP Address	A unique address identifying the terminal on the Ethernet network.	xxx.xxx.xxx.xxx 000.000.000.000 (default) Range of values for the first set of decimal numbers is 1...255 unless all fields are set to 000. The range of values for the last three sets of decimal numbers is 0...255.
Subnet Mask	Address must be identical to the server subnet mask.	xxx.xxx.xxx.xxx
Gateway	Optional Gateway address.	xxx.xxx.xxx.xxx
Mac ID	Read-only field.	

Define Name Server Addresses

You can define name server addresses for the EtherNet/IP network adapter. These addresses are automatically assigned if DHCP is enabled for the network adapter.

The image shows a dialog box with a light gray background. It has four input fields arranged in a 2x2 grid. The top-left field is labeled 'Primary DNS [F1]', the top-right is 'Primary WINS [F2]', the bottom-left is 'Secondary DNS [F3]', and the bottom-right is 'Secondary WINS [F2]'. Each field has a white text box. At the bottom of the dialog, there are two buttons: 'OK [F7]' on the left and 'Cancel [F8]' on the right.

Follow these steps to define name server address.

1. Select Terminal Settings>Networks and Communications>Network Connections>Network Adapters.
2. Press a button to enter a name server address.

Field	Description	Valid Values
Primary DNS	The address of the primary DNS resolver.	xxx.xxx.xxx.xxx
Secondary DNS	The address of the secondary DNS resolver.	xxx.xxx.xxx.xxx
Primary WINS	The address of the primary WINS resolver.	xxx.xxx.xxx.xxx
Secondary WINS	The address of the secondary WINS resolver.	xxx.xxx.xxx.xxx

3. Press OK when done.

Authorize Terminal to Access Network Resources

The terminal can access network resources with proper identification. A user name, password, and domain must be provided by your network administrator.

1. Select Terminal Settings>Networks and Communications>Network Connections>Network Identification.

2. Press the user name, password and domain buttons and enter the information provided by your network administrator.

Field	Description	Valid Values
User Name	Identifies the user to the network.	70 characters max
Password	Characters that gain access to network along with the user name.	No character limitation
Domain Name	Provided by network administrator.	15 characters max

3. Press OK when done.

Configuring Diagnostics

You can configure diagnostics for the current computer. To access the diagnostic screen, select Terminal Settings>Diagnostic Setup from the main screen. The screen shows a tree view of diagnostic nodes.

To access the Remote Log Setup or Message Routing, select the node and then the Edit button.

Remote Log Destination

The Remote Log Destination forwards messages that it receives to a Windows 2000/XP computer running diagnostics. The location is determined by the IP address and port number.

Field	Description	Valid Values
Address	Address of the remote Windows 2000/XP computer.	xxx.xxx.xxx.xxx
Port	The port used to communicate with the remote Windows 2000/XP computer.	4445 (default)

Message Routing

The Message Routing screen lets you access these screens:

- Remote Log
- FactoryTalk View Diagnostics List

Each of the above screens shows a list of messages that can be sent to that destination. The list shows the On/Off status of each message type. Use the On/Off button to turn a message type on or off. A message type is enabled if it has a checked box.

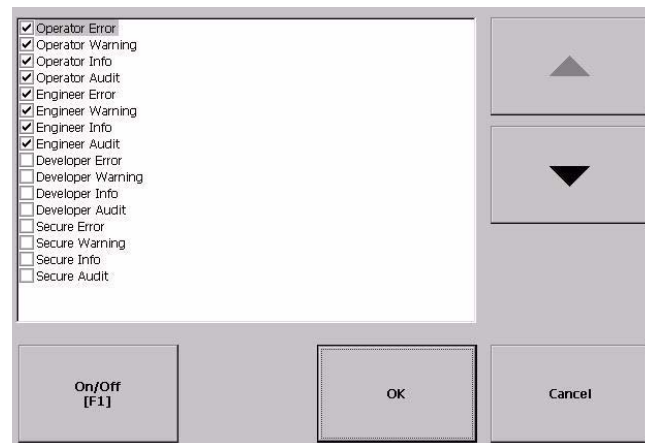

Managing Files on the Terminal

The terminal provides operations for managing files that are stored on the terminal.

- Delete application .MER files, font files, or log files that reside in a storage location on the terminal.
- Copy application .MER files or font files from one storage location to another.

Delete an Application File or a Font File

The procedure for deleting an application file or a font file from the terminal is the same except for the type of file you are deleting.

1. Select Terminal Settings>File Management>Delete Files>Delete Applications or Delete Fonts.
2. Press the Source button to choose the storage location of the application or font file you want to delete.
 - Internal Storage - the internal CompactFlash in the terminal.
 - External Storage 1 - the external CompactFlash card loaded in the card slot of the terminal.
 - External Storage 2 - for future use.

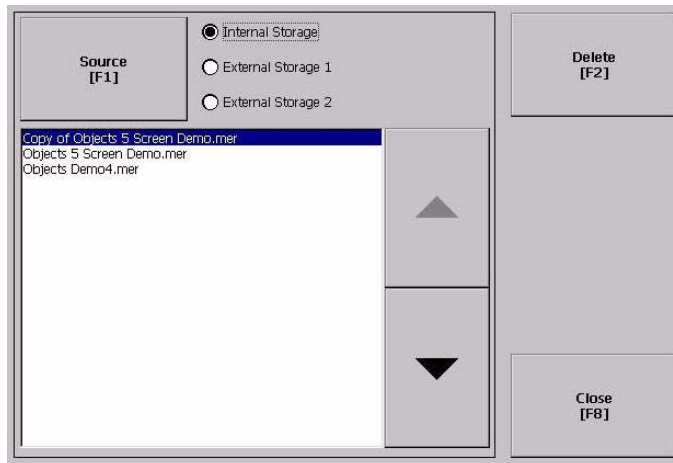

3. Select a file from the list.
4. Press the Delete button.
5. Select Yes or No when asked if you want to delete the selected application or font file from the storage location.

Delete Log Files from Terminal

You can delete log files, alarm history files, and alarm status files from the System Default location on the terminal.

1. Select Terminal Settings>File Management>Delete Files>Delete Log Files.

You are asked to confirm the deletion of the files.

2. Select Yes or No.

Only log files in the System Default location are deleted.

Copy an Application File or Font File

The procedure for copying an application .MER file or a font file from one storage location on the terminal to another is the same.

1. Select Terminal Settings>File Management>Copy Files>Copy Applications or Copy Fonts.

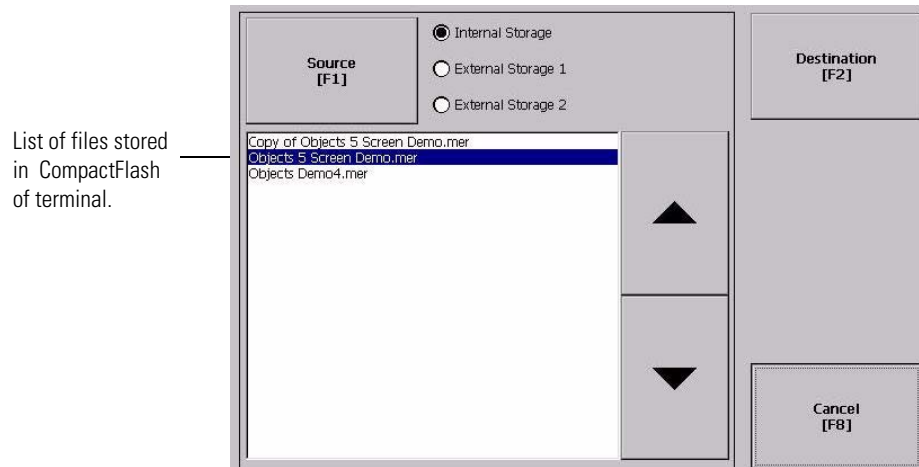

2. Press the Source button to choose the location of the application or font file you want to copy.
 - Internal Storage - the internal CompactFlash in the terminal.
 - External Storage 1 - the external CompactFlash card loaded in the card slot of the terminal.
 - External Storage 2 - for future use.
3. Select a file from the storage location.
4. Press the Destination button on the same screen.

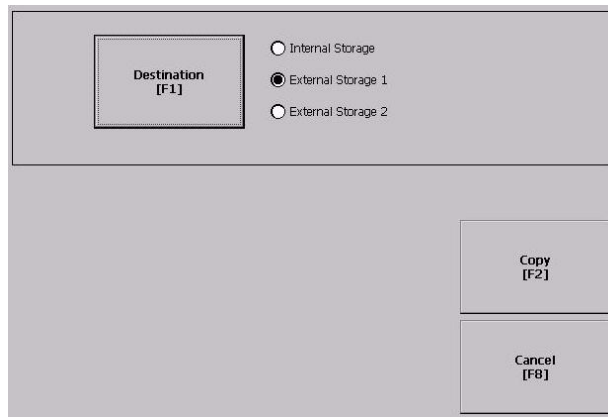

5. Press the Destination button to choose the storage location where you want to copy the application or font file.
The destination must be different than the source location.
 - Internal Storage - the internal CompactFlash in the terminal.
 - External Storage 1 - the external CompactFlash card loaded in the card slot of the terminal.
 - External Storage 2 - for future use.
6. Press the Copy button to copy the selected application or font file to the selected destination.
If the file exists, you will receive a warning and will be asked if you want to overwrite the existing application.
7. Select Yes or No.

TIP

FactoryTalk View ME software looks for .MER files in the \Rockwell Software\RSViewME\Runtime folder and font files in the \Rockwell Software\RSViewME\Fonts\ folder.

Modifying Display Settings

You can access and modify these display settings for your terminal:

- View display temperature
- Adjust display contrast
- Adjust display intensity
- Configure the screen saver
- Enable or disable the screen cursor

View the Display Temperature

To view the current temperature of the display, select Terminal Settings>Display>Display Temperature.



The 600 and 1000 terminals have a cold-cathode fluorescent lamp (CCFL) backlight. This backlight requires temperature control when the internal temperature of the product is below 10 °C (50 °F) or above 60 °C (140 °F). The terminal monitors low and high temperature conditions.

- If the internal temperature of the product is below 10 °C (50 °F), the backlight is set to overdrive or the full-rated current setting for at least five minutes.
- If the internal temperature is at or above 60 °C (50 °F), the backlight is set to underdrive; 40% or less of full brightness. This reduces heat generation from the backlight.

Temperature monitoring begins when the terminal powers on, or when the backlight turns on, for example, exiting Screen Saver mode. The temperature control affects only display intensity; it does not restrict the use or operation of the terminal.

When a low or high temperature condition is detected, an error is sent to the system event log. If the temperature control is not functioning, a noncritical error is sent to the system event log but the terminal continues to operate normally.

TIP

The CCFL backlight temperature control takes precedence over the application Backlight Settings.

Adjust the Display Contrast

You can view or modify the display contrast for 400 and 600 grayscale terminals. Displays are shipped with the contrast level set at 50%, which is the optimum setting.

1. Select Terminal Settings>Display>Display Contrast.

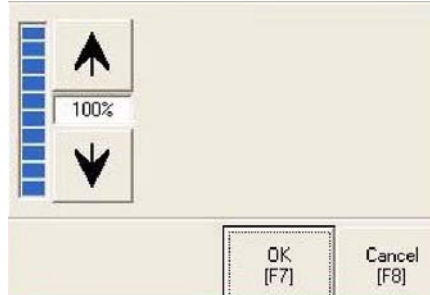

2. Press the up and down cursor buttons to adjust the contrast.
The current contrast level is shown as a percentage. The change is not permanent until you press OK.
3. Press OK when done.

Adjust the Display Intensity

You can view or modify the intensity of the terminal backlight. You can use the default intensity of 100% or you can set the intensity for runtime operations.

1. Select Terminal Settings>Display>Display Intensity.

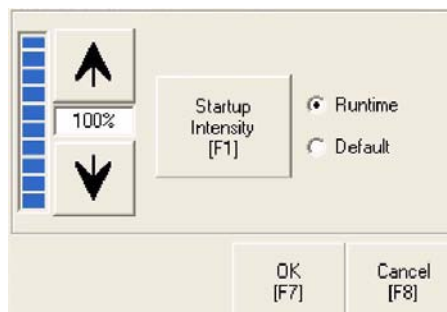

2. Press the Startup Intensity button to switch between the Default intensity and the Runtime intensity.
 - If you choose Runtime, the startup screens will use the runtime intensity.
 - If you choose Default, the startup screens will use the default setting of 100%
3. Increase or decrease the intensity for runtime operations, by pressing the up or down arrow keys.
Intensity changes are not permanent until you press OK.
4. Press OK when done.

Configure the Screen Saver

The terminal screen saver activates after an idle period using a specific intensity. You can adjust the idle timeout and intensity, disable the screen saver, and enable or disable the screen saver bitmap.

1. Select Terminal Settings>Display>Screen Saver.

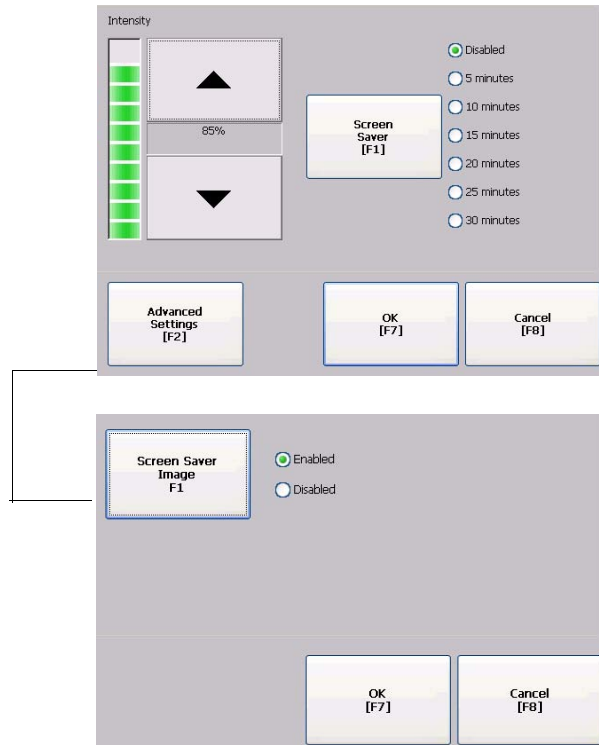

2. Press the Screen Saver button to select an idle timeout for activating the screen saver.
To disable the screen saver, select the Disabled option.
3. Increase or decrease the brightness intensity of the screen saver by pressing the up and down cursor buttons.
4. Press the Advanced Settings button to access the bitmap option.
 - Select the Screen Saver Image button to enable or disable the screen saver bitmap.
 - Press OK to return to the previous.
5. Press OK to exit and return to the terminal settings.

Enable or Disable the Screen Cursor

The terminal has a screen cursor that you can enable or disable.

1. Select Terminal Settings>Display>Cursor.

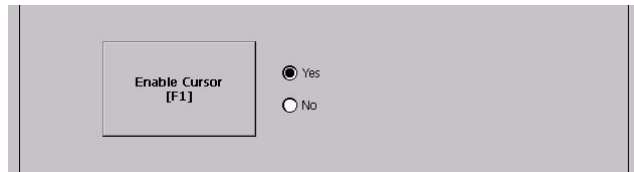

2. Press the Enable Cursor button to enable or disable the cursor.
3. Press OK to exit and return to Terminal Settings.

Font Linking

Font linking lets you run a translated application on the terminal by linking a font file to the base font, for example, linking a Chinese font file to the base font Arial.

For more details on pre-installed terminal fonts and additional fonts available for downloading, see [Appendix C](#).

To link a font file to the base font on the terminal, select Terminal Settings>Font Linking.

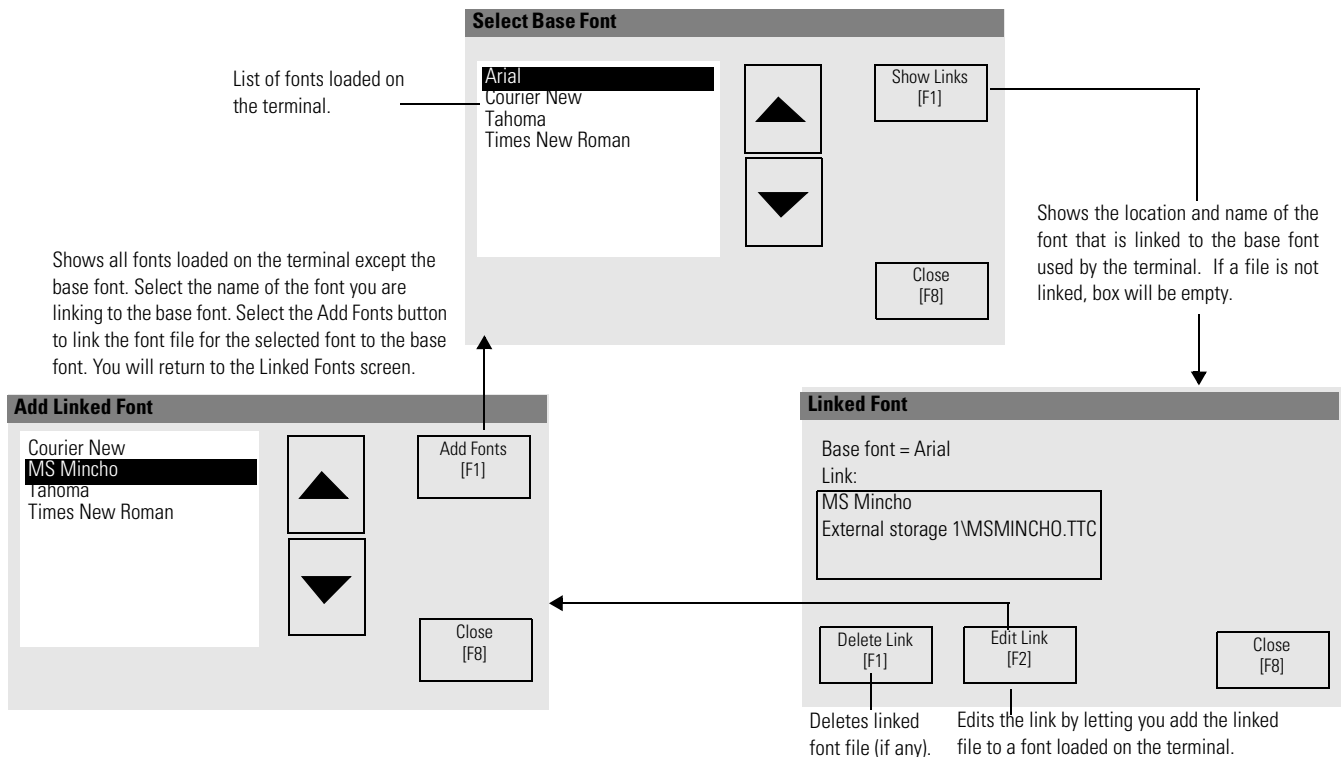

Configuring the Keypad, Keyboard, or Mouse

You can configure input devices used with your terminal, including the keyboard, keypad, mouse, and attached keyboard.

Configure Keyboard Settings

You can adjust settings for the keys on the terminal keypad or for keys on an attached keyboard.

1. Select Terminal Settings>Input Devices>Keyboard.

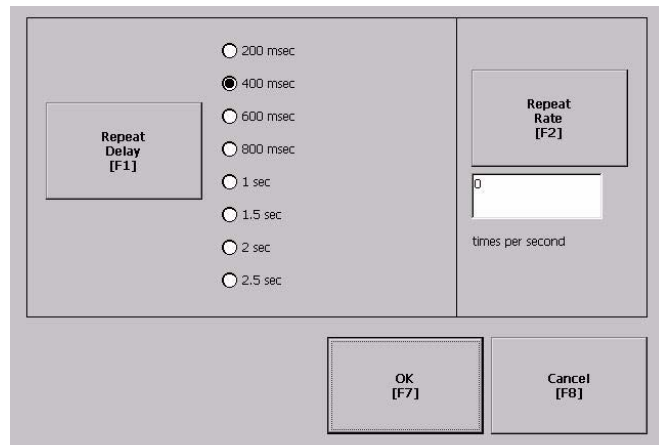

2. Press the Repeat Rate button to specify the number of times a key is repeated per second when you hold a key down.
Valid values for the keypad are 0 and 2...30. The keyboard is device dependent but typical values are the same.
3. Press the Repeat Delay button to select the amount of time that elapses per second before a key is repeated.
Values are device dependent. Unsupported values are dimmed.
4. Press OK when done.

Configure Keypad Settings for the Terminal

You can restrict multiple or simultaneous key presses on the keypad of your terminal.

1. Select Terminal Settings>Input Devices>Keypad.

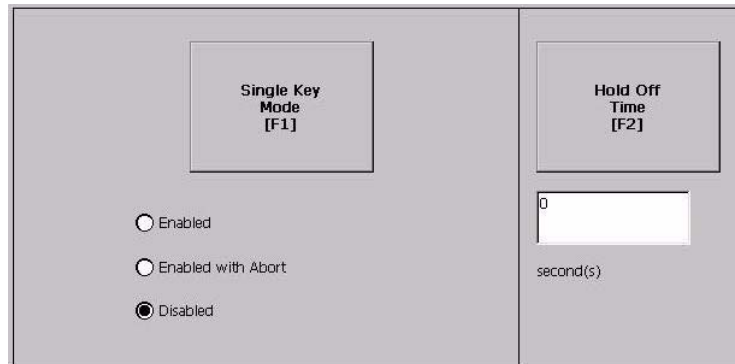

2. Press the Single Key Mode button to select a key option.
 - If Enabled, any programmable key that is pressed inhibits all keys until the programmable key is pressed again. This includes the Alt, Ctrl, Shift keys.
 - If Enabled with Abort, any secondary key press will terminate the initial key press immediately.
 - If Disabled, there are no restrictions on key presses. This is the default.

IMPORTANT

The keypad cannot produce Home, End, Page Up or Page Down when Single Key mode is enabled.

3. Press the Hold Off Time button to enter the length of time, in seconds, to ignore multiple presses of the same key.
4. Press OK when done.

Configure the Sensitivity of the Mouse

You can set and test the sensitivity for both the speed and physical distance between mouse clicks. The process is identical to setting the double-tap sensitivity for the touch screen.

To set the mouse sensitivity, select Terminal Settings>Input Devices>Mouse.

Configuring the Touch Screen

You can configure these operations for terminals with a touch screen:

- Calibrate the touch screen
- Enable or disable Cursor
- Set the double-tap sensitivity

Calibrate the Touch-screen

IMPORTANT

Use a plastic stylus device with a minimum tip radius of 1.3 mm (0.051 in.) to prevent damage to the touch screen.

Follow these steps to calibrate the touch screen.

1. Select Terminal Settings>Input Devices>Touch Screen>Calibration.

The screen for calibrating the touch screen appears.

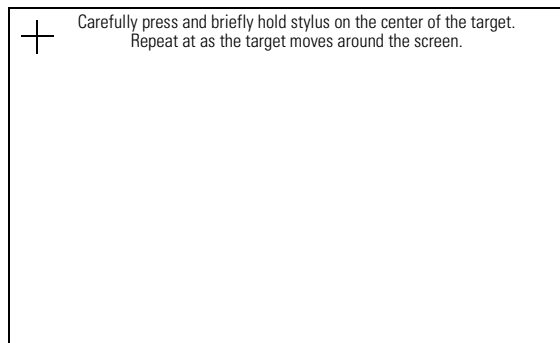

2. Touch the center of the target (+) each of the four times it appears on the screen.

When the calibration is complete, you will see this message.

Tap the screen to register saved data. Wait for 30 seconds to cancel saved data and keep the current settings.

3. Tap the screen to save the data or wait 30 seconds to cancel the saved data, retaining the current settings.

Enable or Disable the Cursor on Touch Screens

You can enable or disable the cursor on terminals with a touch screen. Disabling the cursor will not disable the mouse.

1. Select Terminal Settings>Input Devices>Touch Screen>Cursor.

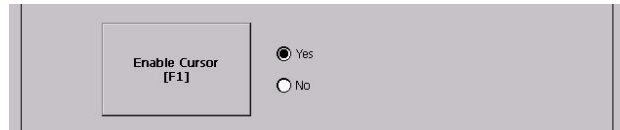

2. Press the Enable Cursor button to enable or disable the cursor.
3. Press OK.

Set the Double-tap Sensitivity

You can set and test the sensitivity for both the speed and physical distance between touch-screen presses. The process is identical to setting the double-tap sensitivity for the mouse.

1. Select Terminal Settings>Input Devices>Touch Screen>Double-tap Sensitivity.

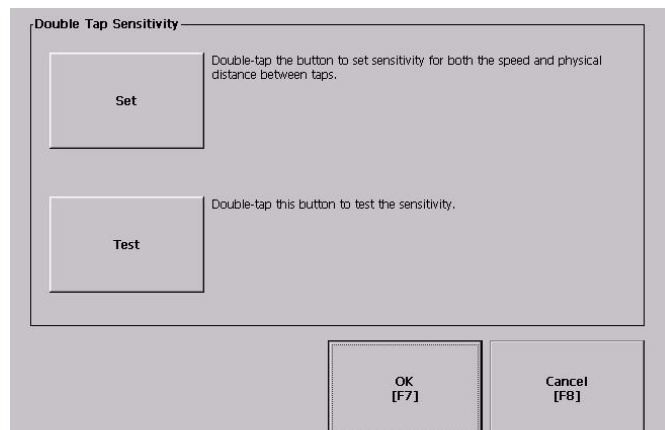

2. Double-tap the Set button to set the sensitivity of touch-screen presses.
3. Double-tap the Test button to test the sensitivity of touch-screen presses.

If you double-tap the test button with the time set using the Set button, the Test button will reverse its foreground and background colors.

4. Press OK when done.

Configuring Print Options

You can configure settings for printing displays, alarm messages, or diagnostic messages from FactoryTalk View ME .MER applications. The general setup for printing displays and messages is the same, however, the advanced settings are different.

1. Select a Terminal Settings>Networks and Communications>Print Setup> option.
 - Displays
 - Alarms
 - Diagnostic Messages

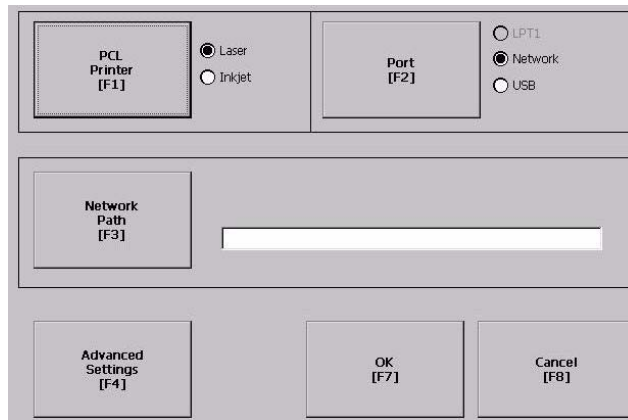

2. Update properties by selecting the appropriate button and changing the value, if necessary.

Field	Description	Valid Values
PCL Printer	Type of printer to use.	Laser (default) Inkjet
Port	Port to use for printing displays, alarm messages, and diagnostic messages.	Network (default) USB
Network Path	Network path of printer to use if the Port selection is Network.	519 characters max
Advanced Settings	Accesses additional settings.	

3. Press the Advanced button to access additional settings.

The advanced settings for printing displays are:

- print orientation (portrait or landscape).
- draft mode (enable or disable).

- The advanced settings for printing diagnostic and alarm messages determines when to print messages that are sent to the network or USB port.

Print Messages After	Default Value	Example
Specified number of messages	60 messages	When the queue has 60 messages, the messages are printed regardless of how long they have been in the queue. You can change the number of messages.
500 messages or timeout period, whichever is first	168 hours (7 days)	If the queue has 350 messages after 168 hours, the 350 messages are printed. You can change the timeout period.
Specified number of messages or timeout period, whichever is first.	60 messages 168 hours (7 days)	If the queue has 60 messages after 24 hours, then the 60 messages are printed. You can change the number of messages and the timeout period. For example, the number of messages is set to 75 and the timeout period is set to 48 hours. <ul style="list-style-type: none"> • If the queue has 75 messages after 24 hours, then the 75 messages are printed before the set timeout of 48 hours. • If the queue has 15 messages after 48 hours, the 15 messages are printed after the set timeout period.

4. Press OK when done.
5. Press OK to return to Terminal Settings.

Configuring Startup Options

The action the terminal takes on startup depends on how you configure the startup options. You can:

- disable FactoryTalk View ME Station software.
- go to FactoryTalk View Configure mode.
- run the current application.

Disable FactoryTalk View ME Station Software on Startup

Follow these steps to disable FactoryTalk View Station software on startup.

1. Select Terminal Settings>Startup Options>FactoryTalk View ME Station Startup.

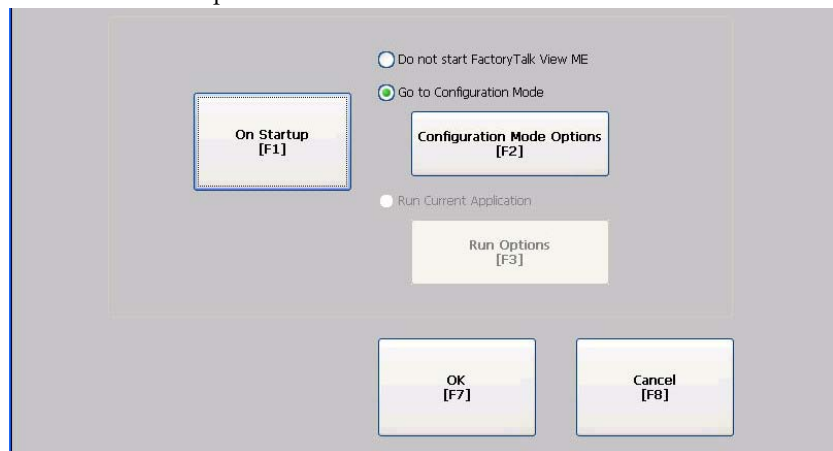

2. Press the On Startup button until Do not start FactoryTalk View ME is selected.
3. Press OK.

Enter Configuration Mode on Startup

Follow these steps to enter Configuration mode on startup.

1. Select Terminal Settings>Startup Options>FactoryTalk View ME Station Startup.

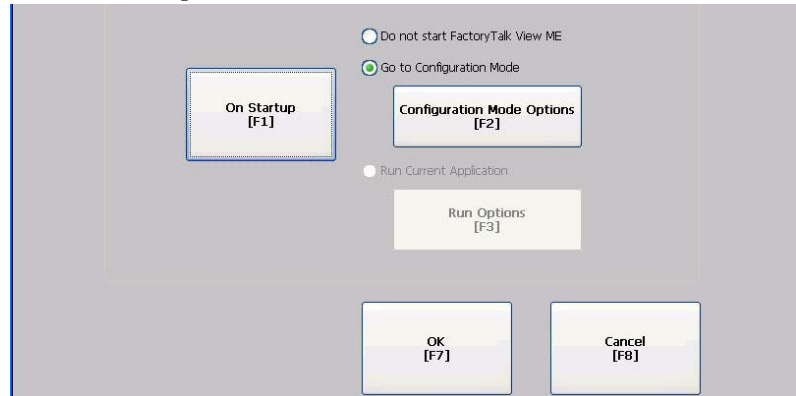

2. Press the On Startup button to select Go to Configuration Mode.
3. Press the Configuration Mode Options button.

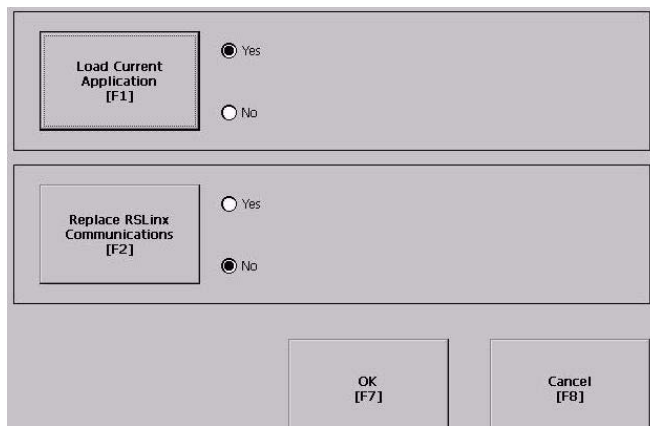

4. Press the Load Current Application button to specify whether you want to load the current application on startup.
5. Press the Replace RSLinx Communications button to specify whether to use the communication configuration of the current application or the terminal on startup.
 - Select No to use the RSLinx configuration of the terminal.
 - Select Yes to use the configuration of the application. The terminal configuration is replaced with the application settings. Any changes to device addresses or driver properties in RSLinx communication will be lost.
6. Press OK to return to the previous screen.
7. Press OK to return to Terminal Settings.

Run the Loaded Application on Startup

Follow these steps to run the loaded application on startup.

1. Select Terminal Settings>Startup Options>FactoryTalk View ME Station Startup.

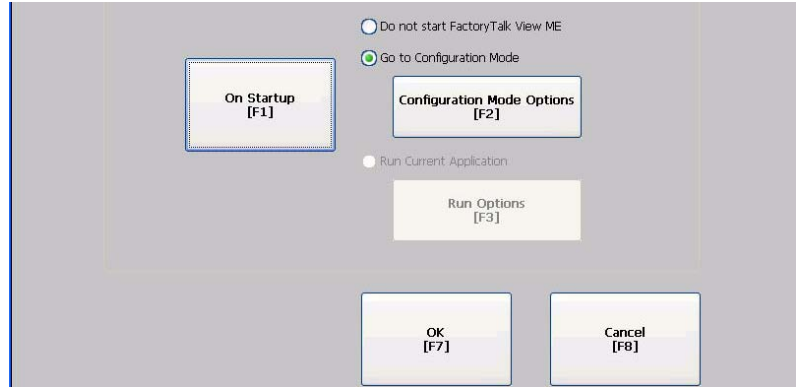

2. Press the On Startup button to select Run Current Application.

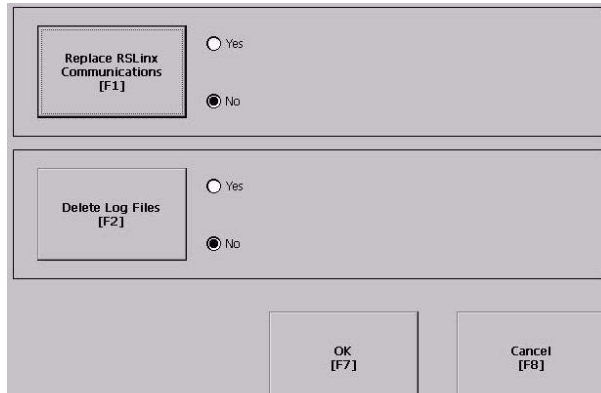

If an application is not loaded, the options are disabled.

3. Press the Replace RSLinx Communications button to specify what configuration settings to use when running the application.
 - Select No to use the RSLinx configuration of the terminal.
 - Select Yes to use the configuration of the application. The terminal configuration is replaced with the application settings. Any changes to device addresses or driver properties in RSLinx communication will be lost.
4. Press the Delete Log Files to specify what action to take with the log files on startup.
 - Select Yes to delete all log files (data, alarm history, alarm status) generated by the terminal before running application. The files are deleted from the system default location.
 - Select No to retain all log files.
5. Press OK twice to return to Terminal Settings.

Configuring Startup Tests

The terminal can run extended tests on startup. You can select which test to run and also specify test settings on startup.

Select Tests to Run on Startup

Follows these steps to select tests to run on startup.

1. Select Terminal Settings>Startup Options>Startup Tests.

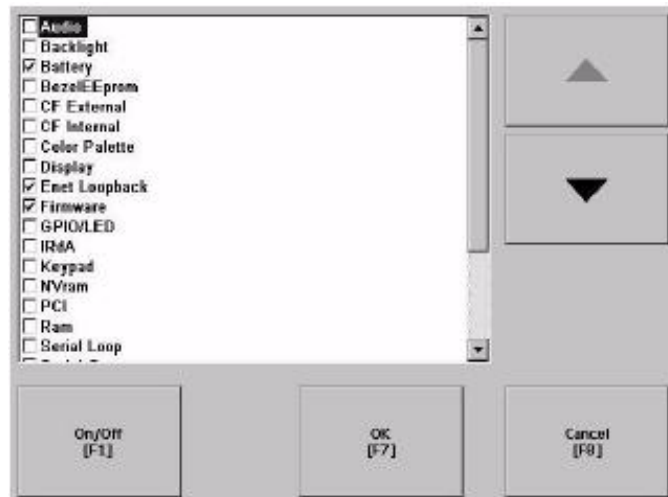

The screen shows a list of each test that can be performed on the terminal at startup and its current On/Off status. You can turn any test in the list on or off by selecting the On/Off button. The terminal will run tests only with a checked box.

2. Select the tests you want to run on startup.
 - Use the up and down cursor buttons to highlight a test.
 - Press the On/Off button to select a test. A checked box means the test is selected to run. Press the button again to clear the check box.
3. Press OK.

Configure Startup Test Settings

Follow these steps to specify how many times to run the selected tests on startup and to enable extended diagnostics.

IMPORTANT

Enabling extended diagnostics and setting a high repeat count will increase the time it takes the terminal to reboot.

The tests will run each time you reset or cycle power to the terminal until you disable extended diagnostics. Setting a low repeat count will also decrease the startup time.

1. Select Terminal Settings>Startup Options>Startup Test Settings.

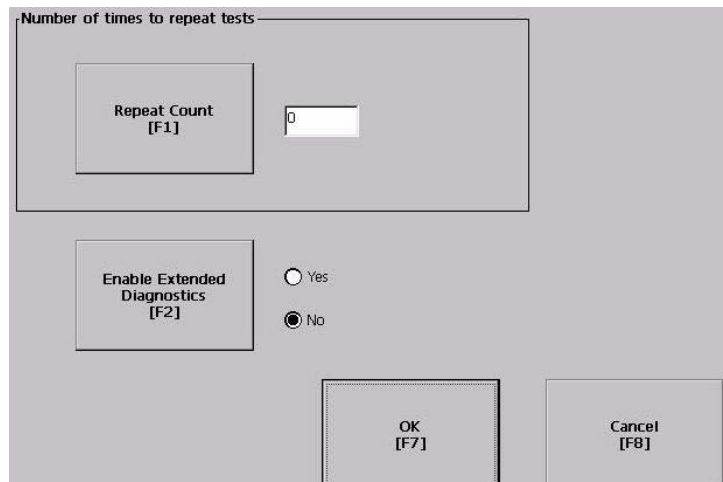

2. Press the Repeat Count button to specify the number of times, 0... 128, to run the selected tests on startup.
3. Press the Enable Extended Diagnostics button to enable or disable extended diagnostics on startup.
 - Select Yes to enable extended diagnostics.
 - Select No to disable extended diagnostics.
4. Press OK.

Clearing the System Event Log

The System Event Log screen displays a list of system events logged by the terminal.

Follow these steps to clear all or some of the events from the system event log.

1. Select Terminal Settings>System Event Log.

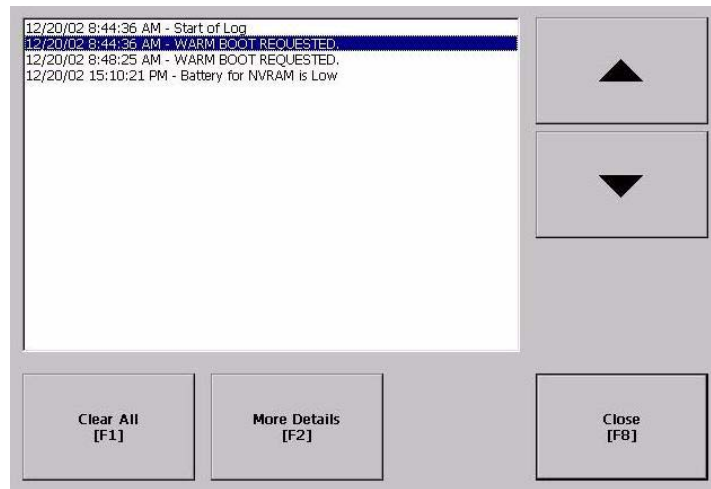

2. Select an event and then press the More Details button to display system event log details for that event.
3. Press the Clear All button to clear all system event logs.
4. Press OK.

Displaying Terminal Information

You can view these details for your terminal:

- Total power on time
- Processor temperature
- Battery voltage and battery state
- Amount of memory on terminal

Follow these steps to display terminal information.

1. Select Terminal Settings>System>Information>Terminal Information.

Total power on time (minutes): 34200	Battery voltage: 3.22
Processor temperature: 40.00 °C	Battery state: GOOD
Memory: 48144KB RAM	
Memory Allocation [F1]	Close [F8]

All fields are read-only except for memory allocation.

Battery State	400 and 600 Terminals	1000 Terminals
Good	Good battery condition.	Good battery condition.
Failing	Does not have a replaceable battery. Replace the terminal.	Low battery. Replace the battery.
Bad	Does not apply.	Battery is missing or bad. Replace the battery.

IMPORTANT

For the 400 and 600 terminals, the Battery Voltage indicates the battery state only and the Processor Temperature shows the temperature of the display.

2. Press the Memory Allocation button to view or adjust the:
 - amount of allocated storage or program memory.
 - amount of storage or program memory in use.

The screenshot displays a memory allocation interface with two columns: 'Storage memory' and 'Program memory'. Each column has an 'Up' button (F1 for storage, F3 for program) and a 'Down' button (F2 for storage, F4 for program). Below each button is a text field showing the current value. At the bottom are 'OK (F7)' and 'Cancel (F8)' buttons.

Memory Type	Control	Value
Storage memory	Up [F1]	24172 KB
	Down [F2]	688 KB
Program memory	Up [F3]	24116 KB
	Down [F4]	4972 KB

3. Press the Up or Down button to increase or decrease the allocation of storage or program memory.
Each button press changes the allocation by a value of four. If you change the allocation for one type of memory, the other is updated accordingly.

IMPORTANT

These settings are not retained after a power cycle. The settings return to the defaults.

4. Press OK to return to previous screen.
5. Press OK to return to terminal settings.

Displaying FactoryTalk View ME Station Information

You can display the firmware number of FactoryTalk View ME Station software and the Rockwell Automation technical support number.

1. Select Terminal Settings>System>Information>About FactoryTalk View ME Station.

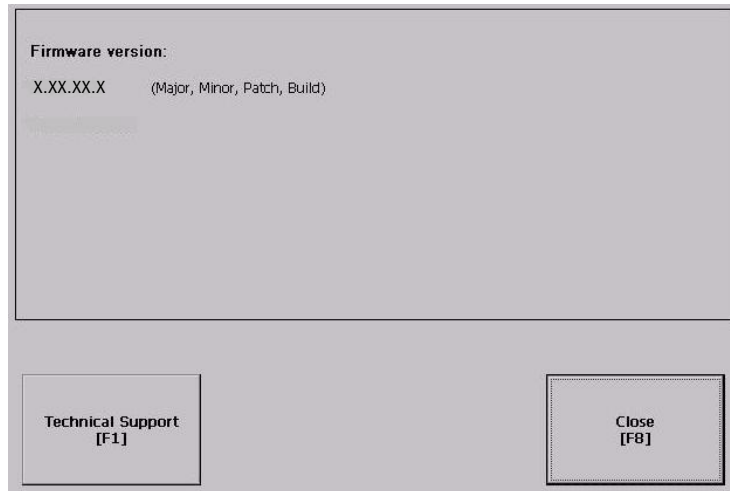

2. Press the Technical Support button, if desired.
3. Press Close.

Modifying the Date, Time, or Time Zone

You can adjust the date and time for terminal operations, or change the time zone.

Change the Date

Follow these steps to change the date on the terminal.

1. Select Terminal Settings>Time/Date/Regional Settings>Date.
The current date appears in the Year, Month, and Day fields.

2. Press the Year, Month, and Day buttons to change values.

Field	Description	Valid Values
Year	The current year in a four-digit format.	1980...2099
Month	The current month.	1...12
Day	The current day. The day of the month is validated based on the month.	0...31

3. Press OK when done.

Change the Time

Follow these steps to change the time on the terminal.

1. Select Terminal Settings>Time/Date/Regional Settings>Time.
The current time appears in 24-hour format in separate Hour, Minute, and Second fields.

2. Press the Hour, Minute, and Seconds buttons to change values.

Field	Description	Valid Values
Hour	The current hour in 24-hour format.	0...23
Minute	The current minute in 24-hour format.	0...59
Seconds	The current second in 24-hour format.	0...59

3. Press OK when done.

Change the Time Zone

You can modify the current time zone on the terminal. Time zones are installed as a part of the operating system. When changing the time zone, the current time and date are adjusted to match the time zone.

Follow these steps to change the time zone.

1. Select Terminal Settings>Time/Date/Regional Settings>Time Zone.

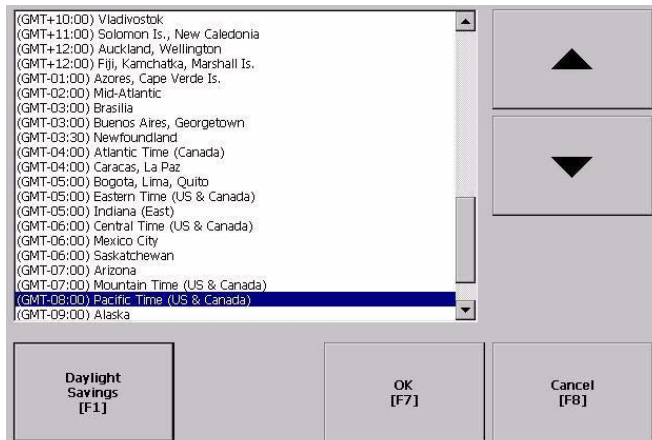

2. Press the up and down cursor buttons to select a time zone.

Language	Default Time Zone
English	(GMT -05:00) Eastern Time (US and Canada)
French	(GMT +01:00) Brussels, Copenhagen, Madrid, Paris
German	(GMT +01:00) Amsterdam, Berlin, Bern, Rome, Stockholm, Vienna
Japanese	(GMT +09:00) Osaka, Sapporo, Tokyo

If the selected time zone supports Daylight Savings, the Daylight Savings button is available.

3. Press the Daylight Savings button to enable or disable daylight savings for the selected time zone.

Daylight Savings is set to Yes for all time zones except Japanese, which does not support daylight savings. Changes are permanently applied when you close the Time Zone screen.

4. Press the Use Daylight Savings Button to select Yes or No.

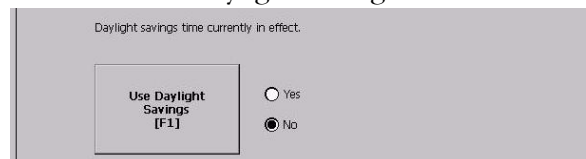

5. Click OK when done.
6. Click OK to return to Terminal Settings.

Modifying Regional Settings

You can adjust regional settings for a specific language installed on the terminal, including the date, time and numeric formats.

To access regional settings for a language, select Terminal Settings>Time/Date/Regional Settings>Regional Settings. The current language appears at the bottom of the Regional Settings screen.

Select a Language

You can select a language that is installed on the terminal. Languages are installed as a part of the operating system.

1. Select Terminal Settings>Time/Date/Regional Settings>Regional Settings>Language.

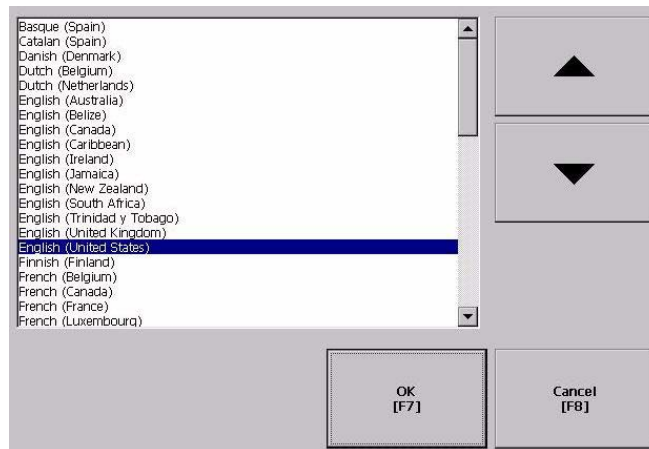

2. Select a language by pressing the up and down cursor keys.
3. Press OK.

The selected language appears at the bottom of the Regional Settings screen.

Change the Decimal Separator for Numeric Formats

You can change the decimal separator used in numerics for the current language. The default decimal separator is a period.

1. Select Terminal Settings>Time/Date/Regional Settings>Regional Settings>Numeric Format.



The field shows the default decimal separator. The field accepts three characters.

2. Enter up to three characters for the new separator.
3. Click OK.

Change the Time Format

You can change the time format for the selected language.

1. Select Terminal Settings>Time/Date/Regional Settings>Regional Settings>Time Format.

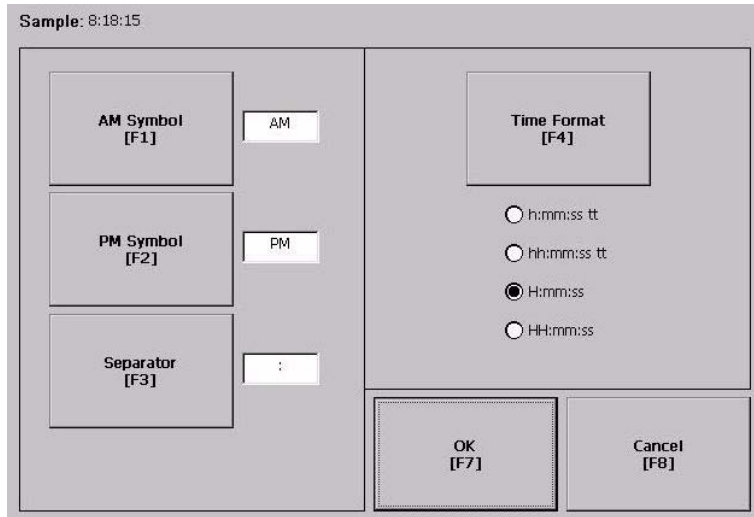

The current time is shown in the currently selected format.

2. Press the appropriate buttons to adjust the formats.

Field	Description	Example
Time Format	h:mm:ss tt (default) h = hour, no leading zero tt = AM or PM symbol	7:23:02 AM or 1:13:31 PM 11:43:59 AM
	hh:mm:ss tt hh = hour with leading zero tt = AM or PM symbol	07:23:02 AM or 01:13:31 PM 11:43:59 PM
	H:mm:ss H = hour in 24-hour format, no leading zero	7:03:42 or 1:13:32 23:43:59
	HH:mm:ss HH = hour in 24-hour format with leading zero	07:03:42 or 01:13:22 23:43:59
AM Symbol	Characters to indicate AM. If the time format is set to h:mm:ss tt or hh:mm:ss tt, you can modify the AM symbol.	AM (default) 12 character max
PM Symbol	Characters to indicate PM. If the time format is set to h:mm:ss tt or hh:mm:ss tt, you can modify the PM symbol.	PM (default) 12 character max
Separator	Characters that separate fields in time format.	: (default) 3 character max

3. Click OK.

Change the Short Date Format

You can change the short date format for the selected language.

1. Select Terminal Settings>Time/Date/Regional Settings>Regional Settings>Short Date Format.

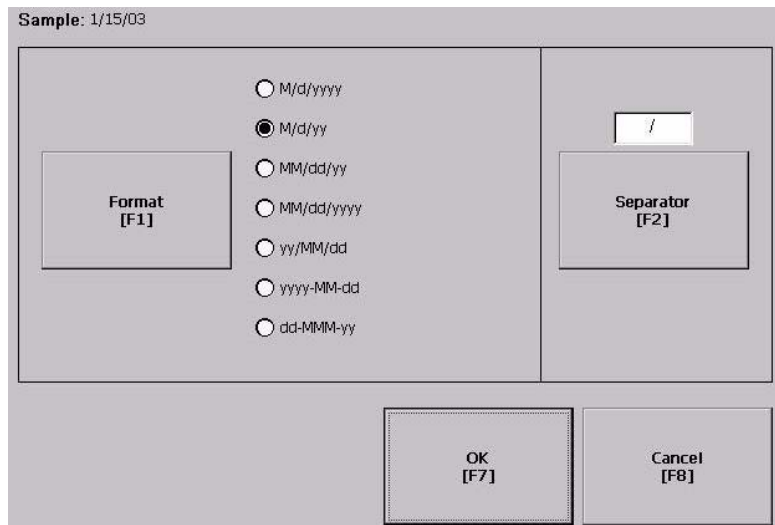

The current date is shown in the selected, short date format.

Field	Short Date Formats	Example
Format	M/d/yyyy (default) M/d/yy MM/dd/yy MM/dd/yyyy yy/MM/dd yyyy-MM-dd dd-MMM-yy	1/2/2003 1/2/03 01/02/03 01/02/2003 03/01/02 2003-01-02 02-Jan-03
Separator	Character separator for fields in time format. The default separator is either - or / depending on short date format.	- or / (default) 3 character max

2. Press the Format button to select an available format.
3. Press the Separator button to change the field separator for the date elements.
4. Click OK when done.

Change the Long Date Format

You can change the long date format used by the selected language.

1. Select Terminal Settings>Time/Date/Regional Settings>Regional Settings>Long Date Format.

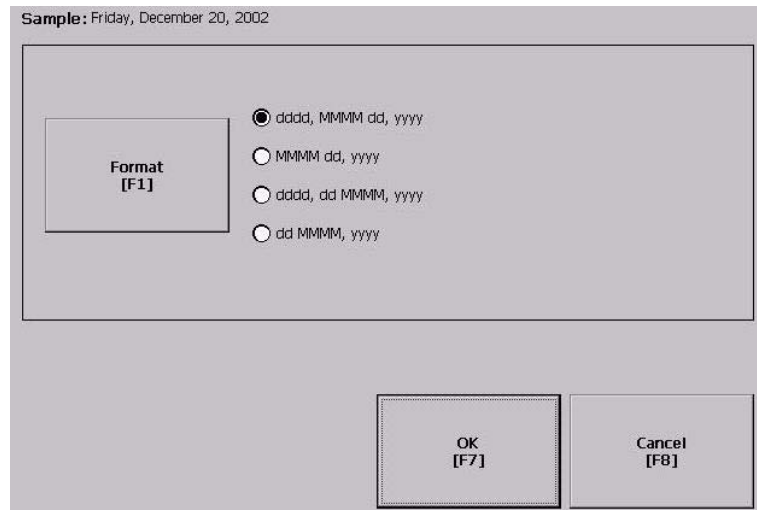

The current date is shown in the selected long date format.

2. Press the Long Date Format button to select a date format.

Long Date Formats	Example
dddd, MMMM, dd, yyyy (default) dddd is name of week day MMMM is name of month dd is two-digit day of month with leading zero yyyy is four-digit year	Monday, January 01, 2003
MMMM dd, yyyy MMMM is name of month dd is two-digit day of month with leading zero yyyy is four-digit year	January 01, 2003
dddd, dd MMMM, yyyy dddd is name of week day dd is two-digit day of month with leading zero MMMM is name of month yyyy is four-digit year	Monday, 01 January, 2003
dd MMMM, yyyy dd is two-digit day of month with leading zero MMMM is name of month yyyy is four-digit year	01 January, 2003

3. Click OK when done.

Installing and Replacing Components

Chapter Objectives

This chapter shows how to install or replace specific components of the terminals.

- Battery
- Backlight
- External CompactFlash card
- Product ID label
- Display module bezel

Required Tools

These tools are required to install and replace components:

- #00, #1, and #2 Phillips screwdriver
- Electrostatic Discharge (ESD) wristband

Precautions

Before installing or replacing any components, disconnect power from the terminal. During installation, take care not to touch any of the exposed electronic components.

WARNING

Disconnect all power from the terminal before installing or replacing any components. Failure to disconnect power may result in electrical shock or damage to the terminal.

ATTENTION

Be careful when touching any of the exposed electronic components to prevent damage from electrostatic discharge (ESD).

Work in a static free environment and wear a properly grounded ESD wristband.

Replacing the Battery

The lithium battery in the terminals is used by the real-time clock and static RAM; it is not used for application backup or retention. The clock module has a life expectancy of two years without power.

The replacement battery is catalog number 2711P-RY2032.

WARNING



When you connect or disconnect the battery an electrical arc can occur. This could cause an explosion in hazardous location installations. Be sure that power is removed or the area is nonhazardous before proceeding. Replace the battery only with the indicated catalog number.

For safety information on the handling of lithium batteries, including handling and disposal of leaking batteries, see Guidelines for Handling Lithium Batteries, publication [AG 5-4](#).

Battery Replacement for the 1000 Terminals



This product contains a hermetically sealed lithium battery which may need to be replaced during the life of the product.

At the end of its life, the battery contained in this product should be collected separately from any unsorted municipal waste.

The collection and recycling of batteries helps protect the environment and contributes to the conservation of natural resources as valuable materials are recovered.

Follow these steps to replace the battery in the 1000 terminal.

1. Disconnect power from the terminal.
2. Place the terminal, display side down, on a flat stable surface.
3. Loosen the six captive screws that attach the logic module to the display module.

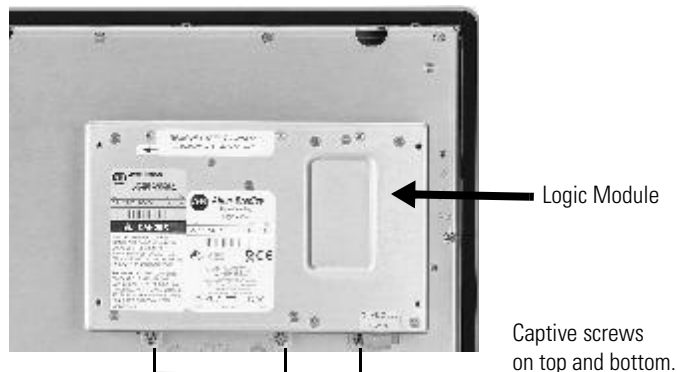

- Carefully lift the logic module away from the terminal and flip over to expose the circuit board.

ATTENTION

Wear a properly grounded ESD wristband before touching any of the electronic components in the logic module.

- Locate the battery on the circuit board.

Remove battery by lifting up the edge indicated by arrow.

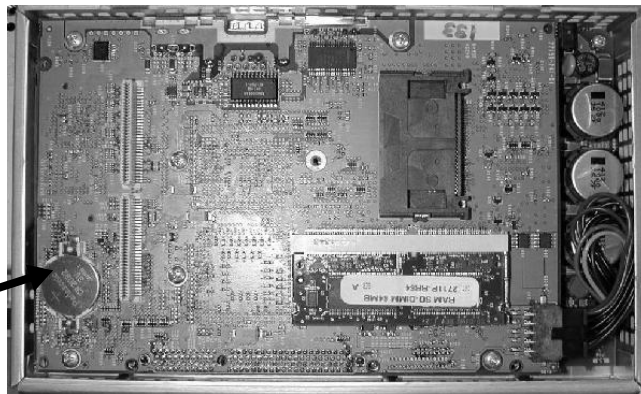

- Remove the battery by lifting up the side of the battery.
- Insert the new battery.

IMPORTANT

Use only catalog number 2711P-RY2032 to replace the battery.

- Attach the logic module by aligning the two connectors on the bottom of the module with the connectors on the terminal.



- Push down on the logic module until firmly seated.
- Tighten the six captive screws that secure the logic module to a torque of 0.58 N•m (5...7 lb•in).

Battery Removal for the 400 and 600 Terminals

The lithium battery in the 400 and 600 is non-replaceable and should be removed only at the end of product life.



This product contains a hermetically sealed lithium battery which is permanently connected and should be removed only by trained professionals.

At the end of its life, the battery contained in this product should be collected separately from any unsorted municipal waste.

The collection and recycling of batteries helps protect the environment and contributes to the conservation of natural resources as valuable materials are recovered.

Follow these steps to remove the battery in the 400 and 600 terminals.

1. Disconnect power from the terminal.
2. Place the terminal, display side down, on a flat stable surface.
3. Unlatch the eight retaining tabs (two on each side) on the back cover and remove cover.
4. Locate the yellow battery on the logic board.
5. Remove the battery.

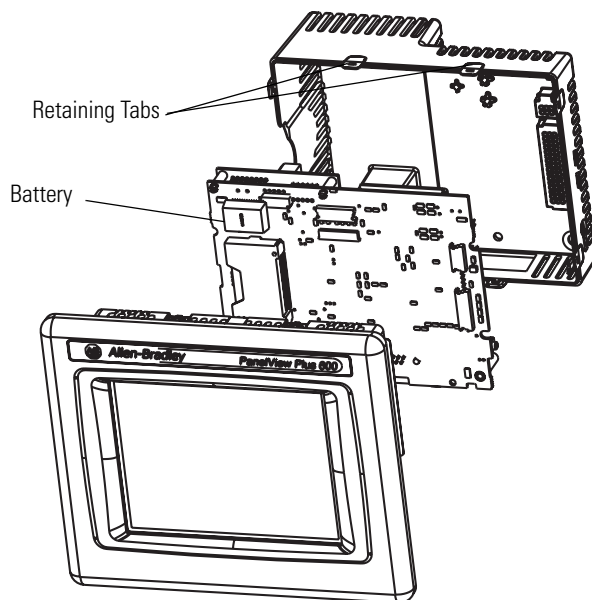

Replacing the Backlight

This section shows how to replace the backlight in the 1000 terminal. The replacement backlight is catalog number 2711P-RL10C2.

IMPORTANT

The backlight contains mercury. At the end of its life, the backlight should be collected separately from unsorted municipal waste.

Follow these steps to replace the backlight.

1. Disconnect power from the terminal.
2. Remove the display module bezel.
3. Remove the four screws that secure the LCD display.

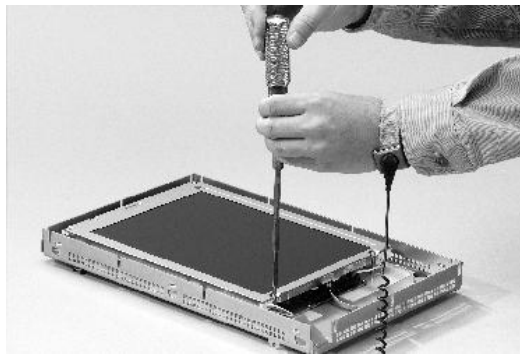

4. Lift the LCD display and detach the display connector from the circuit board.

The circuit board layout may vary for each terminal model.

The location of the connector varies by model.

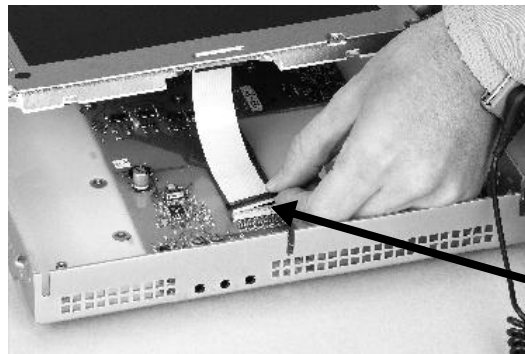

5. Detach the backlight connector from the circuit board.

6. Press the retaining tab that secures the backlight and then pull out the backlight.

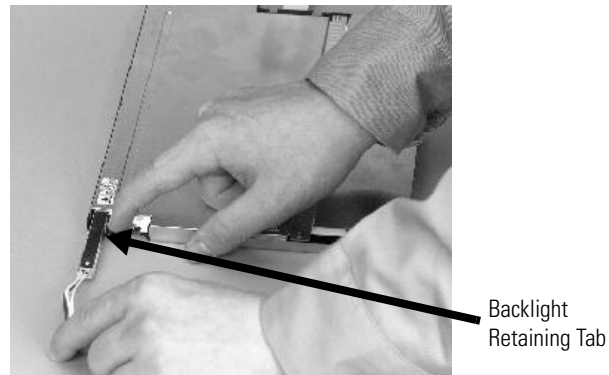

7. Insert the new backlight.

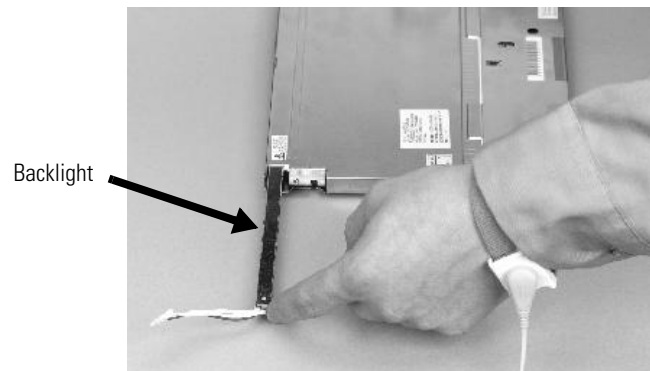

8. Attach the LCD display connector to the circuit board.
Refer to step 4.
9. Attach the backlight connector to the circuit board.
Refer to step 5.
10. Secure the LCD display with the four screws and tighten the screws to a torque of 0.58 N•m (5...7 lb•in).
11. Replace the display module bezel.

Using an External CompactFlash Card

All of the terminals have a CompactFlash card slot that supports Type 1 CompactFlash cards. These cards are available in different memory sizes.

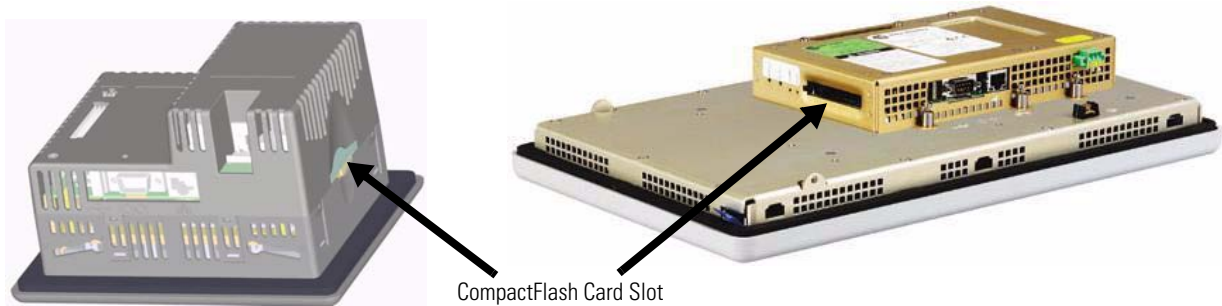

Insert a CompactFlash Card

Insert the card in the CompactFlash card slot of the terminal until firmly seated.

400 and 600 Terminals



1000 Terminals

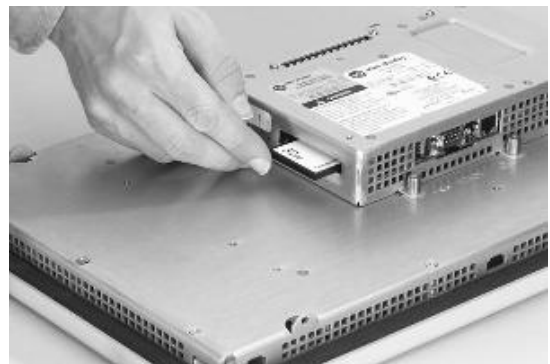

Remove a CompactFlash Card

Press the Eject button on the logic module. When the button pops out, press it again to release the card. The location of the button varies depending on the series of the logic module.

The 400 and 600 terminals do not have an eject button. Simply secure edge of card with fingers and pull card away from slot.



Removing the Product ID Label

You can replace the label on the terminal with another label.

1. Remove the Allen-Bradley label using your fingers or a tweezers.

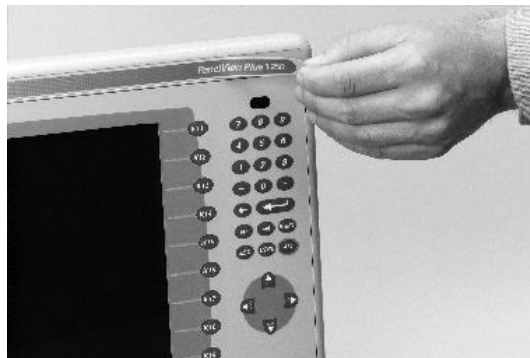

2. Clean area with damp cloth and isopropyl alcohol.
3. Remove adhesive backing of OEM label and affix over area where label was located.

Replacing the Bezel

The 1000 terminal has a touch screen that can only be replaced with the same touch screen. You do not have to remove the logic module before removing the display module bezel.

Follow these steps to remove the display module bezel on the 1000 terminal.

1. Disconnect power from the terminal.
2. Set the terminal, display side down, on a flat stable surface.

ATTENTION



Wear a properly grounded ESD wristband before touching any of the electronic components in the logic module.

3. On touch-screen-only terminals, remove the two screws that secure the small metal plate to the back of the display module.
4. Disconnect the touch screen connector.

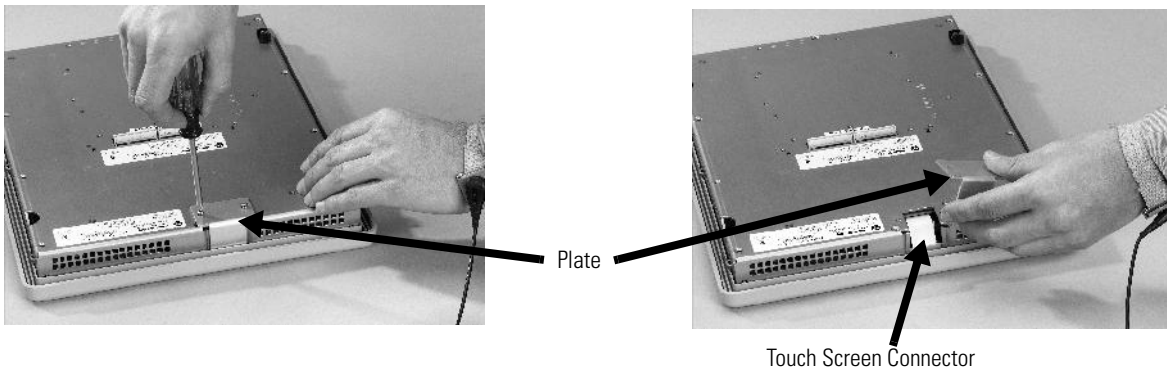

5. Remove the screws from the back of the display module. The number of screws varies for each terminal type.

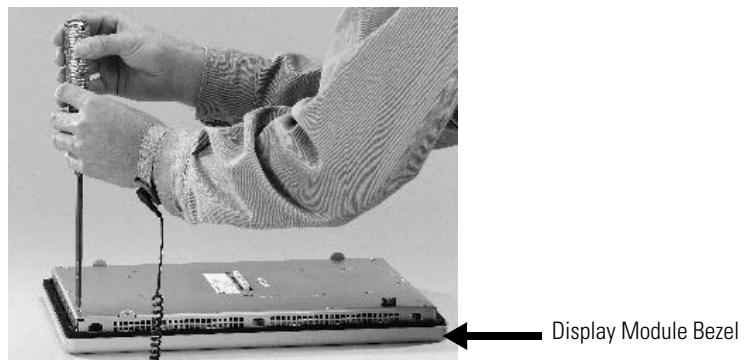

6. Remove the sealing gasket.

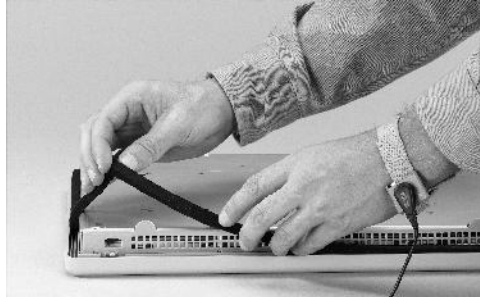

7. Lift the back of the display module away from the bezel.
Work on a clean, flat, stable surface to protect the display from debris, scratches and damage.

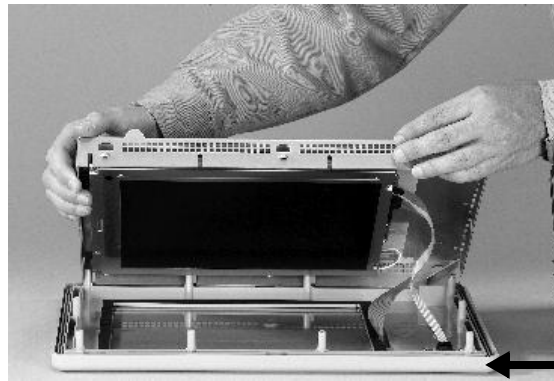

Display Module Bezel

8. Detach the touch screen connector.
9. Set the bezel aside.

Follow these steps to replace the display module bezel.

1. Make sure the bezel is free of lint and marks.
2. Attach the touch screen connector.
3. Place the back of the display module over the bezel.
Be careful not to pinch any of the cables. Allow the touch screen connector to extend out of the access opening.
4. Connect the touch screen connector.
5. Replace the sealing gasket.
6. Attach the screws that secure the display module to the bezel and tighten to a torque of 1.35...1.58 N•m (12...14 lb•in).
7. Re-attach the small metal plate to the back of the display module using two screws and torque to 0.58 N•m (5...7 lb•in).

Cleaning the Display Window

Use a protective antiglare overlay for easier cleaning of the display window.

ATTENTION

Use of abrasive cleaners or solvents may damage the display. Do not scrub or use brushes.

Follow these steps to clean the display window.

1. Disconnect power from the terminal at the power source.
2. Use a clean sponge or soft cloth with a mild soap or detergent to clean the display.
3. Dry the display with a chamois or moist cellulose sponge to avoid water spots.

Remove fresh paint splashes and grease before drying by rubbing lightly with isopropyl alcohol (70% concentration). Afterward, wash using a mild soap or detergent. Rinse with clean water.

Terminal Connections

Chapter Objectives

This chapter provides network and device connections for the terminals.

- Runtime communication cables
- Communication port isolation
- USB ports
- Serial connections on base unit
- Ethernet (onboard communication)

Cables for Runtime Communication

The tables provide a summary of terminal connections to controllers and network interface modules for runtime communication.

PanelView Plus Compact Terminals to SLC Controllers

Cables: PanelView Plus Compact Terminals to SLC Controllers						
Protocol	PanelView Plus Compact 400, 600, 1000 Comm Port	SLC-500, 5/01, 5/02 CH1 RJ45 (DH-485)	SLC-5/03, 5/04, 5/05 CH0 (9-pin RS-232) (DF1 or DH-485)	SLC 5/03 CH1 (RJ45) (DH-485)	SLC 5/04 CH1 (DH+)	SLC 5/05 CH1 (ENET)
DF1	RS-232 (DF1) Comm port (9-pin)	N/A	2711-NC13 (5 m/16 ft) 2711-NC14 (10 m/32 ft) 2706-NC13 (3 m/10 ft)	N/A	N/A	N/A
DH-485	RS-232 (DH-485) Comm port (9-pin)	Use AIC+ module (1761-NET-AIC) Connect to port 1 or 2	2711-NC13 (5 m/16 ft) 2711-NC14 (10 m/32 ft) 2706-NC13 (3 m/10 ft)	Use AIC+ module (1761-NET-AIC) Connect to port 1 or 2	N/A	N/A
EtherNet/IP	EtherNet/IP Comm port	N/A	Use 1761-NET-ENI module with Ethernet cable	N/A	N/A	2711P-CBL-EX04 Ethernet crossover cable ⁽¹⁾

⁽¹⁾ An EtherNet/IP direction connection between a PanelView Plus Compact terminal and an SLC 5/05 requires hub or crossover cable listed.

PanelView Plus Compact Terminals to MicroLogix Controllers

Cables: PanelView Plus Compact to MicroLogix Controllers				
Protocol	PanelView Plus Compact 400, 600, 1000 Comm Port	MicroLogix 1500LRP CH1 (9-pin RS-232) (DF1 or DH-485)	MicroLogix 1000, 1200, 1500LSP CH0 (8-pin Mini DIN) (DF1 or DH-485)	MicroLogix 1100, 1400 Ethernet Port
DF1	RS-232 (DF1) Comm port (9-pin)	2711-NC13 (5 m/16 ft) 2711-NC14 (10 m/32 ft) 2706-NC13 (3 m/10 ft)	2711-NC21 (5 m/16 ft) 2711-NC22 (15 m/49 ft) (null modem not required) ⁽¹⁾	N/A
DH-485	RS-232 (DH-485) Comm port (9-pin)	2711-NC13 (5 m/16 ft) 2711-NC14 (10 m/32 ft) 2706-NC13 (3 m/10 ft)	2711-NC21 (5 m/16 ft) 2711-NC22 (15 m/49 ft) (null modem not required) ⁽¹⁾	N/A
EtherNet/IP	EtherNet/IP Comm port	Use 1761-NET-ENI module with Ethernet cable		Ethernet cable

⁽¹⁾ AIC+ Module recommended for isolation when PanelView and controller are not using same power supply.

PanelView Plus Compact to Logix Controllers

		Cables: PanelView Plus Compact to Logix Controllers	
Protocol	PanelView Plus Compact 400, 600, 1000 Comm Port	ControlLogix CH0 (9-pin RS-232) (DF1)	CompactLogix CH0 (9-pin RS-232) (DF1 or DH-485)
DF1	RS-232 (DF1) Comm port (9-pin)	2711-NC13 (5 m/16 ft) 2711-NC14 (10 m/32 ft) 2706-NC13 (3 m/10 ft)	
DH-485	RS-232 (DH-485) Comm port (9-pin)	N/A	2711-NC13 (5 m/16 ft) 2711-NC14 (10 m/32 ft) 2706-NC13 (3 m/10 ft)
EtherNet/IP	EtherNet/IP Comm port	Use 1756-ENET or 1756-ENBT module with Ethernet cable	To 1769-L35E with Ethernet cable

PanelView Plus Compact to Logix Communication Adapters

		Cables: PanelView Plus Compact to Communication Adapters		
Protocol	PanelView Plus Compact 400, 600, 1000 Comm Port	1761-NET-AIC		
		Port 1 (9-pin)	Port 2 8-pin Mini DIN	Port 3 (DH-485)
DF1	RS-232 Comm port (9-pin)	2711-NC13 (5 m/16 ft) 2711-NC14 (10 m/32 ft) 2706-NC13 (3 m/10 ft)	2711-NC21 (5 m/16 ft) 2711-NC22 (15 m/49 ft)	N/A
DH-485	RS-232 Comm port (9-pin)	2711-NC13 (5 m/16 ft) 2711-NC14 (10 m/32 ft) 2706-NC13 (3 m/10 ft)	2711-NC21 (5 m/16 ft) 2711-NC22 (15 m/49 ft)	N/A

Communication Port Isolation

The table summarizes electrical isolation for the communication ports on the PanelView Plus Compact terminals.

Communication Port	400 and 600 Terminal	1000 Terminal
RS-232	Nonisolated	Isolated
USB	Nonisolated	Nonisolated
Ethernet	Isolated	Isolated

USB Ports

The 1000 terminals have two USB ports. The 400 and 600 terminals have one USB port. The terminals support standard USB keyboard and mouse devices (HID devices) with native device drivers. They also support some USB printers that have Printer Control Language (PCL) capabilities. A vendor specific Windows CE driver is required for all other USB devices.

See [Appendix B](#) for a list of compatible USB devices.

Plug the USB device into either one of the two USB ports on the 1000 terminals.

400 and 600 USB Port

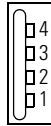

1000 USB Ports

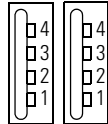

USB Connector Pinout

Pin	Signal
1	USBVCC
2	USBD-
3	USBD+
4	USB-GND

WARNING



Do not connect or disconnect the communication cable with power applied to the terminal, or the serial device on the other end of the cable. An electrical arc could cause an explosion in hazardous location installations. Be sure that power is removed or the area is nonhazardous before proceeding.

WARNING



USB devices not powered by the USB port must be within the same enclosure and connected to a ground system common with the terminal, or the USB devices must be used with a USB hub that provides galvanic isolation.

If a USB hub is connected to the terminal, an externally powered USB hub is recommended. Before attaching devices to a USB hub, check that the power adapter is connected and powered on.

Serial Connections

All compact terminals have a serial RS-232 port that supports:

- DH-485 communication through a serial connection.
- DF1 full duplex communication with controllers using direct connections or modem connections.
- third-party point-to-point communication.
- application uploads/downloads.
- printing.

The serial port on the terminals is a 9-pin, male, RS-232 connector. The table shows the pinout descriptions for this port and how these pins map to the serial ports on the controllers.

PanelView Plus Compact 400 and 600 Terminals

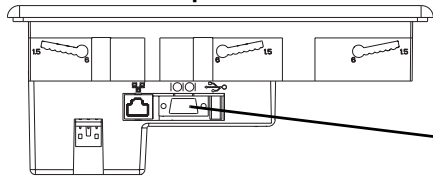

PanelView Plus Compact 1000 Terminal

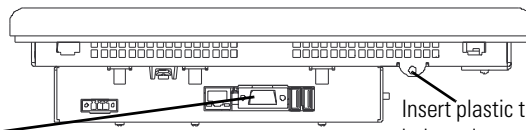

Serial RS-232 Port

Serial RS-232 Port

Insert plastic tie wrap in the hole and use as strain relief for all attached cables.

Serial Port Connector Pinout

PanelView RS-232 Port 9-pin DCE		SLC 9-pin	PLC 25-pin	MicroLogix/ DNI 8-pin DIN
1				
2	RXD →	2	3	4
3	← TXD	3	2	7
4	← DTR	4	20	
5	← COM →	5	7	2
6	→ DSR	6	6	
7	← RTS	7	4	
8	→ CTS	8	5	
9				
Connector Shell	Chassis Gnd			

The maximum cable length for serial communication is 15.24 m (50 ft).

WARNING



Do not connect or disconnect the communication cable with power applied to the terminal, or the serial device on the other end of the cable. An electrical arc could cause an explosion in hazardous location installations. Be sure that power is removed or the area is nonhazardous before proceeding.

Modem Connection

Wire or radio modem communication is possible between the terminal and controller. Each modem must support full duplex communication. Refer to your modem user manual for details on settings and configuration.

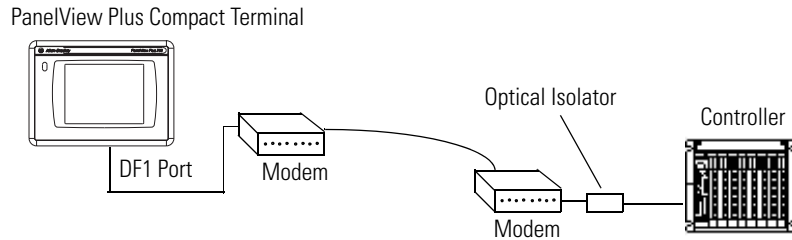

Construct a Null Modem Cable

To construct a null modem cable, refer to this pinout.

Null Modem Pinout

	PanelView 9-pin	9-pin Modem	PanelView 9-pin	25-pin Modem	
FG (Frame Ground)	-	-	-	1	FG
TD (Transmit Data)	3	2	3	3	RD
RD (Receive Data)	2	3	2	2	TD
RTS (Request to Send)	7	8	7	5	CTS
CTS (Clear to Send)	8	7	8	4	RTS
SG (Signal Ground)	5	5	5	7	SG
DSR (Data Set Ready)	6	4	6	20	DTR
DTR (Data Terminal Ready)	4	6	4	6	DSR

Computer Connections

The RS-232 serial port on the base-configured unit of the terminals supports:

- application uploads/downloads using a direct connection.
- printing.

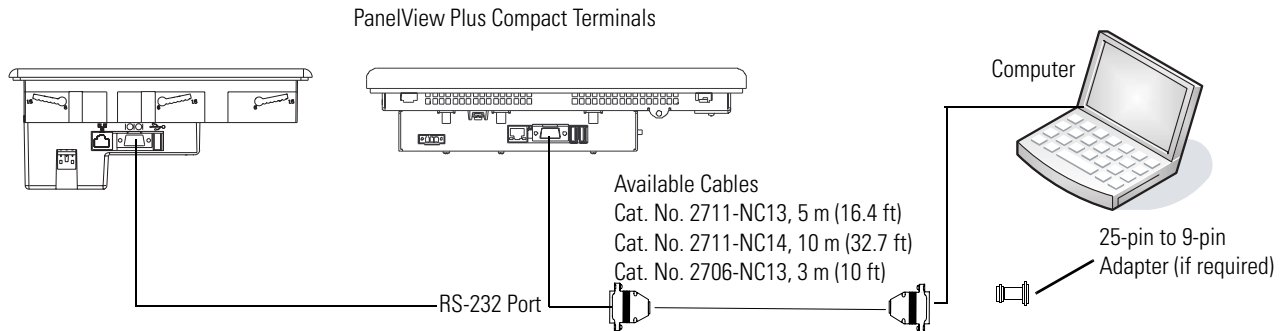

PanelView Port (DCE)		Computer Port (DTE) with Handshaking
9-pin male		9-pin male
1 NC		1 DCD
2	→ RXD	2 RXD (Data Receive)
3	← TXD	3 TXD (Data Transmit)
4 NC		4
5	← COM	5 COM
6 (pulled high to +12V)	→ DSR	6 DSR
7	← RTS	7 RTS
8	→ CTS	8 CTS
9 NC		9 NC

Upload/Download Cable without Hardware Handshaking

PanelView Printer Port (DCE)		Computer Port (DTE)	
9-pin male		9-pin	25-pin
2	→ RXD	2	3
3	← TXD	3	2
5	← COM	5	7

Ethernet Connections

The Ethernet port on the PanelView terminals supports:

- EtherNet/IP communication.
- third-party Ethernet communication.
- network connections.
- application uploads/downloads.
- printing.

Ethernet Connector

The terminals have an RJ45, 10/100 Base-T connector for EtherNet/IP or Ethernet TCP/IP network communication.

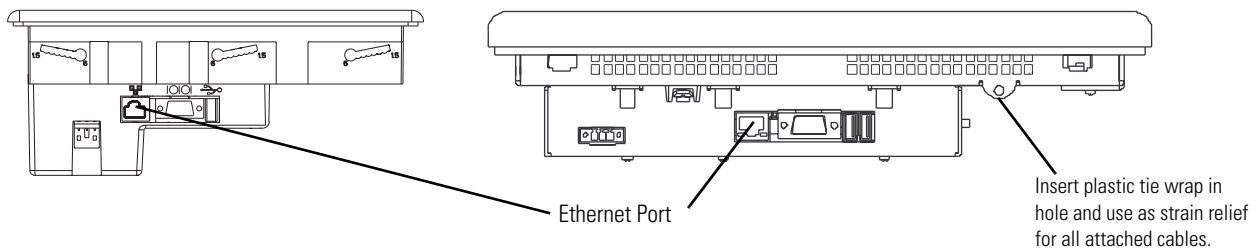

The table shows the connector pinouts.

Ethernet Connector Pinout

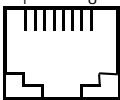
Pin	Pin	Pin Name
Looking into RJ45 Connector 	1	TD+
	2	TD-
	3	RD+
	4	NC
	5	NC
	6	RD-
	7	NC
	8	NC
	Shield Connection	No Direct Connection (AC coupled to Chassis GND)

Use point-to-point, 10/100 Base-T cables with cross over pin-outs, such as catalog number 2711P-CBL-EX04, when connecting the Ethernet port on the terminal directly to:

- Ethernet port on the controller.
- 10/100 Base-T port on a computer without a switch.

Ethernet Cable

For PanelView Plus Compact 1000 terminals use Belden 7921A shielded Ethernet Category 5e cable according to TIA 568-B.1 and RJ45 connector according to IEC 60603-7 for compliance with the European Union 89/336/EEC EMC Directive.

The maximum cable length between the terminal's Ethernet port and a 10/100 Base-T port on an Ethernet hub (without repeaters or fiber) is 100 m (328 ft).

WARNING

Do not connect or disconnect any communication cable with power applied to this device or any device on the network. An electrical arc could cause an explosion in hazardous location installations. Be sure that power is removed or the area is nonhazardous before proceeding.

Security Considerations

IGMP (Internet Group Management Protocol) is used for IPv4 multicast. A multicast is communication between a single sender and multiple receivers on a network. IGMP is used to exchange membership status data between IPv4 routers that support multicasting and members of multicast groups. A router is an intermediary device on a communication network that expedites message delivery by finding the most efficient route for a message packet within a network, or by routing packets from one subnetwork to another. A sub-network is a separate part of an organization's network identified through IP addressing.

PanelView Plus terminals provide level 2 (full) support for IPv4 multicasting (IGMP version 2) as described in RFC 1112 and RFC 2236.

SNMP (Simple Network Management Protocol) is used for internal network management and is not supported.

Ports 137 and 138 are normally open to support the NetBIOS protocol used by Windows CE.NET similar to other Microsoft and IBM network operating systems.

Upgrading Firmware

Chapter Objectives

This chapter shows how to upgrade firmware in a PanelView Plus Compact terminal using the Firmware Upgrade Wizard.

Transferring Applications

You can transfer applications using a CompactFlash card or a computer.

- To copy or load applications on the terminal from terminal configuration mode using a CompactFlash card, refer to [Loading an Application](#) on page 35.
- To transfer .MER applications from a computer to the terminals, refer to FactoryTalk View Studio help or documentation.

Firmware Upgrade Wizard

The Firmware Upgrade Wizard (FUW) provides two options for upgrading firmware in a PanelView Plus Compact terminal.

- Create a firmware upgrade card that you can then load in the CompactFlash card slot of the terminal to upgrade firmware.
- Upgrade firmware in a terminal connected to a computer over a direct serial or network connection. The network connection requires a computer running RSLinx Enterprise software.

Preparing Terminal for Upgrade

Before starting the FUW, you need to prepare the terminal for a successful upgrade.

1. Back up all .MER files on the terminal to an external storage card or network.
2. Delete all applications on the terminal.
3. Record Ethernet communication settings, such as IP address, subnet masks, and gateways by selecting Terminal Settings>Networks and Communications>Network Connections>Network Adapters>IP Address.
4. Disable the Autostart feature on the terminal by selecting Terminal Settings>Startup Options>FactoryTalk View ME Station Startup and select Go to Configuration Mode.
5. Reset the terminal.

Upgrading Firmware with a CompactFlash Card

Upgrading terminal firmware using a CompactFlash card is a two-step process. First, you create a firmware upgrade card with the necessary firmware files. Second, you load the card in the target terminal to upgrade the firmware.

Create a Firmware Upgrade Card

Follow these steps to create a firmware upgrade card.

1. Launch the Firmware Upgrade Wizard.
 - Select Start>Programs>Rockwell Software>FactoryTalk View>Tools>ME Firmware Upgrade Wizard.
 - Select Tools>Firmware Upgrade Wizard in FactoryTalk View Studio software.

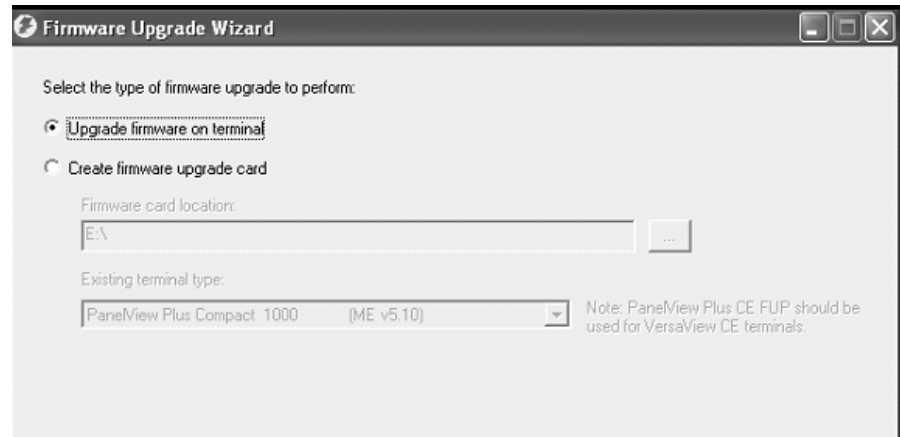

2. Select Create firmware upgrade card.
 - In the Firmware card location box, select the destination for the CompactFlash files, the physical location of the CompactFlash card, for example, E:\ or a folder on the hard drive.
 - From the Existing terminal type pull-down list, select the type of terminal you want to upgrade, then press Next.

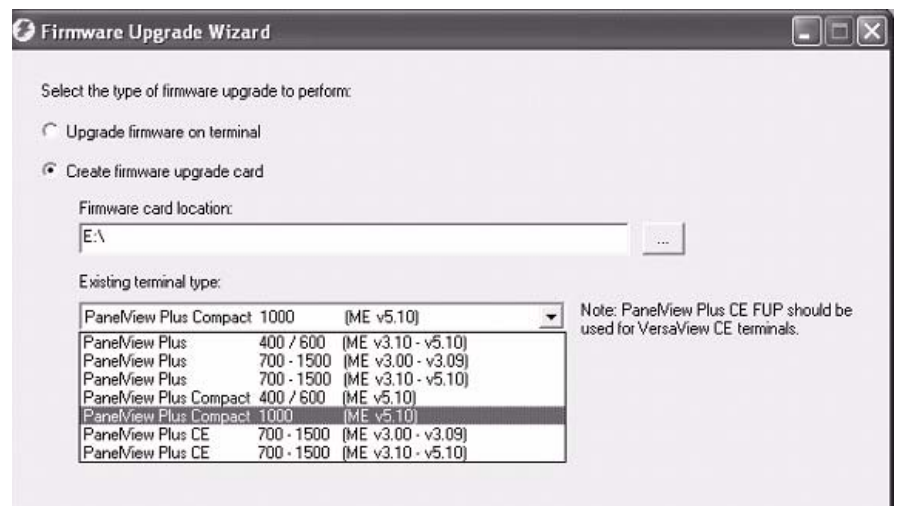

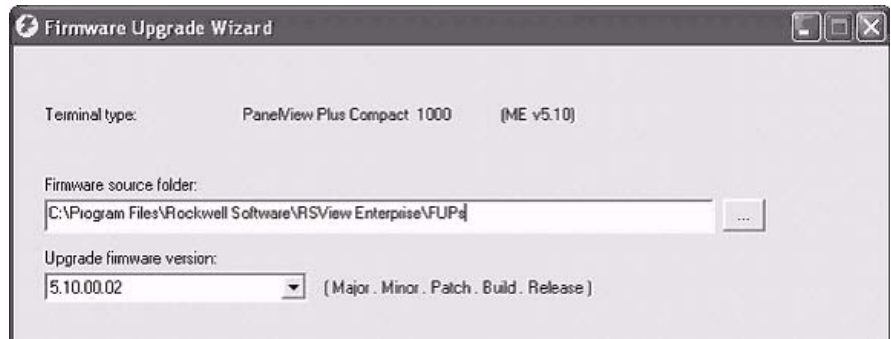

3. From the Firmware source folder list, browse to the location of the firmware files.
The default location is shown.
4. From the Upgrade firmware version list, select the firmware version for the upgrade, then press Next.

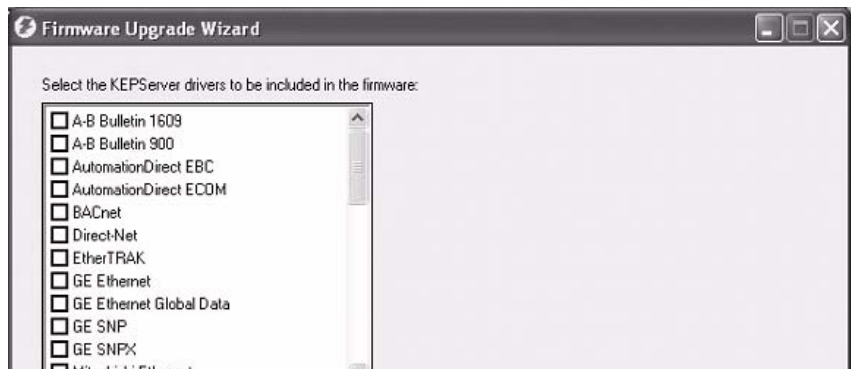

5. Select the appropriate KEPServer drivers, then click Next.
If no KEPServer drivers are needed, just click Next.

A dialog box shows the target terminal type, upgrade firmware version, and KEPServer drivers that the CompactFlash card firmware will set.

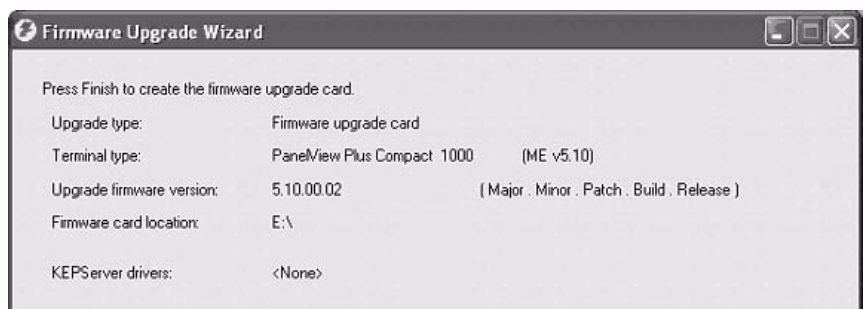

- Click Finish to copy the firmware source files to the location specified in step 2.

TIP If the files were created in a folder on a local hard drive, copy the files to the root directory of the CompactFlash card.

Upgrade Firmware in Terminal with Firmware Upgrade Card

Follow these steps to upgrade the terminal firmware from a CompactFlash card.

- Insert the CompactFlash card into the card slot of a powered terminal.

A dialog box indicates the firmware upgrade is about to occur.



- Press Upgrade to begin the firmware upgrade.

IMPORTANT Do not remove the CompactFlash card while the upgrade is in process.

A dialog box reminds you to back up all .mer and user files before upgrading the terminal.

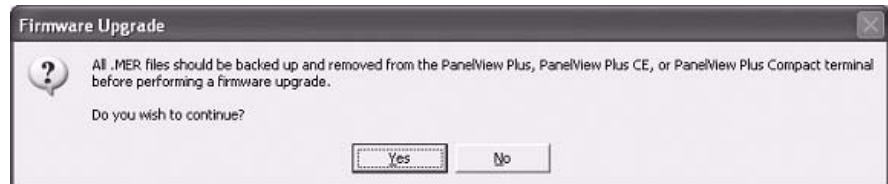

- Click Yes if you want to continue with the upgrade.

A dialog box shows the progress of the upgrade.

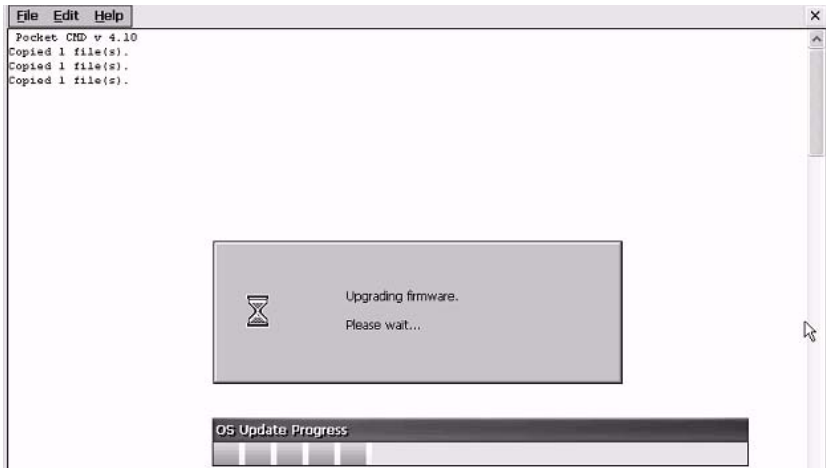

4. After the terminal resets **twice**, the new firmware is installed.
 - On touch-screen terminals, you must calibrate the touch screen after the first terminal reset by selecting pointers in all four corners of the screen and pressing the middle of the screen when prompted.
 - Communication settings are cleared when the terminal is upgraded. If Ethernet communication is used, reconfigure the Ethernet settings using the values recorded when preparing the terminal for the upgrade. Refer to [Preparing Terminal for Upgrade](#) on page 95.

IMPORTANT

Ignore this message if it appears during the upgrade.

Machine Edition may be corrupted. Do you want to download firmware?

It means FactoryTalk View Machine Edition has been removed from the terminal to install the upgrade. Do NOT touch the two buttons that appear with the message. Doing so could render the terminal inoperable.

5. Replace the .MER files that you backed up before starting the upgrade or download a new .MER file to the terminal.
6. Load the .MER file and run the project.

TIP

You can configure your application to start automatically on power cycle by accessing Terminal Settings>Startup Options in Configuration mode.

Upgrading Firmware over a Network Connection

You can upgrade firmware in a terminal that is connected to a computer using a direct serial connection or network connection.

- **Serial connection** requires a RAS connection to be set up on computer. During the RAS setup, you select the serial COM port. This option is used if the computer does not have RSLinx Enterprise installed or running. The serial connection is not supported on computers running the Windows Vista operating system.
- **Ethernet connection** requires that you enter the terminal's IP Address.
- **Network connection** requires RSLinx Enterprise software running on the computer and the terminal so you can select the terminal on an existing network.

Both the serial and Ethernet connection requires the File Transfer Utility running on the terminal.

Follow these steps to upgrade terminal firmware over a network using RSLinx Enterprise software and Ethernet communication.

1. Launch the Firmware Upgrade Wizard.

- Select Start>Programs>Rockwell Software>FactoryTalk View>Tools>ME Firmware Upgrade Wizard.
- Select Tools>Firmware Upgrade Wizard in FactoryTalk View Studio software.

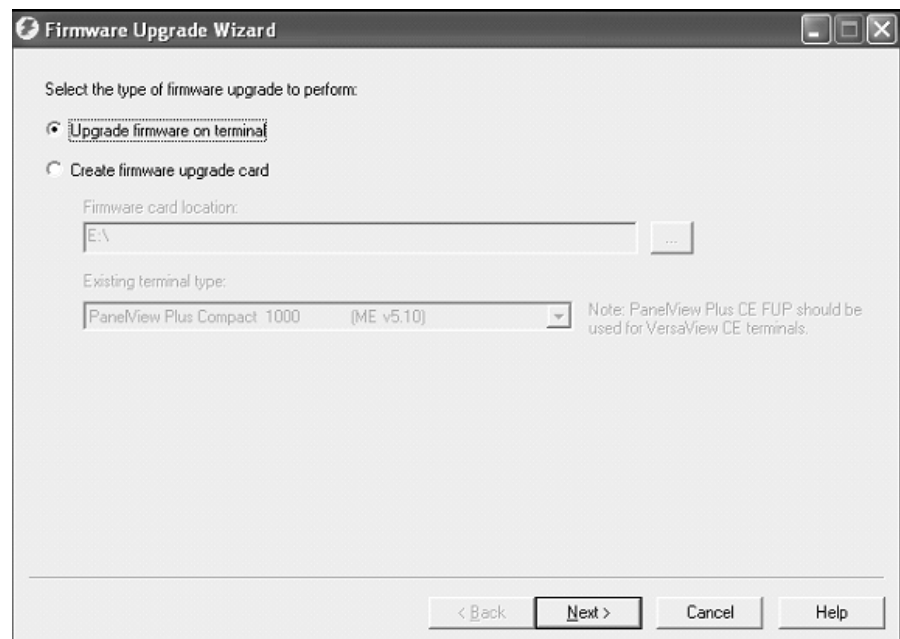

2. Select Upgrade firmware on terminal and click Next.

A dialog box reminds you to back up all .mer and user files before upgrading the terminal.

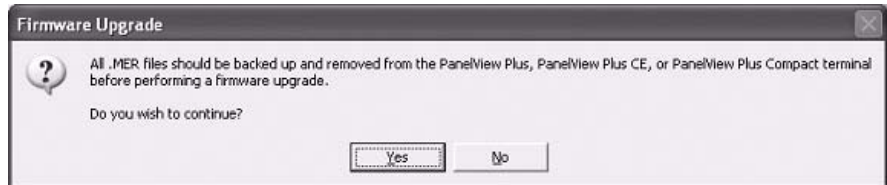

3. Click Yes if you want to continue with the upgrade.

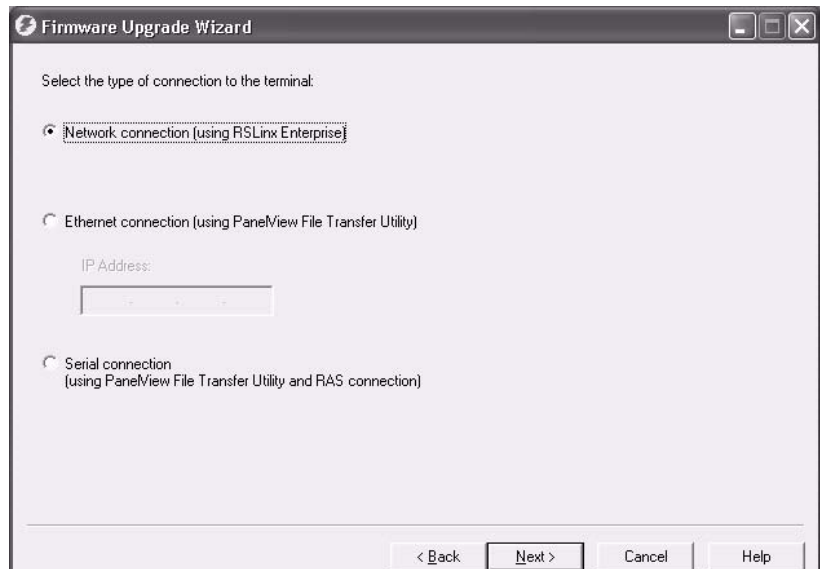

4. Select Network connection and click Next.

Use the Ethernet and Serial connections only if the firmware upgrade is unsuccessful.

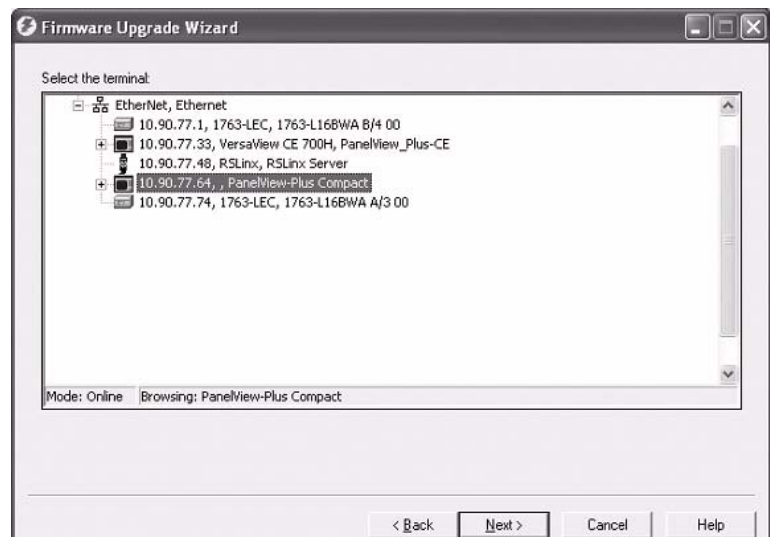

5. Select the terminal to be upgraded then click Next.

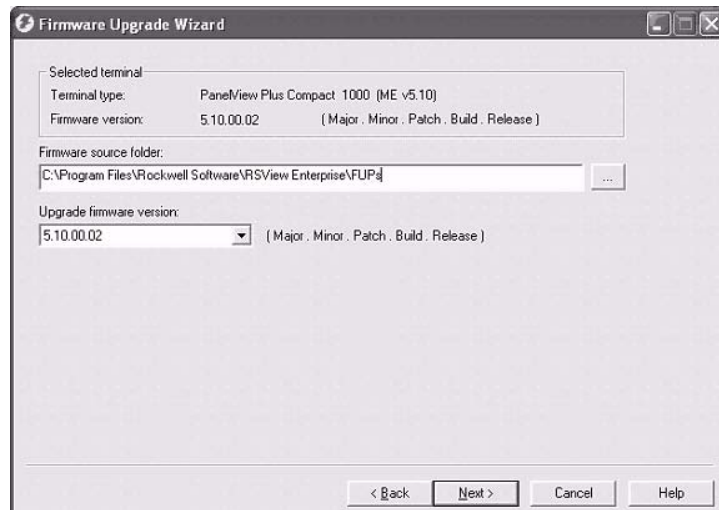

6. From the Firmware source folder text box, select the location of the firmware files.

The default location is C:\Program Files\Rockwell Software\RSView Enterprise\FUPs.

7. From the Upgrade firmware version list, select the firmware for the upgrade, then click Next.

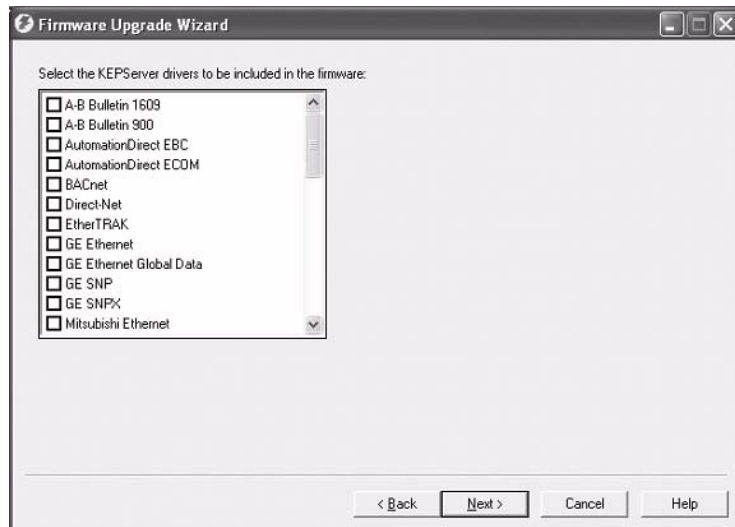

8. Select the appropriate KEPServer drivers, then click Next.

If no KEPServer drivers are needed, just click Next.

TIP

If the selected FUP file does not support the KEPServer drivers, this dialog box will not appear.

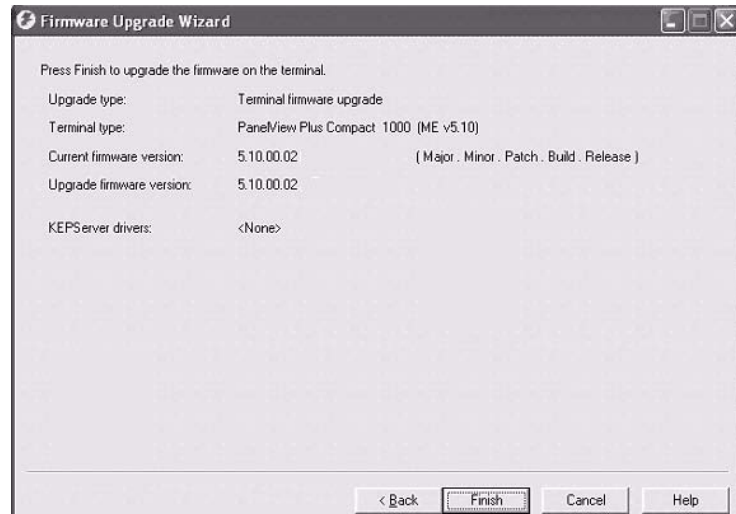

9. Click Finish to start the upgrade.

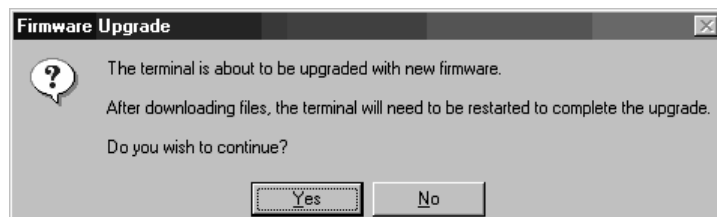

10. Click Yes to continue the upgrade process.

If the terminal was properly prepared for the upgrade, no applications should be running.

Firmware files are downloaded to the terminal. This may take several minutes to 15 minutes.

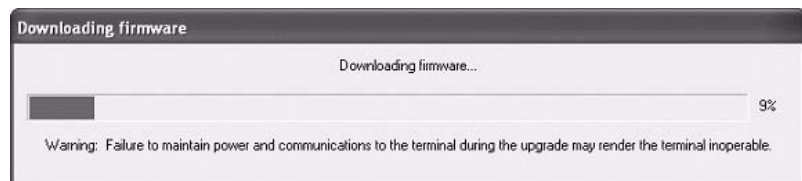

11. When the download is complete, click OK to reset the terminal.

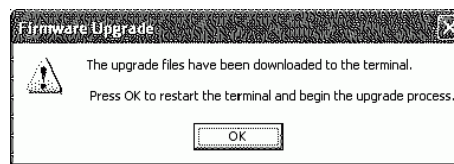

12. After the terminal resets twice, the new firmware is installed.
 - On touch-screen terminals, you must calibrate the touch screen after the first terminal reset by selecting pointers in all four corners of the screen and pressing the middle of the screen when prompted.
 - Communication settings are cleared when the terminal is upgraded. If Ethernet communication is used, reconfigure the Ethernet settings using the values recorded when preparing the terminal for the upgrade. Refer to [Preparing Terminal for Upgrade](#) on page 95.

IMPORTANT

Ignore this message if it appears during the upgrade.

Machine Edition may be corrupted. Do you want to download firmware?

It means FactoryTalk View Machine Edition has been removed from the terminal to install the upgrade. Do NOT touch the two buttons that appear with the message. Doing so could render the terminal inoperable.

13. Replace the .MER files that you backed up before starting the upgrade or download the new .MER files to the terminal.
14. Load the .MER file and run the project.

TIP

You can configure your application to start automatically on power cycle by accessing Terminal Settings>Startup Options in Configuration mode.

Troubleshooting

Chapter Objectives

This chapter provides information on how to isolate and correct common operating problems with system components.

- Status indicators
- Isolate the problem
- Startup error messages
- Startup information messages
- Startup sequence
- Check terminal components
- Ethernet connection
- Hardware compatibility errors
- Application does not run
- Configuration mode access

Status Indicators

The terminals have two status indicators to isolate operating problems.

- COMM indicator (green) for communication
- FAULT indicator (red) for hardware faults

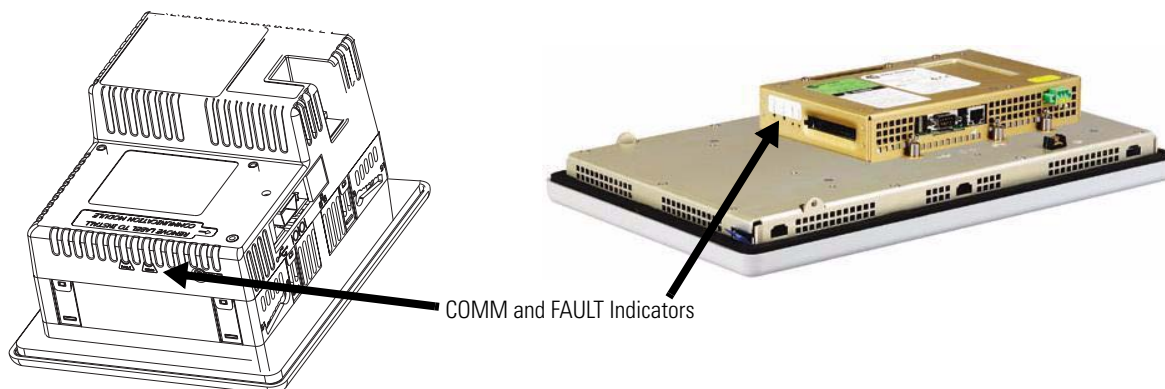

Isolating the Problem

This section provides general troubleshooting information to assist you when trying to isolate problems.

Check for Adequate Power

A terminal that does not receive adequate power could result in unpredictable behavior. Refer to [Appendix A](#), Specifications, for power requirements.

Check Indicators at Startup

After a successful startup, both status indicators on the terminal are off and controlled by the application running on the terminal.

When the terminal starts, the fault (red) indicator should be off except for a few brief flashes, and the comm (green) indicator on.

- If the indicators on the 1000 terminal remain off, the power supply or logic module has failed. Check the power cable. If the power is not within range, replace the power supply. If the power is within range, replace the logic module.
- If the indicators on the 400 and 600 terminals remain off, check the power cable.

Indicator States If Terminal Stops During Startup

Fault (Red) Indicator	Comm (Green) Indicator	Description
Blinking ⁽¹⁾	Off	Last firmware download failed. Reload firmware using Firmware Upgrade Wizard (FUW) utility.
	Blinking	EBC boot loader firmware failed or is missing. Reload firmware using Firmware Upgrade Wizard (FUW) utility.
	On	Windows CE OS firmware failed or is missing. Reload firmware using Firmware Upgrade Wizard (FUW) utility.
On ⁽²⁾	Off	Fatal hardware error occurred. For the 1000 terminals, replace the logic module. For the 400 or 600 terminals, replace the terminal.
	Blinking	Fatal hardware error in display. For the 1000 terminals, replace the display module. For the 400 or 600 terminals, replace the terminal.

⁽¹⁾ Blinking red indicates a recoverable error.

⁽²⁾ Solid red indicates a nonrecoverable or fatal error.

Check the Startup Messages for Errors

Record any error message that displays during startup. Refer to [Startup Error Messages](#) on page [110](#).

Check Voltages and Temperatures

To check the battery voltage and processor temperature, enter Configuration mode and select Terminal Settings>System Information>Terminal Information.

- The battery voltage must be at least 2.75V DC. Replace the battery if the voltage is less than 2.75V DC.
- The CPU temperature should be less than 95 °C.

To check the display temperature, select Terminal Settings>Display>Display Temperature.

- The display temperature should be less than 55 °C (131 °F).

If the CPU and display temperatures are higher, check for obstructed airflow in the chassis and attempt to moderate the ambient temperatures within the enclosure and surroundings.

Check the System Event Log

To check the system event log for errors or unexpected reboots, enter Configuration mode and select Terminal Settings>System Event Log.

Perform Extended Diagnostics

To perform more extensive hardware testing on the 1000 terminal at startup, enter Configuration mode and select Terminal Settings>Startup Tests>Select Tests.

Select one or more tests to run. Enable extended diagnostics and set the iteration or repeat count. Restart the terminal. The serial port test requires a loopback connector with these connections.

DB9 Connector (female)

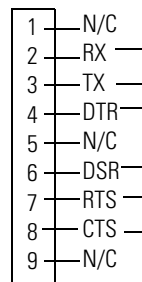

Extended diagnostics are performed at every startup until disabled. A failure will momentarily halt startup and display an error message.

Startup Information Messages

Startup messages display in a specific sequence on the terminal during startup and typically display for a few seconds. These messages indicate the startup sequence of the terminal, but do not require that you perform any action.

Message #	Displayed Message	Description
37 ⁽¹⁾	Video Initialized	Configures and initializes the graphics video system.
30	Watchdog Test	Tests the watchdog circuitry to verify system integrity.
1	RAM Test	Tests the RAM memory.
31 ⁽¹⁾	Stuck Key	Checks the integrity of the function key hardware.
31.5 ⁽¹⁾	Stuck Touch	Checks the integrity of the touch screen hardware.
32 ⁽¹⁾	Battery Test	Checks the integrity of the battery hardware.
2.5 ⁽¹⁾	Registry Search	Locates and loads the most recent, valid registry. Multiple copies of the registry are maintained. If power is lost during a registry update, a valid registry is available the next time power is applied to the terminal.
2	Image Search	Checks for new OS firmware upgrade on the external CompactFlash card and the serial port.
11 ⁽²⁾	Downloading Image	Downloads a new OS firmware upgrade to internal RAM. Message may remain on screen for several minutes.
50 ⁽¹⁾	External CF	Transfers a new OS firmware upgrade from the external CompactFlash card to the terminal. Message may display for several minutes.
20 ⁽²⁾	Transfer Image	Programs the OS firmware just downloaded into RAM. Message may remain on screen for several minutes.
23 ⁽¹⁾	Internal CF	Programs the OS firmware just downloaded into the internal flash memory. Message may display for several minutes.
24	CRC Check	Checks the integrity of the OS firmware.
27 ⁽²⁾	Decompress System	Decompresses the compressed OS firmware into RAM.
28	Starting System	Launches the operating system (OS).
29	System Check ###	Checks internal file system integrity (### is percent progress indicator).
29.1	System Check	Disables internal file system integrity check. Contact technical support.

⁽¹⁾ The status number and message displays only on the 100 terminals.

⁽²⁾ The status number and message displays only on the 400 and 600 terminals.

Startup Sequence

This flow chart provides a sequence of startup operations for the terminal and shows system information messages that are displayed on the terminal.

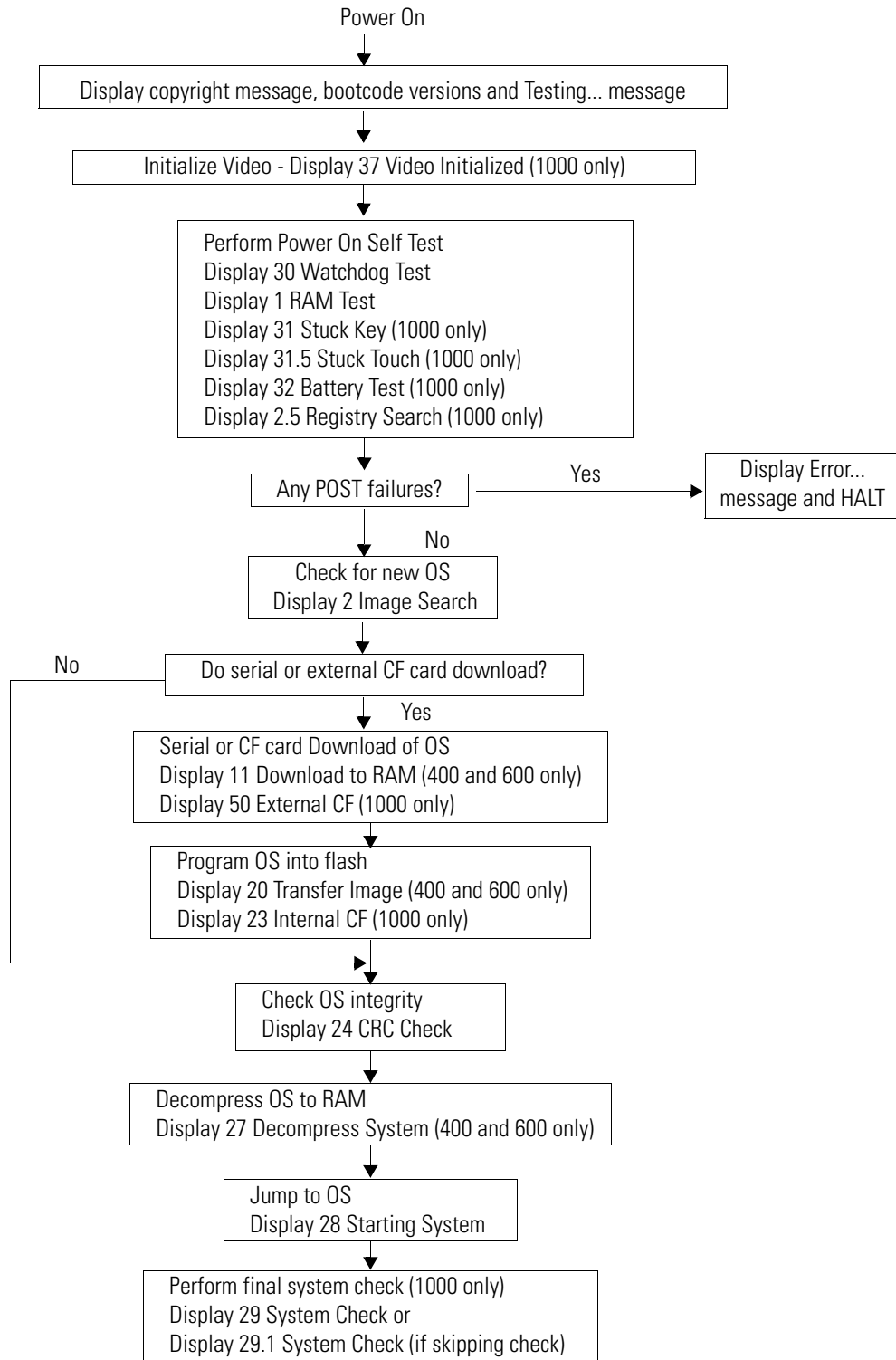

Startup Error Messages

When an error occurs, the terminal displays the error number with a text message. The word ERROR! appears under this line in different languages.

Displayed Message
ERROR! FEHLER! ERREUR! ERRORE!

Error #	Displayed Message	Description	Recommended Corrective Action
1	RAM Test	RAM Test failure	Reset the terminal. 400 and 600: If error persists, replace the terminal. 1000: If error persists, reseat the SO-DIMM RAM module. If error still persists, replace the logic module.
14 ⁽¹⁾	RAM Header Check	OS firmware that is downloading is not compatible with hardware.	Check that you are using the correct version and type of firmware upgrade. Reset the terminal and upgrade with the correct firmware version.
20 ⁽¹⁾	Transfer Image	Programming the downloaded OS firmware into flash failed.	Reset the terminal and attempt the firmware upgrade again. If error persists, replace the terminal.
23	Download Task ⁽¹⁾	OS firmware that is downloading to the terminal is too large.	Check that you are using the correct version and type of firmware upgrade. Reset the terminal and upgrade with the correct firmware version.
	Internal CF ⁽²⁾	Error programming the new OS firmware to internal CompactFlash.	Reload the firmware. If error persists, replace the internal CompactFlash. If error still persists, replace the logic module.
24	CRC Check	Checksum of the OS firmware failed.	Reload the firmware. 400 and 600: If error persists, replace the terminal. 1000: If error persists, replace the internal CompactFlash card. If error still persists, replace the logic module.
25 ⁽¹⁾	Invalid Prod Family	OS firmware that is downloading is not compatible with terminal.	Check that you are using the correct version and type of firmware upgrade. Reset the terminal and upgrade with the correct firmware version.
27 ⁽¹⁾	Decompress System	Error decompressing the OS firmware from flash to RAM.	Reload the firmware. If error persists, replace the terminal.
30	Watchdog Test	Watchdog test failure	Reload the firmware. 400 and 600: If error persists, replace the terminal. 1000: If error persists, replace the logic module.
31	Stuck Key	Function key failure	Check that nothing is pressed against a key. Reset the terminal without key presses. If error persists, replace display module.
31.5 ⁽²⁾	Stuck Touch	Touch screen failure	Check that nothing is pressed against the touch screen. Reset the terminal without touch screen presses. If error persists, replace the display module.
32 ⁽²⁾	Battery Test	Battery failure	Replace the battery. If error persists, replace the logic module.
33.5 ⁽²⁾	NVRAM Access	Nonvolatile memory failure	Upgrade the system firmware to revision 3.10.03 or later.
3a ⁽¹⁾	Stuck Touch	Touch screen failure	Check that nothing is pressed against the touch screen. Reset the terminal without touch screen presses. If error persists, replace the terminal.
40	EXE Check	System OS firmware is missing or corrupt.	Reload the firmware. 400 and 600: If error persists, replace the terminal. 1000: If error persists, replace the internal CompactFlash card. If error still persists, replace the logic module.
50 ⁽²⁾	External CF	Error loading the OS firmware from the external CompactFlash card.	Reload the firmware. If error persists, replace the external CompactFlash card and attempt the firmware upgrade again.

⁽¹⁾ The error number and message displays only on the 400 and 600 terminals.

⁽²⁾ The error number and message displays only on the 1000 terminals.

Checking Terminal Components

This section provides tips on how to isolate problems with the terminal display, touch screen, keypad, attached keyboard, or mouse.

Resolve Problems with Display

Symptom	Recommended Action	Page
The display is dim or unreadable.	Check the brightness setting on color displays. Enter Configuration mode and select Terminal Settings>Display>Display Intensity.	51
	Check the contrast setting on grayscale terminals. Enter Configuration mode and select Terminal Settings>Display>Display Contrast.	51
The backlight is turning off or dimming the display unexpectedly.	Check the screen saver settings. Enter Configuration mode and select Terminal Settings>Display>Screen Saver.	52
A startup error appears during startup.	Record the message and check the startup error messages table.	106

Resolve Problems with Touch Screen

Problem	Recommended Action	Page
The touch screen is not operating correctly.	<p>Calibrate the touch screen. Enter Configuration mode and select Terminal Settings>Input Devices>Touch Screen>Calibration. The calibration requires four user screen touches. When the touches do not converge to a satisfactory calibration, you are asked repeatedly for additional screen touches; the calibration does not terminate.</p> <p>A touch screen that does not calibrate is not present or not functioning properly. Replace the 1000 display module or the 400 to 600 terminal.</p>	56
The display may not have a touch screen.	Check the catalog number of the unit. Verify that your terminal has a touch screen by looking at the label on the terminal.	
The screen cursor is not visible.	Verify that the cursor is enabled. Enter Configuration mode and select Terminal Settings>Input Devices>Touch Screen>Cursor.	57
The touch screen does not accept touch input.	<p>Attach a USB mouse to check whether the problem is with the touch screen or the application.</p> <ul style="list-style-type: none"> • If the mouse works, but the touch screen does not, the touch driver or touch screen is not functioning properly. • If the mouse and touch screen are not working, then the problem is with the application. 	
Touch input and dragging is inaccurate. The touch screen is present and working but requires calibration.	Calibrate the touch screen. Enter Configuration mode and select Terminal Settings>Input Devices>Touch Screen>Calibration.	56

Resolve Problems with Keypad

Problem	Recommended Action	Page
<p>The hold-off delay may be longer than expected or multiple key presses might be inhibited by multi-key lockout.</p> <p>Home, End, Page Up or Page Down are not supported when single key or multi-key lockout is enabled.</p>	Check keypad settings. Enter Configuration mode and select Terminal Settings>Input Devices>Keypad.	55
The keypad is not accepting key input.	<p>Check the key input by attaching a USB keyboard.</p> <ul style="list-style-type: none"> • If the keyboard works but the keypad does not, then the keypad driver or keypad is not working. • If both the keypad and keyboard are not working, then the problem may be the application. 	

Resolve Problems with Mouse

Problem	Recommended Action	Page
The mouse is not operating correctly.	Check the USB cable and connection. Detach and reattach the mouse. Cycle power to the terminal.	
The screen cursor may not be visible or the mouse settings may need adjusting.	Check if the screen cursor is disabled. Enter Configuration mode and select Terminal Settings>Input Devices>Touch Screen>Cursor.	57
	Check the mouse settings. Enter Configuration mode and select Terminal Settings>Input Devices>Mouse.	55
The mouse is a keyboard/mouse USB composite device.	Attach a standalone USB mouse.	
The USB mouse may not be working or noncompliant.	<p>Replace the USB mouse. Try a different model or manufacturer. If attaching a new mouse resolves the problem, then the old mouse was not working or noncompliant.</p> <p>Refer to Appendix B for a list of valid USB devices that are compatible with the terminal.</p> <p>You can also check the Knowledgebase at the http://support.rockwellautomation.com site for a list of USB devices that are compatible with the terminal.</p>	121

Resolve Problems With Keyboard

Problem	Recommended Action	Page
The keyboard does not work.	Check the USB cable and connector. Detach and reattach the keyboard. Verify a good connection. Cycle power to the terminal.	
Keyboard keys may not be enabled as expected.	Check for enabled Alt-Ctrl keys. Enter Configuration mode and select Terminal Settings>Input Devices>Keyboard.	54
The keyboard is not accepting key input.	<p>Check the key input using the keypad.</p> <ul style="list-style-type: none"> • If the keypad works but the keyboard does not, the keyboard driver or keyboard is not working. • If both the keypad and keyboard are not working, the problem is probably with the application. 	
The keyboard is a keyboard/mouse USB composite device.	Attach a standalone USB keyboard.	
The USB keyboard may not be a compliant device.	<p>Replace the USB keyboard. Try a different model or manufacturer. If a new keyboard resolves the problem, then the old keyboard was probably noncompliant.</p> <p>Refer to Appendix B for a list of valid USB devices that are compatible with the terminal.</p> <p>You can also check the Knowledgebase at the http://support.rockwellautomation.com site for a list of USB devices that are compatible with the terminal.</p>	121

Ethernet Connection

This section provides tips on how to isolate Ethernet problems.

- **Check the status indicators at the Ethernet connector.**
Green indicates a communication link and should be ON.
Amber indicates data activity and should be flashing. Verify that there is a connection to the hub.
- **Check the cable connections and quality of cable.** Check for good connections and things such as quality, crimping, hub connection, and uplink ports.
- **Check the IP Address of the Built-in Ethernet Controller.**
Enter Configuration mode and select Terminal
Settings>Networks and Communications>Network
Connections>Network Adapters.

If DHCP is enabled, the device expects a valid IP address to be acquired within a several seconds after startup. The TCP/IP protocol automatically assigns 169.254.nnn.nnn when it fails to acquire an IP address from the server. In general, an IP address that begins with 169 will not support a network connection.

A bad Ethernet connection and the absence of a valid IP address are typically reported in a Communication error message box with the Winsock critical error 10065 - No route to host.

- **Check for conflicting IP addresses.** If DHCP is not enabled, make sure the IP address you specify is not in conflict with the address of another device on the network.
- **Check the device name of the terminal.** Do not allow devices on the network with same host name. Enter Configuration mode and select Terminal Settings>Networks and Communications>Network Connections>Device Name.
- **Contact your Network Administrator to check peer or server settings.** The other side of the Ethernet connection may also be a problem.

Hardware Compatibility

The PanelView Plus Compact 1000 terminal enforces a consistent hardware identity between the logic module and the internal CompactFlash (CF) card.

If the product identity of the logic module is PanelView Plus Compact 1000 but the CF card is not, this error is generated:

Fatal Error. The internal CF card is not compatible with the PVPlus Compact Logic Module. The CF card must be replaced to make the terminal usable.

If the product identify of the CF card is PanelView Plus Compact 1000 but the logic module is not, this error is generated:

Fatal Error. The internal PVPlus Compact CF card is not compatible with the Logic Module. The CF card must be replaced to make the terminal usable.

If either message occurs, power off the terminal and replace the internal CF card with one that has a product identity that matches the product identity of the logic module.

Application Does Not Load

You cannot load a regular Machine Edition application created for a PanelView Plus terminal on a PanelView Plus Compact terminal. If you do, this dialog box appears:

**TIP**

You can load a Compact Machine Edition application created for a PanelView Plus Compact terminal on a PanelView Plus terminal.

Application Does Not Run

If a compact application does not run on the terminal, there may be a problem with the FactoryTalk View ME application. Verify that a startup screen was configured and that the runtime file is a compatible version.

Configuration Mode Access

To access Configuration mode while an application is running, your FactoryTalk View ME application must contain a screen with a Goto Configure Mode button. When the application is running, you can press this button to access Configuration mode.

If a running application does not contain a Goto Configure Mode button, you can access configuration mode during startup.

1. Restart the terminal.

The terminal goes through its startup sequence and will display a white box in the lower left corner of the display.

2. On touch screen terminals, press the white box.
On keypad terminals, press the F1 key.

The terminal enters Configuration Mode.

TIP

If the terminal is configured to enter Configuration mode at startup and does not, then reload the firmware.

Specifications

Electrical

Attribute	Value
400 and 600 Input voltage, DC Power consumption, DC	24V DC nom (18...30V DC) 25 W max (1.0 A at 24V DC)
1000 Input voltage, DC Power consumption, DC	24V DC nom (18...32V DC) 70 W max (2.9 A at 24V DC), 39 W typical (1.6A @ 24V DC)

Environmental

Attribute	Value
Temperature, operating	0...55 °C (32...131 °F)
Temperature, non-operating	-25...70 °C (-13...158 °F)
Heat dissipation 400 and 600 1000	85 BTU/hr 240 BTU/hr
Relative humidity	5...95% without condensation
Altitude, operating	2000 m (6561 ft)
Shock, operating	15 g at 11 ms
Shock, nonoperating	30 g at 11 ms
Vibration	10...57 Hz, 0.012 pk-pk displacement 57...500 Hz, 2 g pk acceleration
Enclosure Ratings	NEMA Type 12, 13, 4X (Indoor use only), IP54, IP65

Display

Attribute	Value
Display type 400 and 600 grayscale 400, 600, 1000 color	Grayscale passive matrix, film compensated super-twist nematic (FSTN) Color active matrix, thin-film transistor (TFT) liquid crystal display (LCD)
Display size, diagonal 400 grayscale 400 color 600 1000	3.8 in. 3.5 in. 5.5 in. 10.4 in.
Display area (WxH) 400 grayscale 400 color 600 grayscale and color 1000	77 x 58 mm (3.0 x 2.3 in.) 71 x 53 mm (2.8 x 2.1 in.) 112 x 84 mm (4.4 x 3.3 in.) 211 x 158 mm (8.3 x 6.2 in.)
Resolution 400 grayscale and 400 color 600 1000	320 x 240 320 x 240 640 x 480
Luminance (typical) 400 grayscale 400 color 600 and 1000 color	120 cd/m ² Nits 200 cd/m ² Nits 300 cd/m ² Nits
Backlight 400 600 and 1000	LED CCFL 50,000 hours life, min.
Touch screen Actuation rating Operating force	Analog resistive 1 million presses 10...110 g
Keypad function keys ⁽¹⁾ Actuation rating Operating force	Function keys, numeric and navigation 1 million presses 340 g

⁽¹⁾ Number of function keys varies by terminal size.

Mechanical

Attribute	Value
Weight, approx. 400 keypad or keypad and touch 600 touch 1000 touch	562 g (1.24 lb) 789 g (1.74 lb) 2.9 kg (6.3 lb)
Dimensions, approx. HxWxD 400 keypad or keypad and touch 600 touch 1000 touch	152 x 185 x 90 mm (6.0 x 7.28 x 3.54 in.) 152 x 185 x 98 mm (6.0 x 7.28 x 3.86 in.) 248 x 329 x 55 mm (9.77 x 12.97 x 2.18 in.)

General

Attribute	Value
Battery life 400 and 600 1000	5 years min. at 25 °C (77 °F) 4 years min. at 25 °C (77 °F)
Clock	Battery-backed, +/-2 minutes per month
LED indicators	COMM (Green), Fault (Red)
Application flash memory 400 and 600, series B or later 1000	20 MB 25 MB
External CompactFlash storage	512 MB max

Agency Certifications

Certifications ⁽¹⁾	Value
c-UL-us	UL Listed Industrial Control Equipment, certified for use in US and Canada. See File E10314. UL Listed Industrial Control Equipment for use in: <ul style="list-style-type: none"> • Class I, Div 2, Groups A, B, C, D • Class II, Div 2 Groups F, G • Class III Hazardous Locations
CE (EMC)	European Union 2004/108/EC Directive, compliant with: EN 61000-6-2; Industrial Immunity EN 61000-6-4; Industrial Emissions
CE (LVD)	European Union 2006/95/EC Low Voltage Directive, compliant with: EN 61131-2; Programmable Controllers
C-Tick	Australian Radiocommunications Act, compliant with: AS/NZS CISPR 11; Industrial Emissions

⁽¹⁾ See the Product Certification link on <http://ab.com> for declarations of conformity, certificates, and other certification details.

USB Devices

Compatible USB Devices

The table provides a list of compatible USB devices that can be used on the USB ports of the terminals.

Device	Vendor	Model	PanelView Plus Compact 1000	PanelView Plus Compact 400/ 600
USB Keyboard	Rockwell Automation	Cat. No. 6189-KBDEPU1U	Yes	Yes
	Ortek	MCK-600USB	Yes	Yes
	Dell	RT7D10	Yes	Yes
USB Keyboard/Mouse	Rockwell Automation	Cat. No. 6189-KBDEPC1U	Yes	No
USB Mouse	Logitech	Optical Mouse - M-BJ58	Yes	Yes
	Microsoft	Intellimouse D58-00026	Yes	Yes
	Atek	USB Mouse	Yes	No
	VersaView (Rockwell Automation)	USB Mouse	Yes	Yes
USB Hub	Belkin	USB 4-Port Hub - ESU021	Yes	Yes

Available Fonts

The following fonts are pre-installed on the PanelView Plus terminals:

- True Type fonts (scalable)
 - Tahoma.ttf (proportional)
 - Courier.ttf (fixed width)
 - Arial.ttf (proportional)
- 23 fonts of various sizes migrated from PanelView Standard and PanelView e terminals (various sizes)

To simplify the creation and downloading of .mer application files on these devices, use the above list of fonts when developing screens in FactoryTalk View Studio software.

Additional fonts are available in FactoryTalk View Studio software when developing application screens.

- If the font used to develop screens is not available on the target device, the closest font is selected.
- If bold or italics is used, and a separate bold or italics font is unavailable, then the target operating system will use an algorithm to produce these affects.

In either case, the device screens will look different than they do in FactoryTalk View Studio software.

Download Fonts to Terminal

To use additional fonts on a PanelView Plus device, copy any of the font files on the Machine Edition Fonts CD to this directory on the computer where FactoryTalk View Studio software is installed:

```
c:\Documents and Settings\All Users\Documents\RSView Enterprise\ME\Runtime
```

You can now use the File Transfer Utility in FactoryTalk View Studio software to download the font files to the target device.

1. Select Tools>Transfer Utility.
2. Select Source File>True Type Fonts.
3. Select a font file to download to the device and press the Download button.

Machine Edition Fonts CD

Additional fonts are available on the Machine Edition Fonts CD. This CD is available from your local distributor by requesting View-SP006.

For more information, refer to the Rockwell Automation Knowledgebase at <http://support.rockwellautomation.com>.

Available Fonts	File Name	Size (Bytes)
Arial		
Arial (Subset 1_30)	arial_1_30.ttf	153,720
Arial Black	arialk.ttf	117,028
Arial Bold	arialbd.ttf	288,496
Arial Bold Italic	arialbi.ttf	226,748
Arial Italic	ariali.ttf	207,808
Comic Sans MS		
Comic Sans MS	comic.ttf	126,364
Comic Sans MS Bold	comibd.ttf	111,476
Courier New		
Courier New (Subset 1_30)	cour_1_30.ttf	162,460
Courier New Bold	courbd.ttf	312,920
Courier New Bold Italic	courbi.ttf	236,148
Courier New Italic	couri.ttf	245,032
Georgia		
Georgia	georgia.ttf	149,628
Georgia Bold	georgiab.ttf	141,032
Georgia Bold Italic	georgiaz.ttf	159,736
Georgia Italic	georgiai.ttf	157,388
Impact	impact.ttf	136,076
Kino	kino.ttf	28,872
MSLogo	mslogo.ttf	2,500
Symbol	symbol.ttf	69,464
Tahoma		
Tahoma (Subset 1_07)	tahoma_1_07.ttf	123,980
Tahoma Bold	tahomabd.ttf	295,432
Times New Roman		
Times New Roman (Subset 1_30)	times_1_30.ttf	184,976
Times New Roman Bold	timesbd.ttf	334,944
Times New Roman Bold Italic	timesbi.ttf	239,692
Times New Roman Italic	timesi.ttf	248,368
Trebuchet MS		
Trebuchet MS	trebuc.ttf	69,688
Trebuchet MS Bold	trebucbd.ttf	66,444
Trebuchet MS Bold Italic	trebucbi.ttf	66,348
Trebuchet MS Italic	trebucit.ttf	72,560

Available Fonts	File Name	Size (Bytes)
Verdana		
Verdana	verdana.ttf	149,752
Verdana Bold	verdanab.ttf	137,616
Verdana Bold Italic	verdanaz.ttf	154,800
Verdana Italic	verdanai.ttf	155,076
Webdings	webdings.ttf	118,752
Wingding	wingding.ttf	81,000
Chinese (Simplified) Locale Specific Support		
Simsun & NSimSun		
Simsun & NSimSun	simsun.ttc	10,500,400
Simsun & NSimSun (Subset 2_50)	simsun_2_50.ttc	3,051,024
Simsun & NSimSun (Subset 2_60)	simsun_2_60.ttc	3,578,692
Simsun & NSimSun (Subset 2_70)	simsun_2_70.ttc	6,975,948
Simsun & NSimSun (Subset 2_80)	simsun_2_80.ttc	8,116,188
Simsun & NSimSun (Subset 2_90)	simsun_2_90.ttc	9,066,640
SC_Song	sunfon.ttf	4,686,044
Chinese (Traditional) Locale Specific Support		
MingLiU & PMingLiU (Choose 1)		
MingLiU & PMingLiU	mingliu.ttc	8,822,400
MingLiU & PMingLiU (Subset 2_70)	mingliu_2_70.ttc	4,786,488
MingLiU & PMingLiU (Subset 2_80)	mingliu_2_80.ttc	5,772,700
MingLiU & PMingLiU (Subset 2_90)	mingliu_2_90.ttc	7,354,808
MSMing	msming.ttf	3,172,552
Japanese Locale Specific Support		
MS Gothic		
MS Gothic & P Gothic & UI Gothic	msgothic.ttc	8,272,028
MS Gothic & P Gothic & UI Gothic (Subset 1_50)	msgothic_1_50.ttc	4,456,536
MS Gothic & P Gothic & UI Gothic (Subset 1_60)	msgothic_1_60.ttc	6,057,400
MS Gothic & P Gothic & UI Gothic (Subset 1_70)	msgothic_1_70.ttc	3,795,500
MS Gothic & P Gothic & UI Gothic (Subset 1_80)	msgothic_1_80.ttc	5,438,776
MS Gothic & P Gothic & UI Gothic (Subset 1_90)	msgothic_1_90.ttc	6,408,352
MS Gothic & P Gothic (Subset 30)	msgothic30.ttc	4,197,524
MS Gothic & P Gothic (Subset 30_1_19)	msgothic30_1_19.ttc	3,304,056
Korean Locale Specific Support		
GL_CE	gl_ce.ttf	4,130,084
Gulim & GulimChe (Choose 1)		
Gulim & GulimChe (Subset 1_30)	gulim_1_30.ttc	3,010,268
Gulim & GulimChe (Subset 1_40)	gulim_1_40.ttc	4,683,896
Gulim & GulimChe (Subset 1_50)	gulim_1_50.ttc	7,128,756
Gulim & GulimChe (Subset 1_60)	gulim_1_60.ttc	9,360,100

A

- accessories** 11
- antiglare overlays** 12
- application**
 - loading .MER 35
 - running 36

B

- backlight**
 - brightness 51
 - control 50
 - replacement 11, 79
- battery replacement** 12, 76
- bezel replacement** 12, 83

C

- cables** 12
 - runtime communication cables 87
- catalog numbers** 9
- cleaning display** 85
- communication**
 - cables 87
 - Ethernet 93
 - serial 90
 - USB ports 89
- configuration mode**
 - accessing 31
 - loading application 35
 - running application 36
 - terminal settings 36
- copying files**
 - applications 48
 - font files 48

D

- date** 69, 73
- DC power**
 - connecting 28
 - ratings 117
- deleting files**
 - applications 47
 - font files 47
 - log files 47
- DF1**
 - cables 87
- diagnostics** 45
- display**
 - troubleshooting 111

display settings

- configuration mode 50

E

- enclosures** 16
- Ethernet**
 - cables 87
 - connector pinout 93
 - port 93
 - troubleshooting 114
- external compact flash cards** 11, 81

F

- FactoryTalk View ME** 10
- firmware upgrade**
 - creating a firmware upgrade card 96
 - using a firmware upgrade card 98
- fonts**
 - linking 53
 - pre-installed 123

H

- hardware** 10
- hardware compatibility** 115
- hazardous locations** 13
 - USB port 14

I

- IGMP Protocol** 94
- input devices** 55
- input panel** 34
- installation** 13
 - ambient temperature 17
 - clearances 17
 - cutout dimensions 17
 - hazardous locations 13
 - panel installation 1000 terminal 20
 - panel installation 400-600 18
- IP address** 42

K

- keyboard**
 - compatibility 121
 - mouse compatibility 121
 - troubleshooting 113
- keypad** 11
 - troubleshooting 112

L

languages 71
loading application 35

M

messages
startup information 108
mouse 55, 57, 89
compatible 121
troubleshooting 112

N

network adapters 12
network connections 87

P

power supply, external 26
power terminal block 24
print setup
for alarms 58
for diagnostic messages 58
for displays 58
product dimensions 22
product label 82

R

resetting terminal 29

S

serial communication
computer connection 92
connections 90
DF1 90
null modem cable 91
ports 90
printing 90, 92
transferring applications 90
using a modem 91
SNMP Protocol 94
software supported 10
specifications
agency certifications 119
display 118
electrical 117
environmental 117
mechanical 118

startup

error messages 110
information messages 108
problem entering configuration mode 116
sequence 109

status indicators 105

support 68

system

event log 65

T

terminal information 66

terminal settings 36

date 69
diagnostics 45
long date format 74
short date format 73
system event log 65
terminal info 66
time 69
time format 72
time zone 70

time 69, 72

touch screen 11

cursor enable 57
double-tap sensitivity 57

transferring files 48

troubleshooting 105

accessing configuration mode 116
display module 111
Ethernet connection 114
general 106
hardware compatibility 115
keyboard 113
keypad 112
mouse 112
startup error messages 110
startup information messages 108
status indicators 105

U

USB devices 121

USB ports 14, 89

compatible 121
connector pinouts 89

W

wiring and safety guidelines 23

Rockwell Automation Support

Rockwell Automation provides technical information on the Web to assist you in using its products. At <http://support.rockwellautomation.com>, you can find technical manuals, a knowledge base of FAQs, technical and application notes, sample code and links to software service packs, and a MySupport feature that you can customize to make the best use of these tools.

For an additional level of technical phone support for installation, configuration, and troubleshooting, we offer TechConnect support programs. For more information, contact your local distributor or Rockwell Automation representative, or visit <http://support.rockwellautomation.com>.

Installation Assistance

If you experience a problem within the first 24 hours of installation, please review the information that's contained in this manual. You can also contact a special Customer Support number for initial help in getting your product up and running.

United States	1.440.646.3434 Monday – Friday, 8am – 5pm EST
Outside United States	Please contact your local Rockwell Automation representative for any technical support issues.

New Product Satisfaction Return

Rockwell Automation tests all of its products to ensure that they are fully operational when shipped from the manufacturing facility. However, if your product is not functioning and needs to be returned, follow these procedures.

United States	Contact your distributor. You must provide a Customer Support case number (call the phone number above to obtain one) to your distributor in order to complete the return process.
Outside United States	Please contact your local Rockwell Automation representative for the return procedure.

www.rockwellautomation.com

Power, Control and Information Solutions Headquarters

Americas: Rockwell Automation, 1201 South Second Street, Milwaukee, WI 53204-2496 USA, Tel: (1) 414.382.2000, Fax: (1) 414.382.4444

Europe/Middle East/Africa: Rockwell Automation, Vorstlaan/Boulevard du Souverain 36, 1170 Brussels, Belgium, Tel: (32) 2 663 0600, Fax: (32) 2 663 0640

Asia Pacific: Rockwell Automation, Level 14, Core F, Cyberport 3, 100 Cyberport Road, Hong Kong, Tel: (852) 2887 4788, Fax: (852) 2508 1846