

Selection Guide 0.25 kW – 400 kW VLT® AutomationDrive FC 301/302

98%

Energy efficiency

Save energy and money with up to 98% efficient VLT® drives.

VLT®
AutomationDrive





This brochure
covers
0.25 – 400 kW

For drives
from 400 kW
to 1.4 MW consult
the VLT® High
Power Drives
Selection Guide

Consistency. Reliability. Versatility. And all the power you need.

The VLT® AutomationDrive is a globally supported drive concept that provides exceptional control of all motor driven applications.

From standard to permanent magnet motors on any industrial machine or production line; regardless of where a VLT® AutomationDrive FC 301/302 is installed, it saves expensive energy, increases flexibility and strengthens reliability for its owners.

Reduce project costs, ensure the lowest possible cost of ownership and maintain high efficiency processes with a premier, proven and future-ready motor control solution.

Every VLT® AutomationDrive is based on 45 years of experience and innovation. Easy to use, all models follow the same basic design and operating principle. Once you know one, you know them all. This selection guide helps you choose and configure your perfect drive for applications from 0.25-400 kW.



**50° C ambient temperature
without derating**

**Control motors down to
0.37 kW without a step-down
transformer on 690 V mains.**



GLOBAL REACH

Danfoss' efficient global logistics setup makes it possible to ship VLT® drives quickly to any destination.

Danfoss' global support organization is geared to react swiftly to resolve issues to help you reduce downtime. In the event of issues Danfoss' global hotline helps you find the right solution quickly and efficiently.

In order to provide fast support in major industrial areas Danfoss is also present with highly trained, dedicated professionals. Based close to chemical hotspots, marine hubs and major industrial areas around the world, Danfoss experts are ready to provide fast access to drive and application expertise.

TRAINING BASED ON EXPERIENCE

Keep up to date on trends, methods and features that save additional energy or offer new technical opportunities to increase your product quality or decrease the downtime of your plant.

Receive the same quality training anywhere in the world with Danfoss-developed material and trainers. Training can take place at one of Danfoss' facilities or directly at the customer's own facility. Teaching is conducted by local trainers who have broad experience in the many conditions that may affect performance, so you get the most out of your Danfoss solution.

Additionally, the online platform Danfoss Learning offers you the opportunity to extend your knowledge in small and compact lessons up to extensive training courses, when and wherever you want.

Read more at learning.danfoss.com

Flexible, modular and adaptable

Built to last

A VLT® AutomationDrive is built on a flexible, modular design concept to provide an extraordinarily versatile motor control solution. The drives is equipped with a wide range of industry features that enable optimal process control, higher quality output and reduce costs related to spare parts and service.

Up to 1.4 MW

Available in a power range from 0.25 kW to 1.4 MW the VLT® AutomationDrive FC 300 series can control nearly all standard industrial motor technologies, including permanent magnet motors, copper rotor motors and direct line PM.

The frequency converter is designed to work with all common supply voltages: 200-240 V, 380-480/500 V, 525-600 V and 525-690 V. This means that system designers, OEMs and end users are free to connect the drive to their chosen motor and remain confident that the system will perform to the highest possible standards.

690 V

The 690 V versions of VLT® AutomationDrive FC 302 units for the power range from 1.1 kW up to 75 kW can control motors down to 0.37 kW without step-down transformer. This enables you to choose from a broad variety of compact, reliable and efficient drives for demanding production facilities operating from 690 V mains networks.

Reduce costs with compact drives

A compact design and efficient heat management enable the drives to take up less space in control rooms and

panels, thereby reducing initial costs. Compact dimensions are also an advantage in applications where drive space is restricted. This makes it possible for designers to develop smaller applications without being forced to compromise on protection and grid quality. For example, the D frame versions of the VLT® AutomationDrive FC 302 from 90-400 kW are 25-68% smaller than equivalent drives.

Especially impressive is the 250 kW, 690 V version, which is the smallest in its power class on the market today, and is available in an IP 54 enclosure.

Despite the compact dimensions, all units are nevertheless equipped with integrated DC link chokes and EMC filters, which help to reduce grid pollution and reduce cost and efforts for external EMC-components and wiring.

The IP 20 version is optimized for cabinet mounting and features covered power terminals to prevent accidental contact. The unit can also be ordered with optional fuses or circuit breakers in the same package size. Control and power cables are fed in separately at the bottom.

The frequency converters combine a flexible system architecture, which allows them to be adapted to specific applications, with a uniform user interface across all power classes. This allows you to adapt the drive to the exact needs of your specific application. As a result project work and costs are subsequently reduced. The easy to use interface reduces training requirements. The integrated SmartStart guides users quickly and efficiently through

the setup process, which results in fewer faults due to configuration and parameterization errors.



VLT® PLATFORM HIGHLIGHTS

- **Versatile, flexible, configurable**
- **Up to 1.4 MW in common voltages**
- **Asynchronous & PM motor control**
- **14 fieldbuses supported**
- **Unique user interface**
- **Globally supported**
- **EMC filters integrated as standard**

Available in any size and all protection classes

All Danfoss VLT® frequency converters are designed for efficient and cost saving cooling.

VLT® AutomationDrives are available in a broad range of enclosures sizes and protection ratings from IP 20 to IP 66 to enable easy installation in all environments: mounted in panels, switch rooms or as stand-alone units in the production area.

Cost saving heat management

In VLT® AutomationDrives there is total separation between cooling air and the internal electronics. It protects electronics from contaminants. At the

same time it removes heat efficiently which helps to prolong product life, increase the overall availability of the system and reduce faults related to high temperatures.

For example, by exhausting heat directly outside it is possible to reduce the size of the cooling system in the panel or switch room. This can be achieved with Danfoss' panel through cooling system or the extremely efficient back channel cooling concept,

that also allows to conduct the heat into the outside of the control room. Both methods make it possible to reduce the initial cost of the panel or switch room.

In daily use the benefits are equally clear as the energy consumption related to cooling can be reduced significantly. This means that designers can reduce the size of the air conditioning system, or even eliminate it entirely.

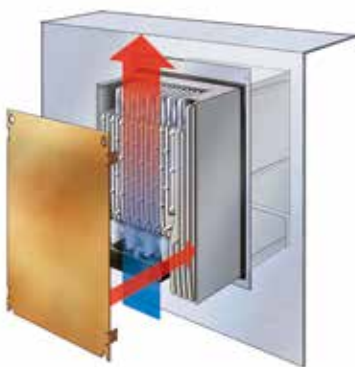

PANEL THROUGH COOLING

An accessory mounting kit for small and mid-range drives enables heat losses to be dissipated directly outside the panel room.



BACK CHANNEL COOLING

By directing air through a rear cooling channel up to 85-90% of the drive's heat loss is removed directly outside the installation room.



NO AIR OVER ELECTRONICS

Complete separation between cooling air and the internal electronics ensure efficient cooling.



VLT® AutomationDrives are available in all enclosure ratings from IP 20 to IP 66.

Coated circuit boards

The VLT® AutomationDrive is as standard conforming to class 3C2 (IEC 60721-3-3). If used in especially harsh conditions it is possible to order a special coating that complies with class 3C3.

Ruggedized for extra protection

The VLT® AutomationDrive is available in a 'ruggedized' version, that ensures that components remain firmly in place in environments characterized by high degrees of vibration such as Marine and mobile equipment.

RETROFITTING. FAST UPGRADE TO NEWEST TECHNOLOGY PLATFORM



As technologies evolve and newer, smaller and more efficient models replace old drives, it is important to Danfoss that you can change and upgrade as easily as possible. Minimize downtime in your production and update your installation in a few minutes with prepared tools from Danfoss. With a Danfoss conversion kit it is easy and fast to prepare your application for the future:

- Mechanical adaptation
- Electric adaptation
- Parameter adaptation
- Profibus adaptation

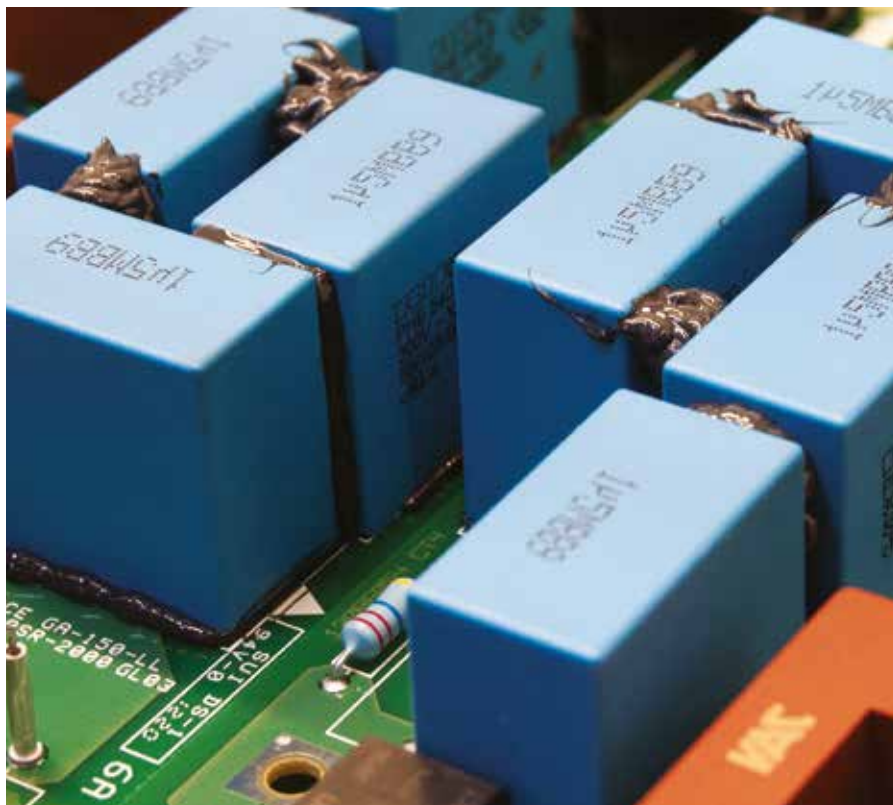



**Danfoss VLT®
AutomationDrives
are equipped with DC
chokes that reduce
mains interference
to a THDi of 40%.**

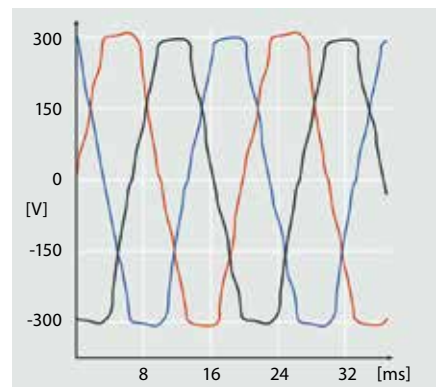

*HARMONIC DISTORTION
High inverter loads without mitigation
affect mains quality.*

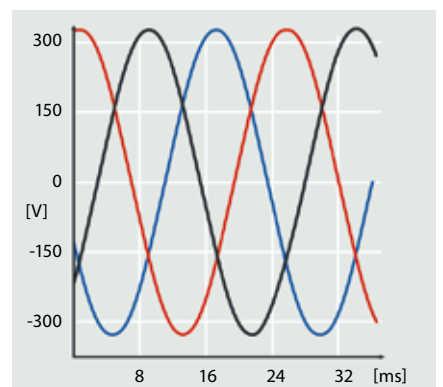

*OPTIMISED HARMONIC
PERFORMANCE
Efficient harmonic mitigation protects
electronics and increases efficiency.*



Optimize performance and grid protection

Built-in protection as standard

The VLT® AutomationDrive FC 300 contains all modules necessary for compliance with EMC standards.

A built-in scalable RFI filter minimizes electromagnetic interference. Integrated DC chokes reduce harmonic distortion in the mains network, which increases the lifetime of the DC link capacitors and the drive system's overall efficiency.

The solutions save cabinet space, as they are integrated in the drive from the factory. Efficient EMC mitigation also enables the use of cables with smaller cross-sections, which again reduces installation costs.

Expand grid protection with filter solutions

If needed, Danfoss' wide range of solutions for harmonic mitigation can provide additional protection, such as the

- VLT® Advanced Harmonic Filter AHF
- VLT® Advanced Active Filter AAF
- VLT® Low Harmonic Drives
- VLT® 12-pulse Drives

Provide motor protection with:

- VLT® Sine Wave Filter
- VLT® dU/dt Filter

With this solutions you may achieve optimum performance for your application, even in weak or unstable grids.

Use motor cables up to 300 m

The design of the VLT® AutomationDrive makes it a perfect choice in applications that require long motor cables. Without needing additional components the drive provides trouble free operation with cable lengths of up to 150 m screened or 300 m unscreened. This allows the drive to be installed in a central control room a distance away from the application without affecting motor performance.



EMC Standards		Conducted emission		
Standards and requirements	EN 55011 Facility operators must comply with EN 55011	Class B Housing and light industries	Class A Group 1 Industrial environment	Class A Group 2 Industrial environment
	EN/IEC 61800-3 Converter manufacturers must conform to EN 61800-3	Category C1 First environment, home and office	Category C2 First environment, home and office	Category C3 Second environment
FC 301/302 compliance ¹⁾		■	■	■

¹⁾ Compliance to mentioned EMC classes depends on the selected filter

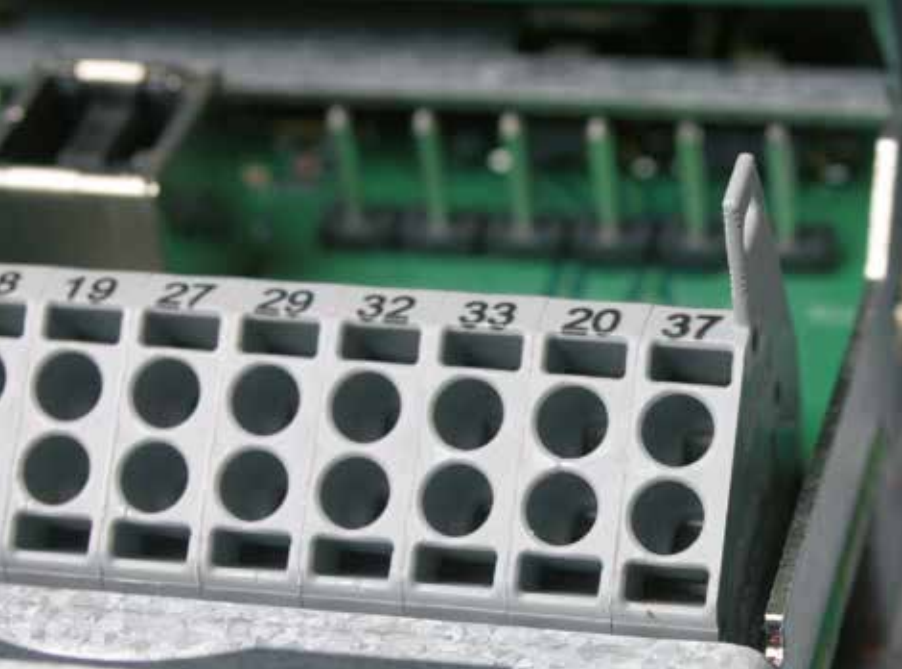

Terminal 37 can be used as "safe coast" for Safe Stop.

Safety solutions today span from Safe Torque Off (STO) functionality to extensive safety systems. What is important is that the chosen solution easily can be integrated in existing machine concepts.

Tailored safety

Protect both equipment and operators

The VLT® AutomationDrive FC 302 is delivered as standard with the STO (Safe Torque Off) function in compliance with ISO 13849-1 PLd and SIL 2, according to IEC 61508/IEC 62061.

This safety function can be extended to include SS1, SLS, SMS, SSM, safe jog mode, etc. with the VLT® Safety Option MCB 140 Series and VLT® Safety Option MCB 150 Series.

VLT® Safety Option MCB 140

The MCB 140 option is an easy to mount internal or external safety module.

Programming is fast and easy via three buttons which enables users to set a limited number of parameters which are handled independently of the drive control algorithm. The module can be used in high demand applications according to ISO 13849-1 up to PL e, providing functions such as Safe Stop 1 (SS1), Safely Limited Speed (SLS) and

Safe Maximum Speed (SMS), control of external contactors and safety door monitoring and unlocking.

VLT® Safety Option MCB 150

The VLT® Safety Option MCB 150 is integrated directly in the frequency converter and is prepared for future connection to common safety bus systems. The module is certified according to ISO 13849-1 up to PLd as well as IEC 61508/IEC 62061 up to

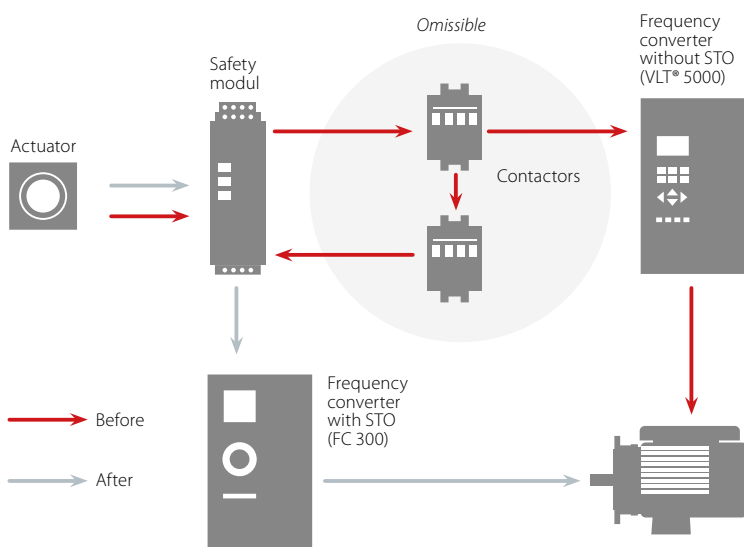

Two contactors can be omitted in safety installations due to the safety functionality in VLT® AutomationDrive.



VLT® Safety Option MCB 140



VLT® Safety Option MCB 150



Increase flexibility with the VLT® Motion Control Option

SIL 2 and provides SS1 and SLS (SMS) functionality. The option can be used in low and high demand applications. SS1 offers ramp and time based functionality. SLS can be configured both with and without ramp down on activation.

Parameter configuration is fully integrated into the Danfoss VLT® Motion Control Tool MCT 10 frequency converter engineering tool and enables simple start-up and easy maintenance. Key advantages are easy diagnosis and certification documentation necessary for safety acceptance tests, which are supported by the engineering tool.

The VLT® Motion Control Option MCO 305 is an integrated programmable motion controller that adds additional functionality and flexibility to the VLT® AutomationDrive.

With the Motion Control Option, the VLT® AutomationDrive becomes an intelligent drive with highly accurate, dynamic motion control, synchronization (electronic shaft), positioning and electronic CAM control.

In addition the option enables you to implement a variety of application functions, such as monitoring and intelligent error handling. Dedicated options are pre-programmed for specific tasks:

Dedicated options

- VLT® Synchronizing Controller MCO 350
- VLT® Positioning Controller MCO 351





Most popular fieldbuses supported

Increase productivity

With the wide range of fieldbus options the VLT® AutomationDrive can be easily connected to the fieldbus system of your choice. This makes the AutomationDrive a future-ready solution that can easily be expanded and updated if your needs change. See the complete list of fieldbuses on page 34.

Danfoss fieldbus options can also be installed as a plug-and-play solution at a later stage, if the production layout demands a new communication platform. This way, you can be confident that you can optimize your plant without being forced to replace your existing drive system.

Download drivers for easy PLC integration

Integrating a drive into an existing bus system can be time consuming and complicated. To make this process easy and more efficient, Danfoss provides all necessary fieldbus drivers and instructions, which can be downloaded for free from the Danfoss website.

After installation the bus parameters, typically only a few, can be set directly in the VLT® drive via the local control panel, the VLT® MCT 10 or the fieldbus itself.





Software tools

Easy engineering and setup with VLT® Motion Control Tool MCT 10

In addition to operating the drive via LCP (local control panel), VLT® drives can also be configured and monitored with Danfoss own PC software. This provides plant managers with a comprehensive overview of the system at any point in time, adding a new level of flexibility in configuration, monitoring and troubleshooting.

MCT 10 is a windows based engineering tool with a clearly structured interface that provides an instant overview of all the drives in a system of any size. The software runs under Windows and enables data exchange over a traditional RS485 interface, fieldbus (Profibus, Ethernet, etc.) or via USB.

Parameter configuration is possible both online on a connected drive and offline in the tool itself. Additional documentation, such as electrical diagrams or operating manuals, can be embedded in MCT 10. This reduces the risk of incorrect configuration while offering fast access to troubleshooting.

Analyse harmonic distortion with VLT® Harmonic Calculation Software HCS

This is an advanced simulation program that makes calculating harmonic distortion in your mains network fast and easy. It is the ideal solution both if you are planning to extend your

existing plant or installation or if you are planning a new installation from scratch.

The user-friendly interface allows you to configure the mains environment as desired and returns simulation results, which you can use to optimize your network.

Contact your local Danfoss sales office or visit our website for more information or visit directly at www.danfoss-hcs.com

VLT® Motion Control Tool MCT 31 Harmonics Calculation Software

VLT® MCT 31 calculates system harmonic distortion for both Danfoss and non-Danfoss drives. It is also able to calculate the effects of using

various additional harmonic reduction measures, including Danfoss harmonic filters.

With VLT® Motion Control Tool MCT 31, you can determine whether harmonics will be an issue in your installation, and if so, what strategies will be most cost-effective in addressing the problem.

VLT® Motion Control Tool MCT 31 features include:

- Short circuit current ratings can be used instead of transformer size and impedance when transformer data is unknown
- Project oriented for simplified calculations on several transformers
- Easy to compare different harmonic solutions within the same project
- Supports current Danfoss product line as well as legacy drive models

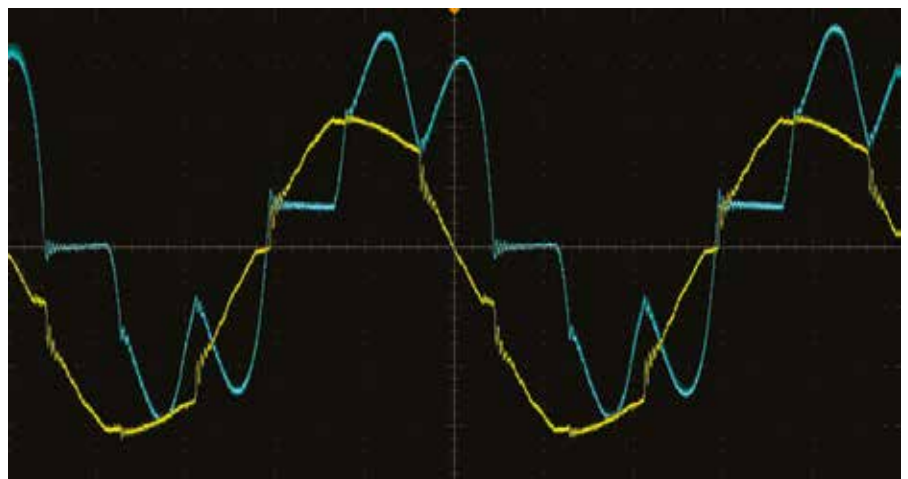



Intuitive setup with graphical interface



The VLT® AutomationDrive features a user-friendly, hot pluggable local control panel (LCP) for easy setup and parameter configuration.

After choosing language navigate through setup parameters individually. Alternatively, use a pre-defined quick menu or a StartSmart guide for application specific setup.

The LCP can be detached and used to copy settings to other AutomationDrives in the system. It can also be mounted remotely on a control panel fascia. This enables the user to take full advantage of the LCP, eliminating the need for additional switches and instrumentation.

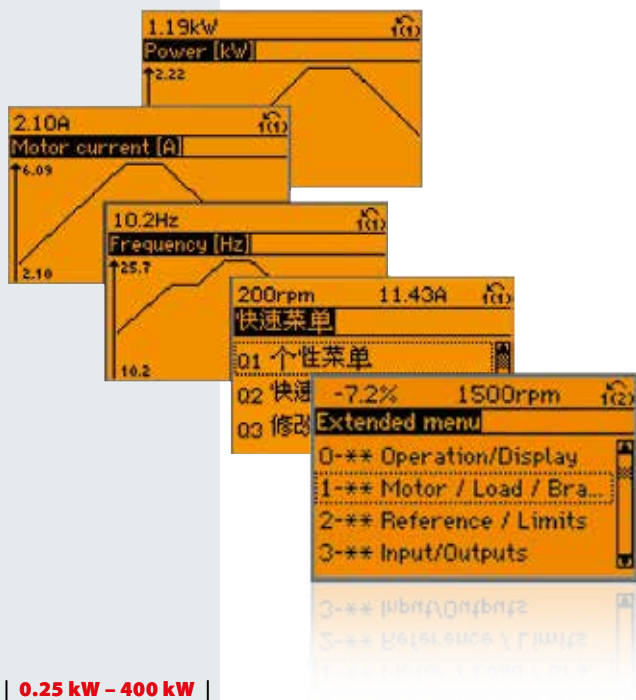



Save commissioning time with SmartStart

Using the graphical control panel SmartStart provides a quick, guided drive setup procedure that covers the most common applications. By guiding users through a number of steps, users avoid the potential confusion which may be encountered when accessing the entire parameter set. By only presenting information that is relevant, basic setup is fast and less prone to error.

- Conveyor: configuration of horizontal loads in e.g. assembly line, conveyors and material handling lines.
- Pump/fan: parameter setting of PID controller
- Mechanical brake control: configuration of vertical loads such as simple hoists with mechanical brake control.
- Fieldbus connection: automatically allows users to configure the fieldbus connection when a communication option is plugged in the drive and the application programming is finished.

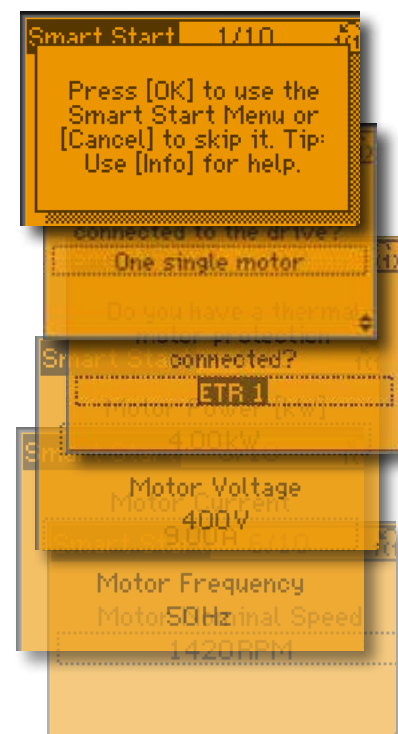

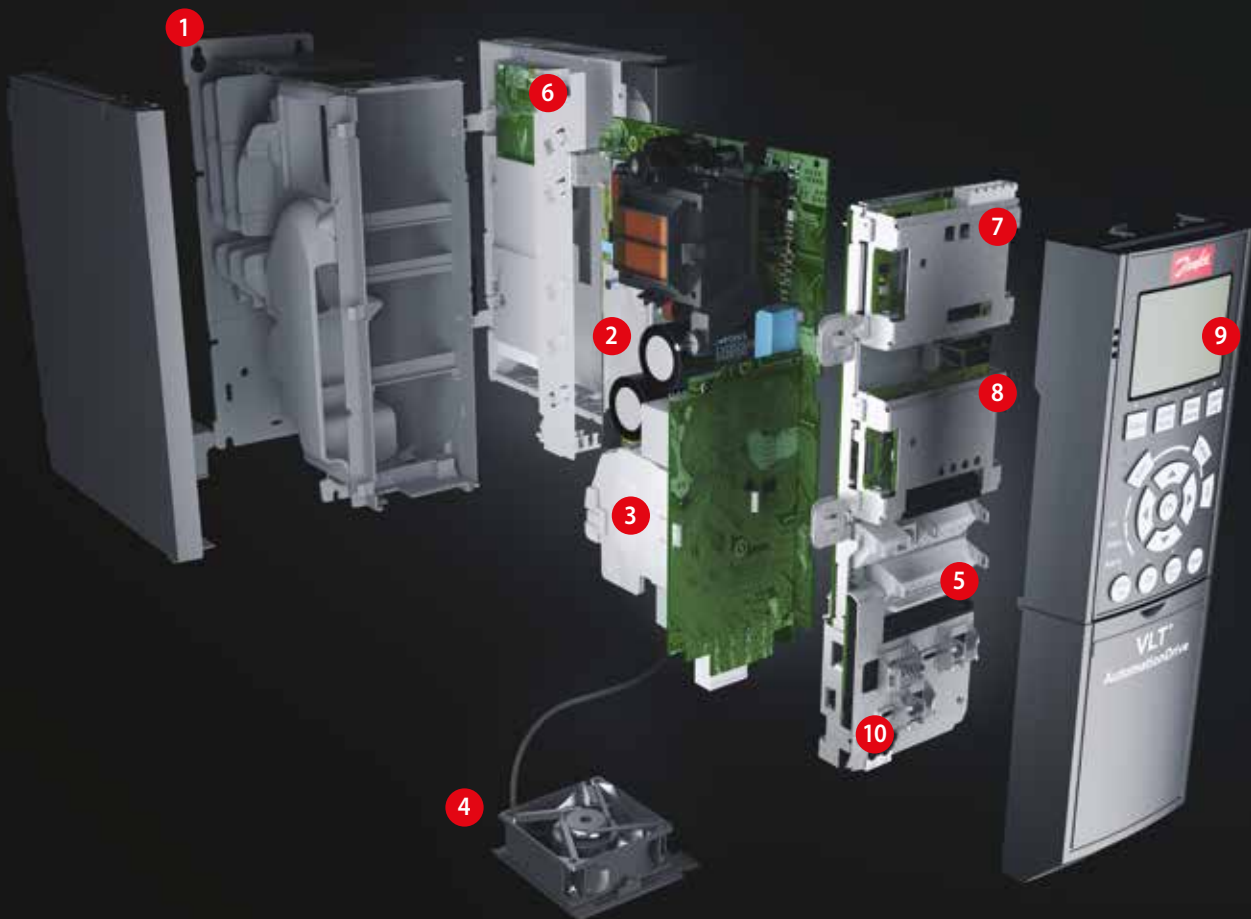

Modular simplicity

Delivered fully assembled and tested to meet your specific requirements

Two performance levels

Use the FC 301 version for standard needs and the FC 302 version for applications that need greater functionality and dynamic response.

1. Enclosure

The drive meets requirements for enclosure class IP 20/Chassis. IP 21/Type 1, IP 54/Type 12, IP 55/Type 12 or IP 66/Type 4X.

2. EMC and Network effects

All versions of VLT® AutomationDrive comply as standard with EMC limits B, A1 or A2 according to the EN 55011 norm. The standard integrated DC coils ensure low harmonic load on the network according to EN 61000-3-12 and increase the lifetime of the DC link capacitors.

3. Protective coating

All VLT® AutomationDrives conform to class 3C2 (IEC 60721-3-3). If used in especially harsh conditions it is possible to order a special coating that complies with class 3C3.

4. Removable fan

Like most of the elements, the fan can be quickly removed and remounted for easy cleaning.

5. Control terminals

Double-stack, spring-loaded cage clamps enhance reliability and facilitate easy commissioning and service.

6. Programmable options

A programmable Motion Controller MCO 305 adds functionality and flexibility to the already very comprehensive standard

functionality of the drive. Pre-programmed Motion Controllers for Synchronizing and Positioning are also available, ready for use (MCO 350 and MCO 351).

7. Fieldbus option

See complete list of available fieldbus options on page 34.

8. I/O extensions

A wide range of I/O options are available either factory-mounted or as retrofit.

9. Display option

Danfoss VLT Drives' removable Local Control Panel is available with a variety of language packs: East European, West European, Asian and North American.



English and German are available in all drives.

Alternatively the drive can be commissioned via the built-in USB/RS485 connection or a fieldbus from with VLT® Motion Control Tool MCT 10 setup software.

10. 24 V external power supply

The external 24 V supply keeps the VLT® AutomationDrive logic “alive” when the AC mains is removed.

11. Mains disconnect

This switch interrupts the mains supply and has a free useable auxiliary contact.

Safety

The FC 302 is delivered as standard with the Safe Torque Off (STO) function in compliance with ISO

13849-1 Category 3 PL d and SIL 2 according to IEC 61508 low demand and high demand mode. The safety functions can be extended to include SS1, SLS, SMS, SSM, safe jog mode etc. with the VLT® Safety Option MCB 140 Series and VLT® Safety Option MCB 150 Series.

Built-in Smart Logic Controller

The Smart Logic Controller is a clever way to add customer-specific functionality to the drive and increase the opportunities for the drive, motor and application working together.

The controller monitors a specified event. When an event occurs, the controller performs a pre-defined

action and then starts monitoring for the next pre-defined event. 20 steps of events and resulting actions are available before returning to the first set.

Logic functions can be selected and run independent from the sequence control. This enables drives to monitor variables or signal defined events in an easy and flexible way independently of the motor control.



The big picture

An investment that pays

Increase application performance and streamline processes with energy efficient, adaptive motor control. Combine reliable, high performing solutions from a single supplier to reduce the lifetime costs of your applications.

Minimize energy costs

As energy becomes increasingly expensive, variable speed control of electrical motors has proven to be one of the most effective cost-reducing measures available.

For example, by reducing the average speed of the motor from 100% to 80% in for example pumps or fans, 50% energy is saved. Reducing the average speed by 50% increases the savings to 80%.

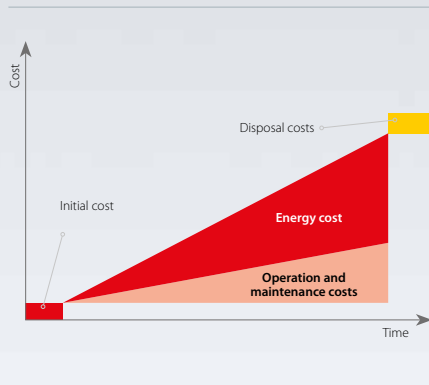

Reduce total cost of ownership

Seen over its lifetime, the initial cost of a drive only amounts to 10% of the total cost of ownership; the remaining 90% cover energy consumption, service and maintenance.

During setup Automatic Motor Adaptation (AMA) and later during operation Automatic Energy Optimization (AEO) ensure that the drive is perfectly adapted to the attached motor and changing loads.

Once in operation VLT® drives serve reliably for their entire lifetime. Only requiring minimal maintenance, the VLT® AutomationDrives provide a fast return on investment and ultimately a competitive cost of ownership.

Automatic Energy Optimization ensures that the motor voltage adapts automatically to changing loads. This provides an efficiency boost of up to 5-15%, reducing the cost of ownership substantially.

On the following pages we help you select the optimal VLT® for applications from 0.25 and 400 kW. For larger drives, please consult the selection guide for Danfoss VLT® High Power Drives.



Chose the adequate performance level

Special needs require special features and performance

	FC 301 (A1-frame)	FC 301	FC 302
Power range [kW] 200 – 240 V	0.25 – 1.5	0.25 – 37	0.25 – 37
Power range [kW] 380 – (480) 500 V	0.37 – 1.5	0.37 – 75 (480 V)	0.37 – 1000 (500 V)
Power range [kW] 525 – 600 V	–	–	0.75 – 75
Power range [kW] 525 – 690 V	–	–	1.1 – 1200
IP 20/21 (Type 1)	■	■	■
IP 54/IP 55 (Type 12)	–	■	■
IP 66/Type 4x	–	■	■
Ambient temperature °C w/o de-rating	50° C	50° C	up to 50° C
VVC+ vector control	■	■	■
U/f	■	■	■
Flux vector control	–	–	■
Cable length – screened/unscreened	25/50 m	50/75 m	150/300 m
Permanent magnet motor operation (w/wo feedback)	–	–	■
KTY-monitoring of temperature	■	■	■
Monitoring of over-voltage	■	■	■
Smart Logic Control	■	■	■
Safety function Safe Torque Off (STO – EN 61800-5-2)	Option	–	■
Galvanic isolation PELV	■	■	■
Conformal coated PCBs (IEC 60721-3-3), 3C2	Standard	Standard	Standard
Removable fan	■	■	■
RS 485 and USB-interface	■	■	■
Modbus RTU	■	■	■
FC Protocol	■	■	■
Graphical/numerical control panel (LCP 102/101)	Option	Option	Option
Scan interval/response time ms	5	5	1
Output frequency (OL)	0.2 to 590 Hz	0.2 to 590 Hz	0 to 590 Hz*
Max load (24 V DC) for analogue output and Control card [mA]	130	130	200
Pluggable control terminals	■	■	■
Analogue input (changeable)	0 ... +10 V/4...20 mA	0 ... +10 V/4...20 mA	0 ... ±10 V/4...20 mA
Analogue output resolution	12 bit	12 bit	12 bit
Programmable digital input	5 (4)	5 (4)	6 (4)
Programmable digital output changeable	1	1	2
Programmable Relay Output	1	1	2
Process PID control	■	■	■
Flying start – catch spinning motor	■	■	■
Automatic Energy Optimization (AEO)	■	■	■
Precise Start/Stop	■	■	■
Number of fixed parameter sets	4	4	4
Digital motor potentiometer	■	■	■
Integrated motor database	■	■	■
Kinetic back-up	■	■	■

* For frequency up to 1000 Hz please contact your local Danfoss partner.

Specifications

Basic unit without extensions

Main supply (L1, L2, L3)	FC 301	FC 302
Supply voltage	200 – 240 V ±10%	
	380 – 480 V ±10%	380 – 500 V ±10%
		525 – 600 V ±10%
		525 – 690 V ±10%
Supply frequency	50/60 Hz +/- 5%	
Displacement power factor (cos φ)	> 0.98 near unity	
Harmonic disturbance	Meets EN 61000-3-12	

Output data (U, V, W)	FC 301	FC 302
Output voltage	0 – 100% of supply voltage	
Output frequency	0.2-590 Hz	0-590 Hz
Switching on output	Unlimited	
Ramp times	0.01-3600 sec.	

Digital inputs	FC 301	FC 302
Programmable digital inputs	4 (5) ¹⁾	4 (6) ¹⁾
Changeable to digital output	1 (terminal 27)	2 (terminal 27, 29)
Logic	PNP or NPN	
Voltage level	0 – 24 V DC	
Maximum voltage on input	28 V DC	
Input resistance, Ri	Approx. 4 kΩ	
Scan interval	5 ms	1 ms

Analogue inputs	FC 301	FC 302
Analogue inputs	2	
Modes	Voltage or current	
Voltage level	0 to +10 V (scaleable)	-10 to +10 V (scaleable)
Current level	0/4 to 20 mA (scaleable)	
Accuracy of analogue inputs	Max. error: 0.5% of full scale	

Pulse/encoder inputs	FC 301	FC 302
Programmable pulse/encoder inputs	2/1	
Voltage level	0 – 24 V DC (PNP positive logic)	
Pulse input accuracy (0.1 - 1 kHz)	Max. error: 0.1% of full scale	
Encoder input accuracy (1 – 110 kHz)	Max. error: 0.05% of full scale enter 32 (A), 33 (B) and 18 (Z)	

Digital output	FC 301	FC 302
Programmable digital/pulse outputs	1	2
Voltage level at digital/frequency output	0 – 24 V DC	
Max. output current (sink or source)	40 mA	
Maximum output frequency at frequency output	0 to 32 kHz	
Accuracy on frequency output	Max. error: 0.1% of full scale	

Analogue output	FC 301	FC 302
Programmable analogue outputs	1	
Current range at analogue output	0/4 – 20 mA	
Max. load to common at analogue output (clamp 30)	500 Ω	
Accuracy on analogue output	Max. error: 1% of full scale	

Control card	FC 301	FC 302
USB interface	1.1 (Full Speed)	
USB plug	Type "B"	
RS485 interface	Up to 115 kBaud	
Modbus RTU		
Max. load (10 V)	15 mA	
Max. load (24 V)	130 mA	200 mA

Relay output	FC 301	FC 302
Programmable relay outputs	1	2
Max. terminal load (AC) on 1-3 (break), 1-2 (make), 4-6 (break) power card	240 V AC, 2 A	
Max. terminal load (AC) on 4-5 (make) power card	400 V AC, 2 A	
Min. terminal load on 1-3 (break), 1-2 (make), 4-6 (break), 4-5 (make) power card	24 V DC 10 mA, 24 V AC 20 mA	

Surroundings/external	FC 301	FC 302
Enclosure	IP 00, IP 20, IP 21, IP 54, IP 55, IP 66	
Vibration test	1.0 g (D-enclosure: 0.7 g)	
Max. relative humidity	5% – 95% (IEC 60721-3-3; Class 3C3 (non-condensing) during operation)	
Aggressive environment (IEC 60721-3-3)	Standard coated PCB Class 3C2, optional coated class 3C3	
Ambient temperature	Max. 50° C without derating (higher temperatures possible with derating)	
Galvanic isolation of all	I/O supplies according to PELV	

Protection mode for longest possible up-time
Electronic thermal motor protection against overload
Temperature monitoring of the heat sink ensures that the FC 300 cuts out if the temperature reaches 100 °C
The FC 300 is protected against short-circuits and earth fault on motor terminals U, V, W
Protection against mains phase loss

1) Terminals 27 and 29 can also be programmed as output.



Global Marine

Connection examples

The numbers represent the terminals on the drive

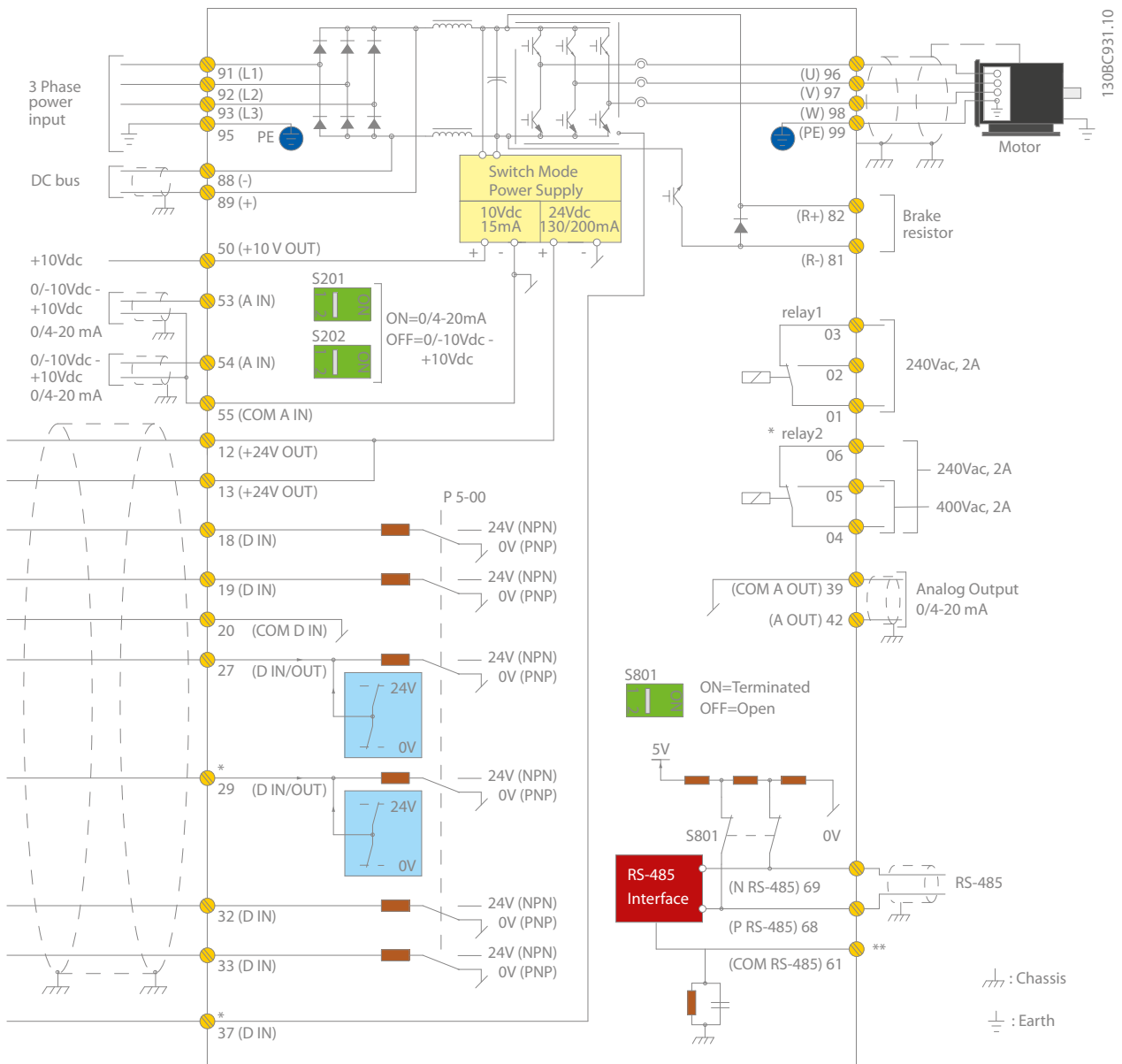

The diagram shows the terminals of the FC 301 and FC 302. Additional options will expand the number of terminals.

Brake chopper (terminals 81 and 82) and load sharing (terminals 88 and 89) must be specified when configuring/ordering.

All FC 301/302 have an RS485, a USB and a Modbus RTU interface as standard.

The drive can be equipped with a fieldbus option if necessary.

Diagram showing all electrical terminals without options.

A = analog, D = digital
Terminal 37 is used for Safe Stop. For instructions on Safe Stop installation please refer to the section Safe Stop Installation of the Design Guide.

*Terminal 37 is not included in VLT® AutomationDrive FC 301 (Except VLT® AutomationDrive FC 301 A1, which includes Safe Stop).

Relay 2 and Terminal 29, have no function in VLT® AutomationDrive FC 301.

** Do not connect cable screen

VLT® AutomationDrive 200-240 V AC

Enclosure	IP 20	A1						A3		
		A2						A3		
	IP 20 (IP 21)	PK25	PK37	PK55	PK75	P1K1	P1K5	P2K2	P3K0	P3K7
Typical shaft output	[kW]	0.25	0.37	0.55	0.75	1.1	1.5	2.2	3	3.7
Output current										
Continuous	[A]	1.8	2.4	3.5	4.6	6.6	7.5	10.6	12.5	16.7
Intermittent	[A]	2.9	3.8	5.6	7.4	10.6	12.0	17.0	20.0	26.7
Output power										
Continuous (208 V)	[kVA]	0.65	0.86	1.26	1.66	2.38	2.70	3.82	4.50	6.00
Rated input current										
Continuous	[A]	1.6	2.2	3.2	4.1	5.9	6.8	9.5	11.3	15.0
Intermittent	[A]	2.6	3.5	5.1	6.6	9.4	10.9	15.2	18.1	24.0
Estimated power loss at rated maximum load	[W]	21	29	42	54	63	82	116	155	185
Efficiency		0.94			0.95			0.96		
Max. cable cross-section*	[mm ²] ([AWG])	4 (12)								
Max. external input (mains) fuses	[A]	10			20			32		
Weight										
IP 20 (A1)	[kg]				2.7			-		
IP 20 (A2/A3)	[kg]	4.7		4.8		4.9			6.6	
IP 55, IP 66 (A5)	[kg]	13.5								

Enclosure	IP 20	B3				B4	
		B1				B2	
	IP 21, IP 55, IP 66	P5K5		P7K5		P11K	
	Overload	HO	NO	HO	NO	HO	NO
Typical shaft output	[kW]	5.5	7.5		11		15
Output current							
Continuous	[A]	24.2	30.8		46.2		59.4
Intermittent	[A]	38.7	33.9		49.3		65.3
Output power							
Continuous (208 V)	[kVA]	8.7	11.1		16.6		21.4
Rated input current							
Continuous	[A]	22	28		42		54
Intermittent	[A]	35.2	30.8		44.8		59.4
Estimated power loss at rated maximum load	[W]	239	310		371		602
Efficiency		0.96					
Max. cable cross-section*	[mm ²] ([AWG])	16 (6)				35 (2)	
Max. external input (mains) fuses	[A]	63				80	
Weight							
IP 20	[kg]	12				23.5	
IP 21, IP 55, IP 66	[kg]	23				27	

Enclosure	IP 20	B4		C3				C4				
		C1		C2								
	IP 21, IP 55, IP 66	P15K		P18K5		P22K		P30K		P37K		
	Overload	HO	NO	HO	NO	HO	NO	HO	NO	HO	NO	
Typical shaft output	[kW]	15	18.5		22		30		37		45	
Output current												
Continuous	[A]	59.4	74.8		88		115		143		170	
Intermittent	[A]	89.1	82.3		112		127		157		187	
Output power												
Continuous (208 V)	[kVA]	21.4	26.9		31.7		41.4		51.5		61.2	
Rated input current												
Continuous	[A]	54	68		80		104		130		154	
Intermittent	[A]	81	74.8		102		114		143		169	
Estimated power loss at rated maximum load	[W]	624	737		740		874		1143		1636	
Efficiency		0.96			0.97							
Max. cable cross-section IP 20*	[mm ²] ([AWG])	35 (2)		50 (1)				120 (300 MCM)				
Max. cable cross-section IP 21, IP 55, IP 66*	[mm ²] ([AWG])	90 (3/0)						120 (4/0)				
Max. external input (mains) fuses	[A]	125			160		200		250			
Weight												
IP 20	[kg]	23.5		35				50				
IP 21, IP 55, IP 66	[kg]	45			65							

HO (High overload) = up to 160%/60 s, NO (Normal overload) = 110%/60 s

*Max. cable cross-section: input mains terminals, motor output terminals, brake resistor terminals, DC Link

VLT® AutomationDrive 380-480/500 V AC

Enclosure		IP 20		A1						A2		A3	
		IP 20 (IP 21)		A2						A3			
		IP 55, IP 66		A4 + A5						A5			
				PK37	PK55	PK75	P1K1	P1K5	P2K2	P3K0	P4K0	P5K5	P7K5
Typical shaft output	[kW]	0.37	0.55	0.75	1.1	1.5	2.2	3	4	5.5	7.5		
Output current													
Continuous (380-440 V)	[A]	1.3	1.8	2.4	3	4.1	5.6	7.2	10	13	16		
Intermittent (380-440 V)	[A]	2.1	2.9	3.8	4.8	6.6	9.0	11.5	16	20.8	25.6		
Continuous (441-480/500 V)	[A]	1.2	1.6	2.1	2.7	3.4	4.8	6.3	8.2	11	14.5		
Intermittent (441-480/500 V)	[A]	1.9	2.6	3.4	4.3	5.4	7.7	10.1	13.1	17.6	23.2		
Output power													
400 V	[kVA]	0.9	1.3	1.7	2.1	2.8	3.9	5.0	6.9	9.0	11.0		
460 V	[kVA]	0.9	1.3	1.7	2.4	2.7	3.8	5.0	6.5	8.8	11.6		
Rated input current													
Continuous (380-440 V)	[A]	1.2	1.6	2.2	2.7	3.7	5.0	6.5	9.0	11.7	14.4		
Intermittent (380-440 V)	[A]	1.9	2.6	3.5	4.3	5.9	8.0	10.4	14.4	18.7	23.0		
Continuous (441-480/500 V)	[A]	1.0	1.4	1.9	2.7	3.1	4.3	5.7	7.4	9.9	13.0		
Intermittent (441-480/500 V)	[A]	1.6	2.2	3.0	4.3	5.0	6.9	9.1	11.8	15.8	20.8		
Estimated power loss at rated maximum load	[W]	35	42	46	58	62	88	116	124	187	255		
Efficiency		0.93	0.95	0.96			0.97						
Max. cable cross-section*	[mm ²] ([AWG])	4 (12)											
Max. external input (mains) fuses	[A]	10					20			32			
Weight													
IP 20	[kg]	4.7			4.8				6.6				
IP 55, IP 66	[kg]	13.5					14.2						

Enclosure		IP 20		B3				B4			
		IP 21, IP 55, IP 66		B1				B2			
		Overload		P11K		P15K		P18K		P22K	
				HO	NO	HO	NO	HO	NO	HO	NO
Typical shaft output	[kW]	11	15	18.5		22.0		30.0			
Output current											
Continuous (380-440 V)	[A]	24	32	37.5		44		61			
Intermittent (380-440 V)	[A]	38.4	35.2	51.2	41.3	60	48.4	70.4	67.1		
Continuous (441-480/500 V)	[A]	21	27	34		40		52			
Intermittent (441-480/500 V)	[A]	33.6	29.7	43.2	37.4	54.4	44	64	57.2		
Output power											
400 V	[kVA]	16.6	22.2	26		30.5		42.3			
460 V	[kVA]	21.5		27.1		31.9		41.4			
Rated input current											
Continuous (380-440 V)	[A]	22	29	34		40		55			
Intermittent (380-440 V)	[A]	35.2	31.9	46.4	37.4	54.4	44	64	60.5		
Continuous (441-480/500 V)	[A]	19	25	31		36		47			
Intermittent (441-480/500 V)	[A]	30.4	27.5	40	34.1	49.6	39.6	57.6	51.7		
Estimated power loss at rated maximum load	[W]	291	392	379	465	444	525	547	739		
Efficiency		0.98									
Max. cable cross-section*	[mm ²] ([AWG])	16 (6)				35 (2)					
Max. external input (mains) fuses	[A]	63						80			
Weight											
IP 20	[kg]	12				23.5					
IP 21, IP 55, IP 66	[kg]	23				27					

HO (High overload) = up to 160%/60 s, NO (Normal overload) = 110%/60 s

*Max. cable cross-section: input mains terminals, motor output terminals, brake resistor terminals, DC Link

VLT® AutomationDrive 380-480/500 V AC

Enclosure	IP 20	B4		C3				C4				
		IP 21, IP 55, IP 66		C1						C2		
	Overload	HO	NO	HO	NO	HO	NO	HO	NO	HO	NO	
Typical shaft output	[kW]	30	37	45		55		75		90		
Output current												
Continuous (380-440 V)	[A]	61	73	90		106		147		177		
Intermittent (380-440 V)	[A]	91.5	80.3	110	99	135	117	159	162	221	195	
Continuous (441-480/500 V)	[A]	52	65	80		105		130		160		
Intermittent (441-480/500 V)	[A]	78	71.5	97.5	88	120	116	158	143	195	176	
Output power												
400 V	[kVA]	42.3	50.6	62.4		73.4		102		123		
460 V	[kVA]	51.8		63.7		83.7		104		128		
Rated input current												
Continuous (380-440 V)	[A]	55	66	82		96		133		161		
Intermittent (380-440 V)	[A]	82.5	72.6	99	90.2	123	106	144	146	200	177	
Continuous (441-480/500 V)	[A]	47	59	73		95		118		145		
Intermittent (441-480/500 V)	[A]	70.5	64.9	88.5	80.3	110	105	143	130	177	160	
Estimated power loss at rated maximum load	[W]	570	698	697	843	891	1083	1022	1384	1232	1474	
Efficiency		0.98						0.99				
Max. cable cross-section IP 20*	[mm ²] ([AWG])	35 (2)		50 (1)				95 (4/0)		150 (300 MCM)		
Max. cable cross-section IP 21, IP 55, IP 66	[mm ²] ([AWG])	90 (3/0)						120 (4/0)				
Max. external input (mains) fuses	[A]	100		125		160		250				
Weight												
IP 20	[kg]	23.5		35				50				
IP 21, IP 55, IP 66	[kg]	45				65						

VLT® AutomationDrive 3 x 380-500 V AC

Enclosure	IP 20	D3h						D4h						
		IP 21, IP 55		D1h + D5h + D6h						D2h + D7h + D8h				
	Overload	HO	NO	HO	NO	HO	NO	HO	NO	HO	NO	HO	NO	
Typical shaft output (400 V)	[kW]	90	110	132		160		200		250		315		
Typical shaft output (460 V)	[HP]	125	150	200		250		300		350		450		
Typical shaft output (500 V)	[kW]	110	132	160		200		250		315		355		
Output current														
Continuous (400 V)	[A]	177	212	260		315		395		480		588		
Intermittent (400 V)	[A]	266	233	318	286	390	347	473	435	593	528	720	647	
Continuous (460/500 V)	[A]	160	190	240		302		361		443		535		
Intermittent (460/500 V)	[A]	240	209	285	264	360	332	453	397	542	487	665	588	
Output power														
Continuous (400 V)	[kVA]	123	147	180		218		274		333		407		
Continuous (460 V)	[kVA]	127	151	191		241		288		353		426		
Continuous (500 V)	[kVA]	139	165	208		262		313		384		463		
Rated input current														
Continuous (400 V)	[A]	171	204	251		304		381		463		567		
Continuous (460/500 V)	[A]	154	183	231		291		348		427		516		
Estimated power loss at rated maximum load at 400 V	[W]	2031	2559	2289	2954	2923	3770	3093	4116	4039	5137	5005	6674	
Estimated power loss at rated maximum load at 460 V	[W]	1828	2261	2051	2724	2089	3628	2872	3569	3575	4566	4458	5714	
Efficiency		0.98												
Max. cable size Mains, motor, brake and loadsharing	[mm ²] ([AWG])	2 x 95 (2 x 3/0)						2 x 185 (2 x 350 mcm)						
Max. external input (mains) fuses	[A]	315		350		400		550		630		800		
Weight														
IP 20, IP 21, IP 54	[kg]	62 (D1h + D3h) 166 (D5h), 129 (D6h)						125 (D2h + D4h) 200 (D7h), 225 (D8h)						

HO (High overload) = up to 160%/60 s, NO (Normal overload) = 110%/60 s

*Max. cable cross-section: input mains terminals, motor output terminals, brake resistor terminals, DC Link

VLT® AutomationDrive 525-600 V AC (FC 302 only)

Enclosure	IP 20 (IP 21)	A3							
	IP 55, IP 66	A5							
		PK75	P1K1	P1K5	P2K2	P3K0	P4K0	P5K5	P7K5
Typical shaft output (575 V)	[kW]	0.75	1.1	1.5	2.2	3	4	5.5	7.5
Output current									
Continuous (525-550 V)	[A]	1.8	2.6	2.9	4.1	5.2	6.4	9.5	11.5
Intermittent (525-550 V)	[A]	2.9	4.2	4.6	6.6	8.3	10.2	15.2	18.4
Continuous (551-600 V)	[A]	1.7	2.4	2.7	3.9	4.9	6.1	9.0	11.0
Intermittent (551-600 V)	[A]	2.7	3.8	4.3	6.2	7.8	9.8	14.4	17.6
Output power									
Continuous (525 V)	[kVA]	1.7	2.5	2.8	3.9	5.0	6.1	9.0	11.0
Continuous (575 V)	[kVA]	1.7	2.4	2.7	3.9	4.9	6.1	9.0	11.0
Estimated power loss at rated maximum load	[W]	35	50	65	92	122	145	195	261
Rated input current									
Continuous (525-600 V)	[A]	1.7	2.4	2.7	4.1	5.2	5.8	8.6	10.4
Intermittent (525-600 V)	[A]	2.7	3.8	4.3	6.6	8.3	9.3	13.8	16.6
Efficiency		0.97							
Max. cable cross-section*	[mm ²] ([AWG])	4 (12)							
Max. external input (mains) fuses	[A]	10			20			32	
Weight									
IP 20	[kg]	6.5			6.6				
IP 55, IP 66	[kg]	13.5			14.2				

Enclosure	IP 20	B3				B4					
	IP 21, IP 55, IP 66	B1				B2				C1	
		P11K		P15K		P18K5		P22K		P30K	
	Overload	HO	NO	HO	NO	HO	NO	HO	NO	HO	NO
Typical shaft output (575 V)	[kW]	11	15	18.5		22		30		37	
Output current											
Continuous (525-550 V)	[A]	19	23	28		36		43		54	
Intermittent (525-550 V)	[A]	30	25	37	31	45	40	58	47	65	59
Continuous (551-600 V)	[A]	18	22	27		34		41		52	
Intermittent (551-600 V)	[A]	29	24	35	30	43	37	54	45	62	57
Output power											
Continuous (500 V)	[kVA]	18.1	21.9	26.7		34.3		41.0		51.4	
Continuous (575 V)	[kVA]	17.9	21.9	26.9		33.9		40.8		51.8	
Rated input current											
Continuous 550 V	[A]	17.2	20.9	25.4		32.7		39		49	
Intermittent (550 V)	[A]	28	23	33	28	41	36	52	43	59	54
Continuous (575 V)	[A]	16	20	24		31		37		47	
Intermittent (575 V)	[A]	26	22	32	27	39	34	50	41	56	52
Estimated power loss at rated maximum load	[W]	225		285		329		700		700	
Efficiency		0.98									
Max. cable cross-section IP 20*	[mm ²] ([AWG])	16 (6)				35 (2)					
Max. cable cross-section IP 21, IP 55, IP 66*	[mm ²] ([AWG])	16 (6)				35 (2)				50 (1)	
Max. external input (mains) fuses	[A]	63		63		63		80		100	
Weight											
IP 20	[kg]	12				23.5					
IP 21, IP 55, IP 66	[kg]	23				27					

HO (High overload) = up to 160%/60 s, NO (Normal overload) = 110%/60 s

*Max. cable cross-section: input mains terminals, motor output terminals, brake resistor terminals, DC Link

VLT® AutomationDrive 525-600 V AC (FC 302 only)

Enclosure	IP 21, IP 55, IP 66		C1				C2			
	IP 20		C3				C4			
			P37K		P45K		P55K		P75K	
	Overload	HO	NO	HO	NO	HO	NO	HO	NO	
Typical shaft output (575 V)	[kW]	37	45		55		75		90	
Output current										
Continuous (525-550 V)	[A]	54	65		87		105		137	
Intermittent (525-550 V)	[A]	81	72	98	96	131	116	158	151	
Continuous (525-600 V)	[A]	52	62		83		100		131	
Intermittent (525-600 V)	[A]	78	68	93	91	125	110	150	144	
Output power										
Continuous (550 V)		51.4	61.9		82.9		100		130.5	
Continuous (575 V)	[kVA]	51.8	61.7		82.7		99.6		130.5	
Rated input current										
Continuous (550 V)	[A]	49	59		78.9		95.3		124.3	
Intermittent (550 V)	[A]	74	65	89	87	118	105	143	137	
Continuous (575 V)	[A]	47	56		75		91		119	
Intermittent (575 V)	[A]	70	62	85	83	113	100	137	131	
Estimated power loss at rated maximum load	[W]	850		1100		1400		1500		
Efficiency		0.98								
Max. cable cross-section IP 20*	[mm ²] ([AWG])	50 (1)				95 (4/0)		150 (300 MCM)		
						95 (4/0)				
Max. cable cross-section IP 21, 55, 66*	[mm ²] ([AWG])	90 (3/0)						120 (4/0)		
Max. external input (mains) fuses	[A]	125		160		250				
Weight										
IP 20	[kg]	35						50		
IP 21, IP 55, IP 66	[kg]	45						65		

HO (High overload) = up to 160%/60 s, NO (Normal overload) = 110%/60 s

*Max. cable cross-section: input mains terminals, motor output terminals, brake resistor terminals, DC Link

VLT® AutomationDrive 690 V AC (FC 302 only)

Enclosure	IP 20	A3						
		P1K1	P1K5	P2K2	P3K0	P4K0	P5K5	P7K5
Typical shaft output (690 V)	[kW]	1.1	1.5	2.2	3	4	5.5	7.5
Output current								
Continuous (525-550 V)	[A]	2.1	2.7	3.9	4.9	6.1	9	11
Intermittent (525-550 V)	[A]	3.4	4.3	6.2	7.8	9.8	14.4	17.6
Continuous (551-690 V)	[A]	1.6	2.2	3.2	4.5	5.5	7.5	10
Intermittent (551-690 V)	[A]	2.6	3.5	5.1	7.2	8.8	12	16
Output power								
Continuous (525 V)	[kVA]	1.9	2.5	3.5	4.5	5.5	8.2	10
Continuous (690 V)	[kVA]	1.9	2.6	3.8	5.4	6.6	9	12
Estimated power loss at rated maximum load	[W]	44	60	88	120	160	220	300
Rated input current								
Continuous (525-550 V)	[A]	1.9	2.4	3.5	4.4	5.5	8	10
Intermittent (525-550 V)	[A]	3.0	3.9	5.6	7.1	8.8	13	16
Continuous (551-690 V)	[A]	1.4	2.0	2.9	4.0	4.9	6.7	9
Intermittent (551-690 V)	[A]	2.3	3.2	4.6	6.5	7.9	10.8	14.4
Efficiency		0.96						
Max. cable cross-section IP 20*	[mm ²] ([AWG])	4 (12)						
Max. external input (mains) fuses	[A]	25						
Weight								
IP 20	[kg]	6.6						

Enclosure	IP 20 IP 21/IP 55	B4								C3				C2					
		P11K		P15K		P18K5		P22K		P30K		P37K		P45K		P55K		P75K	
		HO	NO	HO	NO	HO	NO	HO	NO	HO	NO	HO	NO	HO	NO	HO	NO	HO	NO
Typical shaft output (690 V)	[kW]	11	15	18.5	22	30	37	45	55	75	90								
Output current																			
Continuous (525-550 V)	[A]	14	19	23	28	36	43	54	65	87	105								
Intermittent (525-550 V)	[A]	22.4	20.9	30.4	25.3	36.8	30.8	44.8	39.6	54	47.3	64.5	59.4	81	71.5	97.5	95.7	130.5	115.5
Continuous (551-690 V)	[A]	13	18	22	27	34	41	52	62	83	100								
Intermittent (551-690 V)	[A]	20.8	19.8	28.8	24.2	35.2	29.7	43.2	37.4	51	45.1	61.5	57.2	78	68.2	93	91.3	124.5	110
Output power																			
Continuous (550 V)	[kVA]	13.3	18.1	21.9	26.7	34.3	41.0	51.4	61.9	82.9	100								
Continuous (575 V)	[kVA]	12.9	17.9	21.9	26.9	33.9	40.8	51.8	61.7	82.7	99.6								
Continuous (690 V)	[kVA]	15.5	21.5	26.3	32.3	40.6	49.0	62.1	74.1	99.2	119.5								
Rated input current																			
Continuous (525-690 V)	[A]	15	19.5	24	29	36	49	59	71	87	99								
Intermittent (525-690 V)	[A]	23.2	21.5	31.2	26.4	38.4	31.9	46.4	39.6	54	53.9	72	64.9	87	78.1	105	95.7	129	108.9
Estimated power loss at rated maximum load	[W]	228	285	335	375	480	592	720	880	1200									
Efficiency		0.98																	
Max. cable cross-section*	[mm ²] ([AWG])	35 (2)																	
Max. external input (mains) fuses	[A]	63					80	100	125	160									
Weight																			
IP 20,	[kg]	21.5 (B4)					35 (C3)				-								
IP 21, IP 55	[kg]	27 (B2)					65 (C2)												

HO (High overload) = up to 160%/60 s, NO (Normal overload) = 110%/60 s
 *Max. cable cross-section: mains, motor, brake and load share

VLT® AutomationDrive 3 x 525-690 V AC (FC 302 only)

Enclosure	IP 20		D3h										D4h							
	IP 21, IP 55		D1h + D5h + D6h										D2h + D7h + D8h							
	Overload		N55K		N75K		N90K		N110		N132		N160		N200		N250		N315	
		HO	NO	HO	NO	HO	NO	HO	NO	HO	NO	HO	NO	HO	NO	HO	NO	HO	NO	
Typical shaft output (550 V)	[kW]	45	55	75	90	110	132	160	200	250	315	315	400	400	400	400	400	400	400	400
Typical shaft output (575 V)	[HP]	60	75	100	125	150	200	250	300	350	400	400	400	400	400	400	400	400	400	400
Typical shaft output (690 V)	[kW]	55	75	90	110	132	160	200	250	315	400	400	400	400	400	400	400	400	400	400
Output current																				
Continuous (550 V)	[A]	76	90	113	137	162	201	253	303	360	418	418	418	418	418	418	418	418	418	418
Intermittent (550 V)	[A]	122	99	135	124	170	151	206	178	243	221	302	278	380	333	455	396	540	460	460
Continuous (575/690 V)	[A]	73	86	108	131	155	192	242	290	344	400	400	400	400	400	400	400	400	400	400
Intermittent (575/690 V)	[A]	117	95	129	119	162	144	197	171	233	211	288	266	363	319	435	378	516	440	440
Output power																				
Continuous (550 V)	[kVA]	72	86	108	131	154	191	241	289	343	398	398	398	398	398	398	398	398	398	398
Continuous (575 V)	[kVA]	73	86	108	130	154	191	241	289	343	398	398	398	398	398	398	398	398	398	398
Continuous (690 V)	[kVA]	87	103	129	157	185	229	289	347	411	478	478	478	478	478	478	478	478	478	478
Rated input current																				
Continuous (550 V)	[A]	77	87	110	130	158	198	245	299	355	408	408	408	408	408	408	408	408	408	408
Continuous (575 V)	[A]	77	89	106	124	151	189	234	286	339	390	390	390	390	390	390	390	390	390	390
Continuous (690 V)	[A]	77	87	109	128	155	197	240	296	352	400	400	400	400	400	400	400	400	400	400
Estimated power loss at rated maximum load at 575 V	[W]	1098	1162	1428	1430	1740	1742	2101	2080	2649	2361	3074	3012	3723	3642	4465	4146	5028	5028	5028
Estimated power loss at rated maximum load at 690 V	[W]	1057	1204	1205	1477	1480	1798	1800	2167	2159	2740	2446	3175	3123	3851	3771	4616	4258	5155	5155
Efficiency		0.98																		
Max. cable size Mains, motor, brake and loadsharing	[mm ²] ([AWG])	2 x 95 (2 x 3/0)										2 x 185 (2 x 350 mcm)								
Max. external input (mains) fuses	[A]	160	200			250			315			550								
Weight																				
IP 20, IP 21, IP 54	[kg]	62 (D1h + D3h) 166 (D5h), 129 (D6h)										125 (D2h + D4h) 200 (D7h), 225 (D8h)								

Dimensions and air flow



A1 IP 20

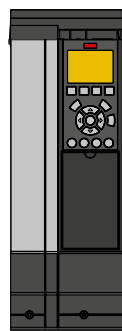
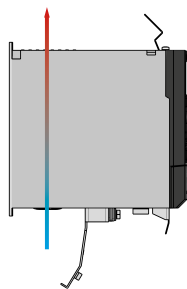

A3 with IP 21/Type 12 NEMA 1 Kit

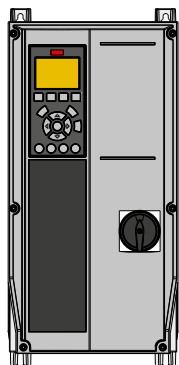
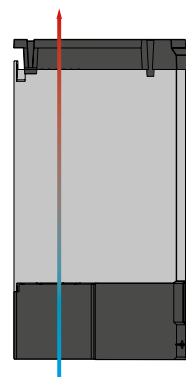

A4 IP 55 with mains disconnect

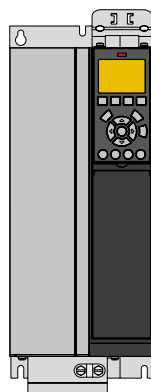
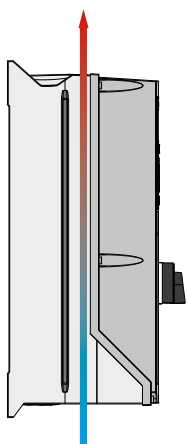

B3 IP 20

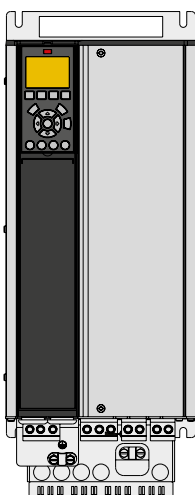
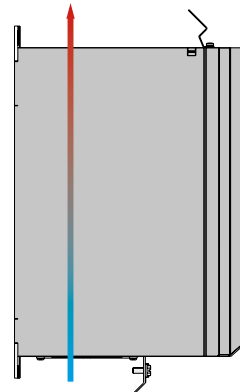

B4 IP 20

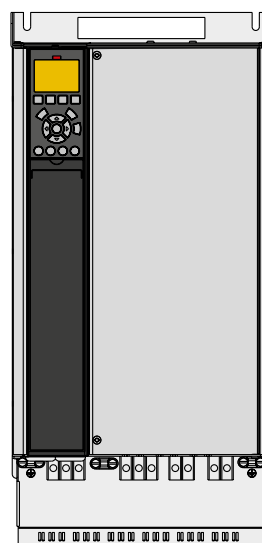
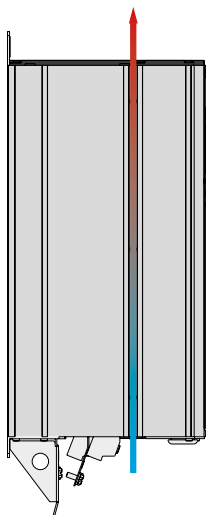

C3 IP 20

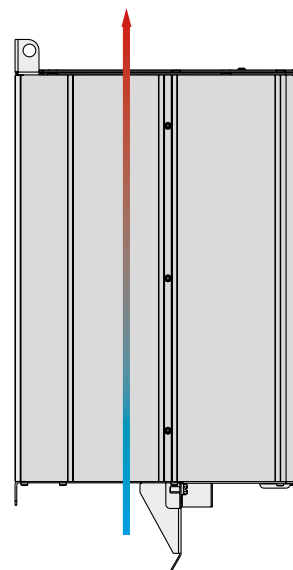

Please see the VLT® AutomationDrive FC 102 Design Guide for other frames, available at <http://www.danfoss.com/Products/Literature/VLT+Technical+Documentation.htm>

A, B and C frames

Frame	VLT® AutomationDrive														
	A1	A2		A3		A4	A5	B1	B2	B3	B4	C1	C2	C3	C4
Enclosure	IP 20	IP 20	IP 21	IP 20	IP 21	IP 55/IP 66		IP 21/IP 55/ IP 66		IP 20		IP 21/IP 55/ IP 66		IP 20	
H mm Height of back plate	200	268	375	268	375	390	420	480	650	399	520	680	770	550	660
H1 mm With de-coupling plate for fieldbus cables	316	374	–	374	–	–	–	–	–	420	595	–	–	630	800
H2 mm Distance to mounting holes	190	254	350	257	350	401	402	454	624	380	495	648	739	521	631
W mm	75	90	90	130	130	200	242	242	242	165	230	308	370	308	370
W1 mm With one C option	–	130	130	170	170	–	242	242	242	205	230	308	370	308	370
W2 mm With two C options	–	150	150	190	190	–	242	242	242	225	230	308	370	308	370
W3 mm Distance between mounting holes	60	70	70	110	110	171	215	210	210	140	200	272	334	270	330
D mm Depth without option A/B	207	205	207	205	207	175	195	260	260	249	242	310	335	333	333
D1 mm With mains disconnect	–	–	–	–	–	206	224	289	290	–	–	344	378	–	–
D2 mm With option A/B	222	220	222	220	222	175	195	260	260	262	242	310	335	333	333
Air cooling	I (air space inlet) mm	100	100	100	100	100	100	200	200	200	200	200	225	200	225
	O (air space outlet) mm	100	100	100	100	100	100	200	200	200	200	200	225	200	225
Weight (kg)	2.7	4.9	5.3	6.6	7	9.7	13.5/ 14.2	23	27	12	23.5	45	65	35	50

A3 IP 20 with option C

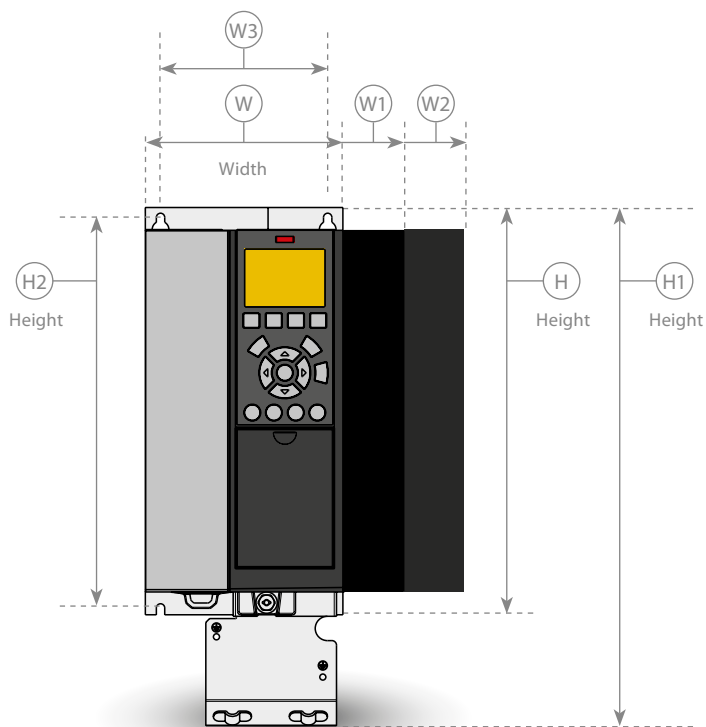

A4 IP 55 with mains disconnect

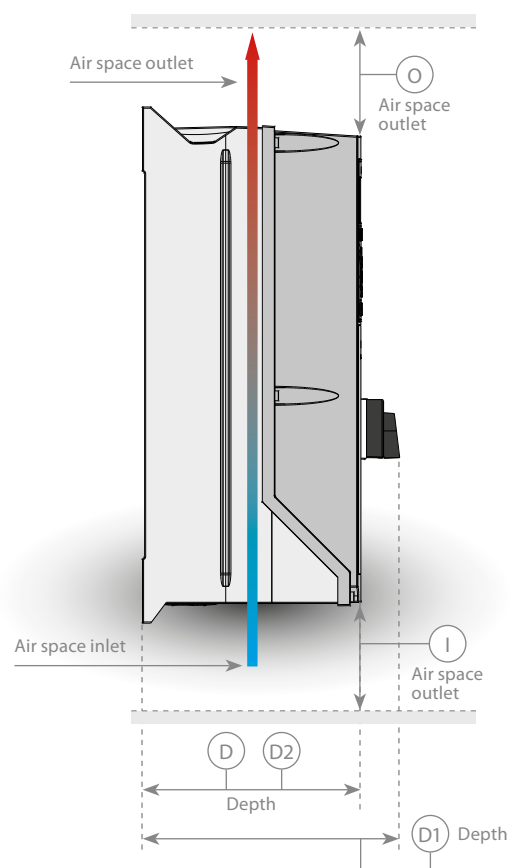

Dimensions and air flow

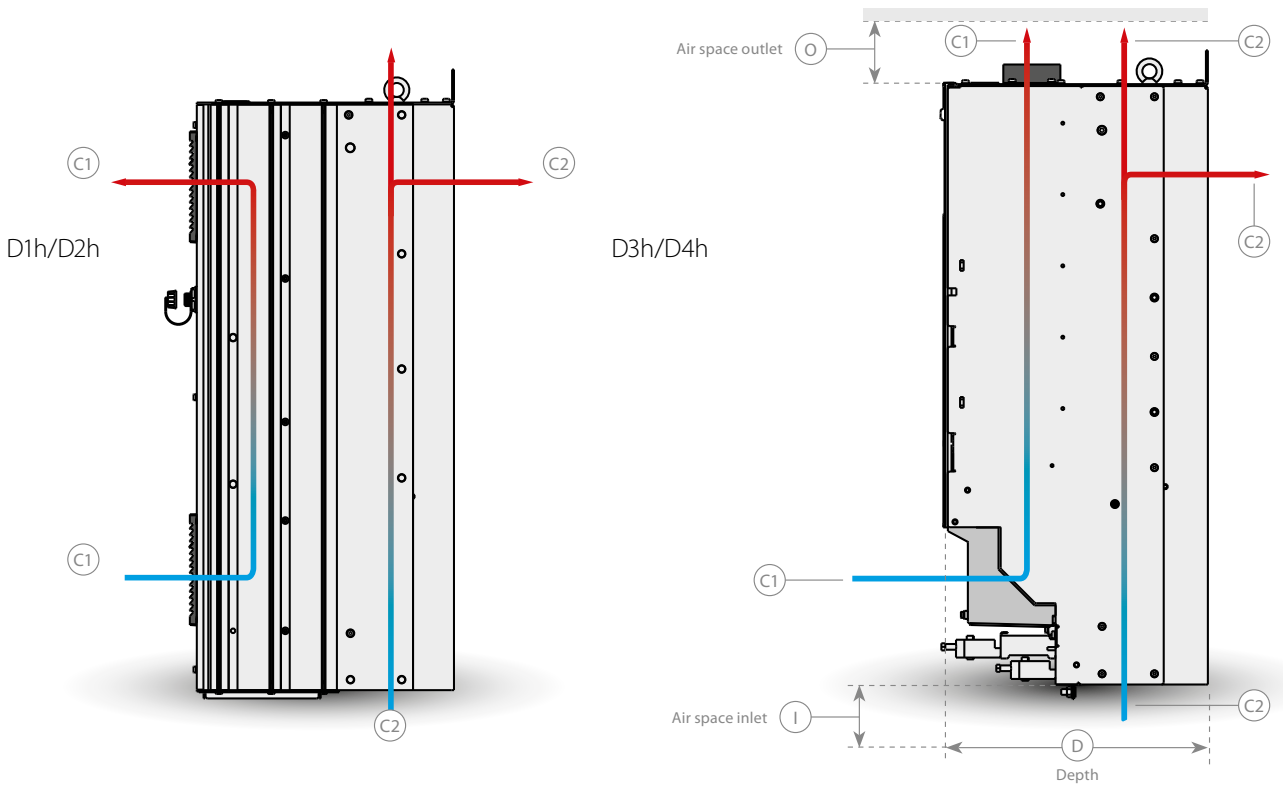
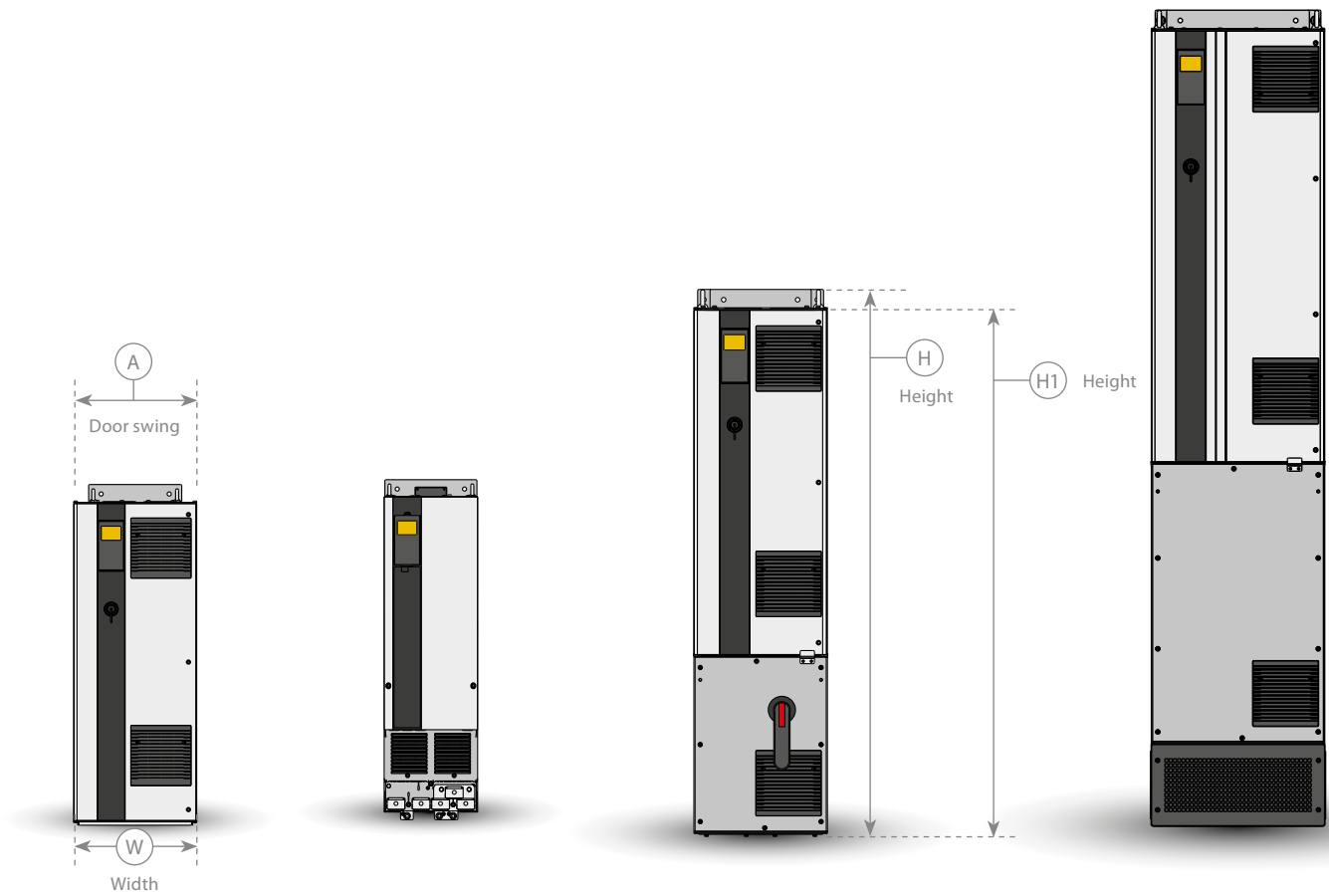

Please see the VLT® High Power Design Guide for other frames, available at <http://www.danfoss.com/Products/Literature/VLT+Technical+Documentation.htm>

D frames

		VLT® AutomationDrive							
Frame		D1h	D2h	D3h	D4h	D5h	D6h	D7h	D8h
Enclosure		IP 21/IP 54		IP 20		IP 21/IP 54			
H mm Height of back plate		901	1107	909	1122	1324	1665	1978	2284
H1 mm Height of product		844	1050	844	1050	1277	1617	1931	2236
W mm		325	420	250	350	325	325	420	420
D mm		378	378	375	375	381	381	384	402
D1 mm With mains disconnect		-	-	-	-	426	426	429	447
Door swing A mm		298	395	n/a	n/a	298	298	395	395
Air cooling	I (air space inlet) mm	225	225	225	225	225	225	225	225
	O (air space outlet) mm	225	225	225	225	225	225	225	225
	C1	102 m³/hr (60 cfm)	204 m³/hr (120 cfm)	102 m³/hr (60 cfm)	204 m³/hr (120 cfm)	102 m³/hr (60 cfm)		204 m³/hr (120 cfm)	
	C2	420 m³/hr (250 cfm)	840 m³/hr (500 cfm)	420 m³/hr (250 cfm)	840 m³/hr (500 cfm)	420 m³/hr (250 cfm)		840 m³/hr (500 cfm)	

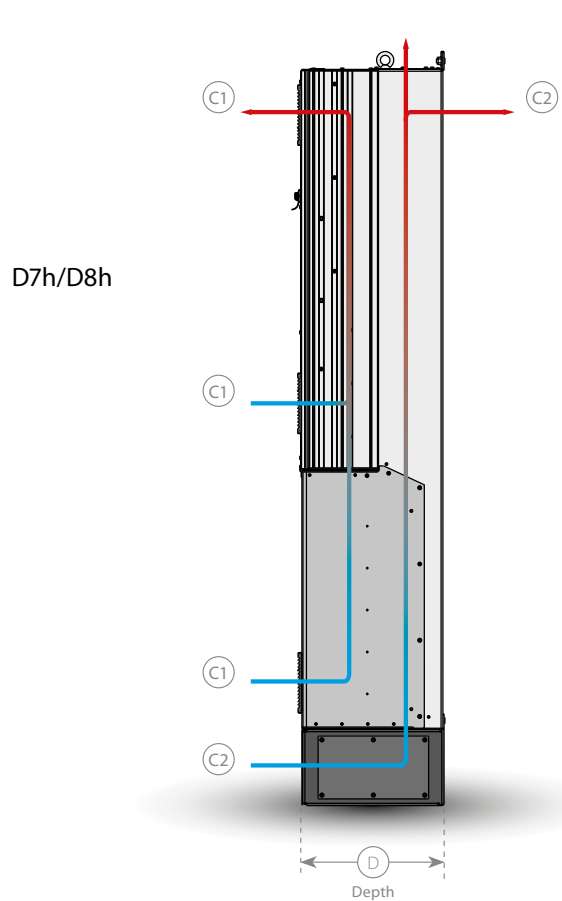
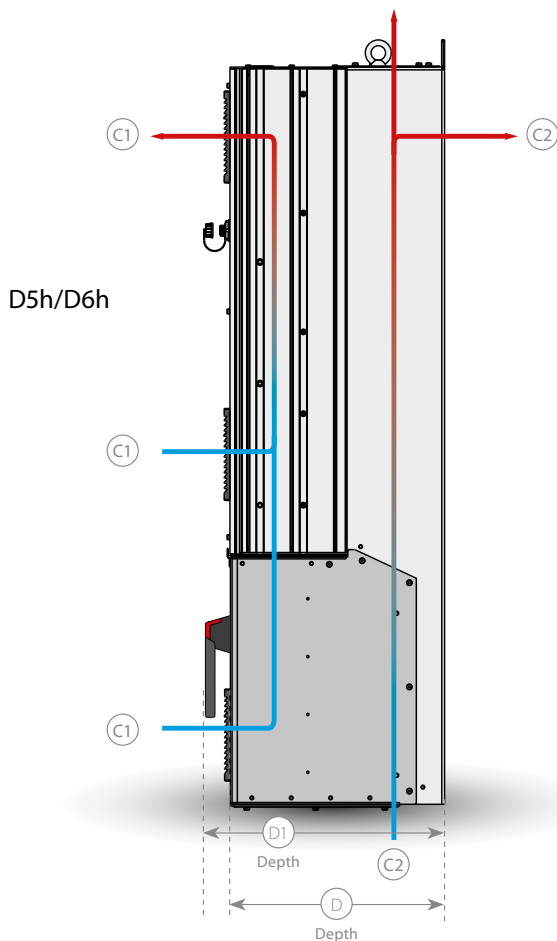

A options: Fieldbuses

For A, B, C and D frames



Fieldbus	FC 301 (A1-frame)	FC 301	FC 302
A			
VLT® PROFIBUS DP V1 MCA 101	■	■	■
VLT® DeviceNet MCA 104	■	■	■
VLT® CANopen MCA 105	■	■	■
VLT® 3000 PROFIBUS Converter MCA 113	–	–	■
VLT® 5000 PROFIBUS Converter MCA 114	–	–	■
VLT® PROFINET MCA 120	■	■	■
VLT® EtherNet/IP MCA 121	■	■	■
VLT® Modbus TCP MCA 122	■	■	■
VLT® POWERLINK MCA 123	■	■	■
VLT® EtherCAT MCA 124	■	■	■
VLT® 5000 DeviceNet Converter MCA 194	–	–	■

VLT® PROFIBUS DP MCA 101

Operating the frequency converter via a fieldbus enables you to reduce the cost of your system, communicate faster and more efficiently, and benefit from an easier user interface.

- VLT® PROFIBUS DP MCA 101 provides wide compatibility, a high level of availability, support for all major PLC vendors, and compatibility with future versions
- Fast, efficient communication, transparent installation, advanced diagnosis and parameterisation and auto-configuration of process data via GSD-file
- A-cyclic parameterisation using PROFIBUS DP-V1, PROFIdrive or Danfoss FC profile state machines, PROFIBUS DP-V1, Master Class 1 and 2

Ordering number
130B1100 standard, 130B1200 coated

VLT® DeviceNet MCA 104

VLT® DeviceNet MCA 104 offers robust, efficient data handling thanks to advanced Producer/Consumer technology.

- This modern communications model offers key capabilities that let you effectively determine what information is needed and when
- Benefit also from ODVA's strong conformance testing policies, which ensure that products are interoperable

Ordering number
130B1102 standard, 130B1202 coated

VLT® CANopen MCA 105

High flexibility and low cost are two of the "cornerstones" for CANopen. The VLT® CANopen MCA 105 option for the AutomationDrive is fully equipped with both high priority access to control and status of the Drive (PDO Communication) and access to all Parameters through acyclic data (SDO Communication).

For interoperability the option has implemented the DSP402 AC drive Profile. This all guarantees standardised handling, interoperability and low cost.

Ordering number
130B1103 standard, 130B1205 coated

VLT® PROFIBUS Converter MCA 113

The VLT® PROFIBUS Converter MCA 113 is a special version of the Profibus options that emulates the VLT® 3000 commands in the VLT® AutomationDrive. The VLT® 3000 can then be replaced by the VLT® AutomationDrive, or the system can be expanded without costly change of the PLC program.

For upgrade to a different fieldbus, the installed converter is easily removed and replaced with a new option. This secures the investment without losing flexibility.

Ordering number
NA standard, 130B1245 coated

VLT® PROFIBUS Converter MCA 114

The VLT® PROFIBUS Converter MCA 114 is a special version of the Profibus options that emulates the VLT® 5000 commands in the VLT® AutomationDrive. The VLT® 5000 can then be replaced by the VLT® AutomationDrive, or the system can be expanded without costly change of the PLC program.

For upgrade to a different fieldbus, the installed converter is easily removed and replaced with a new option. This secures the investment without losing flexibility. The option supports DPV1.

Ordering number
NA standard, 130B1246 coated

VLT® PROFINET MCA 120

VLT® PROFINET MCA 120 uniquely combines the highest performance with the highest degree of openness. The MCA120 gives the user access to the power of Ethernet. The option is designed so that many of the features from the PROFIBUS MCA 101 can be reused, minimising user effort to migrate PROFINET, and securing the investment in PLC program.

- Other features:**
- Built-in web server for remote diagnosis and reading out of basic drive parameters
 - Support of DP-V1 Diagnostic allows easy, fast and standardized handling of warning and fault information into the PLC, improving bandwidth in the system

PROFINET encompasses a suite of messages and services for a variety of manufacturing automation applications, including control, configuration and information.

Ordering number
130B1135 standard, 130B1235 coated

VLT® EtherNet/IP MCA 121

Ethernet is the future standard for communication at the factory floor. The VLT® EtherNet/IP MCA 121 is based on the newest technology available for industrial use and handles even the most demanding requirements. EtherNet/IP extends commercial off-the-shelf Ethernet to the Common Industrial Protocol (CIP™) – the same upper-layer protocol and object model found in DeviceNet.

The VLT® MCA 121 offers advanced features as:

- Built-in high performance switch enabling line-topology, and eliminating the need for external switches
- Advanced switch and diagnoses functions
- Built-in web server
- E-mail client for service notification
- Unicast and Multicast communication

Ordering number
130B1119 standard, 130B1219 coated

VLT® Modbus TCP MCA 122

Modbus TCP is the first industrial Ethernet based protocol for automation. The VLT® Modbus TCP MCA 122 connects to Modbus TCP based networks. It is able to handle connection interval down to 5 ms in both directions, positioning it among the fastest performing Modbus TCP devices in the market. For master redundancy it features hot swapping between two masters.

- Other features:**
- Built-in web-server for remote diagnosis and reading out basic drive parameters
 - An e-mail notifier can be configured for sending an e-mail message to one or several receivers, if certain warnings or alarms occurs, or has cleared again

Ordering number
130B1196 standard, 130B1296 coated

VLT® POWERLINK MCA 123

VLT® POWERLINK MCA 123 represents the second generation of fieldbus. The high bit rate of industrial ethernet can now be used to make the full power of IT technologies used in the automation world available for the factory world.

POWERLINK does not only provide high performance real-time and time synchronisation features. Due to its CANopen-based communication models, network management and device description model offers much more than just a fast communication network.

The perfect solution for:

- Dynamic motion control applications
- Material handling
- Synchronisation and positioning applications

Ordering number

130B1489 standard, 130B1490 coated

VLT® EtherCAT MCA 124

The VLT® EtherCAT MCA 124 offers connectivity to EtherCAT based networks via the EtherCAT Protocol.

The option handles the EtherCAT line communication in full speed, and connection towards the drive of a Interval down to 4 ms in both directions. This allows the MCA124 to participate in networks from low performance up to servo applications.

- EoE Ethernet over EtherCAT support
- HTTP (Hypertext Transfer Protocol) for diagnosis via built-in web server
- SMTP (Simple Mail Transfer Protocol) for e-mail notification
- TCP/IP for easy access to Drive configuration data from MCT 10

Ordering number

130B5546 standard, 130B5646 coated

VLT® DeviceNet Converter MCA 194

The VLT® DeviceNet Converter MCA 194 emulates VLT® 5000 commands in the VLT® AutomationDrive. This means that a VLT® 5000 can be replaced by the VLT® AutomationDrive or an existing system can be expanded, without costly change of the PLC program.

For a later upgrade to a different fieldbus, the installed converter can easily be removed and replaced with a different option. This secures the investment without losing flexibility. The option emulates I/O instances & explicite messages of a VLT® 5000.

Ordering number

NA standard, 130B5601 coated



B options: Functional extensions

For A, B, C and D frames

Funcional extensions	FC 301 (A1-frame)	FC 301	FC 302
B			
VLT® General Purpose MCB 101	■	■	■
VLT® Encoder Input MCB 102	■	■	■
VLT® Resolver Input MCB 103	■	■	■
VLT® Relay Option MCB 105	■	■	■
VLT® Safe PLC I/O MCB 108	■	■	■
VLT® PTC Thermistor Card MCB 112	–	–	■
VLT® Sensor Input Card MCB 114	■	■	■
VLT® Safety Option MCB 140	■	–	■
VLT® Safety Option MCB 150 TTL	–	–	■
VLT® Safety Option MCB 151 HTL	–	–	■

VLT® General Purpose I/O MCB 101

This I/O option offers an extended number of control inputs and outputs:

- 3 digital inputs 0-24 V:
Logic '0' < 5 V; Logic '1' > 10V
- 2 analogue inputs 0-10 V:
Resolution 10 bit plus sign
- 2 digital outputs NPN/PNP push pull
- 1 analogue output 0/4-20 mA
- Spring loaded connection

Ordering number

130B1125 standard, 130B1212 coated

VLT® Encoder Input MCB 102

A universal option for connection of encoder feedback from either a motor or a process. Feedback for asynchronous or brushless servo (Permanent Magnet) motors.

Encoder module supports:

- Incremental encoders
- SinCos encoders as Hyperface®
- Power supply for encoders
- RS422 interface
- Connection to all standard 5 V incremental encoders
- Spring-loaded connection

Ordering number

130B1115 standard, 130B1203 coated

VLT® Resolver Input MCB 103

Supports resolver feedback for asynchronous or brushless servo (Permanent Magnet) motors.

- Primary foltage2 – 8 Vrms
- Primary frequency2.0 kHz – 15 kHz
- Primary current max50 mA rms
- Secondary input voltage4 Vrms
- Spring loaded connection

Ordering number

130B1127 standard, 130B1227 coated

VLT® Relay Option MCB 105

Makes it possible to extend relay functions with 3 additional relay outputs.

Max. terminal load:

- AC-1 Resistive load240 V AC 2 A
- AC-15 Inductive load @cos fi 0.4240 V AC 0.2 A
- DC-1 Resistive load24 V DC 1 A
- DC-13 Inductive load @cos fi 0.424 V DC 0.1 A

Min. terminal load:

- DC 5 V10 mA
- Max switch rate at rated load/min. load6 min⁻¹/20 sec⁻¹
- Protects control cable connection
- Spring-loaded control wire connection

Ordering number

130B1110 standard, 130B1210 coated

VLT® Safe PLC I/O MCB 108

The VLT® AutomationDrive FC 302 provides a safety input based on a single pole 24 V DC input.

- For the majority of applications this input enables the user to implement safety in a cost-effective way. For application that works with more advanced products like Safety PLC, Lightcurtains etc. the Safe PLC interface enables the connection of a two wire safety link
- The Safe PLC Interface allows the Safe PLC to interrupt on the plus or the minus link without interfering the sense signal of the Safe PLC

Ordering number

130B1120 standard, 130B1220 coated

VLT® PTC Thermistor Card MCB 112

With the VLT® PTC Thermistor Card MCB 112, the VLT® AutomationDrive FC 302 enables improved surveillance of the motor condition compared to the built-in ETR function and thermistor terminal.

- Protects the motor from overheating
- ATEX approved for use with Ex d and Ex e motors (EX e only FC 302)
- Uses Safe Stop function, which is approved in accordance with SIL 2 IEC 61508

Ordering number

NA standard, 130B1137 coated

B options: Functional extensions

For A, B, C and D frames



VLT® Sensor Input Card MCB 114

The option protects the motor from being overheated by monitoring the bearings and windings temperature in the motor. Both limits as well as action are adjustable, and the individual sensor temperature is visible as a read-out on the display or by fieldbus.

- Protects the motor from overheating
- Three self-detecting sensor inputs for 2 or 3 wire PT100/PT1000 sensors
- One additional analogue input 4-20 mA

Ordering number
130B1172 standard, 130B1272 coated

VLT® Safety Option MCB 140 Series

VLT® Safety Option MCB 140 Series are safety options providing Safe Stop 1 (SS1), Safely Limited Speed (SLS) and Safe Speed Monitor (SSM) functionality.

The options can be used up to PL e according to ISO 13849-1.

MCB 140 is a standard B-Option while MCB 141 offers the same functionality in an external 45 mm housing. MCB141 enables the user to use the MCB 140 functionality also if another B-Option is used.

Different operating modes can be easily configured by using the on board display and buttons. The options provide only a limited set of parameters for easy and fast parameterization.

- MCB 140 standard B-Option
- MCB 141 external Option
- Single channel or dual channel operation possible
- Proximity switch as speed feedback
- SS1, SLS and SMS functionality
- Easy and fast parameterization

Ordering number
130B6443 MCB 140, 130B6447 MCB 141

VLT® Safety Option MCB 150 Series

The VLT® Safety Option MCB 150 Series expands the Safe Torque Off STO function, which is integrated in a standard VLT® Automation-Drive.

By using the Safe Stop 1 function it is possible to perform a controlled stop before removing torque. Using the Safely Limited Speed SLS function it is also able to monitor whether a specified speed is exceeded.

The functions can be used up to PL d according to EN ISO 13849 and SIL 2 according to IEC 61508.

- Additional standards-compliant safety functions
- Replacement of external safety equipment
- Reduced space requirements
- 2 safe programmable inputs
- 1 safe output (for T37)
- Easier machine certification
- Drive can be powered continuously
- Safe LCP Copy
- Dynamic commissioning report
- TTL (MCB150) or HTL (MCB151) encoder as speed feedback

Ordering number
130B3280 MCB 150, 130B3290 MCB 151

C options: Motion controls and NAMUR

For A, B, C and D frames



Option slot	FC 301 (A1-frame)	FC 301	FC 302
C			
VLT® Motion Control MCO 305	-	■	■
VLT® Synchronizing Control MCO 350	-	■	■
VLT® Positioning Controller MCO 351	-	■	■
VLT® Extended Relay Card MCB 113	-	■	■

VLT® Motion Control MCO 305

An integrated programmable motion controller for VLT® AutomationDrive FC 301 and FC 302. The option adds functionality and flexibility to the already very comprehensive standard functionality of these drives.

VLT® Motion Control MCO 305 is optimised for all types of positioning and synchronising applications.

- Synchronisation (electronic shaft), positioning and electronic cam control
- 2 inputs supporting both incremental and absolute encoders
- 1 encoder output (virtual master function)
- 10 digital inputs
- 8 digital outputs
- Send and receive data via fieldbus interface (requires fieldbus option)
- PC software tools for programming and commissioning

Ordering number
130B1134 standard, 130B1234 coated

VLT® Synchronizing Controller MCO 350

The VLT® Synchronizing Controller MCO 350 for VLT® AutomationDrive expands the functional properties of the converter in synchronising applications, and replaces traditional mechanical solutions.

- Displays actual synchronising error on frequency converter control panel
- Speed synchronising
- Position (angle) synchronising with or without marker correction
- On-line adjustable gear ratio
- On-line adjustable position (angle) offset
- Encoder output with virtual master function for synchronisation of multiple followers
- Homing

Ordering number
130B1152 standard, 130B1252 coated

VLT® Positioning Controller MCO 351

The VLT® Positioning Controller MCO 351 offers a host of user-friendly benefits for positioning applications in many industries. They are based on a range of thought-through and innovative features.

- Direct positioning via Fieldbus
- Relative positioning
- Absolute positioning
- Touch probe positioning
- End limit handling (software and hardware)
- Mechanical brake handling (programmable hold delay)
- Error handling
- Jog speed/manual operation
- Marker related positioning
- Home function

Ordering number
130B1153 standard, 130B1253 coated

VLT® Extended Relay Card MCB 113

The VLT® Extended Relay Card MCB 113 adds inputs/outputs to VLT® AutomationDrive for increased flexibility.

- 7 digital inputs
- 2 analogue outputs
- 4 SPDT relays
- Meets NAMUR recommendations
- Galvanic isolation capability

Ordering number
130B1164 standard, 130B1264 coated



D option: External power supply

For A, B, C and D frames

Option slot	FC 301 (A1-frame)	FC 301	FC 302
D			
VLT® 24 V DC Supply Option MCB 107	-	■	■

VLT® 24 V DC Supply MCB 107

The option is used to connect an external DC supply to keep the control section and any installed option alive during power failure.

- Input voltage range...24 V DC +/- 15% (max. 37 V in 10 sec.)
- Max. input current2.2 A
- Max. cable length75 m
- Input capacitance load < 10 uF
- Power-up delay< 0.6 s

Ordering number
130B1108 standard, 130B1208 coated

Accessories

For A, B, C and D frames

LCP	FC 301 (A1-frame)	FC 301	FC 302
VLT® Control Panel LCP 101 (Numeric) Ordering number: 130B1124	■	■	■
VLT® Control Panel LCP 102 (Graphical) Ordering number: 130B1107	■	■	■
LCP Panel Mounting Kit Ordering number for IP20 enclosure 130B1113: With fasteners, gasket, graphical LCP and 3 m cable 130B1114: With fasteners, gasket, numerical LCP and 3 m cable 130B1117: With fasteners, gasket and without LCP and with 3 m cable 130B1170: With fasteners, gasket and without LCP Ordering number for IP55 enclosure 130B1129: With fasteners, gasket, blind cover and 8 m "free end" cable	■	■	■
Power Options*		FC 301	FC 302
VLT® Sine-Wave Filter MCC 101	■	■	■
VLT® dU/dt Filter MCC 102	■	■	■
VLT® Common Mode Filters MCC 105	■	■	■
VLT® Advanced Harmonic Filter AHF 005/010	■	■	■
VLT® Brake Resistors MCE 101	■	■	■
Accessories		FC 301	FC 302
Profibus SUB-D9 Adapter IP 20, A2 and A3 Ordering number: 130B1112	-	■	■
Adapter Plate for VLT® 3000 and VLT® 5000	-	■	■
Option Adapter Ordering number: 130B1130 standard, 130B1230 coated	-	-	■
USB Extension Ordering number: 130B1155: 350 mm cable, 130B1156: 650 mm cable	-	■	■
IP 21/Type 1 (NEMA 1) Kit Ordering number: 130B1121: For frame size A1 130B1189: For frame size B4 130B1122: For frame size A2 130B1191: For frame size C3 130B1123: For frame size A3 130B1193: For frame size C4 130B1187: For frame size B3	■	■	■
Motor connector Ordering number: 130B1065: frame A2 to A5 (10 pieces)	-	■	■
Mains connector Ordering number: 130B1066: 10 pieces mains connectors IP 55 130B1067: 10 pieces mains connectors IP20/21	-	■	■
Relays 1 terminal Ordering number: 130B1069 (10 pieces 3 pole connectors for relay 01)	■	■	■
Relays 2 terminal Ordering number: 130B1068 (10 pieces 3 pole connectors for relay 02)	■	■	■
Control card terminals Ordering number: 130B0295	■	■	■
VLT® Leakage Current Monitor Module RCMB20/RCMB35 Ordering number: 130B5645: A2-A3 130B6226: C3 130B5764: B3 130B5647: C4 130B5765: B4	-	■	■

*Ordering number: See relevant Design Guide

Ordering typecode for A, B, C and D frames



[1] Application (character 4-6)	
301	VLT® AutomationDrive FC 301
302	VLT® AutomationDrive FC 302
[2] Power size (character 7-10)	
PK25	0.25 kW / 0.33 HP
PK37	0.37 kW / 0.50 HP
PK55	0.55 kW / 0.75 HP
PK75	0.75 kW / 1.0 HP
P1K1	1.1 kW / 1.5 HP
P1K5	1.5 kW / 2.0 HP
P2K2	2.2 kW / 3.0 HP
P3K0	3.0 kW / 4.0 HP
P3K7	3.7 kW / 5.0 HP
P4K0	4.0 kW / 5.5 HP
P5K5	5.5 kW / 7.5 HP
P7K5	7.5 kW / 10 HP
P11K	11 kW / 15 HP
P15K	15 kW / 20 HP
P18K	18.5 kW / 25 HP
P22K	22 kW / 30 HP
P30K	30 kW / 40 HP
P37K	37 kW / 50 HP
P45K	45 kW / 60 HP
P55K	55 kW / 75 HP
P75K	75 kW / 100 HP
N55K	55 kW / 75 HP
N75K	75 kW / 100 HP
N90K	90 kW / 125 HP
N110	110 kW / 150 HP
N132	132 kW / 200 HP
N160	160 kW / 250 HP
N200	200 kW / 300 HP
N250	250 kW / 350 HP
N315	315 kW / 450 HP
[3] AC Line Voltage (character 11-12)	
T2	3 x 200/240 V AC
T4	3 x 380/480 V AC (FC 301)
T5	3 x 380/500 V AC (FC 302)
T6	3 x 525/600 V AC (FC 302)
T7	3 x 525/690 V AC (FC 302)
[4] Enclosure (character 13-15)	
For cabinet mounting:	
Z20	IP 20 (frame A1, FC 301 only)
E20	IP 20/Chassis (frame A2, A3, B3, B4, C3, C4, D3h, D4h)
Standalone:	
E21	IP 21 /Type 1 (frame B1, B2, C1, C2, D1h, D2h, D5h, D6h, D7h, D8h)
E54	IP 54/Type 12 (frame D1h, D2h, D5h, D6h, D7h, D8h)
E55	IP 55 (frame A5, B1, B2, C1, C2)
E66	IP 66/Type 4X outdoor (frame A5, B1, B2, C1, C2)
Z55	IP 55/Type 12 (frame A4)
Z66	IP 66/NEMA 4X (frame A4)

Special designs:	
P20	IP 20 (frame B4, C3, C4 – with back plate)
E2M	IP 21 /Type 1 with mains shield (frame D1h, D2h, D5h, D6h, D7h, D8h)
P21	IP 21 /Type 1 (frame as E21 – with back plate)
E5M	IP 54/Type 12 with mains shield (frame D1h, D2h, D5h, D6h, D7h, D8h)
P55	IP 55 (frame as E55 – with back plate)
Y55	IP 55 (frame as Z55 – with back plate)
Y66	IP 66/NEMA 4X (frame as Z66 – with back plate)
[5] RFI filter, terminal and monitoring options – EN/IEC 61800-3 (character 16-17)	
H1	RFI-Filter Class A1/B (C1) (A, B and C frames only)
H2	RFI-Filter, Class A2 (C3)
H3	RFI-Filter Class A1/B ¹⁾ (A, B and C frames only)
H4	RFI-Filter, Class A1 (C2) (B, C and D frames only)
H5	RFI-Filter, Class A2 (C3) Marine ruggedized
HX	No RFI-Filter (only 600 V) (A, B and C frames only)
[6] Braking and safety (character 18)	
X	No brake IGBT
B	Brake IGBT
T	Safe Stop (FC 301 – only in A1 frame. Standard on FC 302)
R	Regeneration terminals (D frame only)
U	Brake IGBT plus Safe Stop (FC 301 – only in A1 frame. Standard on FC 302)
[7] LCP Display (character 19)	
X	Blank faceplate, no LCP installed
N	Numerical Local Control Panel (LCP 101)
G	Graphical Local Control Panel (LCP 102)
[8] PCB Coating – IEC 721-3-3 (character 20)	
X	Standard coated PCB Class 3C2
C	Coated PCB Class 3C3
R	Coated PCB Class 3C3 + ruggedized
[9] Mains input (character 21)	
X	No mains option
1	Mains disconnect
7	Fuses (D frame only)
8	Mains disconnect and loadsharing (B1, B2, C1 and C2 frames only)
A	Fuses and loadsharing terminals (D frame IP 20 only)
D	Loadsharing terminals (B1, B2, C1 and C2 frames only. D-frame only IP 20)
3	Mains disconnect + fuse (D frame only)
4	Mains contactor + fuse (D frame only)
E	Mains disconnect + contactor + fuse (D frame only)
J	Circuit breaker + fuse (D frame only)
[10] Power terminals and motor starters (character 22)	
X	Standard cable entries
O	Metric cable entries
[11] Auxiliary 24 V supply and external temperature monitoring (character 23)	
X	No adaptation
Q	Heat-sink access panel (D frame only)

[12] Special version (character 24-27)	
SXXX	No option
[13] LCP language (character 28)	
X	Standard language package including English, German, French, Spanish, Danish, Italian and Finnish
Contact factory for other language options	
[14] Fieldbus (character 29-30)	
AX	No option
A0	VLT® PROFIBUS DP V1 MCA 101
A4	VLT® DeviceNet MCA 104
A6	VLT® CANopen MCA 105
AT	VLT® 3000 PROFIBUS Converter MCA 113 (FC 302 only)
AU	VLT® 5000 PROFIBUS Converter MCA 114 (FC 302 only)
AL	VLT® PROFINET MCA 120
AN	VLT® EtherNet/IP MCA 121
AQ	VLT® Modbus TCP MCA 122
AY	VLT® POWERLINK MCA 123
A8	VLT® EtherCAT MCA 124
AV	VLT® 5000 DeviceNet Converter MCA 194
[15] Application (character 31-32)	
BX	No application option
BK	VLT® General Purpose MCB 101
BR	VLT® Encoder Input MCB 102
BU	VLT® Resolver Input MCB 103
BP	VLT® Relay Option MCB 105
BZ	VLT® Safety PLC I/O MCB 108 (FC 302 only)
B2	VLT® PTC Thermistor Card MCB 112 (FC 302 only)
B4	VLT® Sensor Input Card MCB 114
B6	VLT® Safety Option MCB 150 TTL (FC 302 only)
B7	VLT® Safety Option MCB 151 HTL (FC 302 only)
[16] Motion Control (character 33-34)	
CX	No motion control option
C4	VLT® Motion Control MCO 305
C4	VLT® Synchrozing Control MCO 350
C4	VLT® Positioning Controller MCO 351
[17] Extended Relay (character 35)	
X	No selection
R	VLT® Extended Relay Card MCB 113
[18] Motion Software (character 36-37)	
XX	No software option Note: C4 option in [16] selected with no motion software in [18] will require programming by qualified individual
10	VLT® Synchronizing Controller MCO 350 (must select C4 in position [16])
11	VLT® Positioning Controller MCO 351 (must select C4 in position [16])
[19] Control Power Backup Input (character 38-39)	
DX	No DC input installed
D0	VLT® 24 V DC Supply Option MCB 107 Not available in A1 frame

1) reduced motor cable length

Please beware that not all combinations are possible. Find help configuring your drive with the online configurator found under: driveconfg.danfoss.com

Based on your selection, Danfoss manufactures the desired VLT® AutomationDrive. You will receive a fully assembled frequency converter, tested under full load conditions.

Power ratings and enclosures

VLT® AutomationDrive		T2 200 – 240 V				T4/T5 380 – 480/500 V						T6 525 – 600 V				T7 525 – 690 V									
FC 300	kW		A		IP20	IP21	IP55	IP66	A HO		A NO		IP20	IP21	IP54	IP55	IP66	A HO		A NO		IP20	IP21	IP54	IP55
	HO	NO	HO	NO					≤440 V	>440 V	≤440 V	>440 V						≤550 V	>550 V	≤550 V	>550 V				
PK25	0.25		1.8																						
PK37	0.37		2.4																						
PK55	0.55		3.5																						
PK75	0.75		4.6		A1*/A2	A2	A4/A5	A4/A5																	
P1K1	1.1		6.6																						
P1K5	1.5		7.5																						
P2K2	2.2		10.6		A2																				
P3K0	3.0		12.5		A3	A3	A5	A5																	
P3K7	3.7		16.7																						
P4K0	4.0																								
P5K5	5.5	7.5	24.2	30.8	B3	B1	B1	B1																	
P7K5	7.5	11	30.8	46.2																					
P11K	11	15	46.2	59.4	B4	B2	B2	B2																	
P15K	15	18	59.4	74.8																					
P18K	18.5	22	74.8	88	C3	C1	C1	C1																	
P22K	22	30	88	115																					
P30K	30	37	115	143	C4	C2	C2	C2																	
P37K	37	45	143	170																					
P45K	45	55																							
P55K	55	75																							
P75K	75	90																							
N55K	55	75																							
N75K	75	90																							
N90K	90	110																							
N110	110	132																							
N132	132	160																							
N160	160	200																							
N200	200	250																							
N250	250	315																							
N315	315	400																							

A1*: For selection of A1 see enclosure types in the code position 4 (FC 301 only)



What VLT® is all about

Danfoss VLT Drives is the world leader among dedicated drives providers – and still gaining market share.

Environmentally responsible

VLT® products are manufactured with respect for the safety and well-being of people and the environment.

All frequency converter factories are certified according to ISO 14001 and ISO 9001 standards.

All activities are planned and performed taking into account the individual employee, the work environment and the external environment. Production takes place with a minimum of noise, smoke or other pollution and environmentally safe disposal of the products is pre-prepared.

UN Global Compact

Danfoss has signed the UN Global Compact on social and environmental responsibility and our companies act responsibly towards local societies.

Impact on energy savings

One year's energy savings from our annual production of VLT® drives will save the energy equivalent to the energy production from a major power plant. Better process control at the same time improves product quality and reduces waste and wear on equipment.

Dedicated to drives

Dedication has been a key word since 1968, when Danfoss introduced the world's first mass produced variable speed drive for AC motors – and named it VLT®.

Twenty five hundred employees develop, manufacture, sell and service drives and soft starters in more than one hundred countries, focused only on drives and soft starters.

Intelligent and innovative

Developers at Danfoss VLT Drives have fully adopted modular principles in development as well as design, production and configuration.

Tomorrow's features are developed in parallel using dedicated technology platforms. This allows the development of all elements to take place in parallel, at the same time reducing time to market and ensuring that customers always enjoy the benefits of the latest features.

Rely on the experts

We take responsibility for every element of our products. The fact that we develop and produce our own features, hardware, software, power modules, printed circuit boards, and accessories is your guarantee of reliable products.

Local backup – globally

VLT® motor controllers are operating in applications all over the world and Danfoss VLT Drives' experts located in more than 100 countries are ready to support our customers with application advice and service wherever they may be.

Danfoss VLT Drives experts don't stop until the customer's drive challenges are solved.

