

Technical Information

Proline Prosonic Flow B 200

Ultrasonic transit time flowmeter



The device for accurate, reliable biogas measurement with loop-powered technology

Application

- The measuring principle is unaffected by gas composition
- Inline flowmeter for wet biogas and digester gas under fluctuating process conditions

Device properties

- Multivariable device: flow, temperature and methane
- Medium temperature: 0 to 80 °C (32 to 176 °F)
- Process pressure: 0.7 to 11 bar a (10.2 to 159 psi a)
- Loop-powered technology
- Robust dual-compartment housing
- Plant safety: worldwide approvals

Your benefits

- Integrated real-time methane fraction measurement
- Optimized for low pressure gas – specialized sensor design
- No additional pressure loss – full bore design
- Process transparency – diagnostic capability
- Convenient device wiring – separate connection compartment
- Safe operation – no need to open the device due to display with touch control, background lighting
- Integrated verification – Heartbeat Technology







Table of contents

Document information	3	Process	27
Symbols used	3	Medium temperature range	27
Function and system design	3	Pressure-temperature ratings	27
Measuring principle	3	Flow limit	28
Measuring system	4	Pressure loss	29
Input	5	System pressure	29
Measured variable	5	Thermal insulation	29
Measuring range	6	Mechanical construction	29
Operable flow range	6	Dimensions in SI units	29
Input signal	6	Dimensions in US units	33
Output	7	Weight	37
Output signal	7	Materials	38
Signal on alarm	8	Process connections	40
Load	9	Operability	41
Ex connection data	10	Operating concept	41
Low flow cut off	13	Local operation	41
Galvanic isolation	13	Remote operation	42
Protocol-specific data	13	Service interface	43
Power supply	15	Certificates and approvals	43
Terminal assignment	15	CE mark	43
Supply voltage	15	C-Tick symbol	43
Power consumption	16	Ex approval	43
Current consumption	16	HART certification	44
Power supply failure	16	Pressure Equipment Directive	44
Electrical connection	17	Other standards and guidelines	44
Potential equalization	19	Ordering information	45
Terminals	19	Application packages	45
Cable entries	19	Diagnostics functions	45
Cable specification	19	Heartbeat Technology	46
Overvoltage protection	20	Accessories	46
Performance characteristics	20	Device-specific accessories	46
Reference operating conditions	20	Communication-specific accessories	47
Maximum measured error	20	Service-specific accessories	48
Repeatability	21	System components	48
Response time	21	Documentation	49
Influence of ambient temperature	21	Standard documentation	49
Installation	22	Supplementary device-dependent documentation	49
Mounting location	22	Registered trademarks	50
Orientation	22		
Inlet and outlet runs	23		
Special mounting instructions	24		
Environment	25		
Ambient temperature range	25		
Storage temperature	27		
Degree of protection	27		
Shock resistance	27		
Vibration resistance	27		
Electromagnetic compatibility (EMC)	27		









Document information

Symbols used





Electrical symbols

Symbol	Meaning	Symbol	Meaning
	Direct current		Alternating current
	Direct current and alternating current		Ground connection A grounded terminal which, as far as the operator is concerned, is grounded via a grounding system.
	Protective ground connection A terminal which must be connected to ground prior to establishing any other connections.		Equipotential connection A connection that has to be connected to the plant grounding system: This may be a potential equalization line or a star grounding system depending on national or company codes of practice.

Symbols for certain types of information

Symbol	Meaning
	Permitted Procedures, processes or actions that are permitted.
	Preferred Procedures, processes or actions that are preferred.
	Forbidden Procedures, processes or actions that are forbidden.
	Tip Indicates additional information.
	Reference to documentation
	Reference to page
	Reference to graphic
	Visual inspection

Symbols in graphics

Symbol	Meaning	Symbol	Meaning
1, 2, 3,...	Item numbers		Series of steps
A, B, C, ...	Views	A-A, B-B, C-C, ...	Sections
	Hazardous area		Safe area (non-hazardous area)
	Flow direction		

Function and system design

Measuring principle

A Proline Prosonic Flow ultrasonic flowmeter measures the flow rate of the passing fluid by using sensor pairs located on opposite sides of the meter body and at an angle so that one of the sensors in

the pair is slightly mounted downstream. The design is non-invasive and does not have any moving parts.

The flow signal is established by alternating an acoustic signal between the sensor pairs and measuring the transit time of each transmission. Then utilizing the fact that sound travels faster with the flow versus against the flow, this differential time (ΔT) can be used to determine the fluids velocity between the sensors.

The volume flow rate is established by combining all the flow velocities determined by the sensor pairs with the cross sectional area of the meter body and extensive knowledge about fluid flow dynamics. The design of the sensors and their position ensures that only a short straight run of pipe upstream of the meter is required after typical flow obstructions such as bends in one or two planes.

Advance digital signal processing facilitates constant validation of the flow measurement reducing susceptibility to multiphase flow conditions and increases the reliability of the measurement.

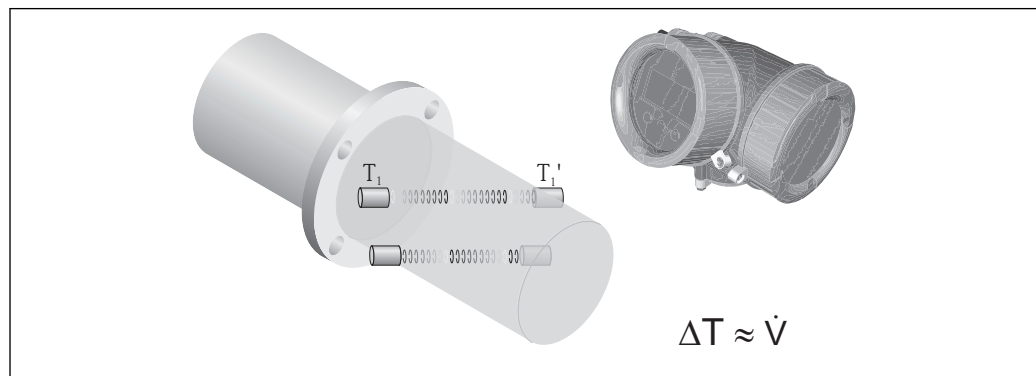

Direct measurement of the methane fraction (CH₄)

The sound velocity, temperature and chemical composition of a gas are directly dependant on each other. If two of these characteristic quantities are known, the third can be calculated. The higher the gas temperature or the methane fraction, the higher the sound velocity in biogas.

Since the measuring device accurately measures both the sound velocity and the current gas temperature, the methane fraction can be calculated directly and displayed on site without the need for an additional measuring instrument → 1, 4.

The relative humidity of biogas is usually 100%. Thus, the water content can be determined by the temperature measurement and can be compensated for.

The measuring device is unique in its ability to measure the methane fraction directly, making it possible to monitor the gas flow and gas quality 24/7. In this way, operators of a biogas plant, for example, can react swiftly and specifically to problems in the digestion process.

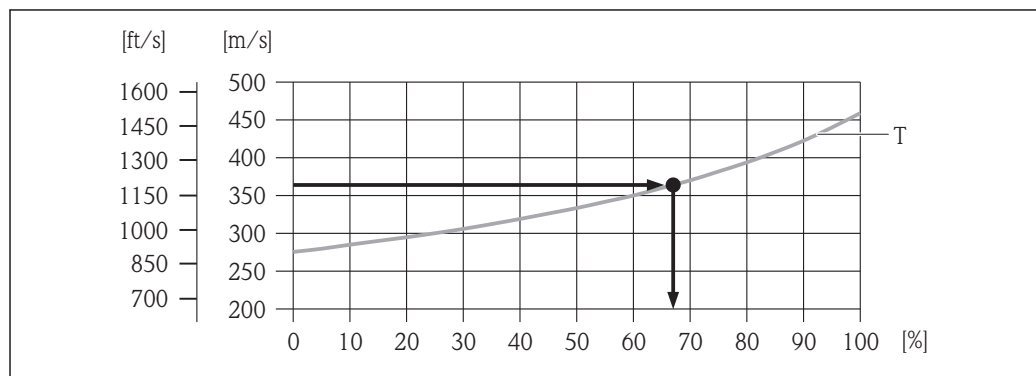

1 Calculation of the methane fraction [%] based on the sound velocity [m/s (ft/s)] and a temperature T of 40 °C (104 °F), for example.

Measuring system

The device consists of a transmitter and a sensor.

The device is available as a compact version:
The transmitter and sensor form a mechanical unit.

Transmitter

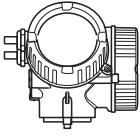
<p>Prosonic Flow 200</p>  <p>A0013471</p>	<p>Device versions and materials:</p> <ul style="list-style-type: none"> ■ Compact, aluminum coated: Aluminum, AlSi10Mg, coated ■ Compact, stainless: For maximum corrosion resistance: stainless steel 1.4404 (316L) <p>Configuration:</p> <ul style="list-style-type: none"> ■ External operation via four-line, illuminated local display with touch control and guided menus ("Make-it-run" wizards) for applications ■ Via operating tools (e.g. FieldCare)
---	--

Sensor

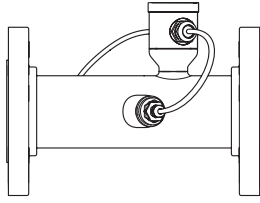
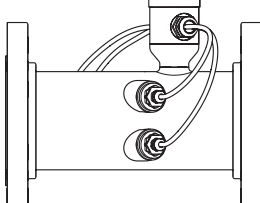
<p>Prosonic Flow B</p> <p><i>Single-path version: DN 50 (2"), DN 80 (3")</i></p>  <p>A0015826</p>	<ul style="list-style-type: none"> ■ Designed exclusively to measure: <ul style="list-style-type: none"> - Biogas - Firedamp - Air - Methane - Nitrogen - Gas with a very high methane fraction ■ Range of nominal diameter: DN 50 to 200 (2 to 8") ■ Materials: <ul style="list-style-type: none"> - Sensor: Stainless steel 1.4404 (316L), cold worked Stainless steel 1.4435 (316L), cold worked - Process connections: Stainless steel 1.4301 (304), Stainless steel 1.4306 (304L), Stainless steel 1.4404 (316L), Steel S235JR, Carbon steel A105
<p><i>Two-path version: DN 100 to 200 (4 to 8")</i></p>  <p>A0015452</p>	

Input

Measured variable

Direct measured variables

Volume flow

Calculated measured variables

- Corrected volume flow
- Mass flow

Optional measured variables (can be ordered)

Order code for "Sensor version", option 2 "Volume flow + Biogas analysis"

- Corrected methane volume flow
- Energy flow
- Methane fraction
- Gross calorific value
- Wobbe index
- Temperature

Measuring range*Standard (order code for "Calibration flow", option 1 "Operable flow range 30 : 1")*

Nominal diameter		Velocity		Effective volume flow	
[mm]	[in]	[m/s]	[ft/s]	[m ³ /h]	[ft ³ /h]
50	2	1 to 30	3.28 to 98.4	9 to 269	316 to 9495
80	3	1 to 30	3.28 to 98.4	20 to 611	720 to 21592
100	4	1 to 30	3.28 to 98.4	34 to 1032	1215 to 36443
150	6	1 to 30	3.28 to 98.4	76 to 2290	2695 to 80862
200	8	1 to 30	3.28 to 98.4	131 to 3925	4620 to 138596

Optional (order code for "Calibration flow", option 2 "Operable flow range 100 : 1")

Nominal diameter		Velocity		Effective volume flow	
[mm]	[in]	[m/s]	[ft/s]	[m ³ /h]	[ft ³ /h]
50	2	0.3 to 30	0.98 to 98.4	3 to 269	95 to 9495
80	3	0.3 to 30	0.98 to 98.4	6 to 611	215 to 21592
100	4	0.3 to 30	0.98 to 98.4	11 to 1032	363 to 36443
150	6	0.3 to 30	0.98 to 98.4	25 to 2290	805 to 80862
200	8	0.3 to 30	0.98 to 98.4	43 to 3925	1365 to 138596

The values in the table should be regarded as reference values.



To calculate the measuring range, use the *Applicator* sizing tool → 48

Recommended measuring range

"Flow limit" section → 28

Operable flow range

- 30 : 1 (standard; order code for "Calibration Flow", option 1 "Operable flow range 30 : 1")
- 100 : 1 (optional; order code for "Calibration Flow", option 2 "Operable flow range 100 : 1")

Flow rates above the preset full scale value do not overload the amplifier so the totalized values are registered correctly.

Input signal**Current input**

Current input	4-20 mA (passive)
Resolution	1 μ A
Voltage drop	Typically: 2.2 to 3 V for 3.6 to 22 mA
Maximum voltage	≤ 35 V
Possible input variables	Pressure

External measured values

To increase the accuracy of certain measured variables, the automation system can continuously write the operating pressure to the measuring device. Endress+Hauser recommends the use of a pressure measuring device for absolute pressure, e.g. Cerabar M or Cerabar S



Various pressure transmitters can be ordered from Endress+Hauser: see "Accessories" section → 48

It is recommended to read in external measured values to calculate the following measured variables:

- Energy flow
- Mass flow
- Corrected volume flow
- Corrected methane volume flow

Current input

The measured values are written from the automation system to the measuring device via the current input →  6.

HART protocol

The measured values are written from the automation system to the measuring device via the HART protocol. The pressure transmitter must support the following protocol-specific functions:

- HART protocol
- Burst mode



Output

Output signal

Current output

Current output 1	4-20 mA HART (passive)
Current output 2	4-20 mA (passive)
Resolution	< 1 µA
Damping	Adjustable: 0.0 to 999.9 s
Assignable measured variables	<ul style="list-style-type: none"> ▪ Volume flow ▪ Corrected volume flow ▪ Corrected methane volume flow ▪ Mass flow ▪ Energy flow ▪ Methane fraction ▪ Calorific value ▪ Wobbe index ▪ Temperature

Pulse/frequency/switch output

Function	Can be set to pulse, frequency or switch output
Version	Passive, open collector
Maximum input values	<ul style="list-style-type: none"> ▪ DC 35 V ▪ 50 mA  For information on the Ex connection values →  10
Voltage drop	<ul style="list-style-type: none"> ▪ For ≤ 2 mA: 2 V ▪ For 10 mA: 8 V
Residual current	≤ 0.05 mA
Pulse output	
Pulse width	Adjustable: 5 to 2 000 ms
Maximum pulse rate	100 Impulse/s
Pulse value	Adjustable
Assignable measured variables	<ul style="list-style-type: none"> ▪ Volume flow ▪ Corrected volume flow ▪ Corrected methane volume flow ▪ Mass flow ▪ Energy flow
Frequency output	
Output frequency	Adjustable: 0 to 1 000 Hz
Damping	Adjustable: 0 to 999 s
Pulse/pause ratio	1:1

Assignable measured variables	<ul style="list-style-type: none"> ■ Volume flow ■ Corrected volume flow ■ Corrected methane volume flow ■ Mass flow ■ Energy flow ■ Methane fraction ■ Calorific value ■ Wobbe index ■ Temperature
Switch output	
Switching behavior	Binary, conductive or non-conductive
Switching delay	Adjustable: 0 to 100 s
Number of switching cycles	Unlimited
Assignable functions	<ul style="list-style-type: none"> ■ Off ■ On ■ Diagnostic behavior ■ Limit value <ul style="list-style-type: none"> - Volume flow - Corrected volume flow - Corrected methane volume flow - Mass flow - Energy flow - Methane fraction - Calorific value - Wobbe index - Temperature - Totalizer 1 to 3 ■ Flow direction monitoring ■ Status <ul style="list-style-type: none"> Low flow cut off

Signal on alarm

Depending on the interface, failure information is displayed as follows:

Current output

4-20 mA

Failure mode	Selectable (as per NAMUR recommendation NE 43): <ul style="list-style-type: none"> ■ Minimum value: 3.6 mA ■ Maximum value: 22 mA ■ Defined value: 3.59 to 22.5 mA ■ Actual value ■ Last valid value
---------------------	---

HART

Device diagnostics	Device condition can be read out via HART Command 48
---------------------------	--

Pulse/frequency/switch output

Pulse output

Failure mode	Choose from: <ul style="list-style-type: none"> ■ Actual value ■ No pulses
---------------------	--

Frequency output

Failure mode	Choose from: <ul style="list-style-type: none"> ■ Actual value ■ 0 Hz ■ Defined value: 0 to 1250 Hz
---------------------	--

Switch output

Failure mode	Choose from: <ul style="list-style-type: none"> ■ Current status ■ Open ■ Closed
---------------------	---

Local display



Plain text display	With information on cause and remedial measures
Backlight	Additionally for device version with SD03 local display: red lighting indicates a device error.

 Status signal as per NAMUR recommendation NE 107

Operating tool

- Via digital communication:
 - HART protocol
- Via service interface

Plain text display	With information on cause and remedial measures
---------------------------	---

 Additional information on remote operation →  42

Load

Load for current output: 0 to 500 Ω, depending on the external supply voltage of the power supply unit

Calculation of the maximum load

Depending on the supply voltage of the power supply unit (U_S), the maximum load (R_B) including line resistance must be observed to ensure adequate terminal voltage at the device. In doing so, observe the minimum terminal voltage

- For $U_S = 16.0$ to 16.8 V: $R_B \leq (U_S - 16.0 \text{ V}): 0.0036 \text{ A}$
- For $U_S = 16.8$ to 23.0 V: $R_B \leq (U_S - 12.0 \text{ V}): 0.022 \text{ A}$
- For $U_S = 23.0$ to 30.0 V: $R_B \leq 500 \Omega$

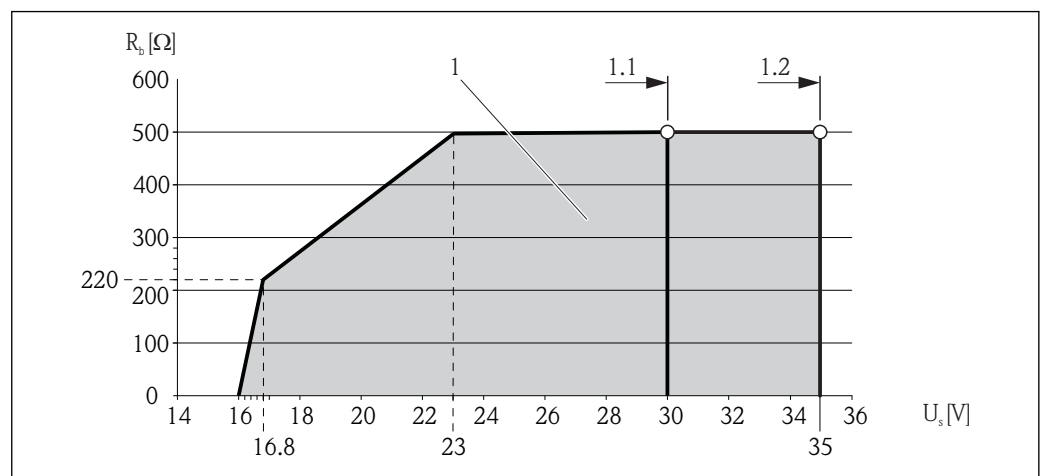

- 1 Operating range
- 1.1 For order code for "Output", option A "4-20 mA HART"/option B "4-20 mA HART, pulse/frequency/switch output" with Ex i and option C "4-20 mA HART + 4-20 mA analog"
- 1.2 For order code for "Output", option A "4-20 mA HART"/option B "4-20 mA HART, pulse/frequency/switch output" with non-Ex and Ex d

Sample calculationSupply voltage of the power supply unit: $U_S = 17.5 \text{ V}$ Maximum load: $R_B \leq (17.5 \text{ V} - 12.0 \text{ V}) : 0.022 \text{ A} = 250 \Omega$ **Ex connection data****Safety-related values***Type of protection Ex d*

Order code for "Output"	Output type	Safety-related values
Option A	4-20mA HART	$U_{\text{nom}} = \text{DC } 35 \text{ V}$ $U_{\text{max}} = 250 \text{ V}$
Option B	4-20mA HART	$U_{\text{nom}} = \text{DC } 35 \text{ V}$ $U_{\text{max}} = 250 \text{ V}$
	Pulse/frequency/switch output	$U_{\text{nom}} = \text{DC } 35 \text{ V}$ $U_{\text{max}} = 250 \text{ V}$ $P_{\text{max}} = 1 \text{ W}^{1)}$
Option C	4-20mA HART	$U_{\text{nom}} = \text{DC } 30 \text{ V}$
	4-20mA analog	$U_{\text{max}} = 250 \text{ V}$
Option D	4-20mA HART	$U_{\text{nom}} = \text{DC } 35 \text{ V}$ $U_{\text{max}} = 250 \text{ V}$
	Pulse/frequency/switch output	$U_{\text{nom}} = \text{DC } 35 \text{ V}$ $U_{\text{max}} = 250 \text{ V}$ $P_{\text{max}} = 1 \text{ W}^{1)}$
	4 to 20 mA current input	$U_{\text{nom}} = \text{DC } 35 \text{ V}$ $U_{\text{max}} = 250 \text{ V}$

1) Internal circuit limited by $R_i = 760.5 \Omega$ *Type of protection XP*

Order code for "Output"	Output type	Safety-related values
Option A	4-20mA HART	$U_{\text{nom}} = \text{DC } 35 \text{ V}$ $U_{\text{max}} = 250 \text{ V}$
Option B	4-20mA HART	$U_{\text{nom}} = \text{DC } 35 \text{ V}$ $U_{\text{max}} = 250 \text{ V}$
	Pulse/frequency/switch output	$U_{\text{nom}} = \text{DC } 35 \text{ V}$ $U_{\text{max}} = 250 \text{ V}$ $P_{\text{max}} = 1 \text{ W}^{1)}$
Option C	4-20mA HART	$U_{\text{nom}} = \text{DC } 30 \text{ V}$
	4-20mA analog	$U_{\text{max}} = 250 \text{ V}$
Option D	4-20mA HART	$U_{\text{nom}} = \text{DC } 35 \text{ V}$ $U_{\text{max}} = 250 \text{ V}$
	Pulse/frequency/switch output	$U_{\text{nom}} = \text{DC } 35 \text{ V}$ $U_{\text{max}} = 250 \text{ V}$ $P_{\text{max}} = 1 \text{ W}^{1)}$
	4 to 20 mA current input	$U_{\text{nom}} = \text{DC } 35 \text{ V}$ $U_{\text{max}} = 250 \text{ V}$

1) Internal circuit limited by $R_i = 760.5 \Omega$

Type of protection NI

Order code for "Output"	Output type	Safety-related values
Option A	4-20mA HART	$U_{nom} = DC 35 V$ $U_{max} = 250 V$
Option B	4-20mA HART	$U_{nom} = DC 35 V$ $U_{max} = 250 V$
	Pulse/frequency/switch output	$U_{nom} = DC 35 V$ $U_{max} = 250 V$ $P_{max} = 1 W^{1)}$
Option C	4-20mA HART	$U_{nom} = DC 30 V$ $U_{max} = 250 V$
	4-20mA analog	
Option D	4-20mA HART	$U_{nom} = DC 35 V$ $U_{max} = 250 V$
	Pulse/frequency/switch output	$U_{nom} = DC 35 V$ $U_{max} = 250 V$ $P_{max} = 1 W^{1)}$
	4 to 20 mA current input	$U_{nom} = DC 35 V$ $U_{max} = 250 V$

1) Internal circuit limited by $R_i = 760.5 \Omega$

Type of protection NIFW

Order code for "Output"	Output type	Safety-related values
Option A	4-20mA HART	$U_i = DC 35 V$ $I_i = n.a.$ $P_i = 1 W$ $L_i = 0 \mu H$ $C_i = 5 nF$
Option B	4-20mA HART	$U_i = DC 35 V$ $I_i = n.a.$ $P_i = 1 W$ $L_i = 0 \mu H$ $C_i = 5 nF$
	Pulse/frequency/switch output	$U_i = DC 35 V$ $I_i = n.a.$ $P_i = 1 W$ $L_i = 0 \mu H$ $C_i = 6 nF$
Option C	4-20mA HART	$U_i = DC 30 V$ $I_i = n.a.$ $P_i = 1 W$ $L_i = 0 \mu H$ $C_i = 30 nF$
	4-20mA analog	
Option D	4-20mA HART	$U_i = DC 35 V$ $I_i = n.a.$ $P_i = 1 W$ $L_i = 0 \mu H$ $C_i = 5 nF$

Order code for "Output"	Output type	Safety-related values
	Pulse/frequency/switch output	$U_i = \text{DC } 35 \text{ V}$ $I_i = \text{n.a.}$ $P_i = 1 \text{ W}$ $L_i = 0 \mu\text{H}$ $C_i = 6 \text{ nF}$
	4 to 20 mA current input	$U_i = \text{DC } 35 \text{ V}$ $I_i = \text{n.a.}$ $P_i = 1 \text{ W}$ $L_i = 0 \mu\text{H}$ $C_i = 5 \text{ nF}$

Intrinsically safe values

Type of protection *Ex ia*

Order code for "Output"	Output type	Intrinsically safe values
Option A	4-20mA HART	$U_i = \text{DC } 30 \text{ V}$ $I_i = 300 \text{ mA}$ $P_i = 1 \text{ W}$ $L_i = 0 \mu\text{H}$ $C_i = 5 \text{ nF}$
Option B	4-20mA HART	$U_i = \text{DC } 30 \text{ V}$ $I_i = 300 \text{ mA}$ $P_i = 1 \text{ W}$ $L_i = 0 \mu\text{H}$ $C_i = 5 \text{ nF}$
	Pulse/frequency/switch output	$U_i = \text{DC } 30 \text{ V}$ $I_i = 300 \text{ mA}$ $P_i = 1 \text{ W}$ $L_i = 0 \mu\text{H}$ $C_i = 6 \text{ nF}$
Option C	4-20mA HART	$U_i = \text{DC } 30 \text{ V}$ $I_i = 300 \text{ mA}$ $P_i = 1 \text{ W}$ $L_i = 0 \mu\text{H}$ $C_i = 30 \text{ nF}$
	4-20mA analog	
Option D	4-20mA HART	$U_i = \text{DC } 30 \text{ V}$ $I_i = 300 \text{ mA}$ $P_i = 1 \text{ W}$ $L_i = 0 \mu\text{H}$ $C_i = 5 \text{ nF}$
	Pulse/frequency/switch output	$U_i = \text{DC } 30 \text{ V}$ $I_i = 300 \text{ mA}$ $P_i = 1 \text{ W}$ $L_i = 0 \mu\text{H}$ $C_i = 6 \text{ nF}$
	4 to 20 mA current input	$U_i = \text{DC } 30 \text{ V}$ $I_i = 300 \text{ mA}$ $P_i = 1 \text{ W}$ $L_i = 0 \mu\text{H}$ $C_i = 5 \text{ nF}$

Type of protection IS

Order code for "Output"	Output type	Intrinsically safe values
Option A	4-20mA HART	U _i = DC 30 V I _i = 300 mA P _i = 1 W L _i = 0 μH C _i = 5 nF
Option B	4-20mA HART	U _i = DC 30 V I _i = 300 mA P _i = 1 W L _i = 0 μH C _i = 5 nF
	Pulse/frequency/switch output	U _i = DC 30 V I _i = 300 mA P _i = 1 W L _i = 0 μH C _i = 6 nF
Option C	4-20mA HART	U _i = DC 30 V I _i = 300 mA P _i = 1 W L _i = 0 μH C _i = 30 nF
	4-20mA analog	
Option D	4-20mA HART	U _i = DC 30 V I _i = 300 mA P _i = 1 W L _i = 0 μH C _i = 5 nF
	Pulse/frequency/switch output	U _i = DC 30 V I _i = 300 mA P _i = 1 W L _i = 0 μH C _i = 6 nF
	4 to 20 mA current input	U _i = DC 30 V I _i = 300 mA P _i = 1 W L _i = 0 μH C _i = 5 nF

Low flow cut off The switch points for low flow cut off are user-selectable.

Galvanic isolation All outputs are galvanically isolated from one another.

Protocol-specific data **HART**

Manufacturer ID	0x11
Device type ID	0x5A
HART protocol revision	7
Device description files (DTM, DD)	Information and files under: www.endress.com
HART load	<ul style="list-style-type: none"> ▪ Min. 250 Ω ▪ Max. 500 Ω

<p>Dynamic variables</p>	<p>Read out the dynamic variables: HART command 3 The measured variables can be freely assigned to the dynamic variables.</p> <p>Measured variables for PV (primary dynamic variable)</p> <ul style="list-style-type: none"> ▪ Volume flow ▪ Corrected volume flow ▪ Corrected methane volume flow ▪ Energy flow ▪ Methane fraction in % ▪ Calorific value ▪ Wobbe index ▪ Temperature ▪ Mass flow ▪ Sound velocity ▪ Flow velocity ▪ Acceptance rate ▪ Signal asymmetry ▪ Turbulence ▪ Signal to noise ratio ▪ Signal strength <p>Measured variables for SV, TV, QV (secondary, tertiary and quaternary dynamic variable)</p> <ul style="list-style-type: none"> ▪ Volume flow ▪ Corrected volume flow ▪ Corrected methane volume flow ▪ Energy flow ▪ Methane fraction in % ▪ Calorific value ▪ Wobbe index ▪ Temperature ▪ Totalizer 1 ▪ Totalizer 2 ▪ Totalizer 3 ▪ Mass flow ▪ Sound velocity ▪ Flow velocity ▪ Acceptance rate ▪ Signal asymmetry ▪ Turbulence ▪ Signal to noise ratio ▪ Signal strength
<p>Device variables</p>	<p>Read out the device variables: HART command 9 The device variables are permanently assigned.</p> <p>A maximum of 8 device variables can be transmitted:</p> <ul style="list-style-type: none"> ▪ 0 = volume flow ▪ 1 = corrected volume flow ▪ 2 = methane corrected volume flow ▪ 3 = energy flow ▪ 4 = methane fraction in % ▪ 5 = calorific value ▪ 6 = Wobbe index ▪ 7 = temperature ▪ 8 = totalizer 1 ▪ 9 = totalizer 2 ▪ 10 = totalizer 3 ▪ 11 = mass flow ▪ 12 = sound velocity ▪ 13 = flow velocity ▪ 14 = acceptance rate ▪ 15 = signal asymmetry ▪ 16 = turbulence ▪ 17 = signal to noise ratio ▪ 18 = signal strength

Power supply

Terminal assignment

Transmitter

Connection versions

<p style="text-align: right; font-size: small;">A0020738</p>	<p style="text-align: right; font-size: small;">A0020739</p>
<p><i>Maximum number of terminals</i> Terminals 1 to 6: Without integrated overvoltage protection</p>	<p><i>Maximum number of terminals for order code for "Accessory mounted", option NA "Overvoltage protection"</i></p> <ul style="list-style-type: none"> ■ Terminals 1 to 4: With integrated overvoltage protection ■ Terminals 5 to 6: Without integrated overvoltage protection
<p>1 Output 1 (passive): supply voltage and signal transmission 2 Output 2 (passive): supply voltage and signal transmission 3 Input (passive): supply voltage and signal transmission 4 Ground terminal for cable shield</p>	

Order code for "Output"	Terminal numbers					
	Output 1		Output 2		Input	
	1 (+)	2 (-)	3 (+)	4 (-)	5 (+)	6 (-)
Option A	4-20 mA HART (passive)		-		-	
Option B ¹⁾	4-20 mA HART (passive)		Pulse/frequency/switch output (passive)		-	
Option C ¹⁾	4-20 mA HART (passive)		4-20 mA analog (passive)		-	
Option D ^{1) 2)}	4-20 mA HART (passive)		Pulse/frequency/switch output (passive)		4-20 mA current input (passive)	

- 1) Output 1 must always be used; output 2 is optional.
 2) The integrated overvoltage protection is not used with option D: Terminals 5 and 6 (current input) are not protected against overvoltage.

Supply voltage



Transmitter

An external power supply is required for each output.



Order code for "Output"	Minimum terminal voltage	Maximum terminal voltage
Option A ^{1) 2)} : 4-20 mA HART	<ul style="list-style-type: none"> ■ For 4 mA: ≥ DC 16 V ■ For 20 mA: ≥ DC 12 V 	DC 35 V
Option B : 4-20 mA HART, pulse/frequency/switch output	<ul style="list-style-type: none"> ■ For 4 mA: ≥ DC 16 V ■ For 20 mA: ≥ DC 12 V 	DC 35 V

Order code for "Output"	Minimum terminal voltage	Maximum terminal voltage
Option C : 4-20 mA HART + 4-20 mA analog	<ul style="list-style-type: none"> ▪ For 4 mA: \geq DC 16 V ▪ For 20 mA: \geq DC 12 V 	DC 30 V
Option D: 4-20 mA HART, pulse/frequency/switch output, 4-20 mA current input ³⁾	\geq DC 12 V	DC 35 V

- 1) External supply voltage of the power supply unit with load.
- 2) For device versions with SD03 local display: The terminal voltage must be increased by DC 2 V if backlighting is used.
- 3) Voltage drop 2.2 to 3 V for 3.59 to 22 mA

 For information about the load see →  9

 Various power supply units can be ordered from Endress+Hauser: see "Accessories" section →  48

 For information on the Ex connection values →  10

Power consumption

Transmitter

Order code for "Output"	Maximum power consumption
Option A: 4-20 mA HART	770 mW
Option B: 4-20 mA HART, pulse/frequency/switch output	<ul style="list-style-type: none"> ▪ Operation with output 1: 770 mW ▪ Operation with output 1 and 2: 2 770 mW
Option C: 4-20 mA HART + 4-20 mA analog	<ul style="list-style-type: none"> ▪ Operation with output 1: 660 mW ▪ Operation with output 1 and 2: 1 320 mW
Option D: 4-20 mA HART, pulse/frequency/switch output, 4-20 mA current input	<ul style="list-style-type: none"> ▪ Operation with output 1: 770 mW ▪ Operation with output 1 and 2: 2 770 mW ▪ Operation with output 1 and input: 840 mW ▪ Operation with output 1, 2 and input: 2 840 mW

 For information on the Ex connection values →  10

Current consumption

Current output

For every 4-20 mA or 4-20 mA HART current output: 3.6 to 22.5 mA

 If the option **Defined value** is selected in the **Failure mode** parameter : 3.59 to 22.5 mA

Current input

3.59 to 22.5 mA

 Internal current limiting: max. 26 mA

Power supply failure

- Totalizers stop at the last value measured.
- Configuration is retained in the device memory (HistoROM).
- Error messages (incl. total operated hours) are stored.

Electrical connection

Connecting the transmitter

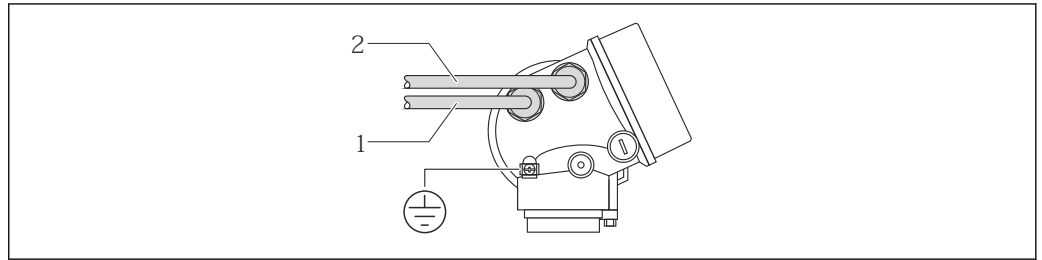

A0015510

- 1 Cable entry for output 1
- 2 Cable entry for output 2

Connection examples

Current output 4-20 mA HART

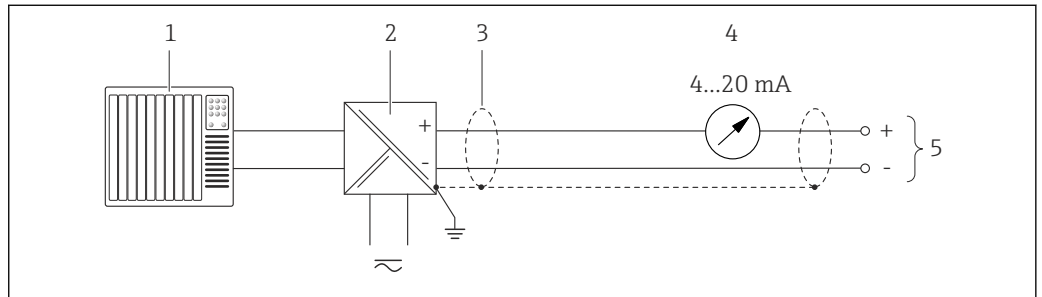

A0015511

2 Connection example for 4-20 mA HART current output (passive)

- 1 Automation system with current input (e.g. PLC)
- 2 Active barrier for power supply with integrated resistor for HART communication ($\geq 250 \Omega$) (e.g. RN221N)
Connection for HART operating devices → 42
Observe the maximum load → 9
- 3 Cable shield, observe cable specifications
- 4 Analog display unit: observe maximum load → 9
- 5 Transmitter

Current output 4-20 mA

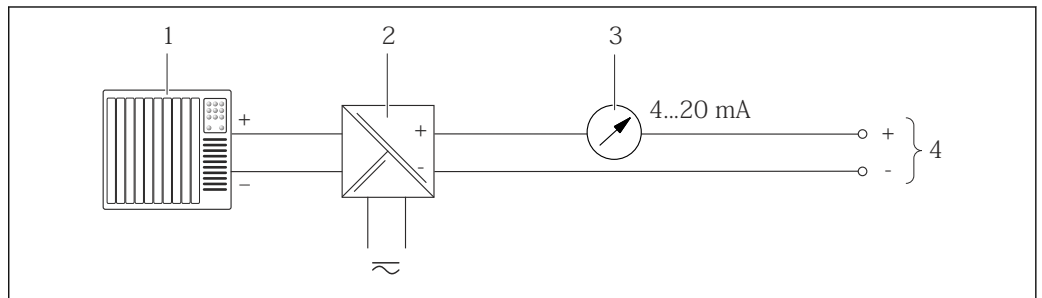

A0015512

3 Connection example for 4-20 mA current output (passive)

- 1 Automation system with current input (e.g. PLC)
- 2 Active barrier for power supply (e.g. RN221N)
- 3 Analog display unit: observe maximum load → 9
- 4 Transmitter

Pulse/frequency output

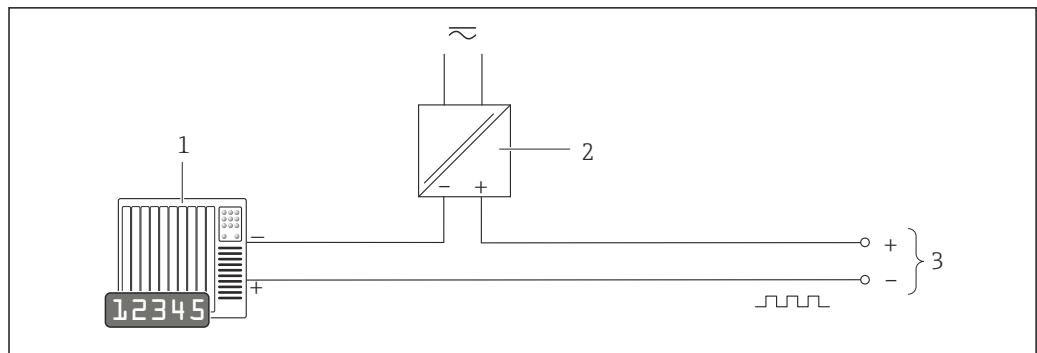

A0016801

4 Connection example for pulse/frequency output (passive)

- 1 Automation system with pulse/frequency input (e.g. PLC)
- 2 Power supply
- 3 Transmitter: observe input values

Switch output

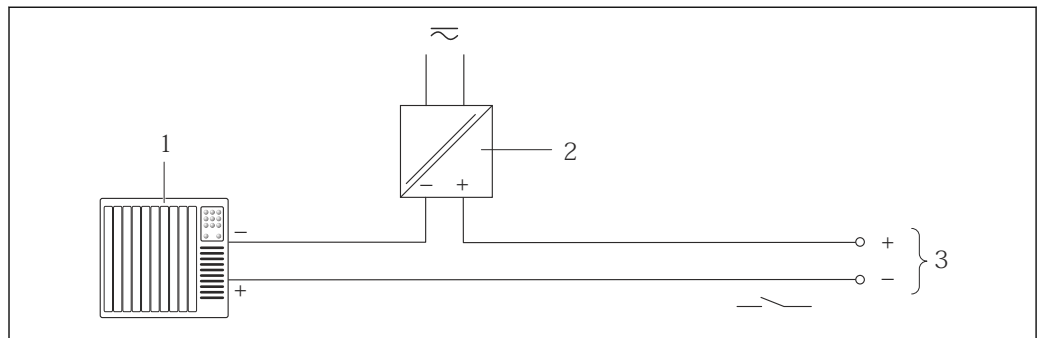

A0016802

5 Connection example for switch output (passive)

- 1 Automation system with switch input (e.g. PLC)
- 2 Power supply
- 3 Transmitter: observe input values

Current input

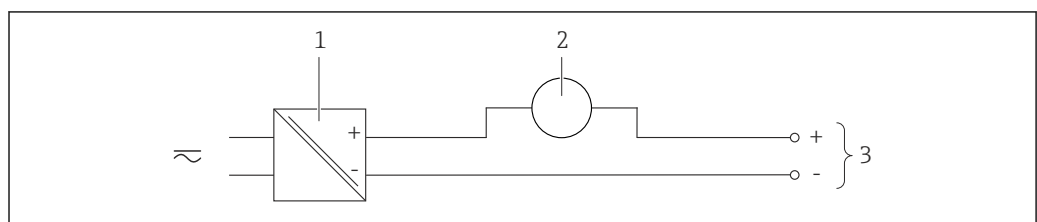

A0020741

6 Connection example for 4-20 mA current input

- 1 Power supply
- 2 External measuring device (for capturing the pressure)
- 3 Transmitter: observe input values → 6

HART input

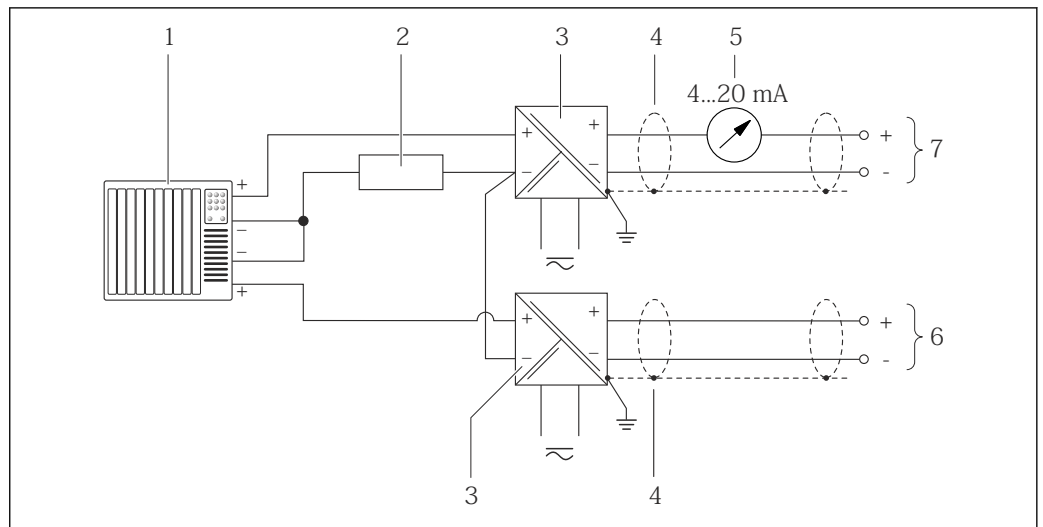

A0016029

7 Connection example for HART input with a common negative

- 1 Automation system with HART output (e.g. PLC)
- 2 Resistor for HART communication ($\geq 250 \Omega$): observe maximum load \rightarrow 9
- 3 Active barrier for power supply (e.g. RN221N)
- 4 Cable shield, observe cable specifications
- 5 Analog display unit: observe maximum load \rightarrow 9
- 6 Pressure transmitter (e.g. Cerabar M, Cerabar S): see requirements
- 7 Transmitter

Potential equalization

Requirements

No special measures for potential equalization are required.



For devices intended for use in hazardous locations, please observe the guidelines in the Ex documentation (XA).

Terminals

- For device version without integrated overvoltage protection: plug-in spring terminals for wire cross-sections 0.5 to 2.5 mm² (20 to 14 AWG)
- For device version with integrated overvoltage protection: screw terminals for wire cross-sections 0.2 to 2.5 mm² (24 to 14 AWG)

Cable entries

- Cable gland (not for Ex d): M20 × 1.5 with cable ϕ 6 to 12 mm (0.24 to 0.47 in)
- Thread for cable entry:
 - For non-Ex and Ex: NPT 1/2"
 - For non-Ex and Ex (not for CSA Ex d/XP): G 1/2"
 - For Ex d: M20 × 1.5

Cable specification

Permitted temperature range

- -40 °C (-40 °F) to +80 °C (+176 °F)
- Minimum requirement: cable temperature range \geq ambient temperature +20 K

Signal cable

Current output

- For 4-20 mA: standard installation cable is sufficient.
- For 4-20 mA HART: Shielded cable recommended. Observe grounding concept of the plant.

Pulse/frequency/switch output

Standard installation cable is sufficient.

Current input

Standard installation cable is sufficient.

Overvoltage protection

The device can be ordered with integrated overvoltage protection for diverse approvals:
Order code for "Accessory mounted", option NA "Overvoltage protection"

Input voltage range	Values correspond to supply voltage specifications ¹⁾
Resistance per channel	2 · 0.5 Ω max
DC sparkover voltage	400 to 700 V
Trip surge voltage	< 800 V
Capacitance at 1 MHz	< 1.5 pF
Nominal discharge current (8/20 μs)	10 kA
Temperature range	-40 to +85 °C (-40 to +185 °F)



1) The voltage is reduced by the amount of the internal resistance $I_{min} \cdot R_i$

 Depending on the temperature class, restrictions apply to the ambient temperature for device versions with overvoltage protection →  25

Performance characteristics

Reference operating conditions

- Error limits following ISO/DIS 11631
- Calibration gas: air
- Temperature regulated to 24 ± 0.5 °C (75.2 ± 0.9 °F) under atmospheric pressure
- Humidity regulated to <40% RH
- Accuracy based on accredited calibration rigs that are traced to ISO 17025.

 To calculate the measuring range, use the *Applicator* sizing tool →  48

Maximum measured error

o.r. = of reading; o.f.s. = of full scale value; abs. = absolute; T = medium temperature

Volume flow

Standard Order code for "Calibration flow", option 1 "Operable flow range 30 : 1"	<ul style="list-style-type: none"> ▪ ± 1.5 % o.r. for 3 to 30 m/s (9.84 to 98.4 ft/s) ▪ ± 3 % o.r. for 1 to 3 m/s (3.28 to 9.84 ft/s)
Optional Order code for "Calibration flow", option 2 "Operable flow range 100 : 1"	<ul style="list-style-type: none"> ▪ ± 0.1 % o.f.s. for 0.3 to 1 m/s (0.98 to 3.28 ft/s) ▪ ± 1.5 % o.r. for 1 to 30 m/s (3.28 to 98.4 ft/s)

Methane

± 2 % o.f.s. = ± 2 % abs.

Temperature

± 0.6 % $\pm 0.005 \cdot T$ °C (± 0.9 °F $\pm 0.005 \cdot (T - 32)$ °F)

Example for max. measured error (volume flow)

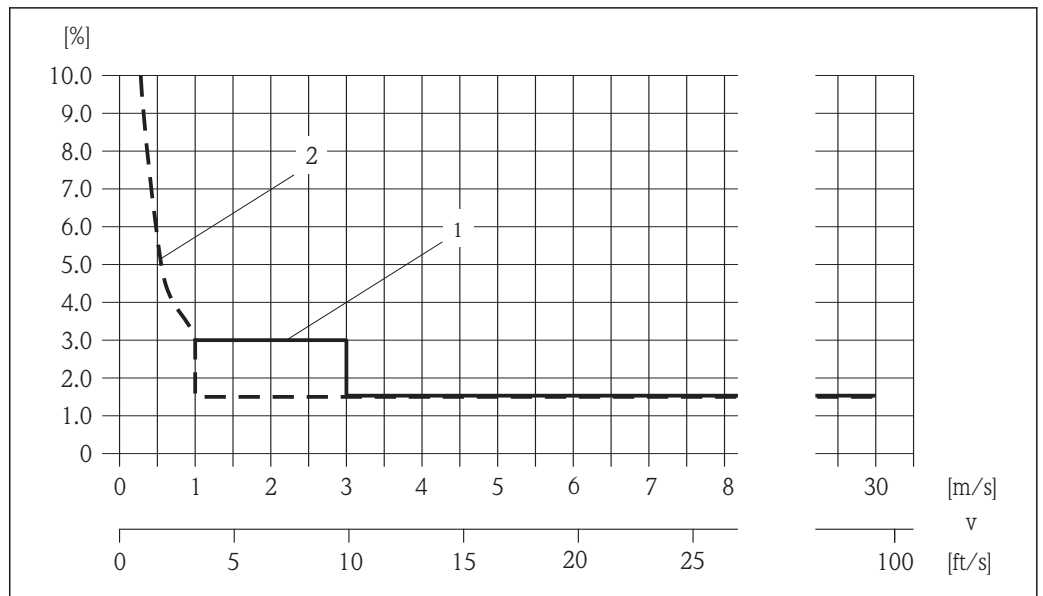

8 Example for max. measured error (volume flow) in % o.r.

- 1 Standard (order code for "Calibration flow", option 1 "Operable flow range 30 : 1")
- 2 Optional (order code for "Calibration flow", option 2 "Operable flow range 100 : 1")

Accuracy of outputs

o.r. = of reading

The outputs have the following base accuracy specifications.

Current output

Accuracy	±10 µA
-----------------	--------

Pulse/frequency output

Accuracy	Max. ±100 ppm o.r.
-----------------	--------------------

Repeatability

o.r. = of reading; o.f.s. = of full scale value; abs. = absolute; T = medium temperature

Volume flow

±0.5 % o.r.

Methane

±0.5 % o.f.s. = ±0.5 % abs.

Temperature

±0.3 °C ± 0.0025 × T °C (±0.45 °F ± 0.0025 × (T - 32) °F)

Response time

- The response time depends on the configuration (damping).
- Response time in the event of erratic changes in the flow: after 1 000 ms 95% of the full scale value.

Influence of ambient temperature

o.r. = of reading

Current output

Additional error, in relation to the span of 16 mA:

Temperature coefficient at zero point (4 mA)	0.02 %/10 K
Temperature coefficient with span (20 mA)	0.05 %/10 K

Pulse/frequency output

Temperature coefficient	Max. ±100 ppm o.r.
-------------------------	--------------------

Installation

No special measures such as supports are necessary. External forces are absorbed by the construction of the device.

Mounting location

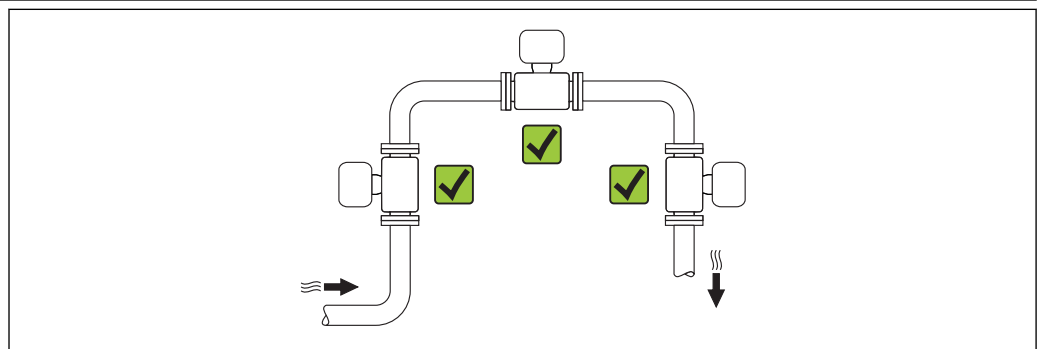

A0015543

Orientation

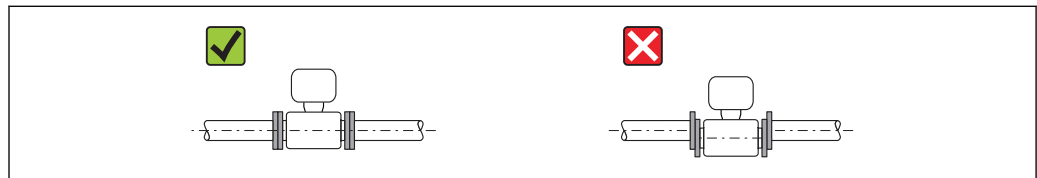

The direction of the arrow on the sensor helps you to install the sensor according to the flow direction (direction of medium flow through the piping).

-  Install the measuring device in a parallel plane free of external mechanical stress.
- The internal diameter of the pipe must match the internal diameter of the sensor .

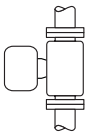
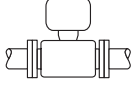

A0015895

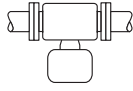
Orientation		Compact version
A	Vertical orientation	 A0015545 ✓✓
B	Horizontal orientation, transmitter head up *	 A0015589 ✓✓

Orientation		Compact version	
C	Horizontal orientation, transmitter head down *	 A0015590	<input checked="" type="checkbox"/>
D	Horizontal orientation, transmitter head at side	 A0015592	<input type="checkbox"/>

 * A maximum deviation of only $\pm 3^\circ$ is permitted for the horizontal alignment of the converters.

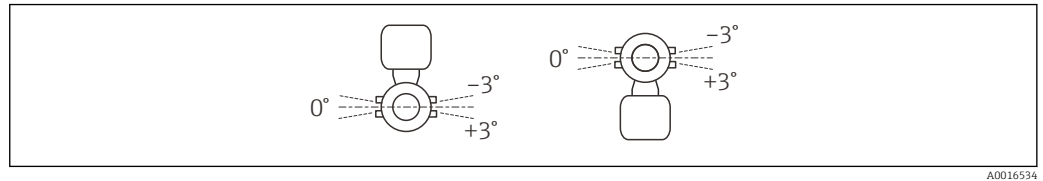

Inlet and outlet runs

If possible, the sensor should be installed upstream from valves, T-pieces, elbows etc. To attain the specified level of accuracy of the measuring device, the below mentioned inlet and outlet runs must be maintained at minimum. If there are several flow disturbances present, the longest specified inlet run must be maintained.

Single-path version: DN 50 (2"), DN 80 (3")

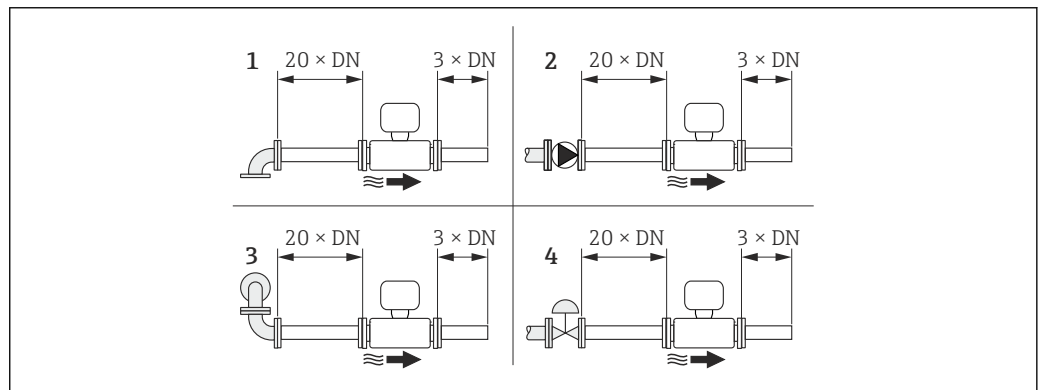

 9 Single-path version: minimum inlet and outlet runs with various flow obstructions

- 1 90° elbow or T-section
- 2 Pump
- 3 2 × 90° elbow, 3-dimensional
- 4 Control valve

Two-path version: DN 100 to 200 (4 to 8")

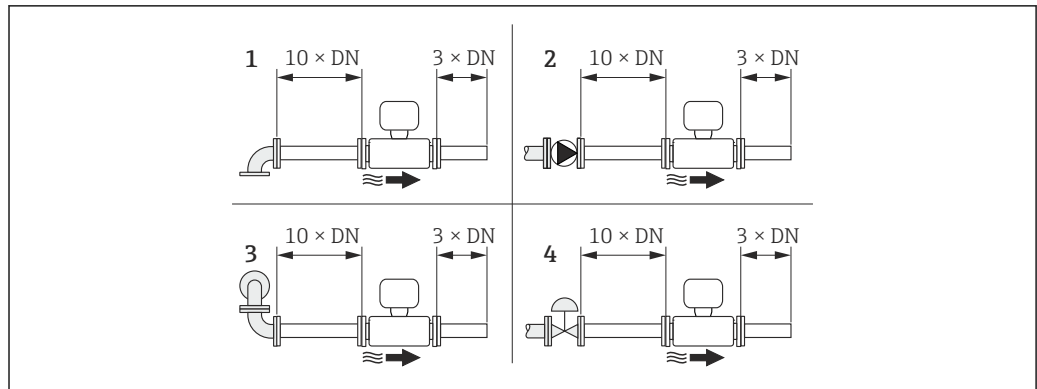

A0015553

10 Two-path version: minimum inlet and outlet runs with various flow obstructions

- 1 90° elbow or T-section
- 2 Pump
- 3 2 × 90° elbow, 3-dimensional
- 4 Control valve

Outlet runs when installing external devices

If installing an external device, observe the specified distance.

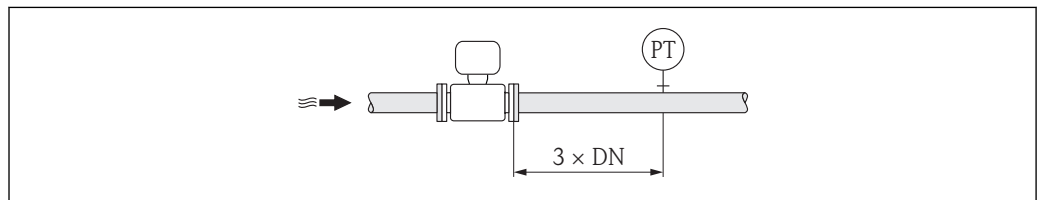

A0015901

PT Pressure transmitter

Special mounting instructions

Flow conditioner

If the inlet runs cannot be observed, the use of a flow conditioner is recommended. This makes the following shorter inlet runs possible:

Single-path version	Two-path version
10 × DN	5 × DN

The flow conditioner should divide the inlet run available into a ratio of around 20 : 80. Example of an inlet run of 10 × DN:

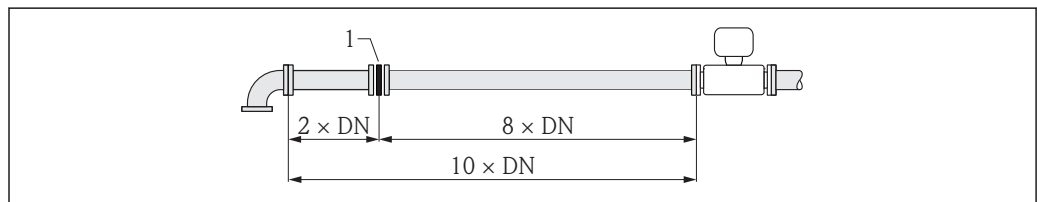

A0015562

1 Flow conditioner

Pressure loss

The pressure loss for flow conditioners is calculated as follows:

$$\Delta p [\text{mbar}] = 0.0085 \cdot \rho [\text{kg/m}^3] \cdot v^2 [\text{m/s}]$$

Example for biogas

$p = 1040 \text{ mbar abs.}$

$\rho = 1.0432 \text{ kg/m}^3$ with $t = 54 \text{ }^\circ\text{C}$ (129 °F)

$v = 7 \text{ m/s}$

$\Delta p = 0.0085 \cdot 1.0432 \text{ kg/m}^3 \cdot 49 \text{ m/s} = 0.434 \text{ mbar}$

abs.: absolute

ρ : density of the process medium



v: average flow velocity

Environment

Ambient temperature range

Transmitter	-40 to +60 °C (-40 to +140 °F)
Local display	-20 to +60 °C (-4 to +140 °F), the readability of the display may be impaired at temperatures outside the temperature range.
Sensor	<ul style="list-style-type: none"> ■ Flange material carbon steel: -10 to +60 °C (+14 to +140 °F) ■ Flange material stainless steel: -40 to +60 °C (-40 to +140 °F) ■ Version without flange: -40 to +60 °C (-40 to +140 °F)

- ▶ If operating outdoors:
Avoid direct sunlight, particularly in warm climatic regions.

 Weather protection covers can be ordered from Endress+Hauser: see "Accessories" section
→  46

Temperature tables

The following interdependencies between the permitted ambient and fluid temperatures apply when operating the device in hazardous areas:

The following applies for installations with overvoltage protection in conjunction with approval code BJ or IJ: $T_a = T_a - 2 \text{ }^\circ\text{C}$ ($T_a = T_a - 3.6 \text{ }^\circ\text{F}$)

Order code for "Output", option A "4-20mA HART"

Ex ia, Ex d, cCSA_{US} IS, cCSA_{US} XP, cCSA_{US} NI

SI units

Nominal diameter [mm]	T _a [°C]	T6 [85 °C]	T5 [100 °C]	T4 [135 °C]	T3 [200 °C]	T2 [300 °C]	T1 [450 °C]
50 to 200	40	60	80	80	80	80	80
50 to 200	50	-	80	80	80	80	80
50 to 200	60	-	80	80	80	80	80

US units

Nominal diameter [in]	T _a [°F]	T6 [185 °F]	T5 [212 °F]	T4 [275 °F]	T3 [392 °F]	T2 [572 °F]	T1 [842 °F]
2 to 8	104	140	176	176	176	176	176
2 to 8	122	-	176	176	176	176	176
2 to 8	140	-	176	176	176	176	176

Order code for "Output", option B "4-20mA HART, pulse/frequency/switch output"

Ex ia, Ex d, cCSA_{US} IS, cCSA_{US} XP, cCSA_{US} NI*SI units*

Nominal diameter [mm]	T _a [°C]	T6 [85 °C]	T5 [100 °C]	T4 [135 °C]	T3 [200 °C]	T2 [300 °C]	T1 [450 °C]
50 to 200	40	- ¹⁾	80	80	80	80	80
50 to 200	50	-	60 ²⁾	80	80	80	80
50 to 200	60	-	-	80	80	80	80

1) T_a = 60 °C for pulse/frequency/switch output P_i ≤ 0.85 W2) T_a = 80 °C for pulse/frequency/switch output P_i ≤ 0.85 W*US units*

Nominal diameter [in]	T _a [°F]	T6 [185 °F]	T5 [212 °F]	T4 [275 °F]	T3 [392 °F]	T2 [572 °F]	T1 [842 °F]
2 to 8	104	- ¹⁾	176	176	176	176	176
2 to 8	122	-	140 ²⁾	176	176	176	176
2 to 8	140	-	-	176	176	176	176

1) T_a = 140 °F for pulse/frequency/switch output P_i ≤ 0.85 W2) T_a = 176 °F for pulse/frequency/switch output P_i ≤ 0.85 W**Order code for "Output", option C "4-20mA HART, 4-20mA analog"**Ex ia, Ex d, cCSA_{US} IS, cCSA_{US} XP, cCSA_{US} NI*SI units*

Nominal diameter [mm]	T _a [°C]	T6 [85 °C]	T5 [100 °C]	T4 [135 °C]	T3 [200 °C]	T2 [300 °C]	T1 [450 °C]
50 to 200	40	60	80	80	80	80	80
50 to 200	50	-	80	80	80	80	80
50 to 200	60	-	55	80	80	80	80

US units

Nominal diameter [in]	T _a [°F]	T6 [185 °F]	T5 [212 °F]	T4 [275 °F]	T3 [392 °F]	T2 [572 °F]	T1 [842 °F]
2 to 8	104	140	176	176	176	176	176
2 to 8	122	-	176	176	176	176	176
2 to 8	140	-	131	176	176	176	176

Order code for "Output", option D "4-20mA HART, PFS output; 4-20 mA input"

Ex ia, Ex d, cCSA_{US} IS, cCSA_{US} XP, cCSA_{US} NI

SI units

Nominal diameter [mm]	T _a ¹⁾ [°C]	T6 [85 °C]	T5 [100 °C]	T4 [135 °C]	T3 [200 °C]	T2 [300 °C]	T1 [450 °C]
50 to 200	35	60	80	80	80	80	80
50 to 200	50	-	80	80	80	80	80
50 to 200	60	-	-	80	80	80	80

1) The following applies for installations with overvoltage protection in conjunction with temperature class T5, T6 and approval options BA, BB, BD, BH, BJ, B2, IA, IB, ID, IH, IJ, I4, C2: T_a = T_a - 2 °C

US units

Nominal diameter [in]	T _a ¹⁾ [°F]	T6 [185 °F]	T5 [212 °F]	T4 [275 °F]	T3 [392 °F]	T2 [572 °F]	T1 [842 °F]
2 to 8	95	140	176	176	176	176	176
2 to 8	122	-	176	176	176	176	176
2 to 8	140	-	-	176	176	176	176

1) The following applies for installations with overvoltage protection in conjunction with temperature class T5, T6 and approval options BA, BB, BD, BH, BJ, B2, IA, IB, ID, IH, IJ, I4, C2: T_a = T_a - 35.6 °F

Storage temperature

All components apart from the display modules:
-40 to +80 °C (-40 to +176 °F), preferably at +20 °C (+68 °F)

Display modules

-40 to +80 °C (-40 to +176 °F)

Degree of protection

Transmitter

- As standard: IP66/67, type 4X enclosure
- When housing is open: IP20, type 1 enclosure
- Display module: IP20, type 1 enclosure

Sensor

IP66/67, type 4X enclosure

Shock resistance

In accordance with EN 60721-3-4

Vibration resistance

Class 4M4, in accordance with EN 60721-3-4

Electromagnetic compatibility (EMC)

- As per IEC/EN 61326 and NAMUR Recommendation 21 (NE 21)
- Complies with emission limits for industry as per EN 55011



For details, refer to the Declaration of Conformity.

Process

Medium temperature range

Sensor

0 to +80 °C (+32 to +176 °F)

Pressure-temperature ratings

The following pressure-temperature ratings refer to the entire device and not just the process connection.

Flange connection according to EN 1092-1 (DIN 2501)

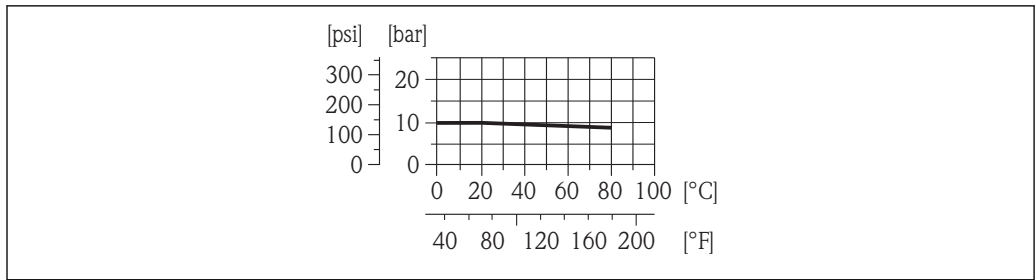

A0015905

11 With lap joint flange, stamped plate PN 10, material 1.4301 (304) (DN 50 to 200 / 2 to 8")

Flange connection according to EN 1092-1 (DIN 2501)

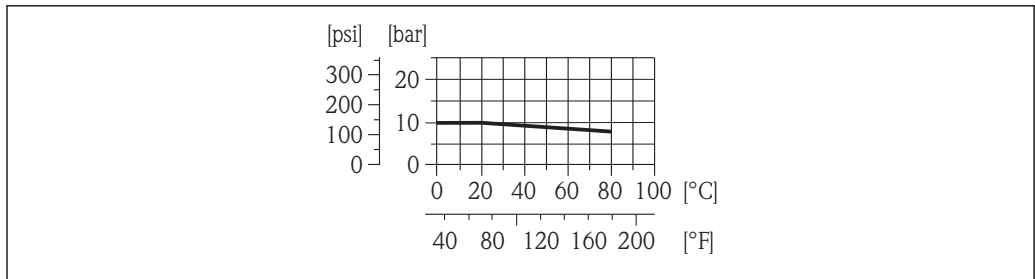

A0015906

12 With lap joint flange PN 10, material 1.4306 (304L) (DN 200 / 8")

Flange connection according to EN 1092-1 (DIN 2501)

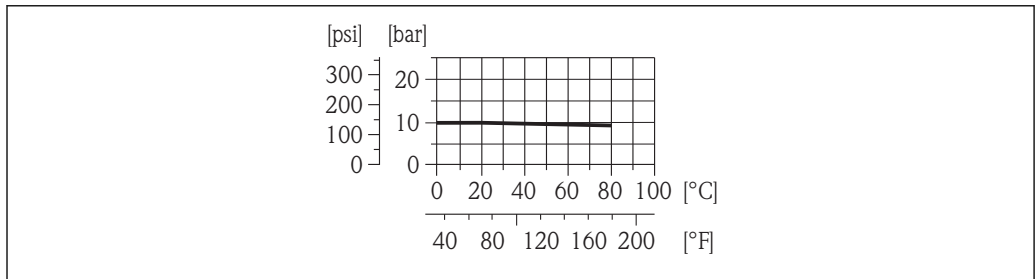

A0015932

13 With lap joint flange PN 10/16, materials S235JR (DN 50 to 200 / 2 to 8") and 1.4306 (304L) (DN 50 to 150 / 2 to 6"); With lap joint flange, stamped plate PN 10, material S235JR (DN 50 to 200 / 2 to 8")

Flange connection according to ASME B16.5

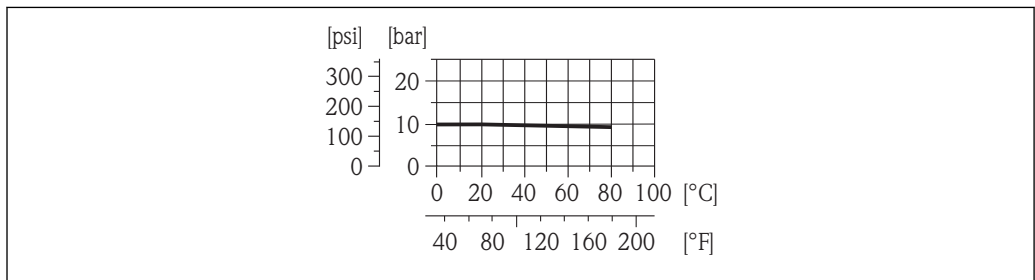



A0015568

14 With lap joint flange Class 150, materials 1.4404 (316L) and A105 (DN 50 to 200 / 2 to 8")

Flow limit

Select the nominal diameter by optimizing between the required flow range and permissible pressure loss.

 For an overview of the measuring range full scale values, see the "Measuring range" section
→  6

- The minimum recommended full scale value is approx. 1/20 of the maximum full scale value.
- In most applications, 10 to 50 % of the maximum full scale value can be considered ideal.

Pressure loss There is no pressure loss.

System pressure **Sensor**
Max. 10 bar (145 psi)

Thermal insulation For optimum temperature and methane fraction measurement (order characteristic for "Sensor version", option 2 "Volume flow + Biogas analysis"), make sure that heat is neither lost nor applied to the sensor. Thermal insulation can ensure that such heat transfer does not take place.

Thermal insulation is particularly recommended in situations where there is a large difference between the process temperature and the ambient temperature. This can result in heat convection errors during temperature measurement. A further factor which can lead to measurement errors due to heat convection is a low flow velocity.

Mechanical construction

Dimensions in SI units

Compact version

Order code for "Housing", options C "GT20 two-chamber, aluminum coated", S "GT18 two-chamber, stainless steel"

Lap joint flange; lap joint flange, stamped plate

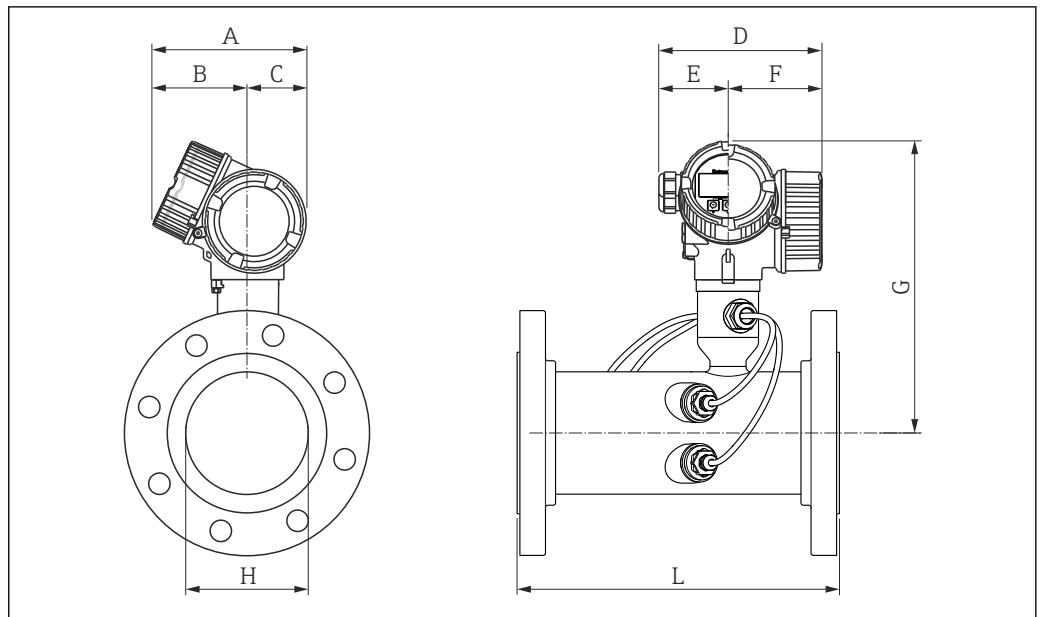

A0015456

DN [mm]	A [mm]	B ¹⁾ [mm]	C [mm]	D ²⁾ [mm]	E [mm]	F ²⁾ [mm]	G ³⁾ [mm]	Ø H [mm]	L [mm]
50	162	102	60	165	75	90	254	56.3	250
80	162	102	60	165	75	90	268	84.9	300
100	162	102	60	165	75	90	281	110.3	300

DN [mm]	A [mm]	B ¹⁾ [mm]	C [mm]	D ²⁾ [mm]	E [mm]	F ²⁾ [mm]	G ³⁾ [mm]	∅ H [mm]	L [mm]
150	162	102	60	165	75	90	308	164.3	350
200	162	102	60	165	75	90	334	213.9	400

- 1) For version without local display: values - 7 mm
- 2) For version with overvoltage protection (OVP): values + 8 mm
- 3) For version without local display: values - 10 mm

Without flange

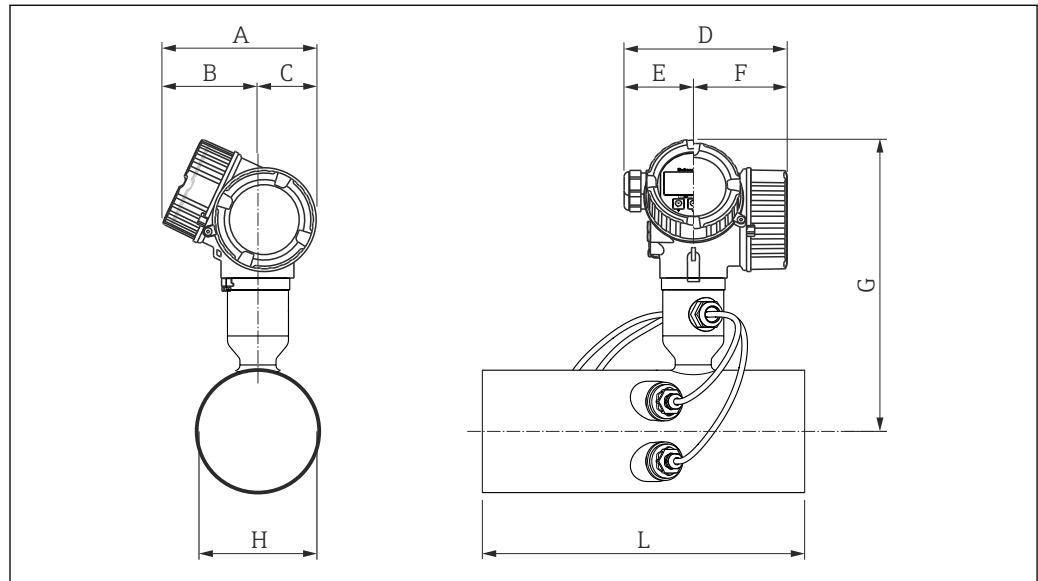

A0016233

DN [mm]	A [mm]	B ¹⁾ [mm]	C [mm]	D ²⁾ [mm]	E [mm]	F ²⁾ [mm]	G ³⁾ [mm]	∅ H [mm]	L [mm]
50	162	102	60	165	75	90	254	56.3	282.5
80	162	102	60	165	75	90	268	84.9	336.5
100	162	102	60	165	75	90	281	110.3	338.0
150	162	102	60	165	75	90	308	164.3	394.0
200	162	102	60	165	75	90	334	213.9	447.0

- 1) For version without local display: values - 7 mm
- 2) For version with overvoltage protection (OVP): values + 8 mm
- 3) Version without local display: values - 10 mm

Lap joint flange

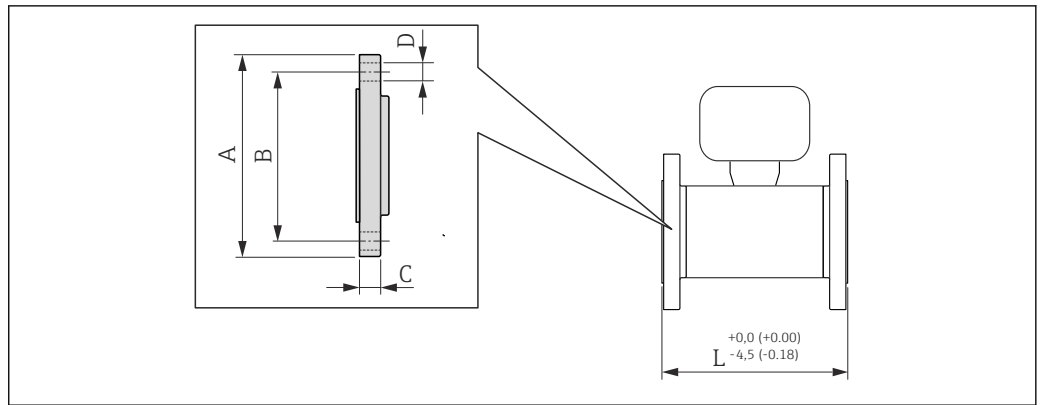

A0015457

15 mm (in)

Lap joint flange according to EN 1092-1 (DIN 2501): PN 10

1.4301 (304L): order code for "Process connection", option D23
 S235JR: order code for "Process connection", option D21

Lap joint flange according to EN 1092-1 (DIN 2501): PN 16

1.4306 (304L): order code for "Process connection", option D34
 S235JR: order code for "Process connection", option D32

DN [mm]	A [mm]	B [mm]	C [mm]	∅ D [mm]	L [mm]
50	165	125	22	4 × 18	250
80	200	160	22	8 × 18	300
100	220	180	24	8 × 18	300
150	285	240	26	8 × 22	350

Lap joint flange according to EN 1092-1 (DIN 2501): PN 10

1.4306 (304L): order code for "Process connection", option D24
 S235JR: order code for "Process connection", option D22

DN [mm]	A [mm]	B [mm]	C [mm]	∅ D [mm]	L [mm]
200	340	295	27	8 × 22	400

Lap joint flange according to ASME B16.5: Class 150

1.4404 (316L): order code for "Process connection", option A14
 A105: order code for "Process connection", option A12

DN [mm]	A [mm]	B [mm]	C [mm]	∅ D [mm]	L [mm]
50	152.4	120.7	21.1	4 × 19.1	250
80	190.5	152.4	25.9	4 × 19.1	300
100	228.6	190.5	25.9	8 × 19.1	300
150	279.4	241.3	27.4	8 × 22.4	350
200	342.9	298.5	31.0	8 × 22.4	400

Lap joint flange, stamped plate

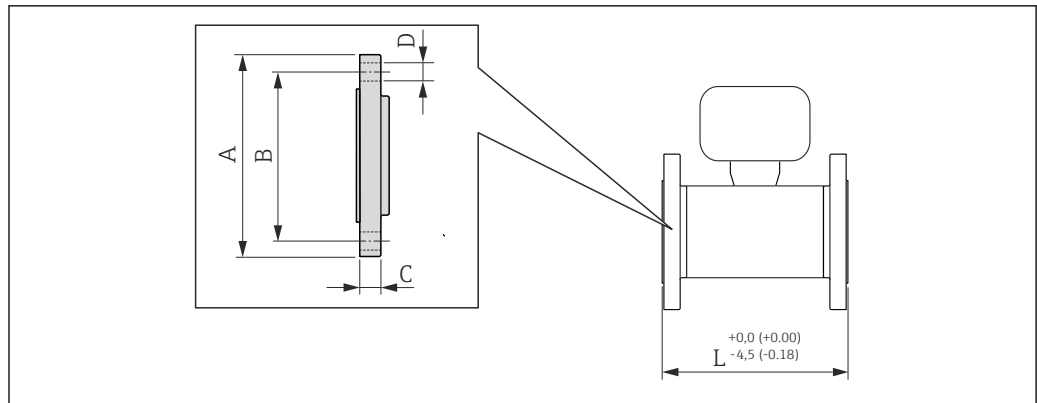

A0015457

16 mm (in)

Lap joint flange, stamped plate according to EN 1092-1 (DIN 2501): PN 10

1.4301 (304): order code for "Process connection", option D23

S235JR: order code for "Process connection", option D21

DN [mm]	A [mm]	B [mm]	C [mm]	∅ D [mm]	L [mm]
50	165	125	22	4 × 17.5	250
80	200	160	25	8 × 17.5	300
100	220	180	26	8 × 17.5	300
150	285	240	29	8 × 21.5	350
200	340	295	34	8 × 21.5	400

Accessories

Replacement tool

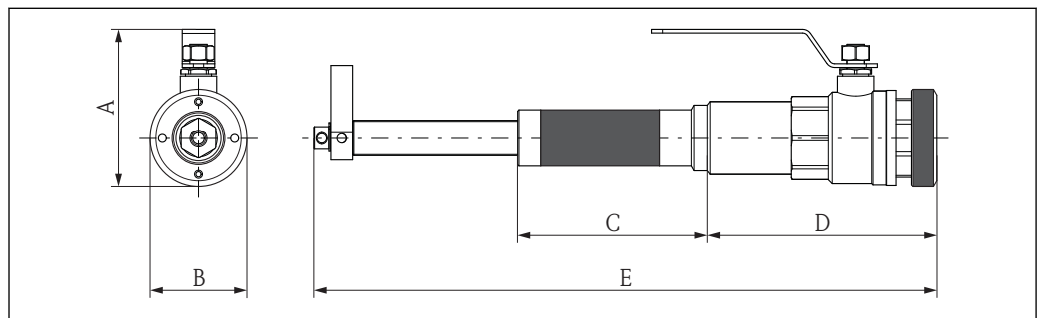

A0016020

Replacement tool

Order code for "Accessory enclosed", option PS

A [mm]	∅ B [mm]	C [mm]	D [mm]	E [mm]
108	67	131	159	330 to 430

Flow conditioner

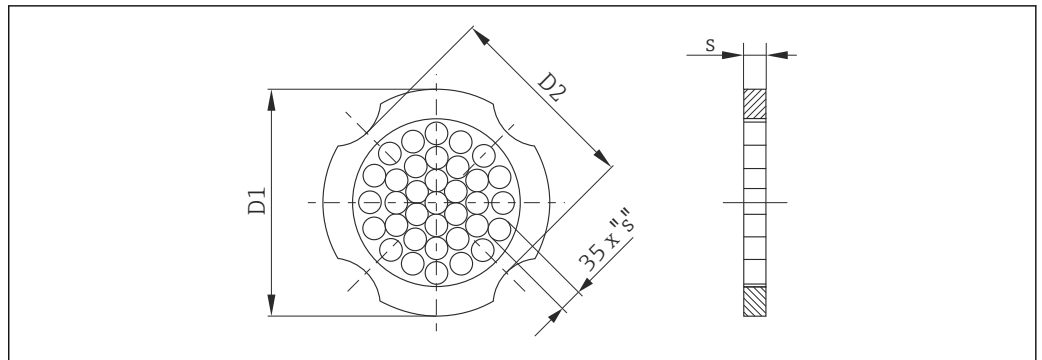

A0001941

Flow conditioner according to EN 1092-1 (DIN 2501): PN 10/16
 Order code for "Accessory enclosed", option PF

DN [mm]	Pressure rating	Centering diameter [mm]	D1 ¹⁾ / D2 ²⁾	s [mm]
50	PN 10/16	110.0	D2	6.80
80	PN 10/16	145.3	D2	10.1
100	PN 10/16	165.3	D2	13.3
150	PN 10/16	221.0	D2	20.0
200	PN 10	274.0	D1	26.3

- 1) The flow conditioner is fitted at the outer diameter between the bolts.
- 2) The flow conditioner is fitted at the indentations between the bolts.

Flow conditioner according to ASME B16.5: Class 150
 Order code for "Accessory enclosed", option PF

DN [mm]	Pressure rating	Centering diameter [mm]	D1 ¹⁾ / D2 ²⁾	s [mm]
50	Class 150	104.0	D2	6.80
80	Class 150	138.4	D1	10.1
100	Class 150	176.5	D2	13.3
150	Class 150	223.5	D1	20.0
200	Class 150	274.0	D2	26.3

- 1) The flow conditioner is fitted at the outer diameter between the bolts.
- 2) The flow conditioner is fitted at the indentations between the bolts.

Dimensions in US units

Compact version

Order code for "Housing", options C "GT20 two-chamber, aluminum coated", S "GT18 two-chamber, stainless steel"

Lap joint flange; lap joint flange, stamped plate

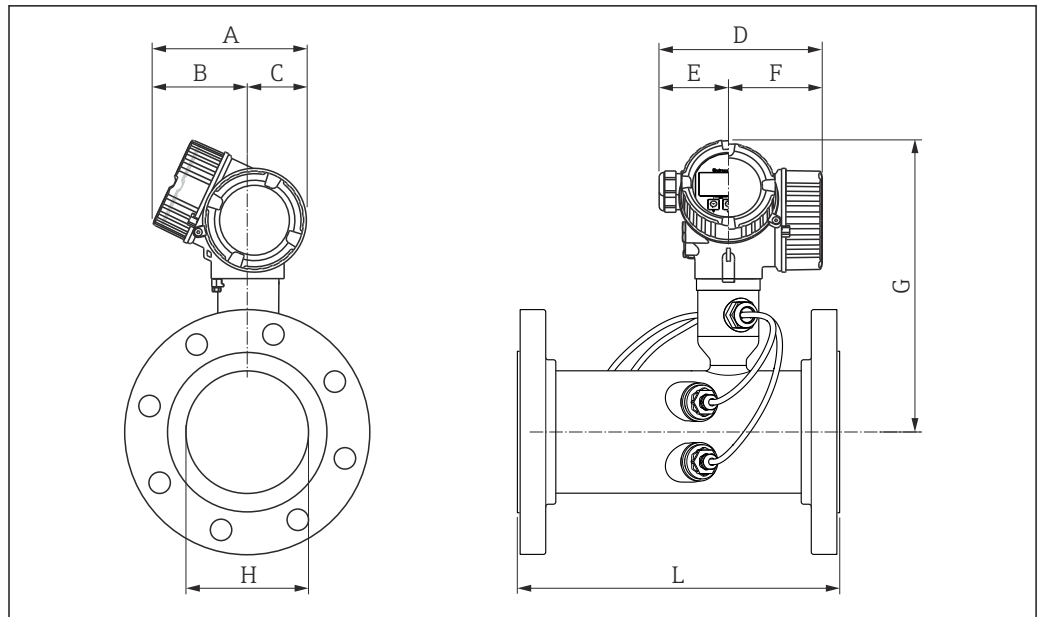

A0015456

DN [in]	A [in]	B ¹⁾ [in]	C [in]	D ²⁾ [in]	E [in]	F ²⁾ [in]	G ³⁾ [in]	Ø H [in]	L [in]
2	6.38	4.02	2.36	6.50	2.95	3.54	10.0	2.22	9.84
3	6.38	4.02	2.36	6.50	2.95	3.54	10.6	3.34	11.81
4	6.38	4.02	2.36	6.50	2.95	3.54	11.1	4.34	11.81
6	6.38	4.02	2.36	6.50	2.95	3.54	12.1	6.47	13.78
8	6.38	4.02	2.36	6.50	2.95	3.54	13.2	8.42	15.75

- 1) For version without local display: values - 0.28 in
- 2) For version with overvoltage protection (OVP): values + 0.31 in
- 3) For version without local display: values - 0.39 in

Without flange

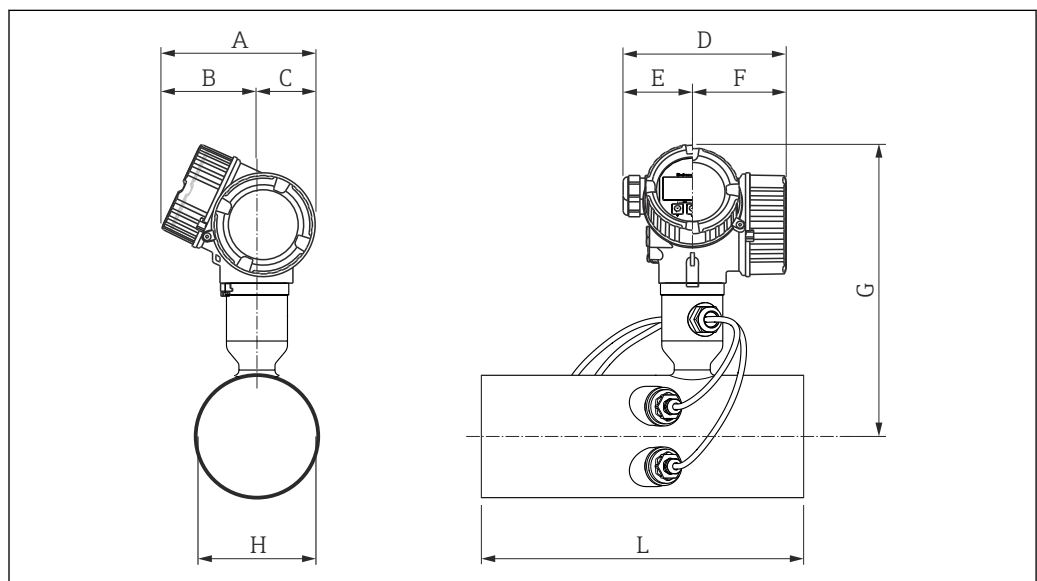

A0016233

Dimensions in US units for version without overvoltage protection

DN [in]	A [in]	B ¹⁾ [in]	C [in]	D ²⁾ [in]	E [in]	F ²⁾ [in]	G ³⁾ [in]	Ø H [in]	L [in]
2	6.38	4.02	2.36	6.5	2.95	3.54	10.0	2.22	11.1
3	6.38	4.02	2.36	6.5	2.95	3.54	10.6	3.34	13.2
4	6.38	4.02	2.36	6.5	2.95	3.54	11.1	4.34	13.3
6	6.38	4.02	2.36	6.5	2.95	3.54	12.1	6.47	15.5
8	6.38	4.02	2.36	6.5	2.95	3.54	13.1	8.42	17.6

- 1) For version without local display: values - 0.28 in
- 2) For version with overvoltage protection (OVP): values + 0.31 in
- 3) Version without local display: values - 0.39 in

Lap joint flange

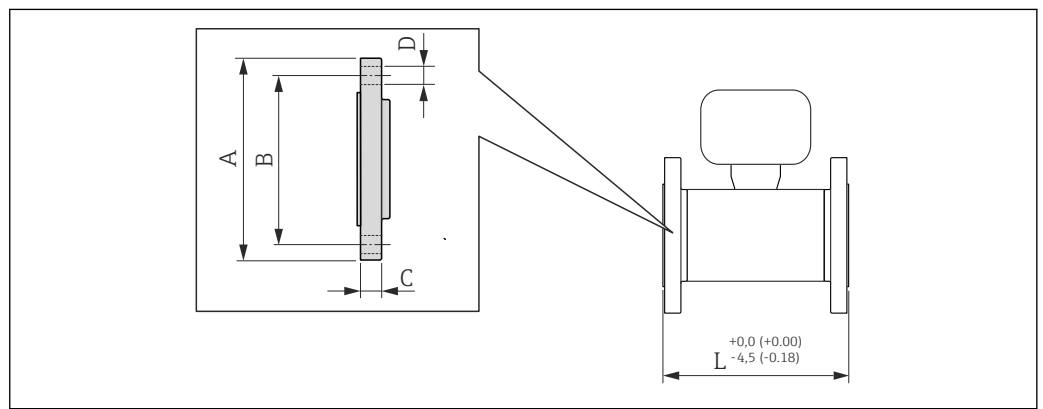

17 mm (in)

Lap joint flange according to ASME B16.5: Class 150
 1.4404 (316L): order code for "Process connection", option A14
 A105: order code for "Process connection", option A12

DN [in]	A [in]	B [in]	C [in]	Ø D [in]	L [in]
2	6.00	4.75	0.83	4 × 0.75	9.84
3	7.50	6.00	1.02	4 × 0.75	11.81
4	9.00	7.50	1.02	8 × 0.75	11.81
6	11.00	9.50	1.08	8 × 0.88	13.78
8	13.50	11.75	1.22	8 × 0.88	15.75

Accessories

Replacement tool

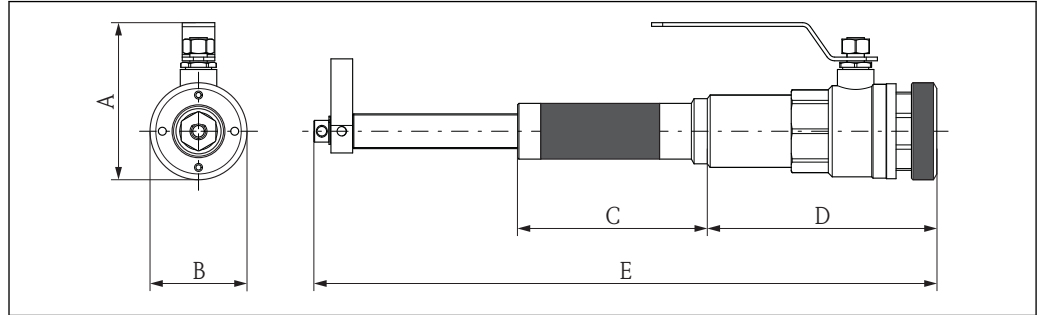

A0016020

Replacement tool				
<i>Order code for "Accessory enclosed", option PS</i>				
A [in]	φ B [in]	C [in]	D [in]	E [in]
4.25	2.64	5.16	6.26	13 to 17

Flow conditioner

(according to EN 1092-1 (DIN 2501))

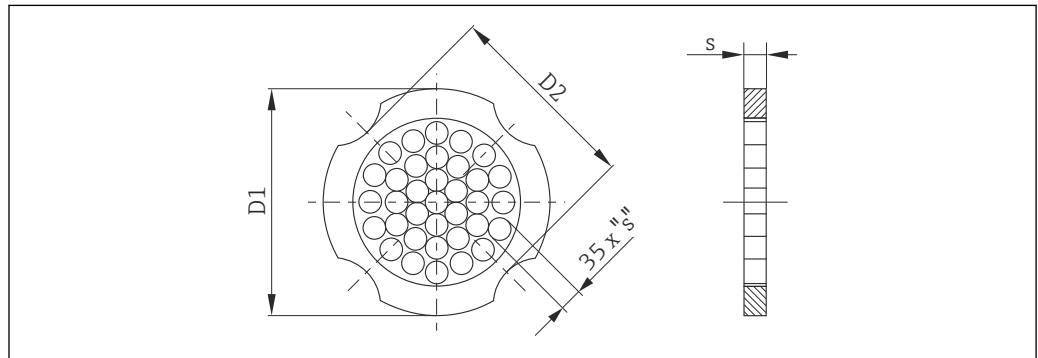

A0001941

Flow conditioner according to ASME B16.5: Class 150				
<i>Order code for "Accessory enclosed", option PF</i>				
DN [in]	Pressure rating	Centering diameter [in]	D1¹⁾ / D2²⁾	s [in]
2	Class 150	4.09	D2	0.27
3	Class 150	5.45	D1	0.40
4	Class 150	6.95	D2	0.52
6	Class 150	8.81	D1	0.79
8	Class 150	10.8	D2	1.04

- 1) The flow conditioner is fitted at the outer diameter between the bolts.
- 2) The flow conditioner is fitted at the indentations between the bolts.

Weight

Weight in SI units

Compact version

All values (weight) refer to devices with EN (DIN) PN 10/16 flanges. Weight information in [kg].

Order code for "Housing", option C "GT20 two-chamber, aluminum coated"

Nominal diameter [mm]	Lap joint flange		Lap joint flange, stamped plate	
	1.4306	S235JR	1.4301	S235JR
50	9.5		5.9	
80	11.8		7.5	
100	14.0		9.1	
150	20.9		12.3	
200	27.9		19.1	

Order code for "Housing", option S, "GT18 two-chamber, stainless steel"

Nominal diameter [mm]	Lap joint flange		Lap joint flange, stamped plate	
	1.4306	S235JR	1.4301	S235JR
50	12.4		8.7	
80	14.7		10.3	
100	16.9		12.0	
150	23.7		15.2	
200	30.7		22.0	

Weight in US units

Compact version

All values (weight) refer to devices with ASME B16.5, Class 150 flanges. Weight information in [lbs].

Order code for "Housing", option C "GT20 two-chamber, aluminum coated"

Nominal diameter [in]	Lap joint flange	
	316L	A105
2	18.8	
3	28.6	
4	38.0	
6	49.8	
8	77.4	

Order code for "Housing", option S "GT18 two-chamber, stainless steel"

Nominal diameter [in]	Lap joint flange	
	316L	A105
2	25.1	
3	34.9	
4	44.3	
6	56.1	
8	83.7	

Accessories*Replacement tool*

Weight [kg]	Weight [lbs]
3.66	8.07

*Flow conditioner**Weight in SI units*

DN [mm]	Pressure rating	Weight [kg]
50	PN 10/16	0.5
	Class 150	0.5
80	PN 10/16	1.4
	Class 150	1.2
100	PN 10/16	2.4
	Class 150	2.7
150	PN 10/16	6.3
	Class 150	6.3
200	PN 10	11.5
	Class 150	12.3

Weight in US units

DN [in]	Pressure rating	Weight [lbs]
2	Class 150	1.1
3	Class 150	2.6
4	Class 150	6.0
6	Class 150	14.0
8	Class 150	27.0

Materials**Transmitter housing**

- Order code for "Housing", option **C** "Compact, aluminum coated":
Aluminum, AlSi10Mg, coated
- Order code for "Housing", option **S**: stainless steel 1.4404 (316L)
- Window material: glass

Cable entries/cable glands

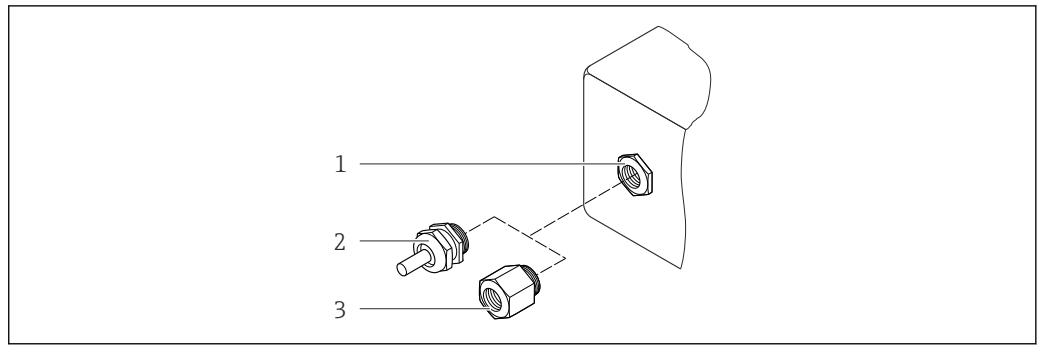

18 Possible cable entries/cable glands

- 1 Cable entry in transmitter housing or connection housing with internal thread M20 x 1.5
- 2 Cable gland M20 x 1.5
- 3 Adapter for cable entry with internal thread G 1/2" or NPT 1/2"

Order code for "Housing", option C "GT20 two-chamber, aluminum coated"

Transmitter		
Cable entry/cable gland	Type of protection	Material
Cable gland M20 x 1.5	<ul style="list-style-type: none"> ■ Non-Ex ■ Ex ia 	Plastic
Adapter for cable entry with internal thread G 1/2"	For non-Ex and Ex (except for CSA Ex d/XP)	Nickel-plated brass
Adapter for cable entry with internal thread NPT 1/2"	For non-Ex and Ex	

Transmitter neck		
Cable gland	Measuring path	Material
Cable gland M20 x 1.5	Two-path	Nickel-plated brass
Cable gland M12 x 1.5	Single-path	

Sensor	
Cable gland	Material
Cable gland M12 x 1.5	Nickel-plated brass

Order code for "Housing", option S, "GT18 two-chamber, stainless steel"

Transmitter		
Cable entry/cable gland	Type of protection	Material
Cable gland M20 x 1.5	<ul style="list-style-type: none"> ■ Non-Ex ■ Ex ia 	Stainless steel ,1.4404
Adapter for cable entry with internal thread G 1/2"	For non-Ex and Ex (except for CSA Ex d/XP)	Stainless steel, 1.4404 (316L)
Adapter for cable entry with internal thread NPT 1/2"	For non-Ex and Ex	

Transmitter neck		
Cable gland	Sensor version	Material
Cable gland M20 × 1.5	Two-path	Stainless steel ,1.4305
Cable gland M12 × 1.5	Single-path	

Sensor		
Cable gland	Sensor version	Material
Cable gland M20 × 1.5	Two-path	Stainless steel ,1.4305
Cable gland M12 × 1.5	Single-path	

Sensor housing

Stainless steel (cold worked):

- 1.4404 (316L)
- 1.4435 (316L)

Process connections

- Stainless steel:
 - 1.4301 (304)
 - 1.4306 (304L)
 - 1.4404 (316L)
- Steel S235JR
- Carbon steel A105



List of all available process connections → 40

Seals

- Converter: HNBR
- Temperature sensor: AFM 34

Accessories

Replacement tool

- Knurled handle: aluminum
- Stop cock: nickel-plated brass
- Shaft: brass
- Tensioning element: tempered steel

Flow conditioner

Stainless steel 1.4404 (316L) (in compliance with NACE MR0175-2003 and MR0103-2003)

Weather protection cover

Stainless steel 1.4404 (316L)

Process connections

Flanges:

- EN 1092-1 (DIN 2501)
- ASME B16.5



For information on the materials of the process connections → 40

Operability

Operating concept

Operator-oriented menu structure for user-specific tasks

- Commissioning
- Operation
- Diagnostics
- Expert level

Quick and safe commissioning

- Guided menus ("Make-it-run" wizards) for applications
- Menu guidance with brief explanations of the individual parameter functions

Reliable operation

- Operation in the following languages:
 - Via local display:
 - English, German, French, Spanish, Italian, Dutch, Portuguese, Polish, Russian, Turkish, Chinese, Japanese, Korean, Bahasa (Indonesian), Vietnamese, Czech, Swedish
 - Via "FieldCare" operating tool:
 - English, German, French, Spanish, Italian, Chinese, Japanese
- Uniform operating philosophy applied to device and operating tools
- If replacing the electronic module, transfer the device configuration via the integrated memory (integrated HistoROM) which contains the process and measuring device data and the event logbook. No need to reconfigure.

Efficient diagnostics increase measurement availability

- Troubleshooting measures can be called up via the device and in the operating tools
- Diverse simulation options, logbook for events that occur and optional line recorder functions

Local operation



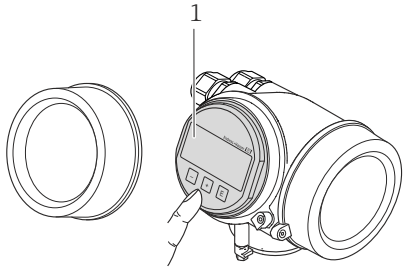
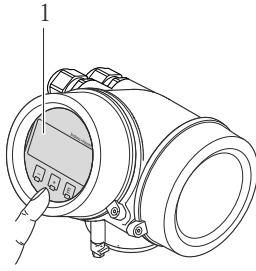



Via display module

Order code for "Display; Operation", option C "SD02"	Order code for "Display; Operation", option E "SD03"
 <p style="text-align: right; font-size: small;">A0015544</p>	 <p style="text-align: right; font-size: small;">A0015546</p>
1 <i>Operation with pushbuttons</i>	1 <i>Operation with touch control</i>

Display elements

- 4-line display
- With order code for "Display; operation", option **E**:
 - White background lighting; switches to red in event of device errors
- Format for displaying measured variables and status variables can be individually configured
- Permitted ambient temperature for the display: -20 to +60 °C (-4 to +140 °F)
 - The readability of the display may be impaired at temperatures outside the temperature range.

Operating elements

- With order code for "Display; operation", option **C**:
 - Local operation with 3 push buttons:   
- With order code for "Display; operation", option **E**:
 - External operation via touch control; 3 optical keys:   
- Operating elements also accessible in various hazardous areas

Additional functionality

- Data backup function
The device configuration can be saved in the display module.
- Data comparison function
The device configuration saved in the display module can be compared to the current device configuration.
- Data transfer function
The transmitter configuration can be transmitted to another device using the display module.

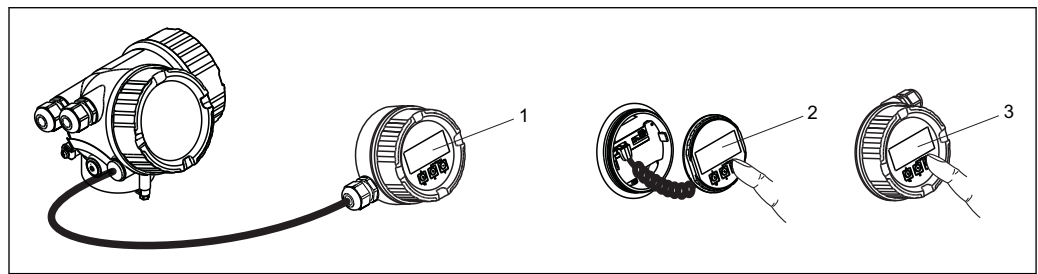
Via remote display and operating module FHX50

A0013137

▣ 19 Operating options via FHX50

- 1 Housing of remote display and operating module FHX50
- 2 SD02 display and operating module, push buttons: cover must be opened for operation
- 3 SD03 display and operating module, optical buttons: operation possible through cover glass

Remote operation**Via HART protocol**

This communication interface is available in device versions with a HART output.

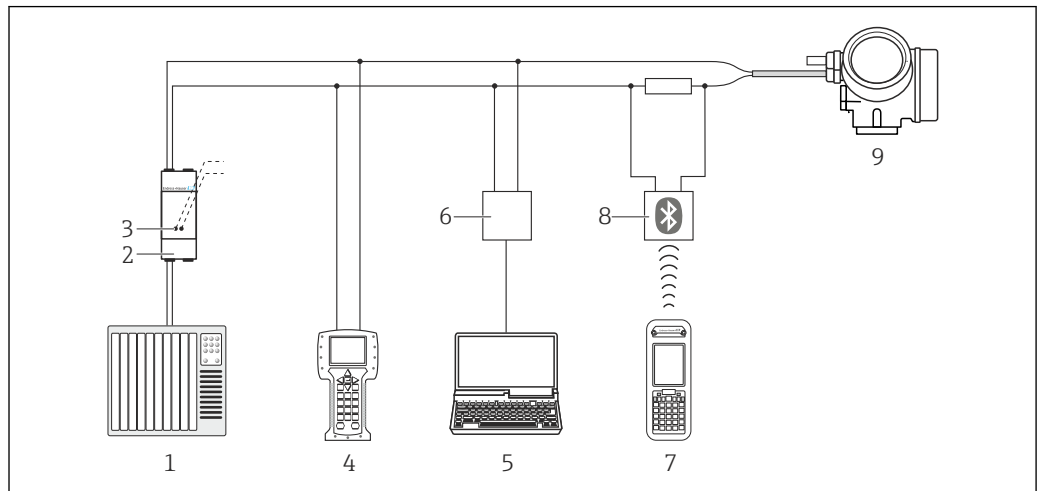

A0013764

▣ 20 Options for remote operation via HART protocol

- 1 Control system (e.g. PLC)
- 2 Transmitter power supply unit, e.g. RN221N (with communication resistor)
- 3 Connection for Commubox FXA195 and Field Communicator 475
- 4 Field Communicator 475
- 5 Computer with operating tool (e.g. FieldCare, AMS Device Manager, SIMATIC PDM)
- 6 Commubox FXA195 (USB)
- 7 Field Xpert SFX350 or SFX370
- 8 VIATOR Bluetooth modem with connecting cable
- 9 Transmitter

Service interface

Via service interface (CDI)

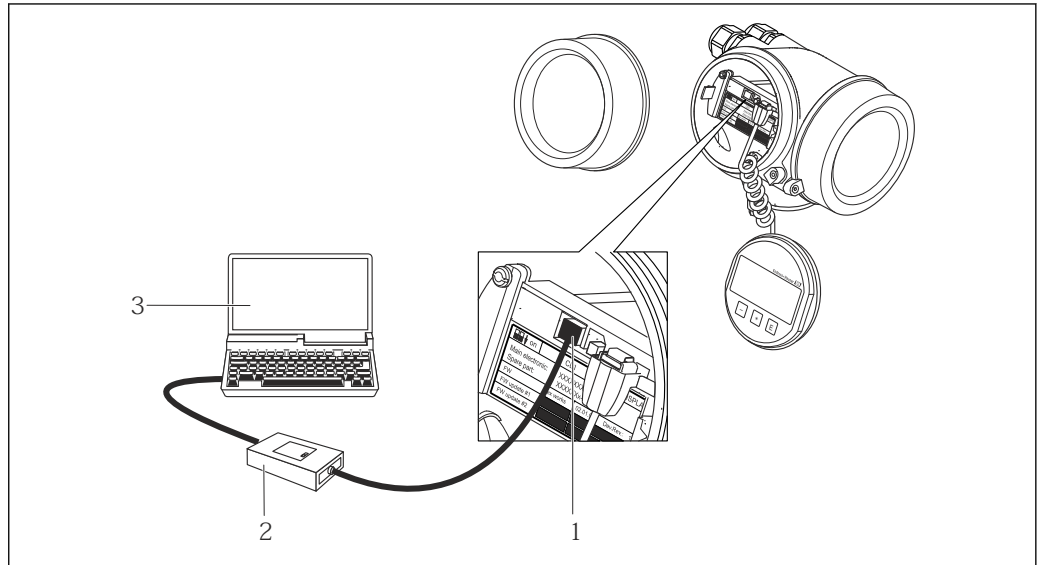

- 1 Service interface (CDI = Endress+Hauser Common Data Interface) of the measuring device
- 2 Commubox FXA291
- 3 Computer with "FieldCare" operating tool with COM DTM "CDI Communication FXA291"

A0014019

Certificates and approvals

CE mark

The measuring system is in conformity with the statutory requirements of the applicable EC Directives. These are listed in the corresponding EC Declaration of Conformity along with the standards applied.

Endress+Hauser confirms successful testing of the device by affixing to it the CE mark.

C-Tick symbol

The measuring system meets the EMC requirements of the "Australian Communications and Media Authority (ACMA)".

Ex approval

The measuring device is certified for use in hazardous areas and the relevant safety instructions are provided in the separate "Safety Instructions" (XA) document. Reference is made to this document on the nameplate.

 The separate Ex documentation (XA) containing all the relevant explosion protection data is available from your Endress+Hauser sales center.

ATEX/IECEX

Currently, the following versions for use in hazardous areas are available:

Ex d

Category	Type of protection
II2G / Zone 1	Ex d ia IIC T6-T1 Gb

Ex ia

Category	Type of protection
II2G / Zone 1	Ex ia IIC T6-T1 Gb

cCSA_{US}

Currently, the following versions for use in hazardous areas are available:

XP

Category	Type of protection
Class I Division 1 Groups ABCD	XP (Ex d Flameproof version)

IS

Category	Type of protection
Class I Division 1 Groups ABCD	IS (Ex i Intrinsically safe version), Entity-Parameter*

NI

Category	Type of protection
Class I Division 2 Groups ABCD	NI (Non-incendive version), NIFW-Parameter*

*= Entity and NIFW parameters according to control drawings

NEPSI

Currently, the following versions for use in hazardous areas are available:

Ex d

Category	Type of protection
Zone 1	Ex d[ia] IIC T6-T1 Gb

Ex ia

Category	Type of protection
Zone 1	Ex ia IIC T6-T1 Gb

HART certification**HART interface**

The measuring device is certified and registered by the HCF (HART Communication Foundation). The measuring system meets all the requirements of the following specifications:

- Certified according to HART 7
- The device can also be operated with certified devices of other manufacturers (interoperability)

Pressure Equipment Directive

The devices can be ordered with or without a PED approval. If a device with a PED approval is required, this must be explicitly stated in the order.

- With the PED/G1/x (x = category) marking on the sensor nameplate, Endress+Hauser confirms compliance with the "Essential Safety Requirements" specified in Annex I of the Pressure Equipment Directive 97/23/EC.
- Devices bearing this marking (PED) are suitable for the following types of medium: Media in Group 1 and 2 with a vapor pressure greater than, or smaller and equal to 0.5 bar (7.3 psi)
- Devices not bearing this marking (PED) are designed and manufactured according to good engineering practice. They meet the requirements of Art.3 Section 3 of the Pressure Equipment Directive 97/23/EC. The range of application is indicated in tables 6 to 9 in Annex II of the Pressure Equipment Directive.

Other standards and guidelines

- EN 60529
Degrees of protection provided by enclosures (IP code)
- EN 61010-1
Safety requirements for electrical equipment for measurement, control and laboratory use
- IEC/EN 61326
Emission in accordance with Class A requirements. Electromagnetic compatibility (EMC requirements).
- NAMUR NE 21
Electromagnetic compatibility (EMC) of industrial process and laboratory control equipment

- NAMUR NE 32
Data retention in the event of a power failure in field and control instruments with microprocessors
- NAMUR NE 43
Standardization of the signal level for the breakdown information of digital transmitters with analog output signal.
- NAMUR NE 53
Software of field devices and signal-processing devices with digital electronics
- NAMUR NE 80
The application of the pressure equipment directive to process control devices
- NAMUR NE 105
Specifications for integrating fieldbus devices in engineering tools for field devices
- NAMUR NE 107
Self-monitoring and diagnosis of field devices
- NAMUR NE 131
Requirements for field devices for standard applications

Ordering information

Detailed ordering information is available from the following sources:

- In the Product Configurator on the Endress+Hauser website: www.endress.com → Select your country → Products → Select measuring technology, software or components → Select the product (picklists: measurement method, product family etc.) → Device support (right-hand column): Configure the selected product → The Product Configurator for the selected product opens.
- From your Endress+Hauser Sales Center: www.addresses.endress.com



Product Configurator - the tool for individual product configuration

- Up-to-the-minute configuration data
- Depending on the device: Direct input of measuring point-specific information such as measuring range or operating language
- Automatic verification of exclusion criteria
- Automatic creation of the order code and its breakdown in PDF or Excel output format
- Ability to order directly in the Endress+Hauser Online Shop

Application packages

Many different application packages are available to enhance the functionality of the device. Such packages might be needed to address safety aspects or specific application requirements.

The application packages can be ordered with the device or subsequently from Endress+Hauser. Detailed information on the order code in question is available from your local Endress+Hauser sales center or on the product page of the Endress+Hauser website: www.endress.com.

Diagnostics functions

Package	Description
HistoROM extended function	<p>Comprises extended functions concerning the event log and the activation of the measured value memory.</p> <p>Event log: Memory volume is extended from 20 message entries (basic version) to up to 100 entries.</p> <p>Data logging (line recorder):</p> <ul style="list-style-type: none"> ■ Memory capacity for up to 1000 measured values is activated. ■ 250 measured values can be output via each of the 4 memory channels. The recording interval can be defined and configured by the user. ■ Data logging is visualized via the local display or FieldCare.

Heartbeat Technology

Package	Description
Heartbeat Verification +Monitoring	<p>Heartbeat Monitoring: Continuously supplies monitoring data, which are characteristic of the measuring principle, for an external condition monitoring system. This makes it possible to:</p> <ul style="list-style-type: none"> ▪ Draw conclusions - using these data and other information - about the impact the measuring application has on the measuring performance over time. ▪ Schedule servicing in time. ▪ Monitor the product quality, e.g. gas pockets. <p>Heartbeat Verification: Makes it possible to check the device functionality on demand when the device is installed, without having to interrupt the process.</p> <ul style="list-style-type: none"> ▪ Access via local operation or other operating interfaces, such as FieldCare for instance. ▪ Documentation of device functionality within the framework of manufacturer specifications, for proof testing for instance. ▪ End-to-end, traceable documentation of the verification results, including report. ▪ Makes it possible to extend calibration intervals in accordance with operator's risk assessment.





Accessories

Various accessories, which can be ordered with the device or subsequently from Endress+Hauser, are available for the device. Detailed information on the order code in question is available from your local Endress+Hauser sales center or on the product page of the Endress+Hauser website: www.endress.com.

Device-specific accessories

For the transmitter



Accessories	Description
Prosonic Flow 200 transmitter	<p>Transmitter for replacement or storage. Use the order code to define the following specifications:</p> <ul style="list-style-type: none"> ▪ Approvals ▪ Output ▪ Display / operation ▪ Housing ▪ Software <p> For details, see Installation Instructions EA00104D</p>





<p>Remote display FHX50</p>	<p>FHX50 housing to accommodate a display module →  42.</p> <ul style="list-style-type: none"> ▪ FHX50 housing suitable for: <ul style="list-style-type: none"> – SD02 display module (push buttons) – SD03 display module (touch control) ▪ Housing material: <ul style="list-style-type: none"> – Plastic PBT – Stainless steel CF-3M (316L, 1.4404) ▪ Length of connecting cable: up to max. 60 m (196 ft) (cable lengths available for order: 5 m (16 ft), 10 m (32 ft), 20 m (65 ft), 30 m (98 ft)) <p>The measuring device can be ordered with the FHX50 housing and a display module. The following options must be selected in the separate order codes:</p> <ul style="list-style-type: none"> ▪ Order code for measuring device, feature 030: Option L or M "Prepared for FHX50 display" ▪ Order code for FHX50 housing, feature 050 (device version): Option A "Prepared for FHX50 display" ▪ Order code for FHX50 housing, depends on the desired display module in feature 020 (display, operation): <ul style="list-style-type: none"> – Option C: for an SD02 display module (push buttons) – Option E: for an SD03 display module (touch control) <p>The FHX50 housing can also be ordered as a retrofit kit. The measuring device display module is used in the FHX50 housing. The following options must be selected in the order code for the FHX50 housing:</p> <ul style="list-style-type: none"> ▪ Feature 050 (measuring device version): option B "Not prepared for FHX50 display" ▪ Feature 020 (display, operation): option A "None, existing displayed used" <p> For details, see Special Documentation SD01007F</p>
<p>Overvoltage protection for 2-wire devices</p>	<p>Ideally, the overvoltage protection module should be ordered directly with the device. See product structure, characteristic 610 "Accessory mounted", option NA "Overvoltage protection". Separate order necessary only if retrofitting.</p> <ul style="list-style-type: none"> ▪ OVP10: For 1-channel devices (characteristic 020, option A): ▪ OVP20: For 2-channel devices (characteristic 020, options B, C, E or G) <p> For details, see Special Documentation SD01090F.</p>
<p>Weather protection cover</p>	<p>Is used to protect the measuring device from the effects of the weather: e.g. rainwater, excess heating from direct sunlight or extreme cold in winter.</p> <p> For details, see Special Documentation SD00333F</p>

For the sensor

Accessories	Description
<p>Replacement tool</p>	<p>Is used to remove the converters on the fly for cleaning or replacement purposes.</p> <p> For details, see Installation Instructions EA00108D</p>
<p>Flow conditioner</p>	<p>Is used to shorten the necessary inlet run.</p>

Communication-specific accessories

Accessories	Description
<p>Commubox FXA195 HART</p>	<p>For intrinsically safe HART communication with FieldCare via the USB interface.</p> <p> For details, see "Technical Information" TI00404F</p>
<p>Commubox FXA291</p>	<p>Connects Endress+Hauser field devices with a CDI interface (= Endress+Hauser Common Data Interface) and the USB port of a computer or laptop.</p> <p> For details, see the "Technical Information" document TI405C/07</p>
<p>HART Loop Converter HMX50</p>	<p>Is used to evaluate and convert dynamic HART process variables to analog current signals or limit values.</p> <p> For details, see "Technical Information" TI00429F and Operating Instructions BA00371F</p>





Wireless HART adapter SWA70	<p>Is used for the wireless connection of field devices. The WirelessHART adapter can be easily integrated into field devices and existing infrastructures, offers data protection and transmission safety and can be operated in parallel with other wireless networks with minimum cabling complexity.</p> <p> For details, see Operating Instructions BA00061S</p>
Fieldgate FXA320	<p>Gateway for the remote monitoring of connected 4-20 mA measuring devices via a Web browser.</p> <p> For details, see "Technical Information" TI00025S and Operating Instructions BA00053S</p>
Fieldgate FXA520	<p>Gateway for the remote diagnostics and remote configuration of connected HART measuring devices via a Web browser.</p> <p> For details, see "Technical Information" TI00025S and Operating Instructions BA00051S</p>
Field Xpert SFX350	<p>Field Xpert SFX350 is a mobile computer for commissioning and maintenance. It enables efficient device configuration and diagnostics for HART and FOUNDATION Fieldbus devices in the non-Ex area.</p> <p> For details, see Operating Instructions BA01202S</p>
Field Xpert SFX370	<p>Field Xpert SFX370 is a mobile computer for commissioning and maintenance. It enables efficient device configuration and diagnostics for HART and FOUNDATION Fieldbus devices in the non-Ex area and the Ex area.</p> <p> For details, see Operating Instructions BA01202S</p>

Service-specific accessories

Accessories	Description
Applicator	<p>Software for selecting and sizing Endress+Hauser measuring devices:</p> <ul style="list-style-type: none"> Calculation of all the necessary data for identifying the optimum flowmeter: e.g. nominal diameter, pressure loss, accuracy or process connections. Graphic illustration of the calculation results <p>Administration, documentation and access to all project-related data and parameters throughout the entire life cycle of a project.</p> <p>Applicator is available:</p> <ul style="list-style-type: none"> Via the Internet: https://wapps.endress.com/applicator On CD-ROM for local PC installation.
W@M	<p>Life cycle management for your plant</p> <p>W@M supports you with a wide range of software applications over the entire process: from planning and procurement, to the installation, commissioning and operation of the measuring devices. All the relevant device information, such as the device status, spare parts and device-specific documentation, is available for every device over the entire life cycle.</p> <p>The application already contains the data of your Endress+Hauser device. Endress+Hauser also takes care of maintaining and updating the data records.</p> <p>W@M is available:</p> <ul style="list-style-type: none"> Via the Internet: www.endress.com/lifecyclemanagement On CD-ROM for local PC installation.
FieldCare	<p>FDT-based plant asset management tool from Endress+Hauser.</p> <p>It can configure all smart field units in your system and helps you manage them. By using the status information, it is also a simple but effective way of checking their status and condition.</p> <p> For details, see Operating Instructions BA00027S and BA00059S</p>

System components

Accessories	Description
Memograph M graphic display recorder	<p>The Memograph M graphic display recorder provides information on all relevant measured variables. Measured values are recorded correctly, limit values are monitored and measuring points analyzed. The data are stored in the 256 MB internal memory and also on a SD card or USB stick.</p> <p> For details, see "Technical Information" TI00133R and Operating Instructions BA00247R</p>

RN221N	Active barrier with power supply for safe separation of 4-20 mA standard signal circuits. Offers bidirectional HART transmission.  For details, see "Technical Information" TI00073R and Operating Instructions BA00202R
RNS221	Supply unit for powering two 2-wire measuring devices solely in the non-Ex area. Bidirectional communication is possible via the HART communication jacks.  For details, see "Technical Information" TI00081R and Brief Operating Instructions KA00110R
Cerabar M	The pressure transmitter for measuring the absolute and gauge pressure of gases, steam and liquids. It can be used to read in the operating pressure value.  For details, see "Technical Information" TI00426P, TI00436P and Operating Instructions BA00200P, BA00382P
Cerabar S	The pressure transmitter for measuring the absolute and gauge pressure of gases, steam and liquids. It can be used to read in the operating pressure value.  For details, see "Technical Information" TI00383P and Operating Instructions BA00271P

Documentation

-  For an overview of the scope of the associated Technical Documentation, refer to the following:
- The *W@M Device Viewer* : Enter the serial number from the nameplate (www.endress.com/deviceviewer)
 - The *Endress+Hauser Operations App*: Enter the serial number from the nameplate or scan the 2-D matrix code (QR code) on the nameplate.

Standard documentation

Brief Operating Instructions

Measuring device	Documentation code
Prosonic Flow B 200	KA01096D

Operating Instructions

Measuring device	Documentation code
	HART
Prosonic Flow B 200	BA01031D

Description of Device Parameters

Measuring device	Documentation code
	HART
Prosonic Flow B 200	GP01012D

Supplementary device-dependent documentation

Safety Instructions

Contents	Documentation code
ATEX/IECEX Ex d	XA01008D
ATEX/IECEX Ex i	XA01009D
cCSA _{US} XP	XA01010D
cCSA _{US} IS	XA01011D
INMETRO Ex d	XA01307D
INMETRO Ex i	XA01308D

Contents	Documentation code
NEPSI Ex d	XA01068D
NEPSI Ex i	XA01069D

Special Documentation

Contents	Documentation code
Information on the Pressure Equipment Directive	SD00152D
Heartbeat Technology	SD01470D

Installation Instructions

Contents	Documentation code
Installation Instructions for spare part sets	Specified for each individual accessory

Registered trademarks

HART®

Registered trademark of the HART Communication Foundation, Austin, USA

Applicator®, FieldCare®, Field Xpert™, HistoROM®, Heartbeat Technology™

Registered or registration-pending trademarks of the Endress+Hauser Group

www.addresses.endress.com
