

# Level Limit Switch *nivotester FTL 325 P*

**With intrinsically safe signal circuit for connection to the Liquiphant and Soliphant measuring sensor**



## Applications

- Level limit detection in liquid tanks and bulk material silos, also in hazardous explosion areas
- For Zone 0 or Zone 20 measuring sensors
- Liquid detection in pipes for dry running protection for pumps
- Overspill protection for tanks with combustible or non-combustible liquids harmful to water
- Two-point control and level limit detection with one switching instrument
- Application in safety related systems with requirements for functional safety up to SIL3 in accordance to IEC 61508 when using Liquiphant M/S with electronic insert FEL 57

## Benefits at a glance

- Intrinsically safe signal circuits [Ex ia] for problem-free use of measuring sensor in explosion hazardous areas
- Highest functional SIL safety (see also Safety Manual SD 111) through:
  - fault-free PFM technology
  - line monitoring through to sensor
  - corrosion monitoring on tuning fork of Liquiphant M measuring sensor
- Compact housing for simple series installation on standard rails in switch cabinet
- Simple wiring using pluggable terminal blocks
- Simple iterative test acc. to WHG by connecting a Liquiphant M and S (high temperature): one-touch operation
- High test depth: from isolating amplifier through to measuring sensor

**Endress + Hauser**

The Power of Know How



# Functions and system design

## Measuring principle

### Signal transmission

The intrinsically safe signal input of the Nivotester FTL 325 P limit switch is galvanically isolated from the mains and the output.

The Nivotester powers the Liquiphant or Soliphant measuring sensors with a two-wire DC loop and receives a frequency which signals whether or not the limit has been reached.

The power supply is superimposed with current pulses (PFM signals) from the measuring transmitter. They have a pulse width of approx. 200  $\mu$ s and a current strength of approx. 10 mA.

### Signal evaluation

The Nivotester evaluates the frequency and switches the output relay for the level alarm. The relay switching state is displayed by a yellow LED on the front panel of the Nivotester.

### Fail-safe circuit

By correctly selecting the fail-safe circuit, you can ensure that the relay always works with quiescent current safety.

- Maximum safety: the relay drops out when the switching point is exceeded (measuring sensor covered), a fault occurs or the power supply fails.
- Minimum safety: the relay drops out when the switching point is undershot (measuring sensor uncovered), a fault occurs or the power supply fails.

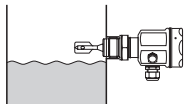
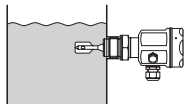
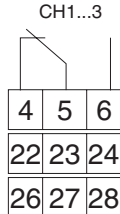
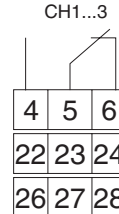
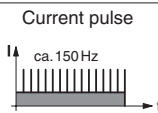
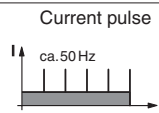
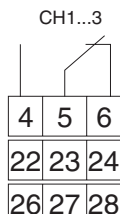
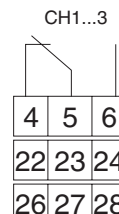
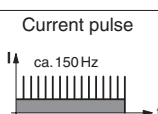
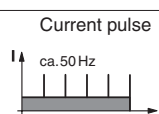
| Level                  |  Tuning fork free   |  Tuning fork covered  |
|------------------------|---|---|
| Maximum safety circuit |  <p>CH1...3</p> <p>4 5 6</p> <p>22 23 24</p> <p>26 27 28</p> |  <p>CH1...3</p> <p>4 5 6</p> <p>22 23 24</p> <p>26 27 28</p> |
|                        |  <p>Current pulse</p> <p>ca. 150 Hz</p>                      |  <p>Current pulse</p> <p>ca. 50 Hz</p>                       |
| Minimum safety circuit |  <p>CH1...3</p> <p>4 5 6</p> <p>22 23 24</p> <p>26 27 28</p> |  <p>CH1...3</p> <p>4 5 6</p> <p>22 23 24</p> <p>26 27 28</p> |
|                        |  <p>Current pulse</p> <p>ca. 150 Hz</p>                      |  <p>Current pulse</p> <p>ca. 50 Hz</p>                       |

L00-FTL325Px-15-06-xx-en-001

Function of the level limit signal and the current pulse dependent on level and fail-safe circuit.

For application with requirements for functional safety in accordance to IEC 61508 (SIL), please note Safety Manual SD 111F.

## Function monitoring

To increase operating safety, the Nivotester is equipped with a function monitoring system. A fault is indicated by a red LED and causes the level alarm relay in the affected channel as well as the fault alarm to drop out. A fault is signalled when the Nivotester receives no more current pulses. This could occur for example in the event of a short-circuit, an interruption in the signalling line to the measuring sensor, vibrator corrosion in the Liquiphant, a defect in the measuring sensor electronics or a defect in the input circuit of the Nivotester. The function of each channel can be monitored by pressing the test button. The power supply to the sensor is then interrupted.

## Simplified iterative test for Liquiphant M and Liquiphant S (HT)

Regular function checks are a statutory requirement for overspill protection systems. For the Nivotester and the downstream plant sections, there is the possibility of a function test without starting up or removing the sensor. For this reason, the Nivotester has a test button on the front panel for each single input. Pressing the test button interrupts the power supply. When the test button is released, the power supply is returned to the Liquiphant and the FEL 57 and the test phase begins. You can find detailed information on this in KA 147F.

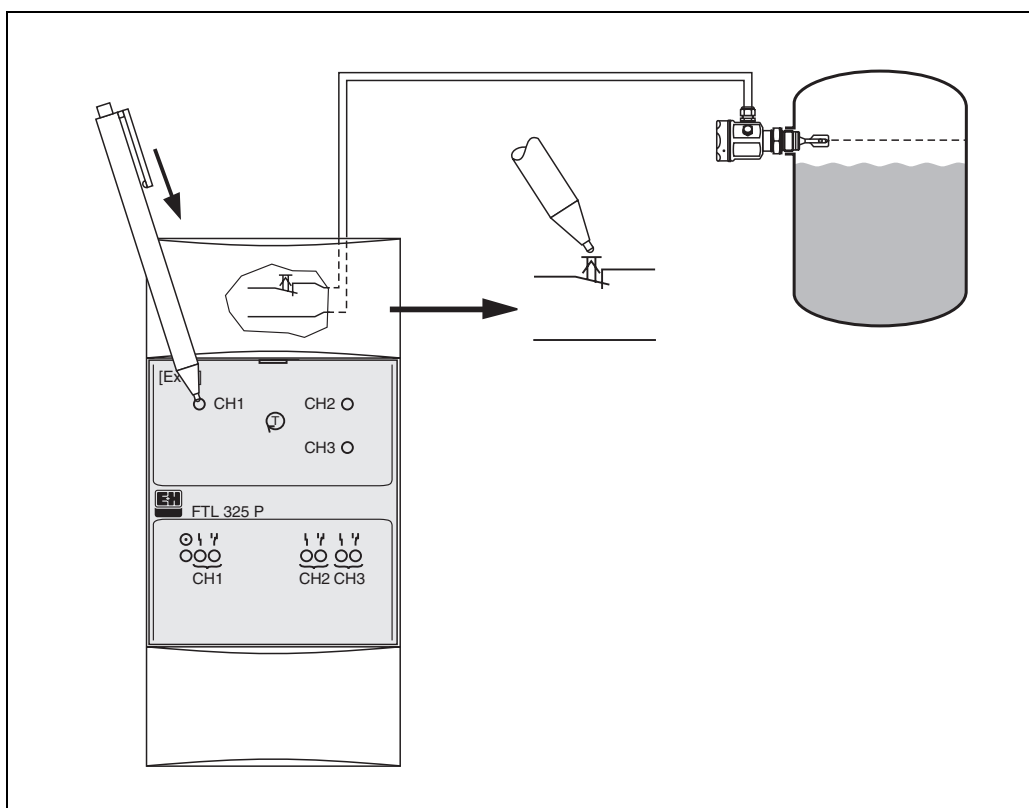

L00-FTL325Px-19-06-xx-xx-001

## Two-point control ( $\Delta s$ )

Two-point control is possible in one tank using the three-channel Nivotester (e.g. for pump control). The switching hysteresis is specified by the installation location of the two measuring sensors.

## Measuring system

A simple measuring device consists of one to three measuring sensors, a 1- or 3-channel Nivotester and control or signal devices. A Liquiphant M, Liquiphant S (high temperature) or Soliphant can be used as measuring sensor.

### 1-channel Nivotester FTL 325 P-#1#1

The measuring device of the 1-channel instrument consists of:

- 1 measuring sensor
- 1-channel Nivotester
- control or signal devices



L00-FTL325Px-14-06-xx-xx-001

### 3-channel Nivotester FTL 325 P-#3#3

There are five possible variants of the measuring device in the three-channel instrument.

1. When all three individual channels are used for measuring the level limit, the measuring device consists of:
  - 3 measuring sensors
  - 3-channel Nivotester
  - control or signal devices

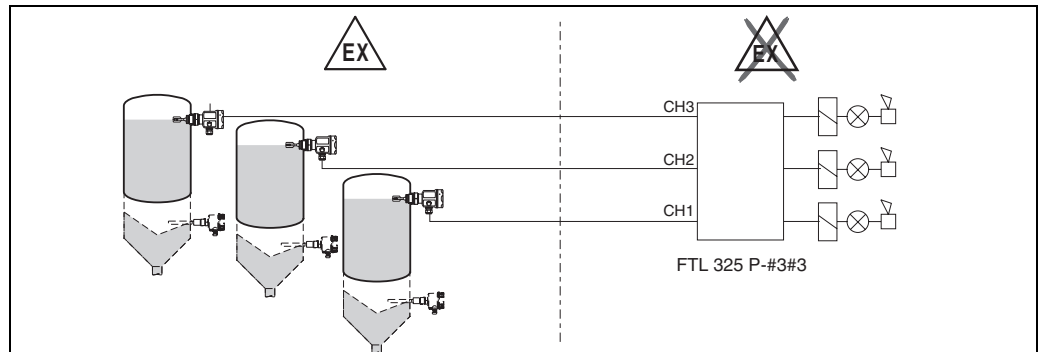

L00-FTL325Px-14-06-xx-xx-002

2. When channels CH2 and CH3 are used for two-point control  $\Delta s$ , the measuring device consists of:
  - 2 measuring sensors
  - 3-channel Nivotester
  - control or signal devices

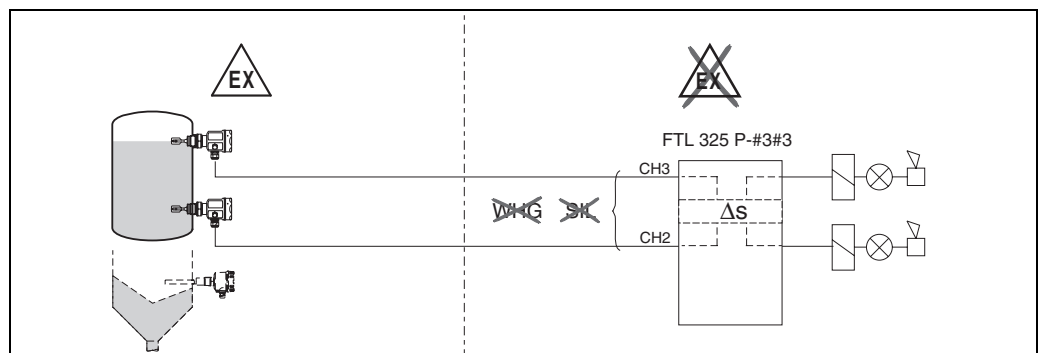

L00-FTL325Px-14-06-xx-xx-003

3. When channels CH2 and Ch3 are used for two-point control  $\Delta s$  and channel CH1 for overspill protection, the measuring device consists of:
  - 3 measuring sensors
  - 3-channel Nivotester
  - control or signal devices

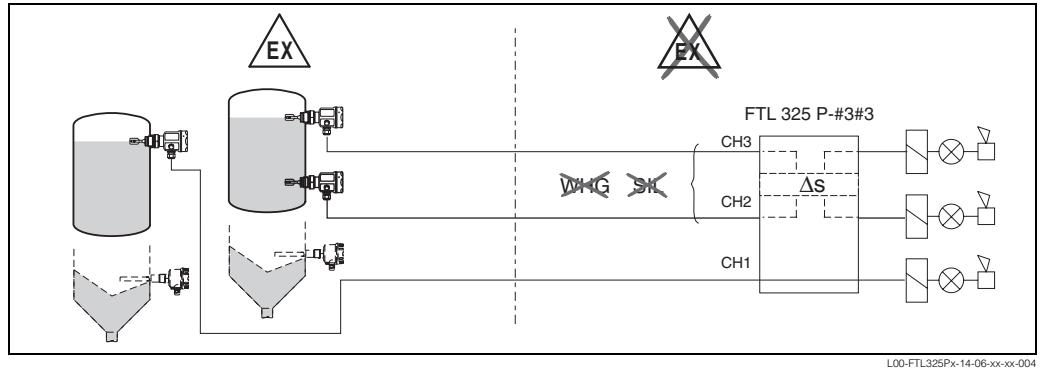

4. When channel CH2 is used for measuring the level limit with two level limit relays and channel CH1 is used for measuring other level limits, the measuring device consists of:
  - 2 measuring sensors
  - 3-channel Nivotester
  - control or signal devices

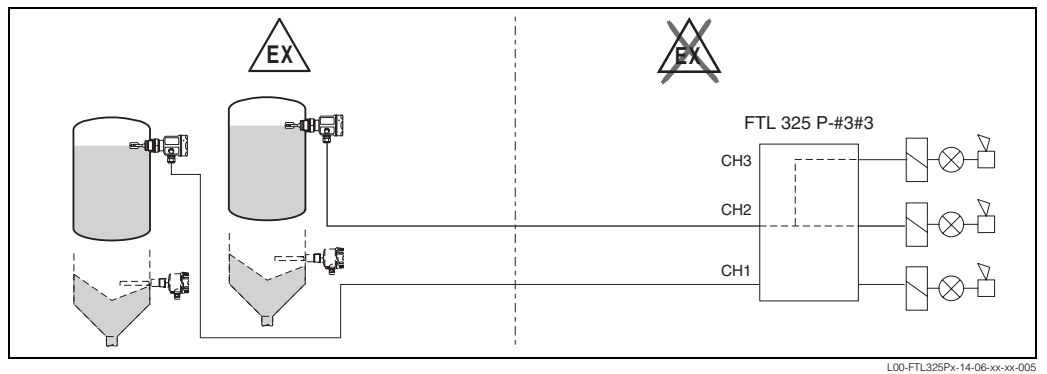

5. When channel CH2 is used for measuring the level limit with two level limit relays, the measuring device consists of:
  - 1 measuring sensor
  - 3-channel Nivotester
  - control or signal devices

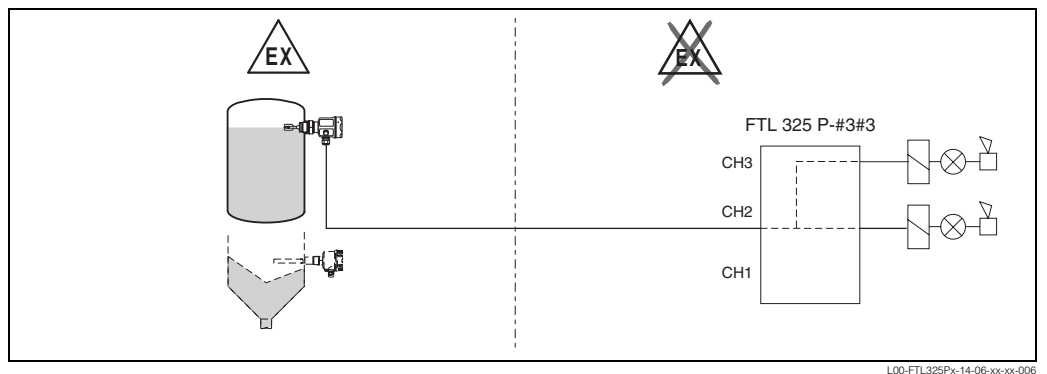

Note!  
As CH1 is not used, the alarm must be switched to "off"!

---

## Input parameters

---

|                          |   |
|--------------------------|---|
| <b>Measured variable</b> | The limit signal can be triggered at minimum or maximum height as required  |
| <b>Measuring range</b>   | The measuring range is dependent on the installation location of the sensors  |
| <b>Input signal</b>      | <ul style="list-style-type: none"><li>• Input FTL 325 P: galvanically isolated from power supply and output</li><li>• Protection type: intrinsically safe [EEx ia] IIC</li><li>• Connectable measuring sensors:<ul style="list-style-type: none"><li>– Liquiphant DL 17 Z, with electronic insert EL 17 Z</li><li>– Liquiphant II FDL 30, FDL 31, FDL 35, FDL 36, with electronic insert FEL 37</li><li>– Liquiphant M FTL 50/51, FTL 50H/51 H, FTL 51 C, with electronic insert FEL 57</li><li>– Liquiphant S (HT) FTL 70/71, with electronic insert FEL 57</li><li>– Soliphant DM 90 Z, DM 91 Z, DM 92 Z, with electronic insert EM 17 Z</li><li>– Soliphant II FTM 30 S, FTM 31 S, FTM 32 S, with electronic insert FEM 37</li></ul></li><li>• Measuring sensor power supply: from Nivotester FTL 325 P</li><li>• Connecting line: two-wire, screening unnecessary</li><li>• Line resistance: max. 25 <math>\Omega</math> per wire</li><li>• Signal transmission: pulse frequency modulation (PFM)</li></ul> |

---

## Output parameters

---

|                      |   |
|----------------------|---|
| <b>Output signal</b> | <ul style="list-style-type: none"><li>• Relay output per channel: one potential-free switch contact for the level alarm</li><li>• Quiescent current safety circuit: minimum/maximum safety selectable with DIL switch</li><li>• Common fault signal relay: potential-free switch contact for fault signalling, of which only two contacts are routed out</li><li>• Switch delay: approx. 0.5 s</li><li>• Switching power of the relay contacts:<br/><br/>U ~ max. 253 V<br/>I ~ max. 2 A<br/>P ~ max. 500 VA at <math>\cos \varphi \geq 0,7</math><br/><br/>U = max. 40 V<br/>I = max. 2 A<br/>P = max. 80 W</li><li>• Life: at least <math>10^5</math> switching operations at maximum contact load</li><li>• Function displays: LEDs for operation, level alarm and fault</li></ul> |
|----------------------|---|

---

|  |    |
|--|----|
| <b>Overvoltage category acc. to EN 61010</b> | II |
|--|----|

---

|                         |                                     |
|-------------------------|-------------------------------------|
| <b>Protection class</b> | II (double or increased insulation) |
|-------------------------|-------------------------------------|

---

|                       |   |
|-----------------------|---|
| <b>Failure signal</b> | Level limit value relay dropped out; fault signal by red LEDs, fault signal relay dropped out |
|-----------------------|---|

---

|                           |  |
|---------------------------|--|
| <b>Galvanic isolation</b> | All input and output channels and relay contacts are galvanically isolated from each other |
|---------------------------|--|

---

---

# Power supply

---

## Electrical connection

### Terminal blocks

The removable terminal blocks are separated into intrinsically safe connections (at top of the instrument) and non-intrinsically safe connections (at bottom of the instrument). Also, the terminal blocks have different colours to make them more easily recognisable. Blue for the intrinsically safe section and grey for the non-intrinsically safe section. This difference helps to ensure safe wiring.

### Connecting the measuring sensor

(at upper, blue terminal blocks)

The two-wire connecting line between the Nivotester FTL 325 P and the Liquiphant or Soliphant measuring sensor can be either a commercially available installation cable or wires in a multi-wire cable for measuring purposes. Line resistance may be a maximum of 25  $\Omega$  per wire.

If strong electromagnetic interference is expected, e.g. from machines or radio devices, a screened cable must be used. Only connect the screen to the ground connection, and not to the Nivotester.

### Installing the measuring sensor in explosion hazardous areas

Please observe all local regulations on explosion protection concerning the type and installation of intrinsically safe signal cabling.

Please refer to the Safety Instructions XA 133F for maximum permissible values of capacitance and inductance.

### Connecting signalling and control devices

(at lower, grey terminal blocks)

The relay function is dependent on the level and the fail-safe circuit.

If an instrument is connected at high inductance (e.g. contactor, solenoid valve etc.), a spark suppressor must be installed to protect the relay contact.

### Connecting the supply voltage

(at lower, grey terminal blocks)

For voltage variants, see the Ordering Information on page 13.

A fuse is built into the power supply circuit. This obviates the need to connect a fine-wire fuse in series. The Nivotester is equipped with reverse polarity protection.

---

## Supply voltage

### AC version:

- Voltage range: 85...253 V AC, 50/60 Hz

### DC version:

- Voltage range: 20...30 V AC / 20...60 V DC
- DC supply: max. 75 mA (1-channel)
- DC supply: max. 165 mA (3-channel)
- Permissible residual ripple within tolerance:  $U_{ss} = \text{max. } 2 \text{ V}$

---

## Power consumption

### AC

1-channel: max. 1.7 W

3-channel: max. 4.2 W

### DC

1-channel: max. 1.5 W (bei  $U_{\min}$  20 V)

3-channel: max. 3.3 W (bei  $U_{\min}$  20 V)

# Accuracy

## Settling time/length

Final switching status after switching on the power supply: approx. 10...40 s, depending on the connected measuring sensor.  
 With Liquiphant M and Liquiphant S (high temperature) note the self-test function of the FEL 57 electronic insert.

# Operating conditions (Installation conditions)

## Installation instructions

### Operating location

The Nivotester must be housed in a switch cabinet outside the explosion hazardous area.  
 A protective housing (IP65) for up to four 1-channel or two 3-channel Nivotesters is available for outdoor installation.

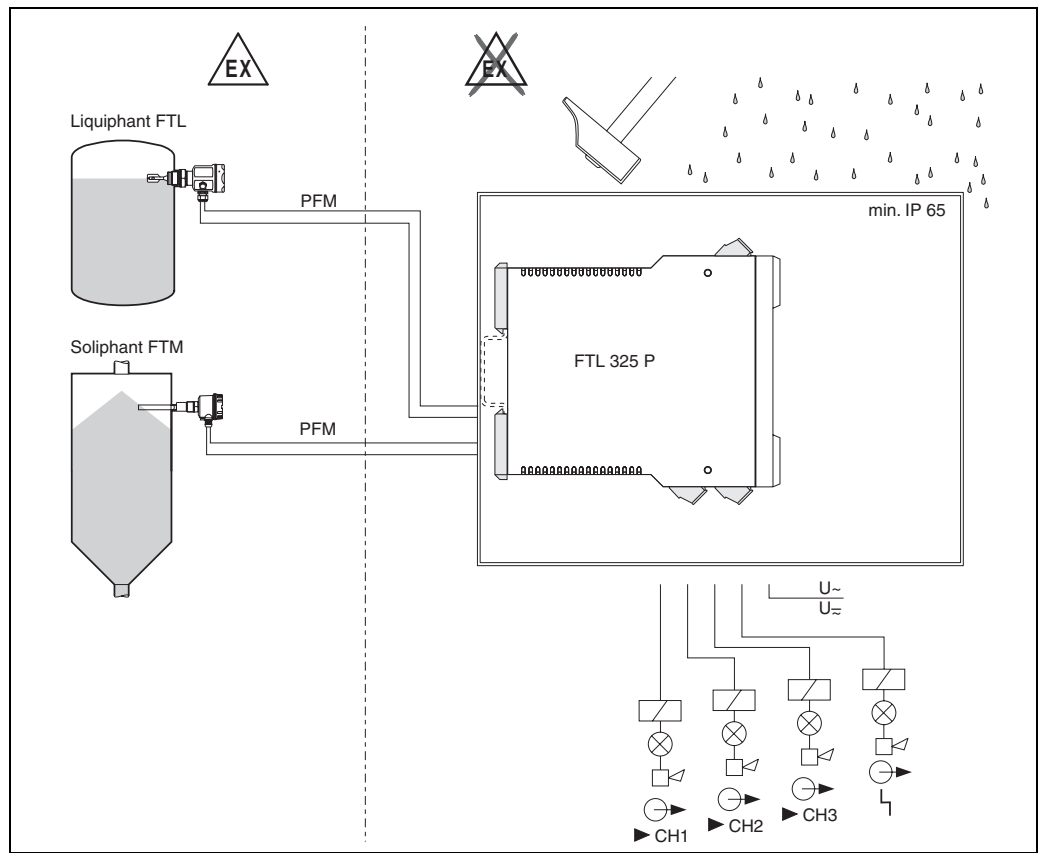

L00-FTL325Px-11-06-xx-xx-001

### Installation position

Vertical on DIN top-hat rail (TS 35 to EN 50022).

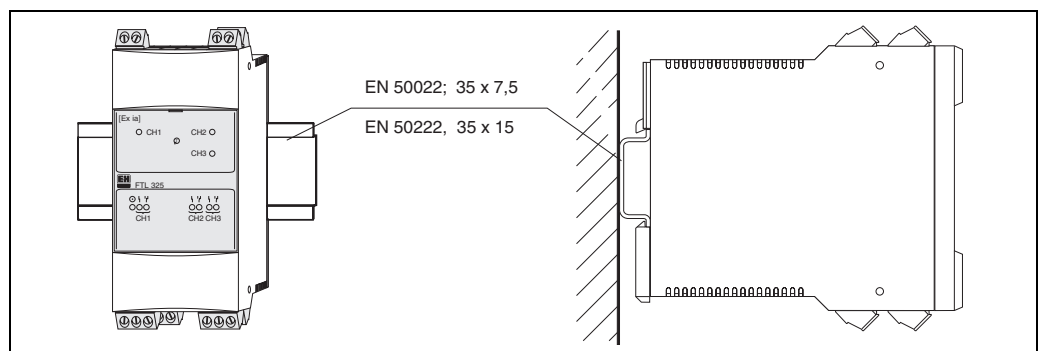

L00-FTL325Px-11-06-xx-xx-001



---

## Operating conditions (Ambient conditions)

---

**Operating location** Switch cabinet or protective housing

---

**Permissible ambient temperatures**

**For single installation**

- -20 °C...+60 °C (-4 °F...+140 °F)

**For rail mounting without gaps**

- -20 °C...+50 °C (-4 °F...+122 °F)

**Storage temperature**

- -20 °C...+85 °C (preferably at +20 °C)  
(-4 °F...+140 °F (preferably at +68 °F))

**Installation in protective housing**

- -20 °C...+40 °C
- Up to four 1-channel or two 3-channel Nivotesters fit in one protective housing.  
By combining these types of instrument, please note that only two 1-channel and one 3-channel are applicable.



**Caution!**

Select a mounting location which protects the instruments from weather and impacts.  
Do not install them in direct sunlight. This is particularly important in regions with a warm climate.

---

**Climatic application class** 3K3  
According to EN 60721-3-3  
3M2  
According to EN 60721-3-3

---

**Ingress protection** IP20

---

**Electromagnetic compatibility (EMC)** Interference emission to EN 61326; Electrical Equipment Class B  
Interference immunity to EN 61326; Annex A (Industrial) and  
NAMUR Recommendation NE 21 (EMC)

---

# Mechanical construction

## Construction, dimensions

- Housing: plastic rail-mounting housing (Minipac construction)
- Installation: on top-hat rail to EN 50022 - 35 x 7.5 or EN 50022 - 35 x 15
- Ingress protection to EN 60529; IP20



Note!  
100 mm = 3.94 in

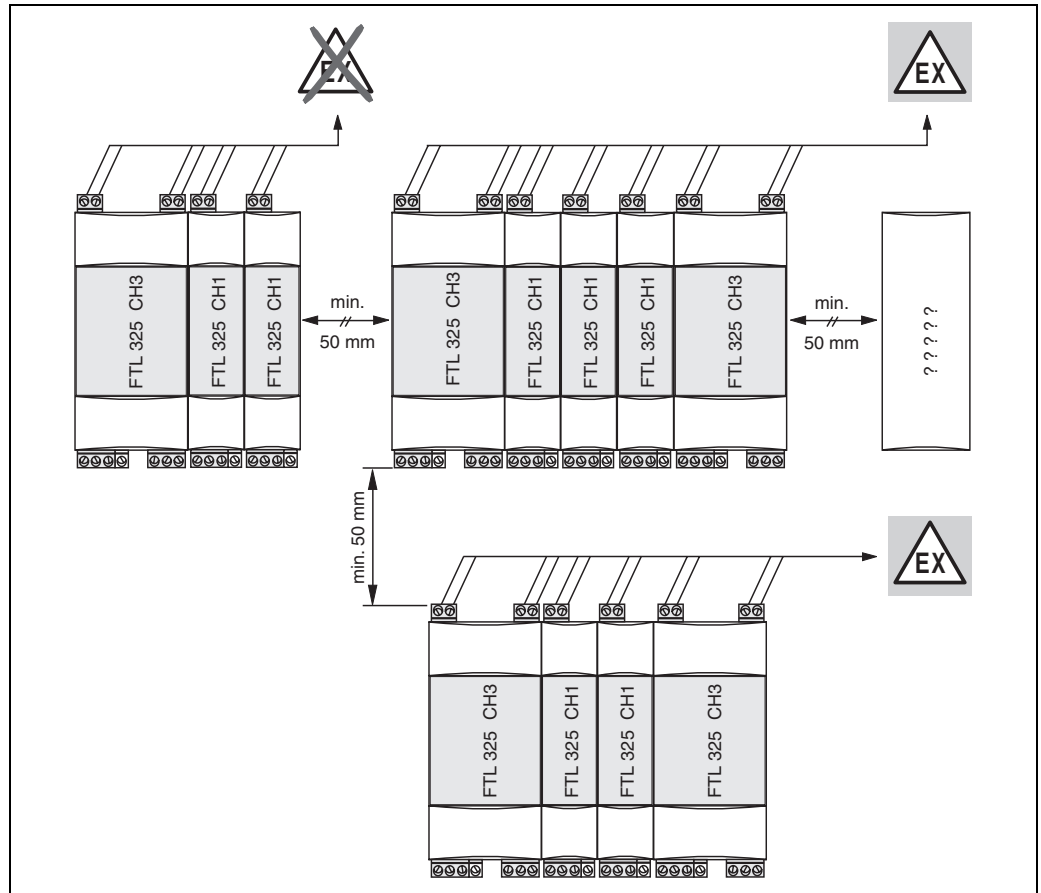

L00-FTL325xx-06-06-xx-xx-001

## Dimensions

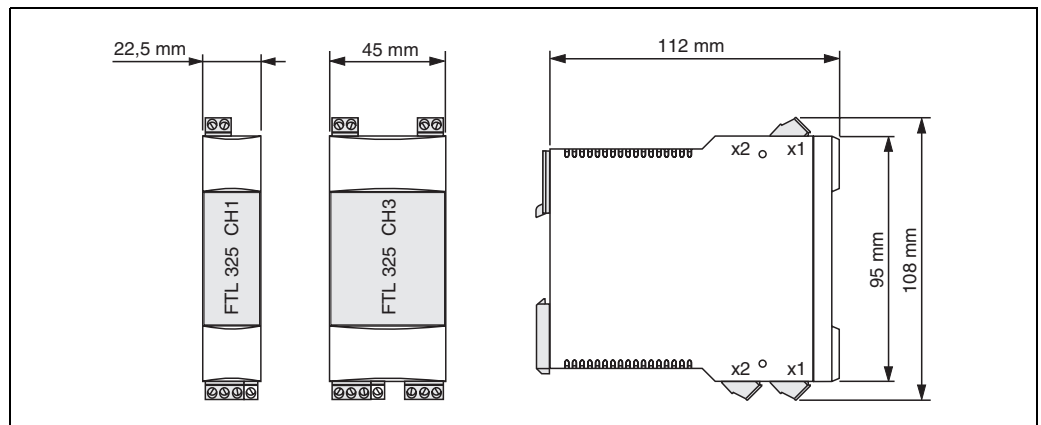

L00-FTL325xx-06-06-xx-xx-002

## Weight

- 1-channel: approx. 148 g
- 3-channel: approx. 250 g

## Materials

### Housing

- Polycarbonat
- Colour: light grey, RAL 7035

### Front cover

- Polyamid PA6
- Colour: blue

### Fixing slide (for fixing to top-hat rail)

- Polyamid PA6
- Colour: black, RAL 9005

## Connection terminals

### 1-channel

- 2 screw terminals: sensor power supply
- 3 screw terminals: limit value relay
- 2 screw terminals: fault signal relay
- 2 screw terminals: power supply

### 3-channel

- 3x2 screw terminals: channel 1 to 3 sensor power supply
- 3x3 screw terminals: limit value relay LV-Rel 1 to 3
- 2 screw terminals: fault signal relay
- 2 screw terminals: power supply

### Connection cross section

max. 1 x 2,5 mm<sup>2</sup> or 2 x 1,5 mm<sup>2</sup>

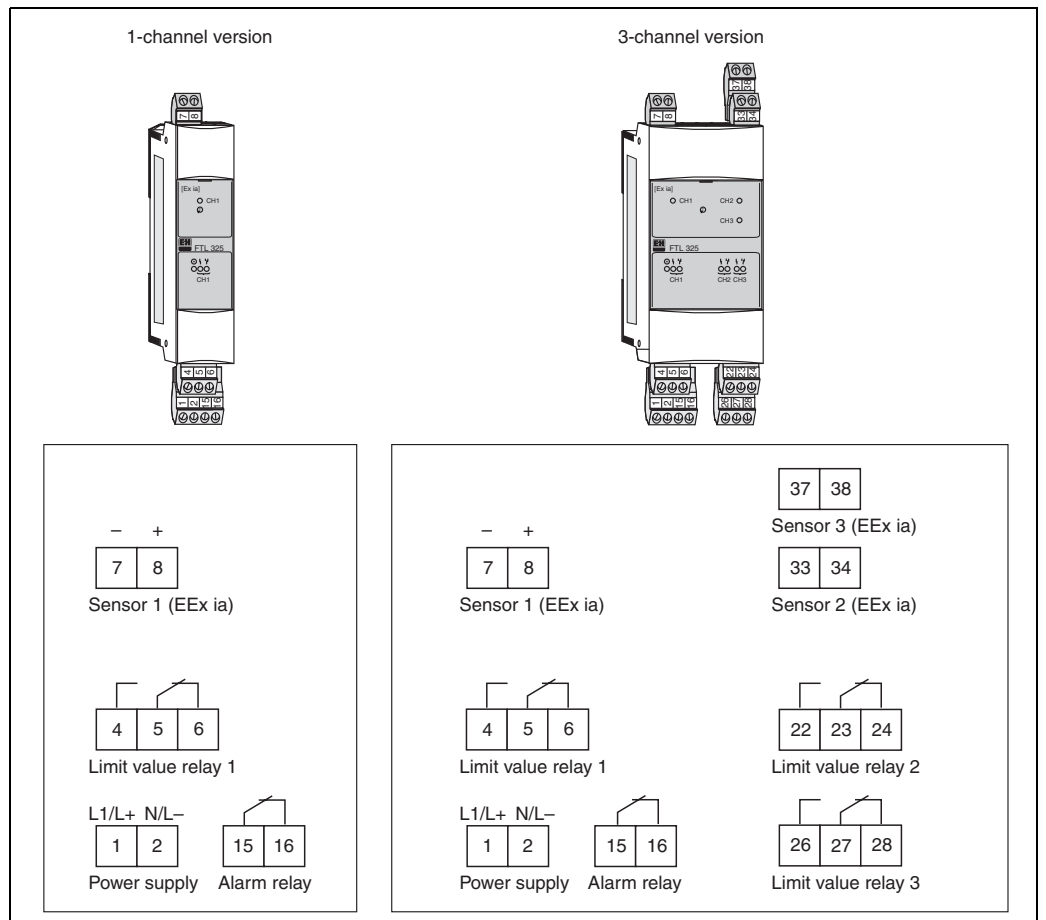

L00-FTL325xx-04-06-xx-de-001

# Display and user interface

## Operating concept

On-site setting with switches behind the hinged front panel

## Display elements

- Green LED: standby
- One red LED per channel: fault signalling
- One yellow LED per channel: picked-up relay (level alarm)

## Operating elements

### 1-channel instrument

- Switch for min/max setting
- Switch for with/without fault signalling on CH1

### 3-channel instrument

- Switch for min/max setting on CH2
- Switch for min/max setting on CH3
- Switch for "Single channel" function (up to three channels)
- Switch for function "Δs"
- Switch for one channel with "two parallel switched limit value relays"

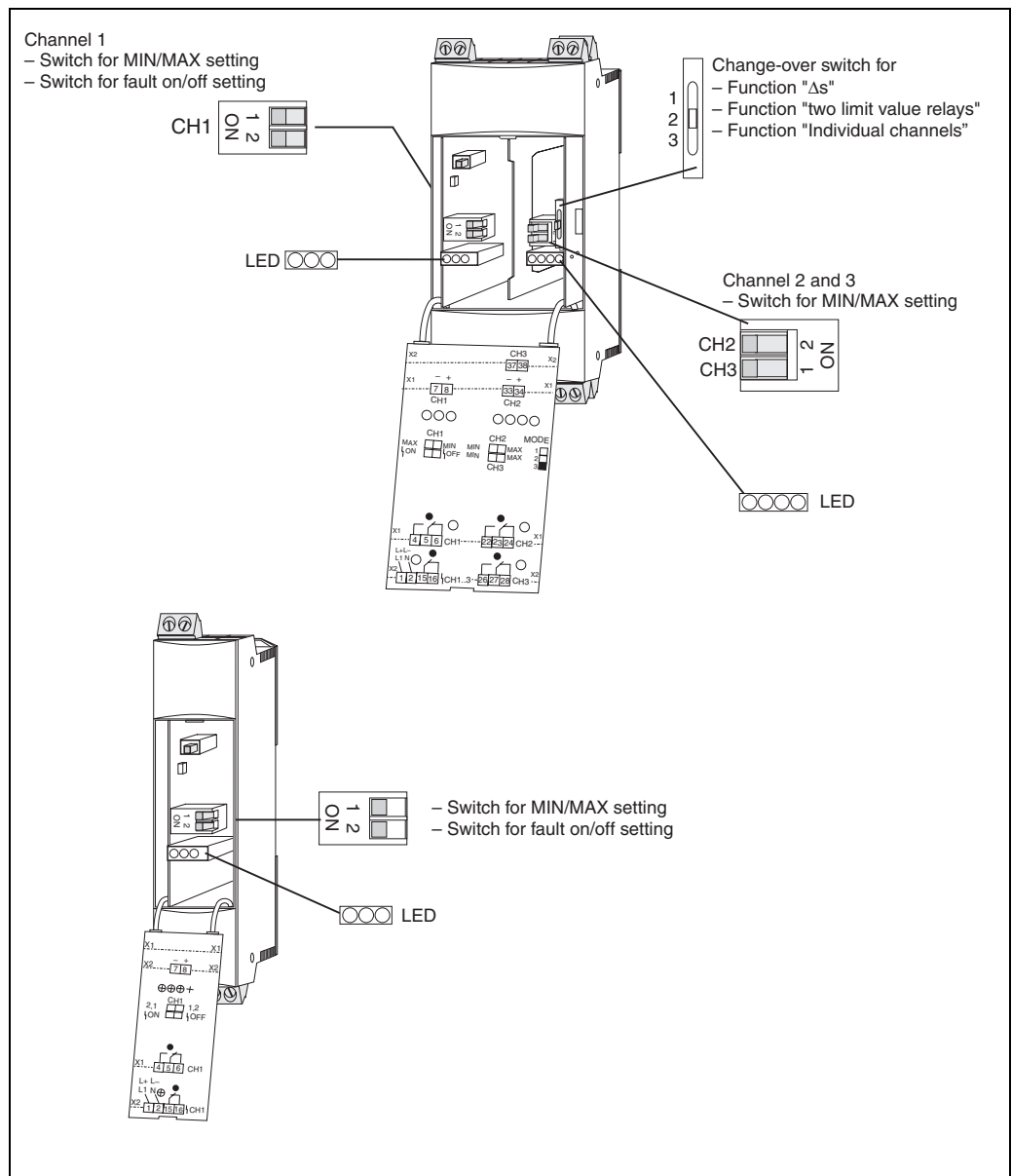

L00-FTL325Px-19-06-xx-de-001

## Certificates and approvals

|  |   |
|--|---|
| <b>CE mark</b>                           | The device meets the statutory requirements of EC directives.<br>Endress+Hauser confirms the successful testing of the device by affixing the CE mark.  |
| <b>Ex approval</b>                       | The Endress+Hauser sales office will provide you with information on the currently suppliable Ex versions (ATEX EEx ia; FM IS; CSA IS)<br>All data relevant for explosion protection can be found in separate Ex documentation (see: Supplementary Documentation). This can be requested as necessary.  |
| <b>Protection type</b>                   | [EEx ia] IIC  |
| <b>Overspill protection</b>              | WHG   |
| <b>External standards and guidelines</b> | Compliance with external standards and guidelines in the design and development of the Nivotester FTL 325 P. <ul style="list-style-type: none"> <li>• EN 60529<br/>Type of ingress protection for housing (IP Code)</li> <li>• EN 61010<br/>Safety specifications for electrical measurement, control and laboratory instruments</li> <li>• EN 61326<br/>Interference emission (Class B apparatus), interference immunity (Appendix A - Industry)</li> <li>• IEC 61508<br/>Functional safety of safety-relevant electrical/electronic/programmable electronic systems (E/E/PES)<br/>DIN V 19250<br/>Fundamental Safety aspects for measurement and control equipment</li> </ul> |
| <b>Functional safety</b>                 | SIL1 / SIL2 / SIL3 or Ak 2...6 connected with FEL 57 for protection functions as overspill protection!  |

## Ordering information

|                             |           |   |  |
|-----------------------------|-----------|---|--|
| <b>Nivotester FTL 325 P</b> | <b>10</b> | <b>Certificates</b>                                     |  |
|                             |           | F   | ATEX II (1) GD [EEx ia] IIC, Overspill protection to WHG                   |
|                             |           | H   | ATEX II (1) GD [EEx ia] IIC, Overspill protection to WHG, SIL2 (IEC 61508) |
|                             |           | O   | FM IS Cl. I, II, III Div.1 Group A-G                                       |
|                             |           | P   | FM IS Cl. I, II, III Div.1 Group A-G, SIL2 (IEC 61508)                     |
|                             | S         | CSA IS Cl. I, II, III Div.1 Group A-G                   |  |
|                             | T         | CSA IS Cl. I, II, III Div.1 Group A-G, SIL2 (IEC 61508) |  |
|                             | V         | * TIIS, Ex ia IIC                                       |  |
|                             | W         | * TIIS, Ex ia IIC, SIL2 (IEC 61508)                     |  |
|                             | <b>20</b> | <b>Version</b>  |  |
|                             |           | 1   | Top-hat rail installation 1-channel 22.5 mm                                |
|                             |           | 3   | Top-hat rail installation 3-channel 45 mm                                  |
|                             |           | 9   | Special design   |
|                             | <b>30</b> | <b>Voltage supply</b>                                   |  |
|                             |           | A   | Power supply 85... 253 V AC, 50/60 Hz                                      |
|                             |           | E   | Power supply 20... 30 V AC / 20... 60 V DC                                 |
|                             |           | Y   | Special design   |
|                             | <b>40</b> | <b>Output</b>   |  |
|                             |           | 1   | 1x level SPDT + 1x alarm SPST  |
|                             |           | 3   | 3x level SPDT + 1x alarm SPST  |
|                             |           | 9   | Special design   |
|                             | FTL 325 P |   | Complete product designation   |

---

## Accessories

---

### Protective housing

The protective housing of ingress protection class IP66 is equipped with an integrated top-hat rail and is closed by a transparent cover which can also be lead-sealed.

#### Dimensions:

W 180 / H 182 / D 165

#### Colour:

Light grey RAL 7035

Parts number (PN) 52010132

## Supplementary documentation

---

### System Information (SI)

- Liquiphant M  
SI 040F/00/en

### Technical Information (TI)

- Liquiphant M  
FTL 50/51, FTL 50H/51 H  
Measuring sensor for level limit detection in liquids  
TI 328F/00/en
- Liquiphant M  
FTL 51 C  
Measuring sensor for level limit detection in liquids  
with highly corrosion-resistant coating  
TI 347F/00/en
- Liquiphant S (Hochtemperatur)  
FTL 70/71  
Measuring sensor for level limit detection in liquids  
for measuring medium temperatures of up to 280 °C  
TI 354F/00/en
- Protective housing  
TI 367F/00/en

### Operating Instructions (KA)

#### 1-channel:

- Nivotester  
FTL 325 P-#1#1  
Level limit switch with PFM input  
KA 167F/00/a6

#### 3-channel:

- Nivotester  
FTL 325 P-#3#3  
Level limit switch with PFM input  
KA 168F/00/a6

### Functional safety

#### 1-channel:

- Nivotester  
FTL 325 P-#1#1  
SD 111F/00/en

#### 3-channel:

- Nivotester  
FTL 325 P-#3#3  
SD 111F/00/en

---

**Certificates****ATEX:**

- Nivotester  
FTL 325 P  
XA 133F/00/a3

**DIBt:**

- Liquiphant M, Liquiphant S  
FTL 50/51, FTL 50H/51 H, FTL 51 C, FTL 70/71  
ZE 233F/00/de

**SIL:**

- Nivotester  
SD 111F/00/en

---

---

**Endress+Hauser GmbH+Co.**

Instruments International  
P.O. Box 2222  
D-79574 Weil am Rhein  
Germany

Tel. (07621) 975-02  
Tx 773926  
Fax (07621) 975 345  
e-mail: [info@ii.endress.com](mailto:info@ii.endress.com)

**Internet:**

<http://www.endress.com>

**Endress + Hauser**  
The Power of Know How

