

High Performance Multifunctional Inverters

# **FRENIC-MEGA** Series



## **FUJI INVERTERS**

*With the flexibility and functionality to support a wide range of applications on all types of mechanical equipment, the FRENIC-MEGA takes core capability, responsiveness, environmental awareness, and easy maintenance to the next level.*



# The performance, reaching the peak in the industry

FRENIC-MEGA is a high performance, multifunctional inverter  
Fuji Electric has developed by gathering the best of its technologies.  
With our own state-of-the-art technology, the control performance has evolved to a new dimension.

FRENIC-MEGA has been developed to use with a variety of equipment  
by improving the basic performance,  
meeting the requirements for various applications, achieving lower maintenance,  
and enhancing the resistance to the environmental impacts.

FRENIC-MEGA, the inverter with the highest performance in the industry,  
is about to redefine the common sense of general-purpose inverters.  
Now, it is ready to answer your needs.

## FRENIC MEGA

Maximum Engineering for Global Advantage

### FUJI INVERTERS

*With the flexibility and functionality to support a wide range of applications on all types of mechanical equipment, the FRENIC-MEGA takes core capability, responsiveness, environmental awareness, and easy maintenance to the next level.*

Two types of keypads are available for FRENIC-MEGA: the multi-function keypad and the keypad with USB port. You can select and use the keypad that meets your application needs.



FRENIC-MEGA  
+  
Multi-function keypad



FRENIC-MEGA  
+  
Keypad with USB port

# High Performance Multifunctional Inverters

## **FRENIC-MEGA** Series

Maximum Engineering for Global Advantage

### Improved control performance

- I **Applicable control methods: PG vector control, sensorless vector control, dynamic torque vector control, and V/f control**
- II **Improved performance of current response and speed response** (vector control)
- III **Improved durability in overload operation**
  - HD (High duty) spec: 200% for 3 sec / 150% for 1 min  
: For general industry applications
  - MD (Middle duty) spec: 150% for 1 min  
: For constant torque applications
  - LD (Low duty) spec: 120% for 1 min  
: For fans and pumps applications

### Easy maintainance

- I **Keypad with a USB connector(option)**
- II **A multi-function keypad(option)**
- III **Maintenance warning signal output**
- IV **Use of parts of a longer life cycle (Designed life: 10 years)**  
(Main circuit capacitor, electrolytic capacitor, cooling fan)



### Various applications

- I **Various functions that accommodate a wide range of applications**  
Example: Breakage detection by braking transistor, improved reliability of brake signals, and operation at a specified ratio
- II **Expanded capacity of the brake circuit built-in model**  
(Standard-equipped for 22kW or smaller models)
- III **Various network support**

### Environmental adaptation

- I **Great model variation meeting customers' needs**  
-EMC filter built-in type  
-Without EMC filter (Basic type)
- II **Compliance with RoHS Directives (planned)**
- III **Improved resistance to the environmental impact**



### Safety Precautions

1. Use the contents of this catalog only for selecting product types and models. When using a product, read the Instruction Manual beforehand to use the product correctly.
2. Products introduced in this catalog have not been designed or manufactured for such applications in a system or equipment that will affect human bodies or lives. Customers, who want to use the products introduced in this catalog for special systems or devices such as for atomic-energy control, aerospace use, medical use, and traffic control, are requested to consult the Fuji's Sales Division. Customers are requested to prepare safety measures when they apply the products introduced in this catalog to such systems or facilities that will affect human lives or cause severe damage to property if the products become faulty.

# Best vector control for the general-purpose inverter in the class

## Ideal for highly accurate control such as positioning

### PG vector control

Effective in providing highly accurate control for applications such as printing press

Speed control range: 1:1500  
 Speed response: 100Hz  
 Speed control accuracy:  $\pm 0.01\%$   
 Current response: 500Hz  
 Torque accuracy:  $\pm 10\%$

\* The option card is required separately.

\* The above specifications may vary depending on the environment or conditions for use.

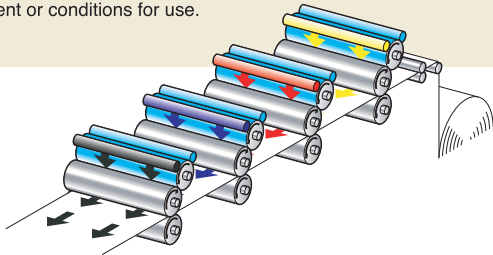

## Maximizing the performance of a general-purpose motor

### Speed sensor-less vector control

Useful for the application that requires a high starting torque, such as the gondola type multi-level car parking tower

Speed control range: 1:200  
 Speed response: 20Hz  
 Speed control accuracy:  $\pm 0.5\%$   
 Current response: 500Hz  
 Torque accuracy:  $\pm 10\%$

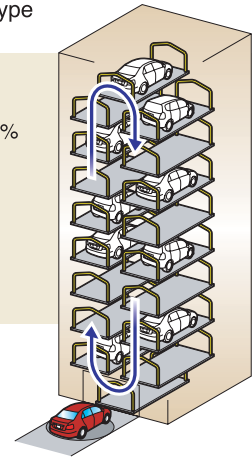

## Fuji's original dynamic torque vector control has further evolved.

Besides the dynamic torque vector control, the inverter is equipped with the motor constant tuning for compensating even a voltage error of the main circuit devices and the magnetic flux observer of a new system. This realizes a high starting torque of 200% even at a low-speed rotation of 0.3Hz.

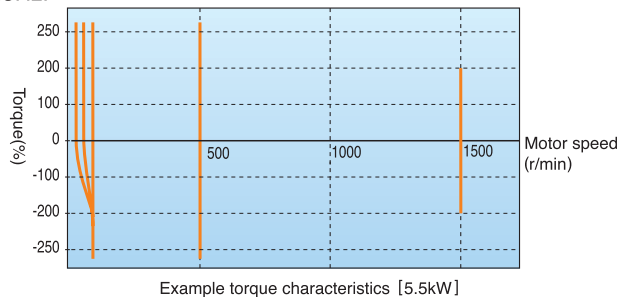

## Improved durability in overload operation

The inverter performs short-time acceleration and deceleration with the maximum capacity by extending the time specification of overload current ratings compared with our previous models. This improves the operation efficiency of the equipment such as cutting machine or conveyance machine.

Overload durability: 200% for 3 sec and 150% for 1 min.

The standard model is available in two specifications concerning the operation load.

Classification	Overload current rating	Major use
HD (High duty) spec	200% for 3 sec, 150% for 1 min	Operation under heavy load
MD (Middle duty) spec	150% for 1 min	Operation under constant torque load
LD (Low duty) spec	120% for 1 min	Operation under light load

## Expanded capacity for the braking circuit built-in type

A braking circuit is built in the 22kW or smaller models as standard. These inverters are applicable to the machine that uses regenerative load such as a vertical conveyance machine.

(The 7.5kW or smaller models also incorporate a braking resistor.)

\* The inverters with built-in braking circuit are available on request for 30kW to 110kW models in 400V series.

## Improved reaction to the fluctuation of impact load

When a remarkable load fluctuation occurs, the inverter provides the torque response in the class-top level. It controls the flux to minimize the fluctuation in the motor speed while suppressing the vibration. This function is best suited for the equipment that requires stable speed such as a cutting machine.

Example:

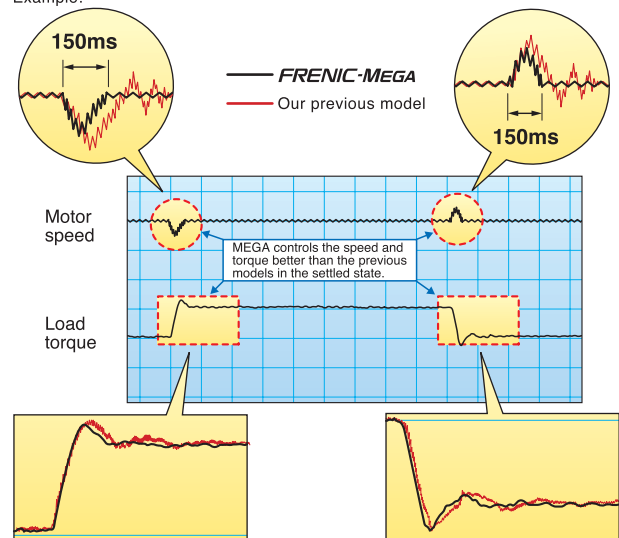

## Quicker response to the operation commands

The terminal response to the operation commands has had an established reputation. FRENIC-MEGA has further shortened this response time, achieving the industry-top response time.

This function is effective in shortening the tact time per cycle and effective for use in the process including frequent repetitions.

Example:

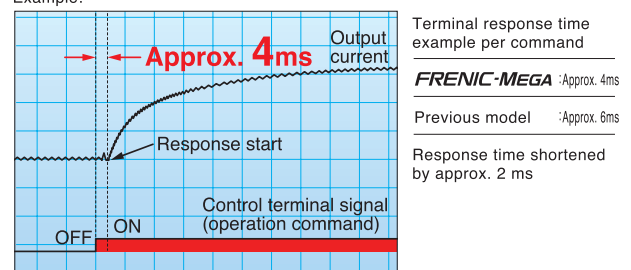

## Accommodating various applications

### Convenient function for operations at the specified speed

The pulse train input function is equipped as standard.

It is possible to issue the speed command with the pulse train input (single-phase pulse and a sign of command value) from the pulse generator, etc.  
(Maximum pulse input: 100kHz)

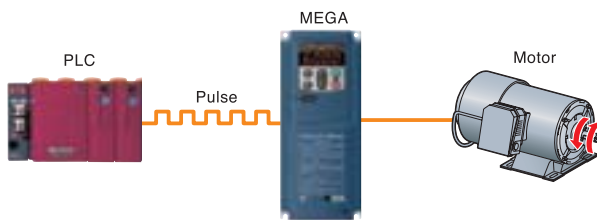

### Ratio operation

The ratio operation is the function particularly convenient for adjusting two or more conveyance systems. The ratio of the main axis speed to the two or more trailing axes can be set as a frequency command. On the machine that handles load variation such as a conveyance machine, the conveyance speed can be adjusted easily.

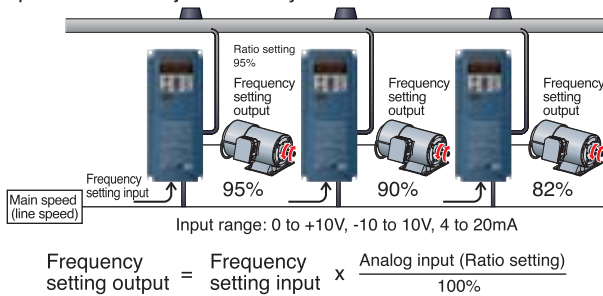

### Thorough protection of the braking circuit

The inverter protects the braking resistor by monitoring the braking transistor operation. **The inverter outputs an exclusive signal on detection of the braking transistor abnormality.** A circuit for shutting off the input power supply is provided outside of the inverter. When this signal is output, the power is shut off; thus protecting the braking circuit.

## MEGA World Keeps Expanding

### PG option card for positioning control

This control function is best suited for the application that requires highly accurate positioning such as that of the conveyance machine. By combined use of the position control device (APR) and PG vector control, the position control accuracy has been remarkably improved. Shortened positioning time by this function will be helpful to reduce the tact time of a cycle.

Example: Fixed length marking system

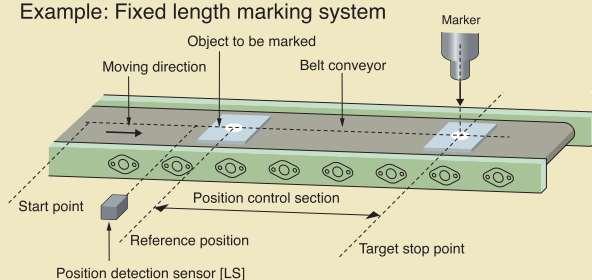

### Optimum function for preventing an object from slipping down

The reliability of the brake signal was increased for uses such as vertical conveyance. Conventionally, the current value and the frequency have been monitored when the brake signal is output. By adding a torque value to these two values, the brake timing can be adjusted more easily.

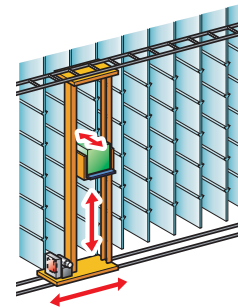

### Dancer control function optimum for winding control

The PID value, calculated by comparing the target value and the feedback value, is added to or subtracted from the reference speed. Since the PID calculator gain (in proportional range) can be set to a low value, the inverter can be applied to the automatic control system that requires quick response such as a speed controller.

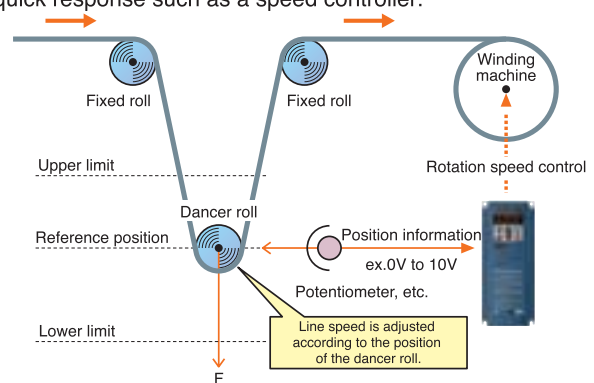

### More functions are available to meet various requirements

(1) Analog inputs: voltage input through 2 terminals with polarity, current input through 1 terminal (2) Slow flowrate level stop function (Pressurized operation is possible before slow flowrate operation stop.) (3) Non-linear V/f pattern at 3 points (4) Dummy failure output function (5) Selection of up to the 4th motor (6) S-shape accel./decel. range setting (7) Detecting disconnection of the PID feedback

The customized logic interface function is adopted in the inverter body. (Available soon)

Logic input/output can be easily created by parameter setting. This makes it possible to simplify the peripheral circuits.

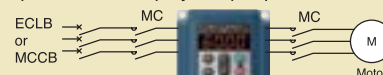

The interface is available in 10 steps using 2 inputs, 1 output, logical operation, and the timer function.

Introducing servo lock function (PG option card). (Available soon)

This function is effective in adjusting the stop timing or the braking torque when the equipment such as a conveyance machine is stopped by positioning of the motor. This function is helpful when torque is applied externally or holding torque is required during the stop time. The tact time per cycle will be reduced by shortened deceleration time.

## Wide model variation meeting the customer needs

### Wide model variation

#### 1. EMC filter built-in type

By adopting built-in filter, this type is compliant with European EMC Directives category C3 (2nd Env) EN50178

#### 2. Without EMC filter (Basic type)

Suitable for the equipment that uses a peripheral device to suppress noise or harmonics.



## Supports for simple maintenance

You can select the keypad suitable for your application, which improves usability.

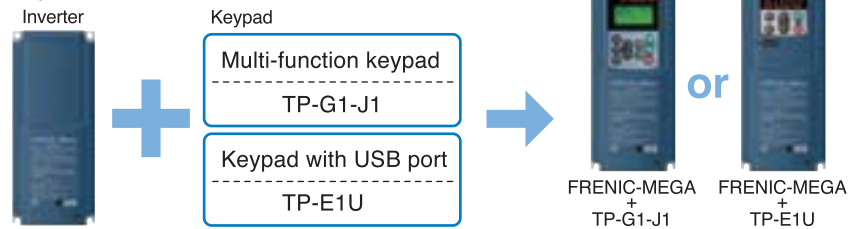

### Multi-function keypad Type: OPC-G1-J1 (Option)

#### Features

- Back-lighted LCD with higher view-ability
- A large 7-segment LED with 5-digit display
- Quick setup data item can be added/deleted.
- Remote/local switch key has been newly added.
- Max. 3 sets of data can be copied.
- Display languages:
  - TP-G1-J1: English, German, French, Spanish, Italian and Japanese



### Keypad with USB port Type: TP-E1U (Option)

- The built-in USB port allows use of a personal computer loader for easy information control!

#### Improved working efficiency in the manufacturing site

- A variety of data about the inverter body can be saved in the keypad memory, allowing you to check the information in any place.

#### Example of use in the office



- Data can be transferred from the USB port of the keypad directly to the computer (personal computer loader) in the manufacturing site.
- Periodical collection of life information can be carried out efficiently.
- The real-time tracing function permits the operator to check the equipment for abnormality.

#### Example of use in the manufacturing site



#### Features

1. The keypad can be directly connected to the computer through a commercial USB cable (Mini B) without using a converter. The computer can be connected on-line with the inverter.
2. With the personal computer loader, the inverter can support the following functions (1) to (5).
  - (1) Editing, comparing, and copying the function code data
  - (2) Operation monitor, and real-time trace
  - (3) Trouble history (indicating the latest four troubles)
  - (4) Maintenance information
  - (5) Historical trace

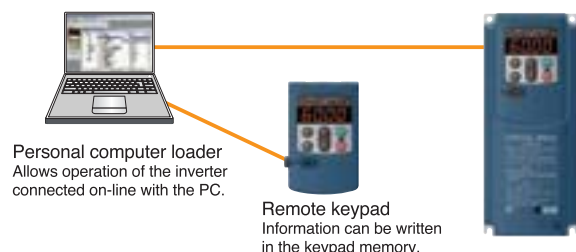

## Network building

### Connection with the network with the option card

#### ON sale

- DeviceNet
- CC-Link
- PROFIBUS DP
- CANopen
- T-Link interface card

#### Available soon

- SX bus interface card etc.

### Advanced network function

#### RS-485 communication is possible as a standard function (terminal base).

Besides the port (RJ-45 connector) shared with the keypad, RS-485 terminal is provided as a standard function. Since the interface is connected through terminals, multi-drop connection can be made easily.

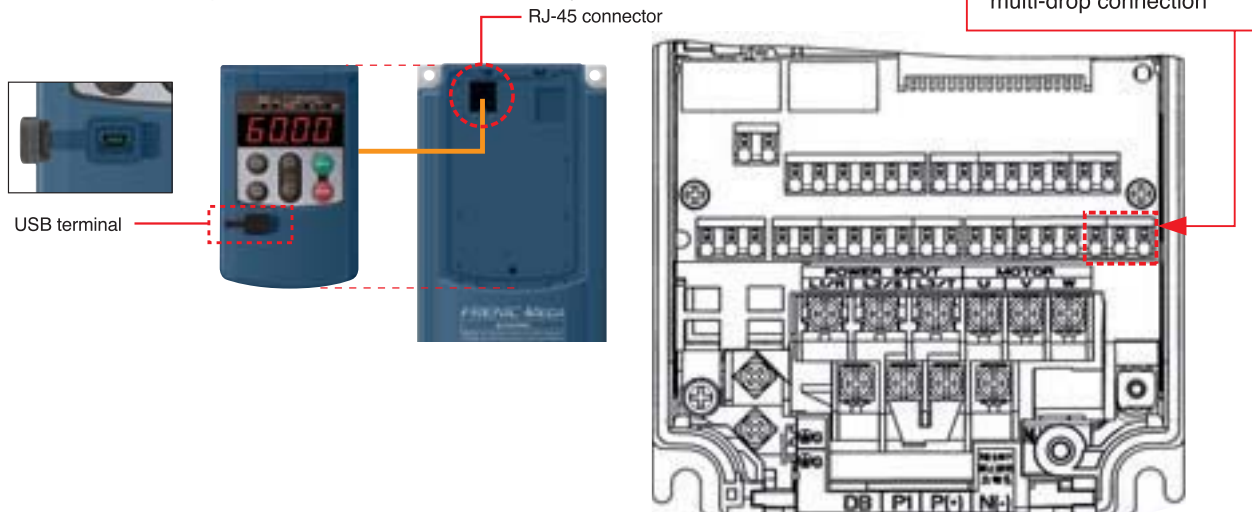

## Prolonged service life and improved life judgment function

### Designed life 10 years

For the various consumable parts inside the inverter, their designed lives have been extended to 10 years, which also extended the equipment maintenance cycles.

Consumable part	Designed life
Main circuit capacitor	10 years
Electrolytic capacitor on PCB	10 years
Cooling fan	10 years

**The part life condition that the inverter is used at:**  
an ambient air temperature of 40°C and under the load rate of 100% (HD spec) or 80% (LD spec)

\* The designed lives are the calculated values and not the guaranteed ones.

### Full support of life warnings

The inverter is loaded with the functions for facilitating the maintenance of the equipment

Item	Purpose
Cumulative inverter run time (h)	Displays the total run time of the inverter.
Number of inverter startups	Displays the number of times the inverter has started the equipment. <b>Example of use:</b> This data indicates the timing to replace the equipment parts (such as a timing belt) operating under the normal load.
Equipment maintenance warning Cumulative run time (h) Number of startups	By inputting the signal for operation with the commercial power supply, the time outside the inverter operation time can also be measured. This makes it possible to manage the total run time of the equipment and the number of startups. Such data is usable for preparing the maintenance schedule.
Display of inverter life warning	The displayed contents include: main circuit capacitor capacity, total run time of the cooling fan (with ON/OFF compensation), total run time of the electrolytic capacitor on the printed circuit board, and total run time of the inverter.

## Consideration for environment

### Enhanced resistance to the environmental impacts

Resistance to the environmental impact has been enhanced compared with the conventional inverter.

- (1) Enhanced durability of the cooling fan operated under the environmental impact
- (2) Adoption of copper bars plated with nickel or tin

In MEGA, resistance to the environmental impact has been increased compared with the conventional model (FRENIC5000 G11S/P11S). However, examine the use of the inverter carefully according to the environment in the following cases:

- a. Environment is subject to sulfide gas (at tire manufacturer, paper manufacturer, sewage disposer, or part of the process in textile industry).
- b. Environment is subject to conductive dust or foreign matters (in metalworking, operation using extruding machine or printing machine, waste disposal).
- c. Others: The inverter is used in the environment of which specification exceeds the specified range.

If you are examining use of the inverter under the above conditions, consult the Fuji's Sales Division regarding the models with enhanced durability.

### Compliance with RoHS Directives

MEGA complies with European regulations that limit the use of specific hazardous substances (RoHS) as a standard. This inverter is environment-friendly as the use of the following six hazardous substances is restricted.

<Six hazardous substances>

Lead, mercury, cadmium, hexavalent chromium, polybrominated biphenyl (PBB), and polybrominated biphenyl ether (PBDE)

\* Except the parts of some inverter models

<About RoHS>

The Directive 2002/96/EC, promulgated by the European Parliament and European Council, limits the use of specific hazardous substances included in electrical and electronic devices.

### Protection against micro surge

#### Surge suppression unit (optional)

If the motor drive cable between the inverter and the battery is long, a very thin surge voltage (micro surge) is generated at the motor connection ends. This surge voltage causes deterioration of the motor, dielectric breakdown, or increase in noise. The surge suppression unit suppresses this surge voltage.

- (1) The surge voltage can be significantly suppressed simply by connecting the surge suppression unit to the motor.
- (2) Since no additional work is required, it can be easily mounted on the existing equipment.
- (3) The unit is applicable to the motors regardless of their capacity.
- (4) The unit requires no power source and no maintenance.
- (5) The cable comes in two lengths depending on the require cable length between the inverter and the motor: 50m and 100m.
- (6) Compliant with environmental standard and safety standard (Compliant with RoHS Directives, and application to UL standard pending).



#### Surge suppression unit structure

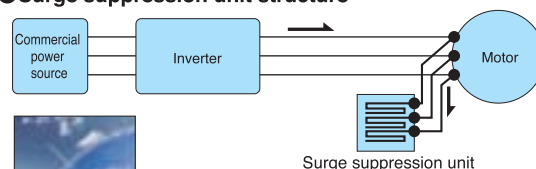

MEH654

See the surge suppression unit catalog (MEH654) for details.

## Global compatibility

### Application to the world standards pending

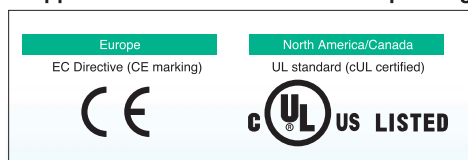

### Wide voltage range

Applicable to 480V and 240V power supplies as standard





# Model Variations

**Model list** HD : High Duty spec 200% for 3 sec, 150% for 1min  
MD : Middle Duty spec 150% for 1min  
LD : Low Duty spec 120% for 1 min

Standard applied motor (kW)	EMC filter built-in type			Without EMC filter (Basic type)		
	3-phase 400 V series			3-phase 400 V series		
	HD spec (150%)	MD spec (150%)	LD spec (120%)	HD spec (150%)	MD spec (150%)	LD spec (120%)
0.4	FRN0.4G1E-4E			FRN0.4G1S-4E		
0.75	FRN0.75G1E-4E			FRN0.75G1S-4E		
1.5	FRN1.5G1E-4E			FRN1.5G1S-4E		
2.2	FRN2.2G1E-4E			FRN2.2G1S-4E		
4.0	FRN4.0G1E-4E			FRN4.0G1S-4E		
5.5	FRN5.5G1E-4E			FRN5.5G1S-4E		
7.5	FRN7.5G1E-4E		FRN5.5G1E-4E	FRN7.5G1S-4E		FRN5.5G1S-4E
11	FRN11G1E-4E		FRN7.5G1E-4E	FRN11G1S-4E		FRN7.5G1S-4E
15	FRN15G1E-4E		FRN11G1E-4E	FRN15G1S-4E		FRN11G1S-4E
18.5	FRN18.5G1E-4E		FRN15G1E-4E	FRN18.5G1S-4E		FRN15G1S-4E
22	FRN22G1E-4E		FRN18.5G1E-4E	FRN22G1S-4E		FRN18.5G1S-4E
30	FRN30G1E-4E		FRN22G1E-4E	FRN30G1S-4E		FRN22G1S-4E
37	FRN37G1E-4E		FRN30G1E-4E	FRN37G1S-4E		FRN30G1S-4E
45	FRN45G1E-4E		FRN37G1E-4E	FRN45G1S-4E		FRN37G1S-4E
55	FRN55G1E-4E		FRN45G1E-4E	FRN55G1S-4E		FRN45G1S-4E
75	FRN75G1E-4E		FRN55G1E-4E	FRN75G1S-4E		FRN55G1S-4E
90	FRN90G1E-4E		FRN75G1E-4E	FRN90G1S-4E		FRN75G1S-4E
110	FRN110G1E-4E	FRN90G1E-4E	FRN90G1E-4E	FRN110G1S-4E	FRN90G1S-4E	FRN90G1S-4E
132	FRN132G1E-4E	FRN110G1E-4E	FRN110G1E-4E	FRN132G1S-4E	FRN110G1S-4E	FRN110G1S-4E
160	FRN160G1E-4E	FRN132G1E-4E	FRN132G1E-4E	FRN160G1S-4E	FRN132G1S-4E	FRN132G1S-4E
200	FRN200G1E-4E	FRN160G1E-4E	FRN160G1E-4E	FRN200G1S-4E	FRN160G1S-4E	FRN160G1S-4E
220	FRN220G1E-4E	FRN200G1E-4E	FRN200G1E-4E	FRN220G1S-4E	FRN200G1S-4E	FRN200G1S-4E
250		FRN220G1E-4E			FRN220G1S-4E	
280	FRN280G1E-4E		FRN220G1E-4E	FRN280G1S-4E		FRN220G1S-4E
315	FRN315G1E-4E	FRN280G1E-4E		FRN315G1S-4E	FRN280G1S-4E	
355	FRN355G1E-4E	FRN315G1E-4E	FRN280G1E-4E	FRN355G1S-4E	FRN315G1S-4E	FRN280G1S-4E
400	FRN400G1E-4E	FRN355G1E-4E	FRN315G1E-4E	FRN400G1S-4E	FRN355G1S-4E	FRN315G1S-4E
450			FRN355G1E-4E			FRN355G1S-4E
500	FRN500G1E-4E	FRN400G1E-4E	FRN400G1E-4E	FRN500G1S-4E	FRN400G1S-4E	FRN400G1S-4E
630	FRN630G1E-4E		FRN500G1E-4E	FRN630G1S-4E		FRN500G1S-4E
710			FRN630G1E-4E			FRN630G1S-4E

  
  
   Available soon

## How to read the inverter model

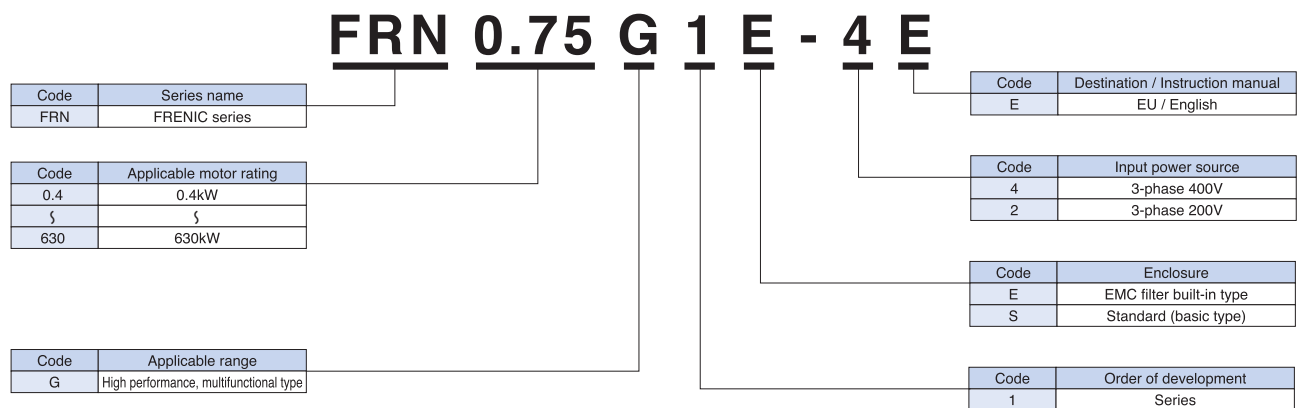

\*The keypad is not included as standard equipment for inverters. Please select and use either (1) multi-function keypad (TP-G1-J1) or (2) remote control keypad (TP-E1U) as option.

\*The DC reactor is not included as standard equipment for inverters. Please select and use the optional DC reactor listed on page 42 in this catalog.

**Caution** The contents of this catalog are provided to help you select the product model that is best for you. Before the actual use, be sure to read the User's Manual thoroughly for proper operations.

Characteristics  
 Model Variations  
 Keyboard Operations  
 Inverter Support Load  
 Standard Specifications  
 Common Specifications  
 Basic Wiring Diagram  
 Terminal Functions  
 Function Settings  
 External Dimensions  
 Options  
 Warranty  
 Variations

# Keypad Operations

## Keypad switches and functions

### 6000 LED monitor

4-digit, 7-segment LED monitor  
The following data is displayed in each operation mode.

- Run mode : Operation information (output frequency, output current, output voltage, etc.) When a minor trouble occurs, the monitor shows a minor trouble warning **L-RL**.
- Program mode : Menu, function code, function code data, etc.
- Alarm mode : Alarm code indicating the cause that triggered the protection function.

### Program/Reset key

Used to change the operation mode.

- Run mode : Press the key to switch the program mode.
- Program mode : Press the key to switch the run mode.
- Alarm mode : After solving the problem, press this key to turn off the alarm and switch to the run mode.

### Function/Data key

Use this key for the following operations.

- Run mode : Press the key to switch the operation status information to be displayed (output frequency, output current and output voltage). When a minor trouble warning is displayed, holding down this key resets the alarm and switches back to Running mode.
- Program mode : Press the key to display the function code or establish data.
- Alarm mode : Press the key to display the detailed alarm information.

### Keypad control LED

This LED is on when the **PRG** key on the keypad is enabled and can issue an operation command. In the program mode or alarm mode, however, no operation is possible even if this LED is lit.

### x10 LED

If the data to be displayed exceeds 9999, the x10 LED lights, indicating that the actual data is ten times the displayed data.

Example: If the data is "12,345," the LED monitor displays "1234," and the "x10 LED" appears at the same time, indicating that the actual value is 1,234 x 10 = 12,340.

### Unit LED (3 places)

r/min | m/min

■ Hz □ A □ kW

Combination of the three LEDs shows the unit used when the operating condition is monitored in the run mode.

### PRG. MODE

When the program is selected, the right and left LEDs are on.

■ Hz □ A ■ kW

### RUN LED

This LED is on during operation with **RUN** key, FWD/REV signal or with communication operation command.

### RUN key

Starts the motor operation.

### STOP key

Stops the motor operation.

### Up/Down key

Used to select the setting items displayed on the LED monitor or change the function mode data.



### USB port

Enables connection of the inverter with the PC using USB cable. The inverter side connector is of the mini B-type.

## Monitor display and key operation

The keypad modes are classified into the following 3 modes.

Monitor, keys	Operation mode		Programming mode		Running mode		Alarm mode
	STOP	RUN	STOP	RUN	STOP	RUN	
<b>Monitor</b>  <input type="checkbox"/> PRG. MODE <input type="checkbox"/> r/min <input type="checkbox"/> m/min <input type="checkbox"/> Hz <input type="checkbox"/> A <input type="checkbox"/> kW	Function	Displays the function code and data.		Displays the output frequency, set frequency, loaded motor speed, power consumption, output current, and output voltage.		Displays the alarm description and alarm history.	
	Display	Lighting		Blinking		Lighting	
	Function	Indicates that the program mode is selected.		Displays the units of frequency, output current, power consumption, and rotation speed.		None	
	Display	<input type="checkbox"/> PRG. MODE <input type="checkbox"/> r/min <input type="checkbox"/> m/min <input type="checkbox"/> Hz <input type="checkbox"/> A <input type="checkbox"/> kW		<input type="checkbox"/> PRG. MODE <input type="checkbox"/> r/min <input type="checkbox"/> m/min <input checked="" type="checkbox"/> Hz <input type="checkbox"/> A <input checked="" type="checkbox"/> kW ON		<input type="checkbox"/> PRG. MODE <input type="checkbox"/> r/min <input type="checkbox"/> m/min <input checked="" type="checkbox"/> Hz <input checked="" type="checkbox"/> A <input type="checkbox"/> kW ON	
<input type="checkbox"/> KEYPAD CONTROL  <input type="checkbox"/> RUN	Function	Operation selection (keypad operation/terminal operation) is displayed.					
	Display	Lit in keypad operation mode					
	Function	Indicates absence of operation commands.	Indicates presence of operation commands.	Indicates absence of operation commands.	Indicates presence of operation commands.	Indicates that the operation is trip-stopped.	
<b>Keys</b>     	Function	Switches to running mode		Switches to programming mode.		Releases the trip and switches to stop mode or running mode.	
	Function	Digit shift (cursor movement) in data setting					
	Function	Determines the function code, stores and updates data.		Switches the LED monitor display.		Displays the operation information.	
	Function	Increases/decreases the function code and data.		Increases/decreases the frequency, motor speed and other settings.		Displays the alarm history.	
	Function	Invalid		Starts running (switches to running mode (RUN)).	Invalid	Invalid	
Function	Invalid	Deceleration stop (switches to programming mode (STOP)).	Invalid	Deceleration stop (switches to running mode (STOP)).	Invalid		

# Inverter Support Loader

## Full-fledged maintenance with the FRENIC loader

- Editing, comparing and copying the function code data
- Operation monitor, real-time historical trace, trouble monitor, and multi-monitor
- Test run, motor auto tuning

- Operation of Windows2000 and XP is guaranteed.
- The real-time trace function monitors the inverter operating conditions with the waveforms in the multi-channel graph format, and the results can be stored in a data file. The stored data can be used for motion analysis etc.

\* The loader software can be downloaded for free from FUJI's website.

FCS URL(<http://www.fujielectric.co.jp/fcs/jpn/>)→Technical Information→Drive Control Equipment→Inverters→Software libraries

### Function code list editing

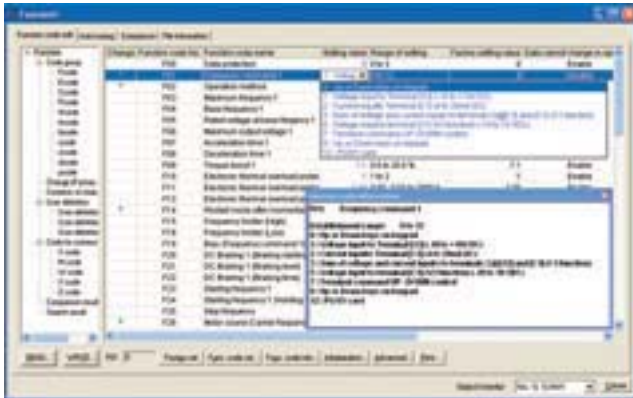

### Historical trace

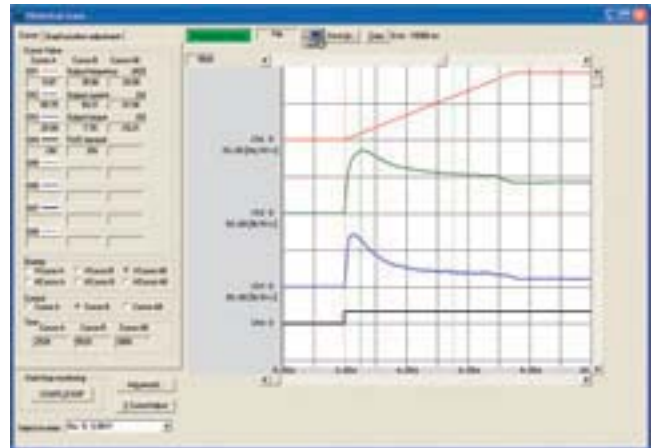

### Operation monitor



### Test run screen



### Maintenance information

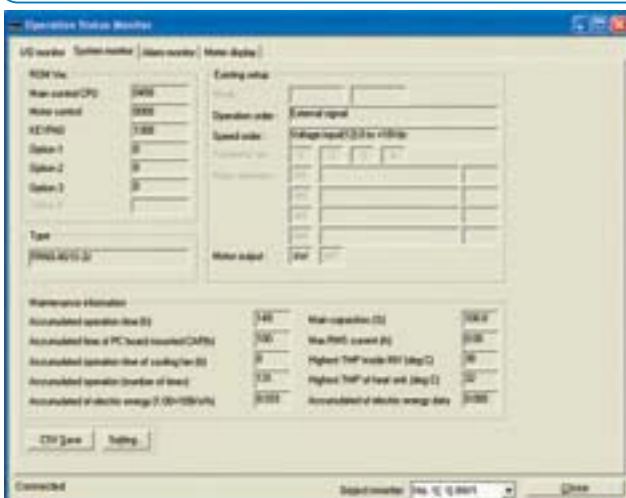

Characteristics

Model Variations

Keypad Operations

Inverter Support Loader

Standard Specifications

Common Specifications

Basic Wiring Diagram

Terminal Functions

Function Settings

External Dimensions

Options

Warranty

Variations

# EMC filter built-in type

## Three-phase 400V series

### (0.4 to 55kW) HD (High Duty) spec for heavy load

Item		Specifications																							
Type (FRN□□□G1E-4E)		0.4	0.75	1.5	2.2	4.0	5.5	7.5	11	15	18.5	22	30	37	45	55									
Output ratings	Nominal applied motor [kW] (*1)	0.4	0.75	1.5	2.2	4.0	5.5	7.5	11	15	18.5	22	30	37	45	55									
	Rated capacity [kVA] (*2)	1.1	1.9	2.8	4.1	6.8	10	14	18	24	29	34	45	57	69	85									
	Rated voltage [V] (*3)	Three-phase 380 to 480V (with AVR)																							
	Rated Current [A]	1.5	2.5	4	5.5	9	13.5	18.5	24.5	32	39	45	60	75	91	112									
	Overload capability	150% for 1min, 200% for 3.0s																							
Input ratings	Rated frequency [Hz]	50, 60Hz																							
	Main circuit power Phases, voltage, frequency	Three-phase 380 to 480V, 50/60Hz																							
	Auxiliary control power input Phases, voltage, frequency	—		Single-phase 380 to 480V, 50/60Hz																					
	Auxiliary power input for fan Phases, voltage, frequency (*5)	—																							
	Voltage, frequency variations	Voltage:+10 to -15% (Voltage unbalance:2% or less (*6)) Frequency:+5 to -5%																							
Braking	Rated current [A] (*7)	with DCR	0.85	1.6	3.0	4.5	7.5	10.6	14.4	21.1	28.8	35.5	42.2	57.0	68.5	83.2	102								
	without DCR	1.7	3.1	5.9	8.2	13.0	17.3	23.2	33	43.8	52.3	80.6	77.9	94.3	114	140									
	Required power supply capacity [kVA] (*8)	with DCR	0.6	1.2	2.1	3.2	5.2	7.4	10	15	20	25	30	40	48	58	71								
Braking	Torque [%] (*9)	150%			100%			20%			10 to 15%														
	Braking transistor	Built-in																							
	Min. ohmic value [Ω]	200			180			96			64			48			32			24			16		
	Torque [%]	180%			180%			180%			180%			180%			180%								
	Built-in braking resistance	720Ω		470Ω		160Ω			80Ω			—													
	Braking time[s]	5s																							
%ED	5			3			5			3			2			3			2						
DC injection braking	Starting frequency:0.0 to 60.0Hz, Braking time: 0.0 to 30.0s, Braking level:0 to 100%																								
EMC filter	EMC standard compliance: Category C3 is only emission and 2nd Env. is immunity. (EN61800-3:2004)																								
DC reactor (DCR) (*10)	Optional																								
Applicable safety standards	UL508C, C22.2No.14, EN50178:1997																								
Enclosure (IEC60529)	IP20(IEC60529) closed type, UL open type (UL 50)											IP00 open type, UL open type													
Cooling method	Natural cooling					Fan cooling																			
Weight/Mass [kg]	1.8	2.1	2.7	2.9	3.2	6.8	6.9	6.2	10.5	10.5	11.2	26	27	32	33										

### (75 to 630kW) HD (High Duty) spec for heavy load

Item		Specifications															
Type (FRN□□□G1E-4E)		75	90	110	132	160	200	220	280	315	355	400	500	630			
Output ratings	Nominal applied motor [kW] (*1)	75	90	110	132	160	200	220	280	315	355	400	500	630			
	Rated capacity [kVA] (*2)	114	134	160	192	231	287	316	396	445	495	563	731	891			
	Rated voltage [V] (*3)	Three-phase 380 to 480V (with AVR)															
	Rated Current [A]	150	176	210	253	304	377	415	520	585	650	740	960	1170			
	Overload capability	150% for 1min, 200% for 3.0s															
Input ratings	Rated frequency [Hz]	50, 60Hz															
	Main circuit power Phases, voltage, frequency	Three-phase 380 to 440V/50Hz Three-phase 380 to 480V/60Hz															
	Auxiliary control power input Phases, voltage, frequency	Single-phase 380 to 480V, 50/60Hz															
	Auxiliary power input for fan Phases, voltage, frequency (*5)	Single-phase 380 to 440V/50Hz Single-phase 380 to 480V/60Hz															
	Voltage, frequency variations	Voltage:+10 to -15% (Voltage unbalance:2% or less (*6)) Frequency:+5 to -5%															
Braking	Rated current [A] (*7)	with DCR	138	164	201	238	286	357	390	500	559	628	705	881	1115		
	without DCR	—	—	—	—	—	—	—	—	—	—	—	—	—			
	Required power supply capacity [kVA] (*8)	with DCR	96	114	140	165	199	248	271	347	388	436	489	611	773		
Braking	Torque [%] (*9)	10 to 15%															
	Braking transistor	—															
	Min. ohmic value [Ω]	—															
	Torque [%]	—															
DC injection braking	Starting frequency:0.0 to 60.0Hz, Braking time: 0.0 to 30.0s, Braking level:0 to 100%																
EMC filter	EMC standard compliance: Category C3 is only emission and 2nd Env. is immunity. (EN61800-3:2004)																
DC reactor (DCR) (*10)	Standard accessory																
Applicable safety standards	UL508C, C22.2No.14, EN50178:1997																
Enclosure (IEC60529)	IP00 open type, UL open type																
Cooling method	Fan cooling																
Weight/Mass [kg]	42	62	64	103	103	144	144										

(\*1) Fuji's 4-pole standard motor

(\*2) Rated capacity is calculated by assuming the output rated voltage as 220V for three-phase 200V series and 440V for three-phase 400V series.

(\*3) Output voltage cannot exceed the power supply voltage.

(\*5) The auxiliary power input is used as an AC fan power input when combining the unit such as high power factor PWM converter with power regenerative function. (Generally not used.)

(\*6) Interphase voltage unbalance ratio[%] = (max. voltage [V] - min. voltage [V])/3-phase average voltage [V]×67(See IEC61800-3.) Use the DC reactor (ACR: optional) when used with 2 to 3% of unbalance ratio.

(\*7) The value is calculated on assumption that the inverter is connected with a power supply capacity of 500kVA (or 10 times the inverter capacity if the inverter capacity exceeds 50kVA) and %X is 5%.

(\*8) Obtained when a DC reactor (DCR) is used.

(\*9) Average braking torque obtained by use of a motor. (Varies with the efficiency of the motor.)

(\*10) The 55kW DC reactor (DCR) is optional with HD spec, and is provided as a standard accessory with LD spec.

## Three-phase 400V series

(90 to 400 kW) MD mode designed for middle duty load applications

Item	Specifications													
Type (FRN□□□G1E-4E)	90	110	132	160	200	220	280	315	355	400				
Nominal applied motor [kW] (*2)	110	132	160	200	250	250	315	355	400	450				
Output ratings	Rated capacity [kVA] (*3)	160	192	231	287	356	445	495	563	640				
	Rated voltage [V] (*4)	Three-phase 380 to 480 V (with AVR function)												
	Rated current [A]	210	253	304	377	468	468	585	650	740	840			
Overload capability	150% for 1 min													
Input ratings	Voltage, frequency	Three-phase 380 to 440 V, 50 Hz Three-phase 380 to 480 V, 60 Hz												
	Voltage, frequency variations	Voltage: +10 to -15% (Interphase voltage unbalance: 2% or less) (*6), Frequency: +5 to -5%												
Required capacity with DCR [kVA] (*7)	140	165	199	248	271	308	388	436	489	547				
Braking	Torque [%] (*8)	10 to 15 %												
	Braking transistor	—												
EMC filter	Compliant with EMC Directives, Emission and Immunity: Category C3 (2nd Env.) (EN61800-3:2004)													
DC reactor (DCR)	Option (*9)													
Applicable safety standards	UL508C, C22.2 No.14, EN50178:1997													
Enclosure (IEC60529)	IP00, UL open type													
Cooling method	Fan cooling													
Weight/Mass [kg]	62	64	103	103	144	144								

(\*2) Fuji 4-pole standard motor

(\*3) Rated capacity is calculated by assuming the output rated voltage as 220V for 200V series and 440V for 400V series.

(\*4) Output voltage cannot exceed the power supply voltage.

(\*6) Voltage unbalance[%] = (Max. voltage [V] - Min. voltage [V]) / Three-phase average voltage [V] × 67 (See IEC61800-3.) If this value is 2 to 3 %, use an optional AC reactor (ACR).

(\*7) Required when a DC reactor (DCR) is used.

(\*8) Average braking torque obtained by use of a motor. (Varies with the efficiency of the motor.)

(\*9) A DC reactor (DCR) is an option. However, inverters with a capacity of 75 kW or above require a DCR to be connected. Be sure to connect it to those inverters.

# EMC filter built-in type

## Three-phase 400V series

### (5.5 to 55kW) LD (Low Duty) spec for light load

Item		Specifications															
Type (FRN□□□G1E-4E)		—	—	—	—	—	5.5	7.5	11	15	18.5	22	30	37	45	55	
Nominal applied motor [kW] (*1)		—	—	—	—	—	7.5	11	15	18.5	22	30	37	45	55	75	
Output ratings	Rated capacity [kVA] (*2)	—	—	—	—	—	12	17	22	28	33	45	57	69	85	114	
	Rated voltage [V] (*3)	Three-phase 380 to 480V (with AVR)															
	Rated Current [A]	—	—	—	—	—	16.5	23	30.5	37	45	60	75	91	112	150	
	Overload capability	120% for 1min															
	Rated frequency [Hz]	50, 60Hz															
Input ratings	Main circuit power Phases, voltage, frequency	Three-phase 380 to 480V, 50/60Hz															
	Auxiliary control power input Phases, voltage, frequency	Single-phase 380 to 480V, 50/60Hz															
	Auxiliary power input for fan Phases, voltage, frequency (*5)	—															
	Voltage, frequency variations	Voltage:+10 to -15% (Voltage unbalance:2% or less (*6)) Frequency:+5 to -5%															
	Rated current [A] (*7)	with DCR	—	—	—	—	—	14.4	21.1	28.8	35.5	42.2	57.0	68.5	83.2	102	138
	without DCR	—	—	—	—	—	23.2	33.0	43.8	52.3	60.6	77.9	94.3	114	140	—	
	Required power supply capacity [kVA] (*8) with DCR	—	—	—	—	—	10	15	20	25	30	40	48	58	71	96	
Braking	Torque [%] (*9)	—			—			70%			15%			7 to 12%			
	Braking transistor	Built-in															
	Min. ohmic value [Ω]	—			—			64	48	32	24	16	16	—			
	Torque [%]	—			—			130%	120%	130%	140%	150%	130%	—			
	Built-in braking resistance	80Ω															
		Braking time[s]	—			—			3.7s	3.4s	—						
		%ED	—			—			2.2	1.4	—						
	DC injection braking	Starting frequency:0.0 to 60.0Hz, Braking time: 0.0 to 30.0s, Braking level:0 to 80%															
EMC filter	EMC standard compliance: Category C3 is only emission and 2nd Env. is immunity. (EN61800-3:2004)																
DC reactor (DCR) (*10)	Optional <span style="float:right">Standard accessory</span>																
Applicable safety standards	UL508C, C22.2No.14, EN50178:1997																
Enclosure (IEC60529)	IP20 (IEC60529) closed type, UL open type (UL 50)   IP00 open type, UL open type																
Cooling method	Fan cooling																
Weight/Mass [kg]	—		—		—		6.8	6.9	6.2	10.5	10.5	11.2	26	27	32	33	

### (75 to 630kW) LD (Low Duty) spec for light load

Item		Specifications														
Type (FRN□□□G1E-4E)		75	90	110	132	160	200	220	280	315	355	400	500	630		
Nominal applied motor [kW] (*1)		90	110	132	160	200	220	280	355	400	450	500	630	710		
Output ratings	Rated capacity [kVA] (*2)	134	160	192	231	287	316	396	495	563	640	731	891	1044		
	Rated voltage [V] (*3)	Three-phase 380 to 480V (with AVR)														
	Rated Current [A]	176	210	253	304	377	415	520	650	740	840	960	1170	1370		
	Overload capability	120% for 1min														
	Rated frequency [Hz]	50, 60Hz														
Input ratings	Main circuit power Phases, voltage, frequency	Three-phase 380 to 440V/50Hz Three-phase 380 to 480V/60Hz														
	Auxiliary control power input Phases, voltage, frequency	Single-phase 380 to 440V, 50/60Hz														
	Auxiliary power input for fan Phases, voltage, frequency (*5)	Single-phase 380 to 440V/50Hz Single-phase 380 to 480V/60Hz														
	Voltage, frequency variations	Voltage:+10 to -15% (Voltage unbalance:2% or less (*6)) Frequency:+5 to -5%														
	Rated current [A] (*7)	with DCR	164	210	238	286	357	390	500	628	705	789	881	1115	1256	
	without DCR	—	—	—	—	—	—	—	—	—	—	—	—	—		
	Required power supply capacity [kVA] (*8) with DCR	114	140	165	199	248	271	347	436	489	547	611	773	871		
Braking	Torque [%] (*9)	7 to 12%														
	Braking transistor	—														
	Min. ohmic value [Ω]	—														
	Torque [%]	—														
	DC injection braking	Starting frequency:0.0 to 60.0Hz, Braking time: 0.0 to 30.0s, Braking level:0 to 80%														
EMC filter	EMC standard compliance: Category C3 is only emission and 2nd Env. is immunity. (EN61800-3:2004)															
DC reactor (DCR) (*10)	Standard accessory															
Applicable safety standards	UL508C, C22.2No.14, EN50178:1997															
Enclosure (IEC60529)	IP00 open type, UL open type															
Cooling method	Fan cooling															
Weight/Mass [kg]	42	62	64	103	103	144	144									

(\*1) Fuji's 4-pole standard motor

(\*2) Rated capacity is calculated by assuming the output rated voltage as 220V for three-phase 200V series and 440V for three-phase 400V series.

(\*3) Output voltage cannot exceed the power supply voltage.

(\*5) The auxiliary power input is used as an AC fan power input when combining the unit such as high power factor PWM converter with power regenerative function. (Generally not used.)

(\*6) Interphase voltage unbalance ratio[%] = (max. voltage [V] - min. voltage [V])/3-phase average voltage [V]×67(See IEC61800-3.) Use the DC reactor (ACR: optional) when used with 2 to 3 % of unbalance ratio.

(\*7) The value is calculated on assumption that the inverter is connected with a power supply capacity of 500kVA (or 10 times the inverter capacity if the inverter capacity exceeds 50kVA) and %X is 5%.

(\*8) Obtained when a DC reactor (DCR) is used.

(\*9) Average braking torque obtained by use of a motor. (Varies with the efficiency of the motor.)

(\*10) The 55kW DC reactor (DCR) is optional with HD spec, and is provided as a standard accessory with LD spec.

# Without EMC filter (Basic type)

## Three-phase 400V series

### (0.4 to 55kW) HD (High Duty) spec for heavy load

Item		Specifications																
Type (FRN□□□G1S-4E)		0.4	0.75	1.5	2.2	4.0	5.5	7.5	11	15	18.5	22	30	37	45	55		
Nominal applied motor [kW] (*1)		0.4	0.75	1.5	2.2	4.0	5.5	7.5	11	15	18.5	22	30	37	45	55		
Output ratings	Rated capacity [kVA] (*2)	1.1	1.9	2.8	4.1	6.8	10	14	18	24	29	34	45	57	69	85		
	Rated voltage [V] (*3)	Three-phase 380 to 480V (with AVR)																
	Rated Current [A]	1.5	2.5	4	5.5	9	13.5	18.5	24.5	32	39	45	60	75	91	112		
	Overload capability	150% for 1min, 200% for 3.0s																
	Rated frequency [Hz]	50, 60Hz																
Input ratings	Main circuit power Phases, voltage, frequency	Three-phase 380 to 480V, 50/60Hz																
	Auxiliary control power input Phases, voltage, frequency	—		Single-phase 380 to 480V, 50/60Hz														
	Auxiliary power input for fan Phases, voltage, frequency (*5)	—																
	Voltage, frequency variations	Voltage:(10 to -15% (Voltage unbalance:2% or less (*6)) Frequency:+5 to -5%																
	Rated current [A] (*7)	with DCR	0.85	1.6	3.0	4.5	7.5	10.6	14.4	21.1	28.8	35.5	42.2	57.0	68.5	83.2	102	
	without DCR	1.7	3.1	5.9	8.2	13.0	17.3	23.2	33	43.8	52.3	60.6	77.9	94.3	114	140		
	Required power supply capacity [kVA] (*8) with DCR	0.6	1.2	2.1	3.2	5.2	7.4	10	15	20	25	30	40	48	58	71		
Braking	Torque [%] (*9)	150%			100%				20%				10 to 15%					
	Braking transistor	Built-in																
	Min. ohmic value [Ω]	200			160		96		64		48		32		24		16	
	Torque [%]	180%			180%		180%		180%		180%		180%		180%		180%	
	Built-in braking resistance	720Ω	470Ω	160Ω				80Ω				—						
		Braking time[s]	5s															
		%ED	5	3	5	3	2	3	2	—								
DC injection braking		Starting frequency:0.0 to 60.0Hz, Braking time: 0.0 to 30.0s, Braking level:0 to 100%																
DC reactor (DCR) (*10)		Optional																
Applicable safety standards		UL508C, C22.2No.14, EN50178:1997																
Enclosure (IEC60529)		IP20 (IEC60529) closed type, UL open type (UL 50)											IP00 open type, UL open type					
Cooling method		Natural cooling					Fan cooling											
Weight/Mass [kg]		1.7	2	2.6	2.7	3	6.5	6.5	5.8	9.5	9.5	10	25	26	31	33		

### (75 to 630kW) HD (High Duty) spec for heavy load

Item		Specifications															
Type (FRN□□□G1S-4E)		75	90	110	132	160	200	220	280	315	355	400	500	630			
Nominal applied motor [kW] (*1)		75	90	110	132	160	200	220	280	315	355	400	500	630			
Output ratings	Rated capacity [kVA] (*2)	114	134	160	192	231	287	316	396	445	495	563	731	891			
	Rated voltage [V] (*3)	Three-phase 380 to 480V (with AVR)															
	Rated Current [A]	150	176	210	253	304	377	415	520	585	650	740	960	1170			
	Overload capability	150% for 1min, 200% for 3.0s															
	Rated frequency [Hz]	50, 60Hz															
Input ratings	Main circuit power Phases, voltage, frequency	Three-phase 380 to 480V, 50Hz Three-phase 380 to 480V, 60Hz															
	Auxiliary control power input Phases, voltage, frequency	Single-phase 380 to 480V, 50/60Hz															
	Auxiliary power input for fan Phases, voltage, frequency (*5)	Single-phase 380 to 440V, 50Hz Single-phase 380 to 480V, 60Hz															
	Voltage, frequency variations	Voltage:+10 to -15% (Voltage unbalance:2% or less (*6)) Frequency:+5 to -5%															
	Rated current [A] (*7)	with DCR	138	164	210	238	286	357	390	500	559	628	705	881	1115		
	without DCR	—	—	—	—	—	—	—	—	—	—	—	—	—			
	Required power supply capacity [kVA] (*8) with DCR	96	114	140	165	199	248	271	347	388	436	489	611	773			
Braking	Torque [%] (*9)	10 to 15%															
	Braking transistor	—															
	Min. ohmic value [Ω]	—															
	Torque [%]	—															
	DC injection braking	Starting frequency:0.0 to 60.0Hz, Braking time: 0.0 to 30.0s, Braking level:0 to 100%															
DC reactor (DCR) (*10)		Standard accessory															
Applicable safety standards		UL508C, C22.2No.14, EN50178:1997															
Enclosure (IEC60529)		IP20(IEC60529) closed type, UL open type (UL 50)															
Cooling method		Fan cooling															
Weight/Mass [kg]		42	62	64	103	103	144	144									

(\*1) Fuji's 4-pole standard motor

(\*2) Rated capacity is calculated by assuming the output rated voltage as 220V for three-phase 200V series and 440V for three-phase 400V series.

(\*3) Output voltage cannot exceed the power supply voltage.

(\*5) The auxiliary power input is used as an AC fan power input when combining the unit such as high power factor PWM converter with power regenerative function. (Generally not used.)

(\*6) Interphase voltage unbalance ratio[%] = (max. voltage [V] - min. voltage [V])/3-phase average voltage [V]×67(See IEC61800-3.) Use the DC reactor (ACR: optional) when used with 2 to 3 % of unbalance ratio.

(\*7) The value is calculated on assumption that the inverter is connected with a power supply capacity of 500kVA (or 10 times the inverter capacity if the inverter capacity exceeds 50kVA) and %X is 5%.

(\*8) Obtained when a DC reactor (DCR) is used.

(\*9) Average braking torque obtained by use of a motor. (Varies with the efficiency of the motor.)

(\*10) The 55kW DC reactor (DCR) is optional with HD spec, and is provided as a standard accessory with LD spec.

# Without EMC filter (Basic type)

## Three-phase 400V series

(90 to 400 kW) MD mode designed for middle duty load applications

Item		Specifications												
Type (FRN□□□G1S-4E)	90	110	132	160	200	220	280	315	355	400				
Nominal applied motor [kW] (*2)	110	132	160	200	220	250	315	355	400	450				
Output ratings	Rated capacity [kVA] (*3)	160	192	231	287	316	356	445	495	563	640			
	Rated voltage [V] (*4)	Three-phase 380 to 480 V (with AVR function)												
	Rated current [A]	210	253	304	377	415	468	585	650	740	840			
	Overload capability	150% for 1 min												
Input ratings	Voltage, frequency	Three-phase 380 to 480 V, 50 Hz Three-phase 380 to 480 V, 60 Hz												
	Voltage, frequency variations	Voltage: +10 to -15% (Interphase voltage unbalance: 2% or less) (*6), Frequency: +5 to -5%												
	Required capacity with DCR [kVA] (*7)	140	165	199	248	271	308	388	436	489	547			
Braking	Torque [%] (*9)	7 to 12%												
	Braking transistor	—												
DC reactor (DCR)	Option (*9)													
Applicable safety standards	UL508C, C22.2 No.14, EN50178:1997													
Enclosure (IEC60529)	IP00, UL open type													
Cooling method	Fan cooling													
Weight/Mass [kg]	62	64	103	103	144	144								

(\*2) Fuji 4-pole standard motor

(\*3) Rated capacity is calculated by assuming the output rated voltage as 220V for 200V series and 440V for 400V series.

(\*4) Output voltage cannot exceed the power supply voltage.

(\*6) Voltage unbalance[%] = (Max. voltage [V] - Min. voltage [V])/Three-phase average voltage [V]×67(See IEC61800-3.) If this value is 2 to 3 %, use an optional AC reactor (ACR).

(\*7) Required when a DC reactor (DCR) is used.

(\*8) Average braking torque obtained by use of a motor. (Varies with the efficiency of the motor.)

(\*9) A DC reactor (DCR) is an option. However, inverters with a capacity of 75 kW or above require a DCR to be connected. Be sure to connect it to those inverters.



## Three-phase 400V series

### (5.5 to 55kW) LD (Low Duty) spec for light load

Item		Specifications																				
Type (FRN□□□G1S-4E)		—	—	—	—	—	5.5	7.5	11	15	18.5	22	30	37	45	55						
Nominal applied motor [kW] (*1)		—	—	—	—	—	7.5	11	15	18.5	22	30	37	45	55	75						
Output ratings	Rated capacity [kVA] (*2)	—	—	—	—	—	12	17	22	28	33	45	57	69	85	114						
	Rated voltage [V] (*3)	Three-phase 380 to 480V (with AVR)																				
	Rated Current [A]	—	—	—	—	—	16.5	23	30.5	37	45	60	75	91	112	150						
	Overload capability	120% for 1min																				
	Rated frequency [Hz]	50, 60Hz																				
Input ratings	Main circuit power Phases, voltage, frequency	Three-phase 380 to 480V, 50/60Hz																				
	Auxiliary control power input Phases, voltage, frequency	Single-phase 380 to 480V, 50/60Hz																				
	Auxiliary power input for fan Phases, voltage, frequency (*5)	—																				
	Voltage, frequency variations	Voltage:+10 to -15% (Voltage unbalance:2% or less (*6)) Frequency:+5 to -5%																				
	Rated current [A] (*7)	with DCR	—	—	—	—	—	14.4	21.1	28.8	35.5	42.2	57.0	68.5	83.2	102	138					
	without DCR	—	—	—	—	—	23.2	33.0	43.8	52.3	60.6	77.9	94.3	114	140	—						
	Required power supply capacity [kVA] (*8) with DCR	—	—	—	—	—	10	15	20	25	30	40	48	58	71	96						
Braking	Torque [%] (*9)	—			70%			15%			7 to 12%											
	Braking transistor	Built-in																				
	Min. ohmic value [Ω]	—			64			48			32			24			16			16		
	Torque [%]	—			130%			120%			130%			140%			150%			130%		
	Built-in braking resistance	80Ω																				
	Braking time[s]	3.7s																				
		3.4s																				
%ED	—																					
DC injection braking	Starting frequency:0.0 to 60.0Hz, Braking time: 0.0 to 30.0s, Braking level:0 to 80%																					
DC reactor (DCR) (*10)	Optional																					
Applicable safety standards	UL508C, C22.2No.14, EN50178:1997																					
Enclosure (IEC60529)	IP20 (IEC60529) closed type, UL open type (UL 50) IP00 open type, UL open type																					
Cooling method	Fan cooling																					
Weight/Mass [kg]	—	—	—	—	—	—	6.5	6.5	5.8	9.5	9.5	10	25	26	31	33						

### (75 to 630kW) LD (Low Duty) spec for light load

Item		Specifications															
Type (FRN□□□G1S-4E)		75	90	110	132	160	200	220	280	315	355	400	500	630			
Nominal applied motor [kW] (*1)		90	110	132	160	200	220	280	355	400	450	500	630	710			
Output ratings	Rated capacity [kVA] (*2)	134	160	192	231	287	316	396	495	563	640	731	891	1044			
	Rated voltage [V] (*3)	Three-phase 380 to 480V (with AVR)															
	Rated Current [A]	176	210	253	304	377	415	520	650	740	840	960	1170	1370			
	Overload capability	120% for 1min															
	Rated frequency [Hz]	50, 60Hz															
Input ratings	Main circuit power Phases, voltage, frequency	Three-phase 380 to 440V/50Hz Three-phase 380 to 480V/60Hz															
	Auxiliary control power input Phases, voltage, frequency	Single-phase 380 to 440V, 50/60Hz															
	Auxiliary power input for fan Phases, voltage, frequency (*5)	Single-phase 380 to 440V/50Hz Single-phase 380 to 480V/60Hz															
	Voltage, frequency variations	Voltage:+10 to -15% (Voltage unbalance:2% or less (*6)) Frequency:+5 to -5%															
	Rated current [A] (*7)	with DCR	164	210	238	286	357	390	500	628	705	789	881	1115	1256		
	without DCR	—	—	—	—	—	—	—	—	—	—	—	—	—			
	Required power supply capacity [kVA] (*8) with DCR	114	140	165	199	248	271	347	436	489	547	611	773	871			
Braking	Torque [%] (*9)	7 to 12%															
	Braking transistor	—															
	Min. ohmic value [Ω]	—															
	Torque [%]	—															
	DC injection braking	Starting frequency:0.0 to 60.0Hz, Braking time: 0.0 to 30.0s, Braking level:0 to 80%															
DC reactor (DCR) (*10)	Standard accessory																
Applicable safety standards	UL508C, C22.2No.14, EN50178:1997																
Enclosure (IEC60529)	IP00 open type, UL open type																
Cooling method	Fan cooling																
Weight/Mass [kg]	42	62	64	103	103	144	144										

(\*1) Fuji's 4-pole standard motor

(\*2) Rated capacity is calculated by assuming the output rated voltage as 220V for three-phase 200V series and 440V for three-phase 400V series.

(\*3) Output voltage cannot exceed the power supply voltage.

(\*5) The auxiliary power input is used as an AC fan power input when combining the unit such as high power factor PWM converter with power regenerative function. (Generally not used.)

(\*6) Interphase voltage unbalance ratio[%] = (max. voltage [V] - min. voltage [V])/3-phase average voltage [V]X67(See IEC61800-3.) Use the DC reactor (ACR: optional) when used with 2 to 3% of unbalance ratio.





(\*7) The value is calculated on assumption that the inverter is connected with a power supply capacity of 500kVA (or 10 times the inverter capacity if the inverter capacity exceeds 50kVA) and %X is 5%.

(\*8) Obtained when a DC reactor (DCR) is used.

(\*9) Average braking torque obtained by use of a motor. (Varies with the efficiency of the motor.)

(\*10) The 55kW DC reactor (DCR) is optional with HD spec, and is provided as a standard accessory with LD spec.

# Common Specifications

Item		Explanation
Setting range	Maximum frequency	25 to 500 Hz (120 Hz for inverters in LD mode) (120 Hz under vector control without speed sensor, 200 Hz under vector control with speed sensor)
	Base frequency	25 to 500 Hz (in conjunction with the maximum frequency)
	Starting frequency	0.1 to 60.0 Hz (0.0 Hz under vector control with/without speed sensor)
	Carrier frequency	<ul style="list-style-type: none"> <li>•0.75 to 16 kHz (HD mode: 0.4 to 55 kW, LD mode: 5.5 to 18.5 kW)</li> <li>•0.75 to 10 kHz (HD mode: 75 kW, LD mode: 22 to 55 kW)</li> <li>•0.75 to 6 kHz (HD mode: --, LD mode: 75 kW)</li> </ul> Note: The carrier frequency may automatically drop depending upon the surrounding temperature or output current to protect the inverter. (The automatic drop function can be disabled.)
Output frequency	Accuracy (Stability)	<ul style="list-style-type: none"> <li>•Analog setting: <math>\pm 0.2\%</math> of maximum frequency (at <math>25 \pm 10^\circ\text{C}</math>)</li> <li>•Keypad setting: <math>\pm 0.01\%</math> of maximum frequency (at <math>-10</math> to <math>+50^\circ\text{C}</math>)</li> </ul>
	Setting resolution	<ul style="list-style-type: none"> <li>•Analog setting: 1/3000 of maximum frequency (1/1500 for V2 input)</li> <li>•Keypad setting: 0.01 Hz (99.99 Hz or less), 0.1 Hz (100.0 to 500.0 Hz)</li> <li>•Link operation setting: Selectable from the following two types               <ul style="list-style-type: none"> <li>- 1/20000 of maximum frequency</li> <li>- 0.01 Hz (fixed)</li> </ul> </li> </ul>
	Speed control range (under vector control without speed sensor)	<ul style="list-style-type: none"> <li>•1 : 200 (Minimum speed: Base speed, 4P, 7.5 to 1500 r/min)</li> <li>•1 : 2 (Constant torque range: Constant output range)</li> </ul>
	Speed control accuracy (under vector control without speed sensor)	<ul style="list-style-type: none"> <li>•Analog setting: <math>\pm 0.5\%</math> of base speed (at <math>25 \pm 10^\circ\text{C}</math>)</li> <li>•Digital setting: <math>\pm 0.5\%</math> of base speed (at <math>-10</math> to <math>+50^\circ\text{C}</math>)</li> </ul>
	Speed control range (under vector control with speed sensor)	<ul style="list-style-type: none"> <li>•1 : 1500 (Minimum speed: Base speed, 4P, 1 to 1500 r/min, 1024 p/r)</li> <li>•1 : 4 (Constant torque range: Constant output range)</li> </ul>
	Speed control accuracy (under vector control with speed sensor)	<ul style="list-style-type: none"> <li>•Analog setting: <math>\pm 0.2\%</math> of maximum frequency (at <math>25 \pm 10^\circ\text{C}</math>)</li> <li>•Digital setting: <math>\pm 0.01\%</math> of maximum frequency (at <math>-10</math> to <math>+50^\circ\text{C}</math>)</li> </ul>
	Control method	<ul style="list-style-type: none"> <li>•V/f control</li> <li>•Dynamic torque vector control</li> <li>•Vector control without speed sensor</li> <li>•Vector control with speed sensor (with an optional PG interface card mounted)</li> </ul>
V/f characteristics	<ul style="list-style-type: none"> <li>•Possible to set output voltage at base frequency and at maximum frequency</li> <li>•AVR control ON/OFF selectable. Non-linear V/f pattern with three arbitrary points.</li> </ul>	
Torque boost	<ul style="list-style-type: none"> <li>•Auto torque boost (for constant torque load)</li> <li>•Manual torque boost: Desired torque boost (0.0 to 20.0%) can be set.</li> <li>•Select application load with function code F37. (Variable torque load or constant torque load)</li> </ul>	
Starting torque	22 kW or below: 200% or over, 30 kW or above: 180% or over Reference frequency: 0.3 Hz with slip compensation and auto torque boost	
Start/stop operation	<ul style="list-style-type: none"> <li>•Keypad (  and  keys), external signals (run forward (run reverse) command etc.), Communications link (RS-485/fieldbus (option))</li> <li>•Remote/local operation</li> </ul>	
Enable input (Safety stop function)	Opening the circuit between terminals [EN] and [PLC] stops the inverter's output transistor (coast-to-stop). (Compliant with EN954-1 Cat.3)	
Frequency command	<ul style="list-style-type: none"> <li>•Keypad:  and  keys</li> <li>•Analog input (Analog input can be set with external voltage/current input):               <ul style="list-style-type: none"> <li>0 to <math>\pm 10</math> VDC/0 to <math>\pm 100\%</math> (terminals [12], [V2])</li> <li>+4 to +20 mA DC/0 to 100% (terminal [C1])</li> </ul> </li> <li>•UP/DOWN operation: Multi-frequency (16 steps), 16-bit parallel</li> <li>•Pulse train input (standard): Pulse input = [X7] terminal, Rotational direction = One of the digital input terminals except [X7]</li> <li>•Link operation: Various buses (option)</li> <li>•Reference frequency switching, Remote/local mode switching, Auxiliary frequency setting, Proportional operation setting, and Inverse operation</li> </ul>	
Acceleration/ deceleration time	0.00 to 6000 s Linear/S-curve/curvilinear, Acceleration/deceleration time settings 1 to 4 switchable	
Stop control	<ul style="list-style-type: none"> <li>•Running continued at the stop frequency, coast-to-stop, or force to stop.</li> <li>•DC braking: Braking starting frequency (up to 60 Hz), time (up to 30.0 s), and operation level (up to 100%)</li> <li>•Zero speed control (under vector control with speed sensor.)</li> </ul>	
Auto-restart after momentary power failure	<ul style="list-style-type: none"> <li>•Trip immediately, trip after recovery from power failure, trip after deceleration to stop</li> <li>•Continue to run, restart at the frequency at which the power failure occurred, restart at the starting frequency, restart after searching for idling motor speed</li> </ul>	
Hardware current limiter	<ul style="list-style-type: none"> <li>•Current limiter operation level (20 to 200%)</li> <li>•Overcurrent limiting by hardware (This can be canceled.)</li> </ul>	
Torque limiter	<ul style="list-style-type: none"> <li>•Torque limit value (<math>\pm 300\%</math>)</li> <li>•Torque limiter 1/2, torque limiter enabled/disabled, analog torque limit value</li> </ul>	

Item		Explanation
Control	Control functions	<ul style="list-style-type: none"> <li>Analog input adjustment (gain/offset/filter time constant), frequency limiter (high and low), bias frequency, jump frequency, jogging operation, pre-excitation, switch to commercial power, commercial power switching sequence, cooling fan ON/OFF control, select motor 2 to 4, protect motor from dew condensation, universal DI, universal DO, universal AO, rotational direction limitation</li> <li>Overload prevention control, auto search, slip compensation, automatic deceleration (anti-regenerative control), droop control, PID process control, PID dancer control, Deceleration characteristics (improving braking capability), auto energy saving function</li> <li>Offline tuning</li> <li>Life early warning, cumulative inverter run time, cumulative motor run time</li> <li>Light alarm, retry, command loss detection</li> </ul>
	Digital input	Run forward command, run reverse command, select multi-frequency (0 to 15 steps), select ACC/DEC time (ACC/DEC time 1 to 4), enable 3-wire operation, coast to a stop, reset alarm, enable external alarm trip, ready for jogging, select frequency command 2/1, select motor 1 to 4, enable DC braking, select torque limiter level, switch to commercial power (50 Hz), switch to commercial power (60 Hz), UP (increase output frequency), DOWN (decrease output frequency), enable data change with keypad, cancel PID control, switch normal/inverse operation, interlock, enable communications link via RS-485 or fieldbus (option), universal DI, enable auto search for idling motor speed at starting, force to stop, pre-excitation, reset PID integral and differential components, hold PID integral component, select local (keypad) operation, protect the motor from dew condensation, enable internal sequence to commercial lines (50 Hz), enable internal sequence to commercial lines (60 Hz), pulse train input, pulse train sign, switch to commercial power operation (motor 1 to 4), select droop control, servo-lock command (under PG vector control), cancel PG alarm (under PG vector control)
	Transistor output	Inverter running, frequency arrival signal 1/3, frequency detected (3 points), undervoltage detected (inverter stopped), torque polarity detected, inverter output limiting, auto-restarting after momentary power failure, motor overload early warning, keypad operation, inverter ready to run, switch motor power between commercial line and inverter output (inverter input/output/commercial power), select the AX terminal function (primary side MC), inverter output limiting with delay, cooling fan in operation, auto-resetting, universal DO, heat sink overheat early warning, service lifetime alarm, reference loss detected, inverter output on, overload prevention control, current detected (3 points), low level current detected, PID alarm, under PID control, PID control stopped due to slow flowrate, low output torque detected, torque detected (2 points), switched to motor 1 to 4, run forward signal, run reverse signal, inverter in remote operation, PTC status detection enabled, brake signal, analog frequency reference loss on the terminal [C1], inverter keeping speed output, speed arrived, PG error detected, maintenance timer, light alarm, alarm relay contact output (for any fault), braking resistor broken, positioning completion signal, Enable circuit failure detected
	Analog output	Terminals [FM1] and [FM2]: Output a selected signal with analog DC voltage (0 to +10 V) or analog DC current (4 to 20 mA) Selectable output signals: Output frequency (before slip compensation, after slip compensation), output current, output voltage, output torque, load factor, input power, PID feedback amount (PV), speed (PG feedback value), DC link bus voltage, universal AO, motor output, calibration, PID command (SV), PID output (MV)
Indication	Running/stopping	Speed monitor (reference frequency (Hz), output frequency, motor speed, load shaft speed, line speed, speed in %) Output current, output voltage, torque calculation value, input power, PID command value, PID feedback amount, PID output, load factor, motor output, torque current, flux command, analog signal input monitor, input watt-hour Life early warning, cumulative inverter run time, cumulative motor run time, input watt-hour, number of startups I/O checking, energy-saving monitor (input power, input power x coefficient (charges for input power))
	Trip mode	Trip history: Saves and displays the last 4 trip factors and their detailed description.
Other features	Communications	RS-485 COM port 1 (for keypad connection), RS-485 COM port 2 (on terminal board), and USB port (on the keypad face)
	Protection against momentary power failure	Upon detection of a momentary power failure lasting more than 15 ms, this function stops the inverter output. If restart after momentary power failure is selected, this function invokes a restart process if power is restored within a predetermined period (allowable momentary power failure time).

Characteristics

Model Variations

Keypad Operations

Inverter Support Loads

Standard Specifications

Common Specifications

Basic Wiring Diagram

Terminal Functions

Function Settings

External Dimensions

Options

Warranty

Variations

# Basic Wiring Diagram

## Wiring of main circuit terminal and grounding terminal

### Basic wiring diagram

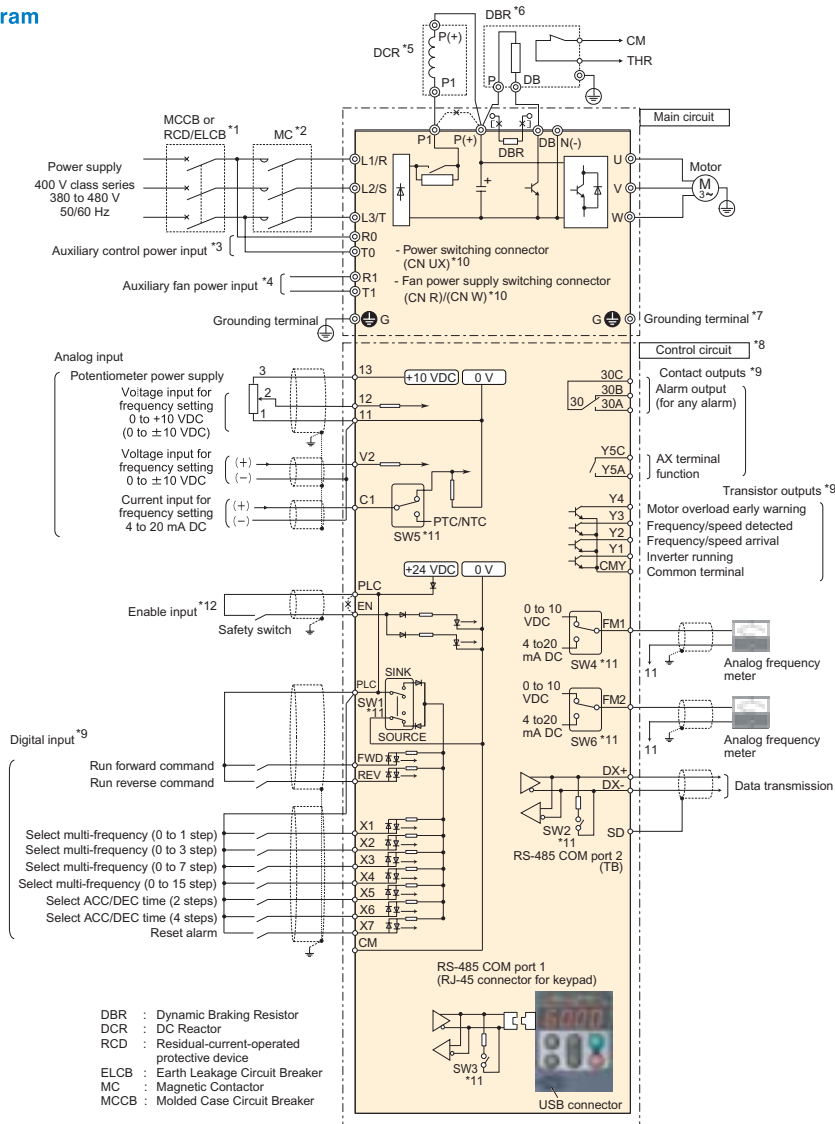

- \*1 Install a recommended molded case circuit breaker (MCCB) or residual-current-operated protective device (RCD)/earth leakage circuit breaker (ELCB) (with overcurrent protection function) in the primary circuit of the inverter to protect wiring. Ensure that the circuit breaker capacity is equivalent to or lower than the recommended capacity.
- \*2 Install a magnetic contactor (MC) for each inverter to separate the inverter from the power supply, apart from the MCCB or RCD/ELCB, when necessary. Connect a surge absorber in parallel when installing a coil such as the MC or solenoid near the inverter.
- \*3 To retain an alarm output signal **ALM** issued on inverter's programmable output terminals or to keep the keypad alive even if the main power has shut down, connect these terminals to the power supply lines. Without power supply to these terminals, the inverter can run.
- \*4 Normally no need to be connected. Use these terminals when the inverter is equipped with a high power-factor, regenerative PWM converter (RHC series).
- \*5 When connecting an optional DC reactor (DCR), remove the jumper bar from the terminals P1 and P(+). Inverters with a capacity of 55 kW in LD mode and inverters with 75 kW or above require a DCR to be connected. Be sure to connect it to those inverters. Use a DCR when the capacity of the power supply transformer exceeds 500 kVA and is 10 times or more the inverter rated capacity, or when there are thyristor-driven loads in the same power supply line.
- \*6 Inverters with a capacity of 7.5 kW or below have a built-in braking resistor (DBR) between the terminals P(+) and DB. When connecting an external braking resistor (DBR), be sure to disconnect the built-in one.
- \*7 A grounding terminal for a motor. Use this terminal if needed.
- \*8 For control signal wires, use twisted or shielded-twisted wires. When using shielded-twisted wires, connect the shield of them to the common terminals of the control circuit. To prevent malfunction due to noise, keep the control circuit wiring away from the main circuit wiring as far as possible (recommended: 10 cm or more). Never install them in the same wire duct. When crossing the control circuit wiring with the main circuit wiring, set them at right angles.
- \*9 The connection diagram shows factory default functions assigned to digital input terminals [X1] to [X7], [FWD] and [REV], transistor output terminals [Y1] to [Y4], and relay contact output terminals [Y5A/C] and [30A/B/C].
- \*10 Switching connectors in the main circuits.
- \*11 Slide switches on the control printed circuit board (control PCB). Use these switches to customize the inverter operations.
- \*12 When using the Enable input function, be sure to remove the jumper wire from terminals [EN] and [PLC]. For opening and closing the hardware circuit between terminals [EN] and [PLC], use safety components such as safety relays and safety switches that comply with EN954-1, Category 3 or higher. Be sure to use shielded wires exclusive to terminals [EN] and [PLC]. (Do not put them together with any other control signal wire in the same shielded core.) Ground the shielding layer.  
 "When not using the Enable input function, keep the terminals between [EN] and [PLC] short-circuited with the jumper wire (factory default)."

# Terminal Functions

## Terminal Functions

Classification	Symbol	Name	Functions	Remarks
Main circuit terminals	L1/R, L2/S, L3/T	Main circuit power inputs	Connect the three-phase input power lines.	
	R0, T0	Auxiliary power input for the control circuit	Connect AC power lines.	
	R1, T1	Auxiliary power input for the fans	Normally, no need to use these terminals. Use these terminals for an auxiliary power input of the fans in a power system using a power regenerative PWM converter.	(200 V 37 kW or above) (400 V 75 kW or above)
	U,V,W	Inverter outputs	Connect a three-phase motor.	
	P(+),P1	DC reactor connection	Connect a DC reactor (DCR).	
	P(+),N(-)	DC link bus	Terminal for DC bus link system.	
	P(+),DB	Braking resistor	Connect an external braking resistor (option).	(22kW or below)
⊕G	Grounding for inverter	Grounding terminals for the inverter.		
Analog Input	[13]	Power supply for the potentiometer	Power supply (+10 VDC) for frequency command potentiometer (Variable resistor: 1 to 5kW) The potentiometer of 1/2 W rating or more should be connected. (10 VDC, 10 mADC max.)	
	[12]	Analog setting voltage input	• External input voltage to be used as a frequency command. 0 to +10 VDC/ 0% to 100% (0 to +5 VDC/ 0% to 100%) 0 to ±10 VDC/ 0% to ±100% (0 to ±5 VDC/ 0% to ±100%)	Input impedance: 22kΩ Maximum input ±15 VDC
		(Inverse operation)	• +10 to 0 VDC/ 0 to 100%	
		(PID control)	Used as PID command value or PID feedback signal.	Gain: 200%
		(Auxiliary frequency setting)	• Used as additional auxiliary setting to various frequency settings.	Offset: ±5%
		(Gain setting)	• Used as gain for the frequency command. 0% to 100% for 0 to 10 V	Setting filter: 5 s
		(Torque limit value)	• Analog torque limit value	
	(Torque command)	• Analog torque command value *6*7	*8	
	(Analog input monitor)	• Enables peripheral analog signals to be displayed on the keypad. (Display coefficient valid)		
	[C1]	Analog setting current input	• External input voltage to be used as a frequency command. 4 to 20 mADC/ 0% to 100%	Input impedance: 250Ω Maximum input 30 mADC
		(Inverse operation)	• 20 to 4 mADC/ 0% to 100%	
		(PID control)	Used as PID command value or PID feedback signal.	Gain: 200%
		(PTC/NTC thermistor connection)	• Connect a PTC/NTC thermistor for motor protection. (Switchable)	Offset: ±5%
		(Auxiliary frequency setting)	• Used as additional auxiliary setting to various frequency settings.	Setting filter: 5 s
		(Gain setting)	• Used as gain for the frequency command. 0% to 100% for 4 to 20 mA	
	(Torque limit value)	• Analog torque limit value		
	(Torque command)	• Analog torque command value *6*7	*8	
	(Analog input monitor)	• Enables peripheral analog signals to be displayed on the keypad. (Display coefficient valid)		
	[V2]	Analog setting voltage input	• External input voltage to be used as a frequency command. 0 to +10 VDC/ 0 to 100% (0 to +5 VDC/ 0 to 100%) 0 to ±10 VDC/ 0 to ±100% (0 to ±5 VDC/ 0 to ±100%)	Input impedance: 22kΩ Maximum input ±15 VDC
		(Inverse operation)	• +10 to 0 VDC/ 0 to 100%	
		(PID control)	Used as PID command value or PID feedback signal.	Gain: 200%
(Auxiliary frequency setting)		• Used as additional auxiliary setting to various frequency settings.	Offset: ±5%	
(Gain setting)		• Used as gain for the frequency command. 0% to 100% for 0 to 10 V	Setting filter: 5 ss	
(Torque limit value)		• Analog torque limit value		
(Torque command)	• Analog torque command value *6*7	*8		
(Analog input monitor)	• Enables peripheral analog signals to be displayed on the keypad. (Display coefficient valid)			
[11] (2 terminals)	Analog common	Common terminals for frequency command signals (12, 13, C1, V2, FM1,FM2).	These terminals are electrically isolated from terminals [CM]s and [CMY]s.	
Digital Input	[X1]	Digital input 1	• The following functions can be assigned to terminals [X1] to [X7], [FWD], and [REV]. <Common functions> • SINK/SOURCE is changeable by using the internal slide switch. • These function codes may also switch the logic system between normal and negative to define how the inverter logic interprets either ON or OFF status of each terminal.	Operation current at ON Source current: 2.5 to 5 mA Source current: 11 to 16 mA (terminal [X7])  Voltage level: 2 V
	[X2]	Digital input 2		
	[X3]	Digital input 3		
	[X4]	Digital input 4		
	[X5]	Digital input 5		
	[X6]	Digital input 6		
	[X7]	Digital input 7		
	[FWD]	Run forward commands	Terminal [X7] can receive a pulse rate input. (Using the SY disables [X7].)	Operation current at OFF Allowable leakage current: 0.5 mA or less Voltage: 22 to 27 V
	[REV]	Run reverse commands		
	[EN]	Enable Input	• This terminal stops output transistor (making coast-to-stop) when the terminal EN-PLC is turned off. This terminal is dedicated for source input.	Source current at Turn-on : 5-10mA
	[CM]	Digital input common	Common terminals for digital input signals.	This terminal is electrically isolated from terminals [CM]s and [11]s.
	[PLC] (2 terminals)	PLC signal power	Connect to PLC output signal power supply. This terminal also serves as 24 V power supply.	+24 V (22 to 27 V), Max. 100 mA
	(FWD)	Run forward	Turning the (FWD) ON runs the motor in the forward direction; turning it OFF decelerates it to a stop.	These terminal commands can be assigned only to terminals [FWD] and [REV]. The negative logic system never applies to those terminals.
	(REV)	Run reverse	Turning the (REV) ON runs the motor in the reverse direction; turning it OFF decelerates it to a stop.	Same as above.
(SS1)	Select multi-frequency	The combination of the ON/OFF states of digital input signals (SS1), (SS2), (SS4) and (SS8) provides 16 different frequency choices.		
(SS2)				
(SS4)				
(SS8)				
(RT1)	Select ACC/DEC time (2 steps)	The combination of the ON/OFF states of (RT1) and (RT2) provides four choices of acceleration/deceleration settings.		
(RT2)	Select ACC/DEC time (4 steps)			
(HLD)	Enable 3-wire operation	Used as a self-hold signal for 3-wire inverter operation. Turning the (HLD) ON self-holds the (FWD) or (REV) command; turning it OFF releases the self-holding.		

# Terminal Functions

## Terminal Functions

Classification	Symbol	Name	Functions	Remarks
Digital Input	(BX)	Coast to a stop	Turning the (BX) ON immediately shuts down the inverter output so that the motor coasts to a stop without issuing any alarms.	
	(RST)	Reset alarm	Turning the (RST) ON clears the alarm state.	Signal of 0.1 s or more
	(THR)	Enable external alarm trip	Turning the (THR) OFF immediately shuts down the inverter output so that the motor coasts to a stop, issuing OH2 if (ALM) is enabled.	
	(JOG)	Ready for jogging	Turning the (JOG) ON readies the inverter for jogging. Turning the (FWD) or (REV) ON starts jogging in the rotation direction specified by the jogging frequency.	
	(Hz2/Hz1)	Select frequency command 2/1	Turning the (Hz2/Hz1) ON selects Frequency command 2. (If the PID control is enabled, this terminal command switches the PID command.)	
	(M2)	Select motor 2	The combination of the ON/OFF states of (M2), (M3) and (M4) provides four choices of Motors 1 to 4. (Setting all of (M2), (M3) and (M4) OFF selects Motor 1.)	
	(M3)	Select motor 3		
	(M4)	Select motor 4		
	(DCBRK)	Enable DC braking	Turning the (DCBRK) ON activates DC braking.	
	(TL2/TL1)	Select torque limiter level	The (TL2/TL1) switches between torque limiters 1 and 2.	
	(SW50)	Switch to commercial power (50 Hz)	Turning the (SW50) OFF switches to commercial power, 50 Hz.*1~*3	
	(SW60)	Switch to commercial power (60 Hz)	Turning the (SW60) OFF switches to commercial power, 60 Hz.*1~*3	
	(UP)	UP (Increase output frequency)	While the (UP) is ON, the output frequency increases.	
	(DOWN)	DOWN (Decrease output frequency)	While the (UP) is ON, the output frequency decreases.	
	(WE-KP)	Enable data change with keypad	Only when the (WE-KP) is ON, function code data can be changed with the keypad.	
	(Hz/PID)	Cancel PID control	Turning the (Hz/PID) ON disables the PID control so that the inverter runs the motor with a reference frequency specified by any of the multi-frequency, keypad, analog input, etc.	
	(IVS)	Switch normal/inverse operation	The (INV) switches the output frequency control between normal (proportional to the input value) and inverse in PID process control and manual frequency command. Turning the (INV) ON selects the inverse operation.	
	(IL)	Interlock	In a configuration where a magnetic contactor (MC) is inserted between the inverter and motor, connecting the auxiliary contact to this terminal enables the input of the (IL) when a power failure occurs, activating the momentary power failure detection fu	
	(LE)	Enable communications link via RS-485 or field bus	Turning the (LE) ON gives priority to commands received via the RS-485 communications link or the field bus option.	
	(U-DI)	Universal DI	Using the (U-DI) enables the inverter to monitor arbitrary digital input signals sent from the peripheral equipment, telling the signal status to the host controller.	
	(STM)	Enable auto search for idling motor speed at starting	The (STM) enables auto search for idling motor speed at the start of operation.	
	(STOP)	Force to stop	Turning the (STOP) OFF causes the motor to decelerate to a stop forcedly in accordance with the specified deceleration time.	
	(PID-RST)	Reset PID integral and differential components	Turning the (PID-RST) ON resets PID integral and differential components.	
	(PID-HLD)	Hold PID integral component	Turning this terminal command ON holds the integral components of the PID processor.	
	(EXITE)	Pre-excitation	When this (EXITE) signal comes ON, preliminary excitation starts.*6*7	
	(LOC)	Select local (keypad) operation	Turning the (LOC) ON gives priority to run/frequency commands entered from the keypad.	
	(DWP)	Protect motor from dew condensation	Turning the (DWP) ON supplies a DC current to the motor that is on halt, in order to generate heat, preventing dew condensation.	
	(ISW50)	Enable integrated sequence to switch to commercial power (50 Hz)	Turning the (ISW50) OFF switches inverter operation to commercial-power operation in accordance with the inverter internal switching sequence (for 50 Hz).	
	(ISW60)	Enable integrated sequence to switch to commercial power (60 Hz)	Turning the (ISW50) OFF switches inverter operation to commercial-power operation in accordance with the inverter internal switching sequence (for 60 Hz).	
	(OLS)	Enable/disable overload stop function	Turning (OLS) enables the overload stop function.*1~*5	*8
	(PIN)	Pulse train input	Frequency command by pulse rate input.	Available only on terminal [X7] (E07)
	(SIGN)	Pulse train sign	Rotational direction command for pulse rate input. OFF: Forward, ON: Reverse	Available only on terminal [X7] (E07)
	(CRUN-M1)	Count the run time of commercial power-driven motor 1	Turning the (CRUN-M1) ON accumulates the run time of motor 1 in commercial-power operation. (Independent of run/stop and motor selected)	
	(CRUN-M2)	Count the run time of commercial power-driven motor 2	Turning the (CRUN-M2) ON accumulates the run time of motor 2 in commercial-power operation. (Independent of run/stop and motor selected)	
(CRUN-M3)	Count the run time of commercial power-driven motor 3	Turning the (CRUN-M3) ON accumulates the run time of motor 3 in commercial-power operation. (Independent of run/stop and motor selected)		
(CRUN-M4)	Count the run time of commercial power-driven motor 4	Turning the (CRUN-M4) ON accumulates the run time of motor 4 in commercial-power operation. (Independent of run/stop and motor selected)		
(DROOP)	Select droop control	Turning the(DROOP) ON enables the droop control.		
(PG-CCL)	Cancel PG alarm	Turning the(PG-CCL) ON cancels PG alarm.*4*5*7		
(LOCK)	Servo-lock command	Turning the(LOCK) ON enables the servo-lock control.*7		
(NONE)	No function	No function assigned. Can be used as a temporary input of the customized logic interface.		

Classification	Symbol	Name	Functions	Remarks
Transistor output	(PLC)	Transistor output power	Transistor output load power. (24 VDC, 100 mA DC max.) (Note: Shared by the digital input PLC terminal.)	Short-circuit terminals [CM] and [CMY].
	[Y1]	Transistor output 1	Out of the following signals, the selected one will be issued. • These function codes may also switch the logic system between normal and negative to define how the inverter logic interprets either ON or OFF status of each terminal.	Maximum voltage 27 VDC Maximum current 50 mADC
	[Y2]	Transistor output 2	Applicable to SINK and SOURCE. (No switching is required.)	Leakage current 0.1 mA or less ON voltage: Max. 2V (50 mA)
	[Y3]	Transistor output 3		
	[Y4]	Transistor output 4		
	[CMY]	Transistor output common	Common terminal for transistor output signal terminals.	This terminal is electrically isolated from terminals [CM]s and [1]s.
	(RUN)	Inverter running	This signal is ON when the inverter is running with the starting frequency or higher.	
	(RUN2)	Inverter output on	This signal is ON when the inverter is running with the starting frequency or higher or when the DC braking is activated.	
	(DNZS)	Speed valid	This signal is turned ON when the speed command/actual speed exceeds the stop frequency; it is turned OFF when it is below the stop frequency. (Speed command and actual speed selectable.)	
	(FRUN)	Running forward	ON-signal is generated at forward rotation.	
	(RRUN)	Running reverse	ON-signal is generated at reverse rotation	
	(FAR)	Frequency (speed) arrival signal	ON-signal is generated when frequency / speed reaches at set-value.	
	(FAR3)	Frequency (speed) arrival signal 3	ON-signal is generated when frequency / speed reaches at set-value. When the run command is OFF, the frequency command is interpreted as zero and frequency arrival is judged under the premise.	
	(FDT)	Frequency (speed) detected	This output signal comes ON when the output frequency exceeds the frequency detection level, and it goes OFF when the output frequency drops below the "Frequency detection level - Hysteresis width."	
	(FDT2)	Frequency (speed) detected 2		
	(FDT3)	Frequency (speed) detected 3		
	(LU)	Undervoltage detected (Inverter stopped)	This signal is ON when the undervoltage protection function is activated so that the motor is in an abnormal stop state.	
	(B/D)	Torque polarity detected	This signal comes ON when the inverter is driving the motor; it comes OFF when the inverter is braking the motor or on halt.	
	(IOL)	Inverter output limiting	This signal comes ON when the inverter is activating the current limiter, torque limiter, or anti-regenerative control (automatic deceleration).	
	(IOL2)	Inverter output limiting with delay	This signal comes ON when the inverter has been activated the current limiter, torque limiter, or anti-regenerative control (automatic deceleration) for at least 20 ms.	
	(IPF)	Auto-restarting after momentary power failure	This signal is kept ON during the period from when the inverter shuts down its output due to a momentary power failure until the restart is completed.	
	(OL)	Motor overload early warning	This signal comes ON when the value calculated by the electronic thermal overload protection exceeds the predetermined detection level. (applicable to Motor 1 only)	
	(KP)	Keypad operation enabled	This signal is ON when the inverter is in keypad operation.	
	(RDY)	Inverter ready to run	This signal comes ON when the inverter is ready to run.	
	(SW88)	Switch motor drive source between commercial power and inverter output (For MC on commercial line)	This controls the magnetic contactor located at the commercial power line side, for switching the motor drive source from the commercial power line to inverter output.	
	(SW52-2)	Switch motor drive source between commercial power and inverter output (For secondary side)	This controls the magnetic contactor located at the inverter output side (secondary side), for switching the motor drive source from the commercial power line to inverter output.	
	(SW52-1)	Switch motor drive source between commercial power and inverter output (For primary side)	This controls the magnetic contactor located at the inverter input side (primary side), for switching the motor drive source from the commercial power line to inverter output.	
	(SWM1)	Motor 1 selected	This signal comes ON when motor 1 is selected.	
	(SWM2)	Motor 2 selected	This signal comes ON when motor 2 is selected.	
	(SWM3)	Motor 3 selected	This signal comes ON when motor 3 is selected.	
	(SWM4)	Motor 4 selected	This signal comes ON when motor 4 is selected.	
	(AX)	Select AX terminal function (For MC on primary side)	This signal controls the magnetic contactor located at the inverter input side (primary side).	
	(FAN)	Cooling fan in operation	This signal tells the ON/OFF state of the cooling fan.	
	(TRY)	Auto-resetting	This output signal comes ON when auto-resetting is in progress.	
	(U-DO)	Universal DO	This signal commands a peripheral apparatus according to signal sent from the host controller.	
	(ID)	Current detected	This signal comes ON when the output current of the inverter has exceeded the detection level for the time longer than the specified timer period.	
	(ID2)	Current detected 2		
	(ID3)	Current detected 3		
	(TD1)	Torque detected 1	This signal comes ON when the output torque of the inverter has exceeded the detection level for the time longer than the specified timer period.	
	(TD2)	Torque detected 2		
	(OH)	Heat sink overheat early warning	This outputs a heat sink overheat early warning before an overheat trip actually happens. It is also used to detect an internal air circulation fan failure. (Applicable to inverters with 45kW or above for 200V class series or 75 kW or above for 400V class series)	
	(LIFE)	Lifetime alarm	This outputs a service lifetime alarm according to the internal lifetime criteria. It is also used to detect an internal air circulation fan failure. (Applicable to inverters with 45kW or above for 200V class series or 75 kW or above for 400V class series)	
(PID-ALM)	PID alarm	This outputs an absolute-value alarm and deviation alarm when the PID control is enabled.		
(PID-CTL)	Under PID control	This signal comes ON when the PID control is enabled.		
(PID-STP)	Motor stopped due to slow flowrate under PID control	This signal is ON when the inverter is in a stopped state by the slow flowrate stopping function under the PID control. (The inverter is stopped even if a run command is entered.)		
(REF OFF)	Reference loss detected	This signal comes ON when an analog frequency command is missed due to wire breaks.		
(IDL)	Low current detected	This signal comes ON when the current has been below the preset current detection level for the time longer than the specified timer period.		
(U-TL)	Low output torque detected	This signal comes ON when the torque value has been below the preset detection level for the time longer than the specified timer period.		

Characteristics  
Model Variations  
Keypad Operations  
Inverter Support Loader  
Standard Specifications  
Common Specifications  
Basic Wiring Diagram  
Terminal Functions  
Function Settings  
External Dimensions  
Options  
Warranty  
Variations

# Terminal Functions

## Terminal Functions

Classification	Symbol	Name	Functions	Remarks
Transistor output	(OLP)	Overload prevention control	This output signal comes ON when the overload prevention control is activated.	
	(RMT)	In remote operation	This signal comes ON when the inverter is in the remote mode.	
	(BRKS)	Brake signal	Signal for Brake Control. Turn ON when the brake is released.	
	(MNT)	Maintenance timer	Alarm signal is generated when time passes or start-up exceeds over the preset value	
	(THM)	Motor overheat detected by thermistor	This signal comes ON when the motor overheat is detected with the PTC/NTC thermistor.	
	(C1OFF)	Terminal [C1] wire break	When Input current to C1 terminal become less than 2mA, this is interpreted as wire brake and then ON-signal is generated.	
	(DSAG)	Speed agreement	This output signal comes ON when the difference between the detected speed and the commanded speed (frequency) has been within the specified range for the time specified by the agreement timer.	
	(PG-ERR)	PG error detected	Speed Deflection is greater than the certain value, ON-signal is generated.	
	(DECF)	Enable circuit failure detected	This signal comes ON when the circuit detecting the status of [EN] terminal is defective. (at single failure)	
	(ENOFF)	Enable input OFF	On-signal is generated when Enable Input is turned off.	
	(DBAL)	Braking transistor broken	This signal comes ON when the DBTr defective is detected.	
	(PSET)	Positioning completion signal	This signal comes ON when the inverter has been servo-locked so that the motor is held within the positioning completion range.	
	(L-ALM)	Light alarm	When Alarm or warning, which is set as "light failure", is generated, inverter indicates "Light failure" on the display and generates this light failure signal.	
(ALM)	Alarm output (for any alarm)	This is an alarm relay output as a transistor output.		
Relay output	[Y5A], [Y5C]	General purpose relay output	<ul style="list-style-type: none"> <li>As a general-purpose relay output, the same functions as Y1 to Y4 can be assigned.</li> <li>The logic value is switchable between "[Y5A] and [Y5C] are excited" and "non-excited."</li> </ul>	Contact rating: 250 VAC, 0.3 A cosφ=0.3
	[30A], [30B], [30C]	Alarm relay output (for any error)	<ul style="list-style-type: none"> <li>This outputs a non-voltage contact signal (1c) when the inverter is stopped with the protective function.</li> <li>As a general-purpose relay output, the same functions as Y1 to Y4 can be assigned.</li> <li>The logic value is switchable between "[Y5A] and [Y5C] are excited" and "non-excited."</li> </ul>	48 VDC, 0.5A
Analog output	[FM1] [FM2]	Analog monitor 1 Analog monitor 2	<p>The output can be either analog DC voltage (0 to 10 V) or analog DC current (4 to 20 mA). Any one of the following items can be output with the selected analog form.</p> <ul style="list-style-type: none"> <li>Output frequency (before slip compensation, after slip compensation)</li> <li>Output current</li> <li>Output voltage</li> <li>Output torque</li> <li>Load factor</li> <li>Input power</li> <li>PID feedback amount</li> <li>DC link bus voltage</li> <li>Universal AO</li> <li>Motor output</li> <li>Analog output test</li> <li>PID command</li> <li>PID output</li> <li>Speed detection (PG feedback value)</li> </ul> <p>*When the terminal is outputting 0 to 10 VDC, it is capable of driving up to two meters with 10kΩ impedance.</p> <p>*When the terminal is outputting current, it is capable of connecting a maximum of 500Ω to the meter.</p> <p>Adjustable gain range: 0% to 300%</p>	
	[11]	Analog common		
Communication	RJ-45 connector for the keypad	RS-485 communications port 1	<p>Out of the following protocols, the desired one can be selected.</p> <ul style="list-style-type: none"> <li>Modbus RTU</li> <li>Fuji general-purpose inverter protocol</li> <li>FRENIC Loader protocol (SX)</li> </ul>	With power supply to the keypad
	[DX+]/[DX-]/[SD]	RS-485 communications port 2(Terminalson control PCB)	<ul style="list-style-type: none"> <li>Modbus RTU</li> <li>Fuji general-purpose inverter protocol</li> </ul>	
	USBconnec-tor	USB port (On the keypad)	A USB port connector (Mini-B) that connects an inverter to a personal computer. FRENIC Loader.	Mounted on Remote Keypad (option)

\*1 Effective function in V/f control

\*2 Effective function in dynamic torque vector control

\*3 Effective function when the slip compensation is made active under V/f control

\*4 Effective function under the V/f control with speed sensor (PG option is necessary.)

\*5 Effective function in dynamic torque vector control with speed sensor. (PG option is necessary.)

\*6 Effective function in vector control without speed sensor

\*7 Effective function in vector control with speed sensor (PG option is necessary.)

\*8 Function not incorporated in the inverters of initial version



## Terminal Arrangement

### Main circuit terminals

Power supply voltage	Nominal applied motor (kW)	Inverter type	HD/LD mode	Refer to:
Three-phase 400V	0.4	FRN0.4G1■-4E	HD	Figure A
	0.75	FRN0.75G1■-4E		
	1.5	FRN1.5G1■-4E		
	2.2	FRN2.2G1■-4E		
	3.7 (4.0)*	FRN4.0G1■-4E		
	5.5	FRN5.5G1■-4E	HD	Figure C
	7.5	FRN7.5G1■-4E	LD	
	11	FRN11G1■-4E	HD	
	15	FRN15G1■-4E	LD	
	18.5	FRN18.5G1■-4E	HD	
	22	FRN22G1■-4E	LD	Figure D
	30	FRN30G1■-4E	HD	
	37	FRN37G1■-4E	LD	
	45	FRN45G1■-4E	HD	Figure E
	55	FRN55G1■-4E	LD	
	75	FRN75G1■-4E	HD	
	90	FRN75G1■-4E	LD	Figure F

\* 4.0 kW for the EU. The inverter type is FRN4.0G1■-4E.  
 Note: A box (■) in the above table replaces S or E depending on the enclosure.

Terminal R0, T0: Screw size M3.5, Tightening torque 1.2 N·m (common to all inverter types)  
 Terminal R1, T1: Screw size M3.5, Tightening torque 1.2 N·m (for 200 V class series with 37 kW or above and for 400 V class series with 75 kW or above)

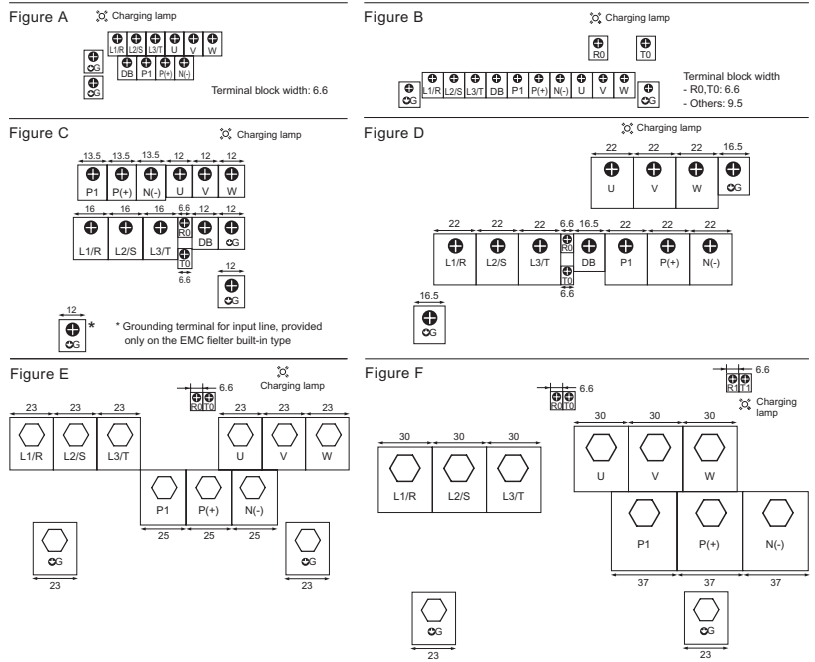

### Control circuit terminals (common to all the inverter models)

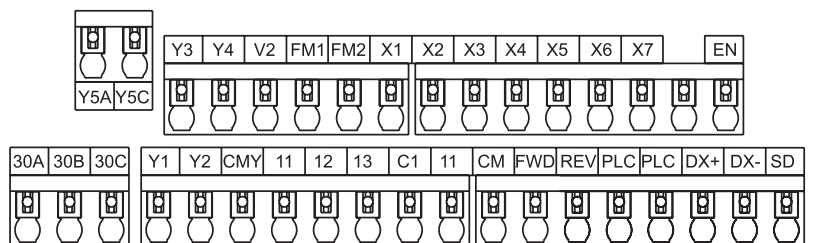

# Function Settings

## Function Settings

### F codes: Fundamental Functions

Code	Name	Data setting range	Change when running	Data copying	Default setting	Drive control		
						V/f	W/O PG	W/PG
F00	Data Protection	0 : Disable both data protection and digital reference protection 1 : Enable data protection and disable digital reference protection 2 : Disable data protection and enable digital reference protection 3 : Enable both data protection and digital reference protection	○	○	0	○	○	○
F01	Frequency Command 1	0 : ⏻ / ⏹ keys on keypad 1 : Voltage input to terminal [12] (-10 to +10 VDC) 2 : Current input to terminal [C1] (4 to 20 mA DC) 3 : Sum of voltage and current inputs to terminals [12] and [C1] 5 : Voltage input to terminal [V2] (0 to ±10 VDC) 7 : Terminal command UP/DOWN control 8 : ⏻ / ⏹ keys on keypad (balanceless-bumpless switching available) 11 : Digital input interface card (option) 12 : PG interface card	None	○	0	○	○	○
F02	Operation Method	0 : RUN/STOP keys on keypad (Motor rotational direction specified by terminal command FWD/REV) 1 : Terminal command FWD or REV 2 : RUN/STOP keys on keypad (forward) 3 : RUN/STOP keys on keypad (reverse)	None	○	2	○	○	○
F03	Maximum Frequency 1	25.0 to 500.0 Hz	None	○	*1	○	○	○
F04	Base Frequency 1	25.0 to 500.0 Hz	None	○	50.0	○	○	○
F05	Rated Voltage at Base Frequency 1	0 : Output a voltage in proportion to input voltage 80 to 240 V : Output an AVR-controlled voltage (for 200 V class series) 160 to 500 V : Output an AVR-controlled voltage (for 400 V class series)	None	△2	*1	○	○	○
F06	Maximum Output Voltage 1	80 to 240 V : Output an AVR-controlled voltage (for 200 V class series) 160 to 500 V : Output an AVR-controlled voltage (for 400 V class series)	None	△2	*1	○	None	None
F07	Acceleration Time 1	0.00 to 6000 s	○	○	*2	○	○	○
F08	Deceleration Time 1	Note: Entering 0.00 cancels the acceleration time, requiring external soft-start.	○	○	*2	○	○	○
F09	Torque Boost 1	0.0% to 20.0% (percentage with respect to "Rated Voltage at Base Frequency 1")	○	○	*3	○	None	None
F10	Electronic Thermal Overload Protection for Motor 1 (Select motor characteristics)	1 : For a general-purpose motor with shaft-driven cooling fan 2 : For an inverter-driven motor, non-ventilated motor, or motor with separately powered cooling fan	○	○	1	○	○	○
F11	(Overload detection level)	0.00: Disable 1% to 135% of the rated current (allowable continuous drive current) of the motor	○	△1△2	*4	○	○	○
F12	(Thermal time constant)	0.5 to 75.0 min	○	○	*5	○	○	○
F14	Restart Mode after Momentary Power Failure (Mode selection)	0 : Trip immediately 1 : Trip after a recovery from power failure 2 : Trip after decelerate-to-stop 3 : Continue to run, for heavy inertia or general loads 4 : Restart at the frequency at which the power failure occurred, for general loads 5 : Restart at the starting frequency	○	○	1	○	○	○
F15	Frequency Limiter (High)	0.0 to 500.0 Hz	○	○	70.0	○	○	○
F16	(Low)	0.0 to 500.0 Hz	○	○	0.0	○	○	○
F18	Bias (Frequency command 1)	-100.00% to 100.00%	⊗	○	0.00	○	○	○
F20	DC Braking 1 (Braking starting frequency)	0.0 to 60.0 Hz	○	○	0.0	○	○	○
F21	(Braking level)	0% to 100% (HD mode), 0% to 80% (LD mode)	○	○	0	○	○	○
F22	(Braking time)	0.00 (Disable); 0.01 to 30.00 s	○	○	0.00	○	○	○
F23	Starting Frequency 1 (Holding time)	0.0 to 60.0 Hz	○	○	0.5	○	○	○
F24	Stop Frequency	0.00 to 10.00 s	○	○	0.00	○	○	○
F25	Motor Sound (Carrier frequency)	0.75 to 16 kHz (HD-mode inverters with 55 kW or below and LD-mode ones with 18.5 kW or below) 0.75 to 10 kHz (HD-mode inverters with 75 to 630 kW and LD-mode ones with 22 to 55 kW) 0.75 to 6 kHz (LD-mode inverters with 75 to 630 kW)	○	○	2 (Asia) 15 (EU)	○	○	○
F27	(Tone)	0 : Level 0 (Inactive) 1 : Level 1 2 : Level 2 3 : Level 3	○	○	0	○	None	None
F29	Analog Output [FM1] (Mode selection)	0 : Output in voltage (0 to 10 VDC) 1 : Output in current (4 to 20 mA DC)	○	○	0	○	○	○
F30	(Voltage adjustment)	0% to 300%	⊗	○	100	○	○	○
F31	(Function)	Select a function to be monitored from the followings. 0 : Output frequency 1 (before slip compensation) 1 : Output frequency 2 (after slip compensation) 2 : Output current 3 : Output voltage 4 : Output torque 5 : Load factor 6 : Input power 7 : PID feedback amount 8 : PG feedback value 9 : DC link bus voltage 10 : Universal AO 13 : Motor output 14 : Calibration (+) 15 : PID command (SV) 16 : PID output (MV)	○	○	0	○	○	○
F32	Analog Output [FM2] (Mode selection)	0: Output in voltage (0 to 10 VDC) 1: Output in current (4 to 20 mA DC)	○	○	0	○	○	○
F34	(Voltage adjustment)	0% to 300%	⊗	○	100	○	○	○
F35	(Function)	Select a function to be monitored from the followings. 0 : Output frequency 1 (before slip compensation) 1 : Output frequency 2 (after slip compensation) 2 : Output current 3 : Output voltage 4 : Output torque	○	○	0	○	○	○

### F codes: Fundamental Functions

Code	Name	Data setting range	Change when running	Data copying	Default setting	Drive control		
						V/f	W/O PG	W/PG
F35	Analog Output [FM2] (Function)	5 : Load factor 6 : Input power 7 : PID feedback amount 8 : PG feedback value 9 : DC link bus voltage 10 : Universal AO 13 : Motor output 14 : Calibration 15 : PID command (SV) 16 : PID output (MV)	○	○	0	○	○	○
F37	Load Selection/ Auto Torque Boost/ Auto Energy Saving Operation 1	0 : Variable torque load 1 : Constant torque load 2 : Auto torque boost 3 : Auto energy saving(Variable torque load during ACC/DEC) 4 : Auto energy saving(Constant torque load during ACC/DEC) 5 : Auto energy saving(Auto torque boost during ACC/DEC)	None	○	1	○	None	○
F38	Stop Frequency(Detection mode)	0 : Detected speed 1 : Commanded speed	None	○	0	None	None	○
F39	(Holding Time)	0.00 to 10.00 s	○	○	0.00	○	○	○
F40	Torque Limiter 1-1	-300% to 300%; 999 (Disable)	○	○	999	○	○	○
F41	1-2	-300% to 300%; 999 (Disable)	○	○	999	○	○	○
F42	Drive Control Selection 1	0 : V/f control with slip compensation inactive 1 : Dynamic torque vector control 2 : V/f control with slip compensation active 5 : Vector control without speed sensor 6 : Vector control with speed sensor	None	○	0	○	○	○
F43	Current Limiter (Mode selection)	0 : Disable (No current limiter works.) 1 : Enable at constant speed (Disable during ACC/DEC) 2 : Enable during ACC/constant speed operation	○	○	2	○	None	None
F44	(Level)	20% to 200% (The data is interpreted as the rated output current of the inverter for 100%.)	○	○	160	○	None	None
F50	Electronic Thermal Overload Protection for Braking Resistor (Discharging capability)	0 (Braking resistor built-in type), 1 to 9000 kW, OFF (Disable)	○	△1△2	6	○	○	○
F51	(Allowable average loss)	0.001 to 99.99 kW	○	△1△2	0.001	○	○	○
F52	(Resistance)	0.01 to 999Ω	○	△1△2	0.01	○	○	○
F80	Switching between HD and LD drive modes	0 : HD (High Duty) mode 1 : LD (Low Duty) mode	None	○	0	○	○	○

### E codes: Extension Terminal Functions

Code	Name	Data setting range	Change when running	Data copying	Default setting	Drive control			
						V/f	W/O PG	W/PG	
E01	Terminal [X1] Function	Selecting function code data assigns the corresponding function to terminals [X1] to [X7] as listed below.	None	○	0				
E02	Terminal [X2] Function		None	○	1				
E03	Terminal [X3] Function	0 (1000) : Select multi-frequency (0 to 1 steps) (SS1)	None	○	2	○	○	○	
E04	Terminal [X4] Function	1 (1001) : Select multi-frequency (0 to 3 steps) (SS2)	None	○	3	○	○	○	
E05	Terminal [X5] Function	2 (1002) : Select multi-frequency (0 to 7 steps) (SS4)	None	○	4	○	○	○	
E06	Terminal [X6] Function	3 (1003) : Select multi-frequency (0 to 15 steps) (SS8)	None	○	5	○	○	○	
E07	Terminal [X7] Function	4 (1004) : Select ACC/DEC time (2 steps) (RT1) 5 (1005) : Select ACC/DEC time (4 steps) (RT2) 6 (1006) : Enable 3-wire operation (HLD) 7 (1007) : Coast to a stop (BX) 8 (1008) : Reset alarm (RST) 9 (1009) : Enable external alarm trip (9 = Active OFF, 1009 = Active ON) (THR) 10 (1010) : Ready for jogging (JOG) 11 (1011) : Select frequency command 2/1 (Hz2/Hz1) 12 (1012) : Select motor 2 (M2) 13 : Enable DC braking (DCBRK) 14 (1014) : Select torque limiter level 2/1 (TL2/TL1) 15 : Switch to commercial power (50 Hz) (SW50) 16 : Switch to commercial power (60 Hz) (SW60) 17 (1017) : UP (Increase output frequency) (UP) 18 (1018) : DOWN (Decrease output frequency) (DOWN) 19 (1019) : Enable data change with keypad (WE-KP) 20 (1020) : Cancel PID control (Hz/PID) 21 (1021) : Switch normal/inverse operation (IVS) 22 (1022) : Interlock (IL) 24 (1024) : Enable communications link via RS-485 or fieldbus (option) (LE) 25 (1025) : Universal DI (U-DI) 26 (1026) : Enable auto search for idling motor speed at starting (STM) 30 (1030) : Force to stop (30 = Active OFF, 1030 = Active ON) (STOP) 32 (1032) : Pre-excitation (EXITE) 33 (1033) : Reset PID integral and differential components (PID-RST) 34 (1034) : Hold PID integral component (PID-HLD) 35 (1035) : Select local (keypad) operation (LOC) 36 (1036) : Select motor 3 (M3)	None	○	8	○	○	○	○
						○	None	None	
						○	None	None	
						○	○	○	
						○	○	○	
						○	○	○	
						○	○	○	
						○	○	○	
						○	○	○	
						○	○	○	
						○	○	○	
						○	○	○	
						○	○	○	
						○	○	○	
						○	○	○	
						○	○	○	

The shaded function codes ( ) are applicable to the quick setup.

- \*1 The factory default differs depending upon the shipping destination.
  - \*2 6.00 s for inverters with a capacity of 22 kW or below; 20.00 s for those with 30 kW or above.
  - \*3 The factory default differs depending upon the inverter's capacity.
  - \*4 The motor rated current is automatically set.
  - \*5 5.0 min for inverters with a capacity of 22 kW or below; 10.0 min for those with 30 kW or above.
  - \*6 0 for inverters with a capacity of 7.5 kW or below; OFF for those with 0.11 kW or above.
- <Data change, reflection and strage>

None: Not available ○ : After changing data with using ⬅️ ➡️ keys, execute and save data by pressing ⏹️ key,  
Ⓤ After changing and executing data with using ⬅️ ➡️ keys, save the data by pressing ⏹️ key.

#### Data copy

○	Data copy is enabled.
△1	Data copy is not enabled if the inverter capacities vary.
△2	Data copy is not enabled if the voltage classes vary.
None	Data copy is not enabled.

# Function Settings

## Function Settings

### E codes: Extension Terminal Functions

Code	Name	Data setting range	Change when running	Data copying	Default setting	Drive control			
						V/f	W/OPG	W/PG	
<b>E07</b>	Terminal [X7] Function	37 (1037) : Select motor 4 (M4) 39 : Protect motor from dew condensation (DWP) 40 : Enable integrated sequence to switch to commercial power (50 Hz) (ISW50) 41 : Enable integrated sequence to switch to commercial power (60 Hz) (ISW60) 47 (1047) : Servo-lock command (LOCK) 48 : Pulse train input (available only on terminal [X7] (E07)) (PIN) 49 (1049) : Pulse train sign (available on terminals except [X7] (E01 to E06)) (SIGN) 72 (1072) : Count the run time of commercial power-driven motor 1 (CRUN-M1) 73 (1073) : Count the run time of commercial power-driven motor 2 (CRUN-M2) 74 (1074) : Count the run time of commercial power-driven motor 3 (CRUN-M3) 75 (1075) : Count the run time of commercial power-driven motor 4 (CRUN-M4) 76 (1076) : Select droop control (DROOP) 77 (1077) : Cancel PG alarm (PG-CCL) Setting the value of 1000s in parentheses ( ) shown above assigns a negative logic input to a terminal.	None	○	8	○	○	○	
<b>E10</b>	Acceleration Time 2	0.00 to 6000 s	○	○	*2	○	○	○	
<b>E11</b>	Deceleration Time 2	Note: Entering 0.00 cancels the acceleration time, requiring external soft-start and -stop.	○	○	*2	○	○	○	
<b>E12</b>	Acceleration Time 3		○	○	*2	○	○	○	
<b>E13</b>	Deceleration Time 3		○	○	*2	○	○	○	
<b>E14</b>	Acceleration Time 4		○	○	*2	○	○	○	
<b>E15</b>	Deceleration Time 4		○	○	*2	○	○	○	
<b>E16</b>	Torque Limiter 2-1	-300% to 300%; 999 (Disable)	○	○	999	○	○	○	
<b>E17</b>	Torque Limiter 2-2	-300% to 300%; 999 (Disable)	○	○	999	○	○	○	
<b>E20</b>	Terminal [Y1] Function	Selecting function code data assigns the corresponding function to terminals [Y1] to [Y5A/C] and [30A/B/C] as listed below.	None	○	0				
<b>E21</b>	Terminal [Y2] Function		None	○	1				
<b>E22</b>	Terminal [Y3] Function	0 (1000) : Inverter running (RUN)	None	○	2	○	○	○	
<b>E23</b>	Terminal [Y4] Function	1 (1001) : Frequency (speed) arrival signal (FAR)	None	○	7	○	○	○	
<b>E24</b>	Terminal [Y5A/C] Function	2 (1002) : Frequency (speed) detected (FDT)	None	○	15	○	○	○	
<b>E27</b>	Terminal [30A/B/C] Function (Relay output)	3 (1003) : Undervoltage detected (Inverter stopped) (LU) 4 (1004) : Torque polarity detected (B/D) 5 (1005) : Inverter output limiting (IOL) 6 (1006) : Auto-restarting after momentary power failure (IPF) 7 (1007) : Motor overload early warning (OL) 8 (1008) : Keypad operation enabled (KP) 10 (1010) : Inverter ready to run (RDY) 11 : Switch motor drive source between commercial power and inverter output (For MC on commercial line) (SW88) 12 : Switch motor drive source between commercial power and inverter output (For secondary side) (SW52-2) 13 : Switch motor drive source between commercial power and inverter output (For primary side) (SW52-1) 15 (1015) : Select AX terminal function (For MC on primary side) (AX) 22 (1022) : Inverter output limiting with delay (IOL2) 25 (1025) : Cooling fan in operation (FAN) 26 (1026) : Auto-resetting (TRY) 27 (1027) : Universal DO (U-DO) 28 (1028) : Heat sink overheat early warning (OH) 30 (1030) : Lifetime alarm (LIFE) 31 (1031) : Frequency (speed) detected 2 (FDT2) 33 (1033) : Reference loss detected (REF OFF) 35 (1035) : Inverter output on (RUN2) 36 (1036) : Overload prevention control (OLP) 37 (1037) : Current detected (ID) 38 (1038) : Current detected 2 (ID2) 39 (1039) : Current detected 3 (ID3) 41 (1041) : Low current detected (IDL) 42 (1042) : PID alarm (PID-ALM) 43 (1043) : Under PID control (PID-CTL) 44 (1044) : Motor stopped due to slow flowrate under PID control (PID-STP) 45 (1045) : Low output torque detected (U-TL) 46 (1046) : Torque detected 1 (TD1) 47 (1047) : Torque detected 2 (TD2) 48 (1048) : Motor 1 selected (SWM1) 49 (1049) : Motor 2 selected (SWM2) 50 (1050) : Motor 3 selected (SWM3) 51 (1051) : Motor 4 selected (SWM4) 52 (1052) : Running forward (FRUN) 53 (1053) : Running reverse (RRUN) 54 (1054) : In remote operation (RMT) 56 (1056) : Motor overheat detected by thermistor (THM) 57 (1057) : Brake signal (BRKS) 58 (1058) : Frequency (speed) detected 3 (FDT3) 59 (1059) : Terminal [C1] wire break (C1OFF) 70 (1070) : Speed valid (DNZS) 71 (1071) : Speed agreement (DSAG) 72 (1072) : Frequency (speed) arrival signal 3 (FAR3) 76 (1076) : PG error detected (PG-ERR) 82 (1082) : Positioning completion signal (PSET) 84 (1084) : Maintenance timer (MNT) 98 (1098) : Light alarm (L-ALM) 99 (1099) : Alarm output (for any alarm) (ALM) 101 (1101) : Enable circuit failure detected (DECFF) 102 (1102) : Enable input OFF (EN OFF)	None	○	99	○	○	○	○
						○	None	None	
						○	None	None	
						○	None	None	
						○	None	None	
						○	None	None	
						○	None	None	
						○	None	None	
						○	None	None	
						○	None	None	
						○	None	None	
						○	None	None	
						○	None	None	
						○	None	None	
						○	None	None	
						○	None	None	
						○	None	None	
						○	None	None	
						○	None	None	
						○	None	None	
						○	None	None	
						○	None	None	
						○	None	None	
						○	None	None	
						○	None	None	
						○	None	None	
						○	None	None	
						○	None	None	
						○	None	None	
						○	None	None	
						○	None	None	
						○	None	None	
						○	None	None	
						○	None	None	
						○	None	None	
						○	None	None	
						○	None	None	
						○	None	None	

## E codes: Extension Terminal Functions

Code	Name	Data setting range	Change when running	Data copying	Default setting	Drive control		
						V/f	W/OPG	W/PG
E27	Terminal [30A/B/C] Function (Relay output)	105 (1105): Braking transistor broken (DBAL) Setting the value of 1000s in parentheses ( ) shown above assigns a negative logic input to a terminal.	None	○	99	○	○	○
E30	Frequency Arrival (Detection width)	0.0 to 10.0 Hz	○	○	2.5	○	○	○
E31	Frequency Detection 1 (Level)	0.0 to 500.0 Hz	○	○	*1	○	○	○
E32	(Hysteresis width)	0.0 to 500.0 Hz	○	○	1.0	○	○	○
E34	Overload Early Warning (Level)	0.00 (Disable); Current value of 1% to 200% of the inverter rated current	○	△1△2	*4	○	○	○
E35	Current Detection (Timer)	0.01 to 600.00s	○	○	10.00	○	○	○
E36	Frequency Detection 2 (Level)	0.0 to 500.0Hz	○	○	*1	○	○	○
E37	Current Detection 2/ (Level)	0.00 (Disable); Current value of 1% to 200% of the inverter rated current	○	△1△2	*4	○	○	○
E38	Low Current Detection (Timer)	0.01 to 600.00 s	○	○	10.00	○	○	○
E40	PID Display Coefficient A	-999 to 0.00 to 9990	○	○	100	○	○	○
E41	PID Display Coefficient B	-999 to 0.00 to 9990	○	○	0.00	○	○	○
E42	LED Display Filter	0.0 to 5.0 s	○	○	0.5	○	○	○
E43	LED Monitor (Item selection)	0 : Speed monitor (select by E48) 3 : Output current 4 : Output voltage 8 : Calculated torque 9 : Input power 10 : PID command 12 : PID feedback amount 14 : PID output 15 : Load factor 16 : Motor output 17 : Analog input 23 : Torque current (%) 24 : Magnetic flux command (%) 25 : Input watt-hour	○	○	0	○	○	○
E44	(Display when stopped)	0 : Specified value 1 : Output value	○	○	0	○	○	○
E45	LCD Monitor (Item selection)	0 : Running status, rotational direction and operation guide 1 : Bar charts for output frequency, current and calculated torque	○	○	0	○	○	○
E46	(Language selection)	Multi-function keypad (option) Type: TP-G1-J1 0 : Japanese 1 : English 2 : German 3 : French 4 : Spanish 5 : Italian	○	○	1	○	○	○
E47	(Contrast control)	0 (Low) to 10 (High)	○	○	5	○	○	○
E48	LED Monitor (Speed monitor item)	0 : Output frequency (Before slip compensation) 1 : Output frequency (After slip compensation) 2 : Reference frequency 3 : Motor speed in r/min 4 : Load shaft speed in r/min 5 : Line speed in m/min 7 : Display speed in %	○	○	0	○	○	○
E50	Coefficient for Speed Indication	0.01 to 200.00	○	○	30.00	○	○	○
E51	Display Coefficient for Input Watt-hour Data	0.000 (Cancel/reset), 0.001 to 9999	○	○	0.010	○	○	○
E52	Keypad (Menu display mode)	0 : Function code data editing mode (Menu #0, #1, and #7) 1 : Function code data check mode (Menu #2 and #7) 2 : Full-menu mode	○	○	0	○	○	○
E54	Frequency Detection 3 (Level)	0.0 to 500.0 Hz	○	○	*1	○	○	○
E55	Current Detection 3 (Level)	0.00 (Disable); Current value of 1% to 200% of the inverter rated current	○	1△2△	*4	○	○	○
E56	(Timer)	0.01 to 600.00 s	○	○	10.00	○	○	○
E61	Terminal [12] Extended Function	0 : None	None	○	0	○	○	○
E62	Terminal [C1] Extended Function	1 : Auxiliary frequency command 1	None	○	0	○	○	○
E63	Terminal [V2] Extended Function	2 : Auxiliary frequency command 2 3 : PID command 1 5 : PID feedback amount 6 : Ratio setting 7 : Analog torque limit value A 8 : Analog torque limit value B 20 : Analog input monitor	None	○	0	○	○	○
E64	Saving of Digital Reference Frequency	0 : Automatic saving (when main power is turned OFF) 1 : Saving by pressing  key	○	○	1	○	○	○
E65	Reference Loss Detection (Continuous running frequency)	0 : Decelerate to stop, 20% to 120%, 999: Disable	○	○	999	○	○	○
E78	Torque Detection 1 (Level)	0% to 300%	○	○	100	○	○	○
E79	(Timer)	0.01 to 600.00 s	○	○	10.00	○	○	○
E80	Torque Detection 2/ (Level)	0% to 300%	○	○	20	○	○	○
E81	Low Torque Detection (Timer)	0.01 to 600.00 s	○	○	20.00	○	○	○
E98	Terminal [FWD] Function	Selecting function code data assigns the corresponding function to terminals [FWD] and [REV] as listed below.	None	○	98	○	○	○
E99	Terminal [REV] Function	0 (1000): Select multi-frequency (0 to 1 steps) (SS1) 1 (1001): Select multi-frequency (0 to 3 steps) (SS2) 2 (1002): Select multi-frequency (0 to 7 steps) (SS4) 3 (1003): Select multi-frequency (0 to 15 steps) (SS8) 4 (1004): Select ACC/DEC time (2 steps) (RT1)	None	○	99	○	○	○

The shaded function codes ( ) are applicable to the quick setup.

\*1 The factory default differs depending upon the shipping destination.

\*2 6.00 s for inverters with a capacity of 22 kW or below; 20.00 s for those with 30 kW or above.

\*4 The motor rated current is automatically set.

<Data change, reflection and strage>

None: Not available ○: After changing data with using , execute and save data by pressing key,

: After changing and executing data with using , save the data by pressing key.

### Data copy

○	Data copy is enabled.
△1	Data copy is not enabled if the inverter capacities vary.
△2	Data copy is not enabled if the voltage classes vary.
None	Data copy is not enabled.

# Function Settings

## Function Settings

### E codes: Extension Terminal Functions

Code	Name	Data setting range	Change when running	Data copying	Default setting	Drive control		
						V/f	W/O PG	W/PG
<del>E98</del>	Terminal [FWD] Function	5 (1005): Select ACC/DEC time (4 steps) (RT2)	None	<input type="radio"/>	98	<input type="radio"/>	<input type="radio"/>	<input type="radio"/>
<del>E99</del>	Terminal [REV] Function	6 (1006): Enable 3-wire operation (HLD)	None	<input type="radio"/>	99	<input type="radio"/>	<input type="radio"/>	<input type="radio"/>
		7 (1007): Coast to a stop (BX)				<input type="radio"/>	<input type="radio"/>	<input type="radio"/>
		8 (1008): Reset alarm (RST)				<input type="radio"/>	<input type="radio"/>	<input type="radio"/>
		9 (1009): Enable external alarm trip(9 = Active OFF, 1009 = Active ON) (THR)				<input type="radio"/>	<input type="radio"/>	<input type="radio"/>
		10 (1010): Ready for jogging (JOG)				<input type="radio"/>	<input type="radio"/>	<input type="radio"/>
		11 (1011): Select frequency command 2/1 (Hz2/Hz1)				<input type="radio"/>	<input type="radio"/>	<input type="radio"/>
		12 (1012): Select motor 2 (M2)				<input type="radio"/>	<input type="radio"/>	<input type="radio"/>
		13 : Enable DC braking (DCBRK)				<input type="radio"/>	<input type="radio"/>	<input type="radio"/>
		14 (1014): Select torque limiter level 2/1 (TL2/TL1)				<input type="radio"/>	<input type="radio"/>	<input type="radio"/>
		15 : Switch to commercial power (50 Hz) (SW50)				<input type="radio"/>	None	None
		16 : Switch to commercial power (60 Hz) (SW60)				<input type="radio"/>	None	None
		17 (1017): UP (Increase output frequency) (UP)				<input type="radio"/>	<input type="radio"/>	<input type="radio"/>
		18 (1018): DOWN (Decrease output frequency) (DOWN)				<input type="radio"/>	<input type="radio"/>	<input type="radio"/>
		19 (1019): Enable data change with keypad (WE-KP)				<input type="radio"/>	<input type="radio"/>	<input type="radio"/>
		20 (1020): Cancel PID control (Hz/PID)				<input type="radio"/>	<input type="radio"/>	<input type="radio"/>
		21 (1021): Switch normal/inverse operation (IVS)				<input type="radio"/>	<input type="radio"/>	<input type="radio"/>
		22 (1022): Interlock (IL)				<input type="radio"/>	<input type="radio"/>	<input type="radio"/>
		24 (1024): Enable communications link via RS-485 or fieldbus (LE)				<input type="radio"/>	<input type="radio"/>	<input type="radio"/>
		25 (1025): Universal DI (U-DI)				<input type="radio"/>	<input type="radio"/>	<input type="radio"/>
		26 (1026): Enable auto search for idling motor speed at starting (STM)				<input type="radio"/>	None	None
		30 (1030): Force to stop (30 = Active OFF, 1030 = Active ON) (STOP)				<input type="radio"/>	<input type="radio"/>	<input type="radio"/>
		32 (1032): Pre-excitation (EXITE)				None	<input type="radio"/>	<input type="radio"/>
		33 (1033): Reset PID integral and differential components (PID-RST)				<input type="radio"/>	<input type="radio"/>	<input type="radio"/>
		34 (1034): Hold PID integral component (PID-HLD)				<input type="radio"/>	<input type="radio"/>	<input type="radio"/>
		35 (1035): Select local (keypad) operation (LOC)				<input type="radio"/>	<input type="radio"/>	<input type="radio"/>
		36 (1036): Select motor 3 (M3)				<input type="radio"/>	<input type="radio"/>	<input type="radio"/>
		37 (1037): Select motor 4 (M4)				<input type="radio"/>	<input type="radio"/>	<input type="radio"/>
		39 : Protect motor from dew condensation (DWP)				<input type="radio"/>	<input type="radio"/>	<input type="radio"/>
		40 : Enable integrated sequence to switch to commercial power (50 Hz) (ISW50)				<input type="radio"/>	None	None
		41 : Enable integrated sequence to switch to commercial power (60 Hz) (ISW60)				<input type="radio"/>	None	None
		47 (1047): Servo-lock command (LOCK)				None	None	<input type="radio"/>
		49 (1049): Pulse train sign (SIGN)				<input type="radio"/>	<input type="radio"/>	<input type="radio"/>
		72 (1072): Count the run time of commercial power-driven motor 1 (CRUN-M1)				<input type="radio"/>	None	None
		73 (1073): Count the run time of commercial power-driven motor 2 (CRUN-M2)				<input type="radio"/>	None	None
		74 (1074): Count the run time of commercial power-driven motor 3 (CRUN-M3)				<input type="radio"/>	None	None
		75 (1075): Count the run time of commercial power-driven motor 4 (CRUN-M4)				<input type="radio"/>	None	None
		76 (1076): Select droop control (DROOP)				<input type="radio"/>	<input type="radio"/>	<input type="radio"/>
		77 (1077): Cancel PG alarm (PG-CCL)				None	None	<input type="radio"/>
		98 : Run forward (FWD)				<input type="radio"/>	<input type="radio"/>	<input type="radio"/>
		99 : Run reverse (REV)				<input type="radio"/>	<input type="radio"/>	<input type="radio"/>

Setting the value of 1000s in parentheses ( ) shown above assigns a negative logic input to a terminal.

### C codes: Control Functions of Frequency

Code	Name	Data setting range	Change when running	Data copying	Default setting	Drive control		
						V/f	W/O PG	W/PG
<del>C01</del>	Jump Frequency 1	0.0 to 500.0 Hz	<input type="radio"/>	<input type="radio"/>	0.0	<input type="radio"/>	<input type="radio"/>	<input type="radio"/>
<del>C02</del>	2		<input type="radio"/>	<input type="radio"/>	0.0	<input type="radio"/>	<input type="radio"/>	<input type="radio"/>
<del>C03</del>	3		<input type="radio"/>	<input type="radio"/>	0.0	<input type="radio"/>	<input type="radio"/>	<input type="radio"/>
<del>C04</del>	(Hysteresis width)	0.0 to 30.0 Hz	<input type="radio"/>	<input type="radio"/>	3.0	<input type="radio"/>	<input type="radio"/>	<input type="radio"/>
<del>C05</del>	Multi-frequency 1	0.00 to 500.00 Hz	<input type="radio"/>	<input type="radio"/>	0.00	<input type="radio"/>	<input type="radio"/>	<input type="radio"/>
<del>C06</del>	2		<input type="radio"/>	<input type="radio"/>	0.00	<input type="radio"/>	<input type="radio"/>	<input type="radio"/>
<del>C07</del>	3		<input type="radio"/>	<input type="radio"/>	0.00	<input type="radio"/>	<input type="radio"/>	<input type="radio"/>
<del>C08</del>	4		<input type="radio"/>	<input type="radio"/>	0.00	<input type="radio"/>	<input type="radio"/>	<input type="radio"/>
<del>C09</del>	5		<input type="radio"/>	<input type="radio"/>	0.00	<input type="radio"/>	<input type="radio"/>	<input type="radio"/>
<del>C10</del>	6		<input type="radio"/>	<input type="radio"/>	0.00	<input type="radio"/>	<input type="radio"/>	<input type="radio"/>
<del>C11</del>	7		<input type="radio"/>	<input type="radio"/>	0.00	<input type="radio"/>	<input type="radio"/>	<input type="radio"/>
<del>C12</del>	8		<input type="radio"/>	<input type="radio"/>	0.00	<input type="radio"/>	<input type="radio"/>	<input type="radio"/>
<del>C13</del>	9		<input type="radio"/>	<input type="radio"/>	0.00	<input type="radio"/>	<input type="radio"/>	<input type="radio"/>
<del>C14</del>	10		<input type="radio"/>	<input type="radio"/>	0.00	<input type="radio"/>	<input type="radio"/>	<input type="radio"/>
<del>C15</del>	11		<input type="radio"/>	<input type="radio"/>	0.00	<input type="radio"/>	<input type="radio"/>	<input type="radio"/>
<del>C16</del>	12		<input type="radio"/>	<input type="radio"/>	0.00	<input type="radio"/>	<input type="radio"/>	<input type="radio"/>
<del>C17</del>	13		<input type="radio"/>	<input type="radio"/>	0.00	<input type="radio"/>	<input type="radio"/>	<input type="radio"/>
<del>C18</del>	14		<input type="radio"/>	<input type="radio"/>	0.00	<input type="radio"/>	<input type="radio"/>	<input type="radio"/>
<del>C19</del>	15		<input type="radio"/>	<input type="radio"/>	0.00	<input type="radio"/>	<input type="radio"/>	<input type="radio"/>
<del>C20</del>	Jogging Frequency	0.00 to 500.00 Hz	<input type="radio"/>	<input type="radio"/>	0.00	<input type="radio"/>	<input type="radio"/>	<input type="radio"/>
<del>C30</del>	Frequency Command 2	0 : Enable <input type="radio"/> / <input type="radio"/> keys on the keypad 1 : Analog voltage input to terminal [12] (-10 to +10 VDC) 2 : Analog current input to terminal [C1] (4 to 20 mA DC) 3 : Analog sum of voltage and current inputs to terminals [12] and [C1] 5 : Analog voltage input to terminal [V2] (0 to 10 VDC) 7 : Terminal command UP/DOWN control 8 : Enable <input type="radio"/> / <input type="radio"/> keys on the keypad (balanceless-bumpless switching available) 11 : Digital input interface card (option) 12 : PG interface card	None	<input type="radio"/>	2	<input type="radio"/>	<input type="radio"/>	<input type="radio"/>
<del>C31</del>	Analog Input Adjustment for [12](Offset)	-5.0% to 5.0%	<input checked="" type="radio"/>	<input type="radio"/>	0.0	<input type="radio"/>	<input type="radio"/>	<input type="radio"/>
<del>C32</del>	(Gain)	0.00% to 200.00%	<input checked="" type="radio"/>	<input type="radio"/>	100.0	<input type="radio"/>	<input type="radio"/>	<input type="radio"/>
<del>C33</del>	(Filter time constant)	0.00 to 5.00 s	<input type="radio"/>	<input checked="" type="radio"/>	0.05	<input type="radio"/>	<input type="radio"/>	<input type="radio"/>
<del>C34</del>	(Gain base point)	0.00% to 100.00%	<input checked="" type="radio"/>	<input type="radio"/>	100.00	<input type="radio"/>	<input type="radio"/>	<input type="radio"/>
<del>C35</del>	(Polarity)	0 : Bipolar 1 : Unipolar	None	<input type="radio"/>	1	<input type="radio"/>	<input type="radio"/>	<input type="radio"/>

## C codes: Control Functions of Frequency

Code	Name	Data setting range	Change when running	Data copying	Default setting	Drive control		
						V/f	W/O PG	W/PG
<b>C36</b>	Analog Input Adjustment for [C1] (Offset)	-5.0% to 5.0%	☉	○	0.0	○	○	○
<b>C37</b>	(Gain)	0.00% to 200.00%	☉	○	100.00	○	○	○
<b>C38</b>	(Filter time constant)	0.00 to 5.00s	○	○	0.05	○	○	○
<b>C39</b>	(Gain base point)	0.00% to 100.00%	☉	○	100.00	○	○	○
<b>C41</b>	Analog Input Adjustment for [V2] (Offset)	-5.0% to 5.0%	☉	○	0.0	○	○	○
<b>C42</b>	(Gain)	0.00% to 200.00%	☉	○	100.00	○	○	○
<b>C43</b>	(Filter time constant)	0.00 to 5.00 s	○	○	0.05	○	○	○
<b>C44</b>	(Gain base point)	0.00% to 100.00%	☉	○	100.00	○	○	○
<b>C45</b>	(Polarity)	0 : Bipolar 1 : Unipolar	None	○	1	○	○	○
<b>C50</b>	Bias(Frequency command 1)(Bias base point)	0.00% to 100.00%	☉	○	0.00	○	○	○
<b>C51</b>	Bias(PID command 1)(Bias value)	-100.00% to 100.00%	☉	○	0.00	○	○	○
<b>C52</b>	(Bias base point)	0.00% to 100.00%	☉	○	0.00	○	○	○
<b>C53</b>	Selection of Normal/Inverse Operation (Frequency command 1)	0 : Normal operation 1 : Inverse operation	○	○	0	○	○	○

## P codes: Motor 1 Parameters

Code	Name	Data setting range	Change when running	Data copying	Default setting	Drive control		
						V/f	W/O PG	W/PG
<b>P01</b>	Motor 1 (No. of poles)	2 to 22 poles	None	△1△2	4	○	○	○
<b>P02</b>	(Rated capacity)	0.01 to 1000 kW (when P99 = 0, 2, 3 or 4) 0.01 to 1000 HP (when P99 = 1)	None	△1△2	*7	○	○	○
<b>P03</b>	(Rated current)	0.00 to 2000 A	None	△1△2	*7	○	○	○
<b>P04</b>	(Auto-tuning)	0 : Disable 1 : Tune while the motor stops. (%R1, %X and rated slip frequency) 2 : Tune while the motor is rotating under V/f control(%R1, %X, rated slip frequency, no-load current, magnetic saturation factors 1 to 5, and magnetic saturation extension factors "a" to "c") 3 : Tune while the motor is rotating under vector control(%R1, %X, rated slip frequency, no-load current, magnetic saturation factors 1 to 5, and magnetic saturation extension factors "a" to "c." Available when the vector control is enabled.)	None	None	0	○	○	○
<b>P05</b>	(No-load current)	0.00 to 2000 A	None	△1△2	*7	○	○	○
<b>P07</b>	(%R1)	0.00% to 50.00%	○	△1△2	*7	○	○	○
<b>P08</b>	(%X)	0.00% to 50.00%	○	△1△2	*7	○	○	○
<b>P09</b>	(Slip compensation gain for driving)	0.0% to 200.0%	☉	○	100.0	○	○	○
<b>P10</b>	(Slip compensation response time)	0.01 to 10.00 s	○	△1△2	0.12	○	None	None
<b>P11</b>	(Slip compensation gain for braking)	0.0% to 200.0%	☉	○	100.0	○	○	○
<b>P12</b>	(Rated slip frequency)	0.00 to 15.00 Hz	None	△1△2	*7	○	○	○
<b>P13</b>	(Iron loss factor 1)	0.00% to 20.00%	○	△1△2	*7	○	○	○
<b>P14</b>	(Iron loss factor 2)	0.00% to 20.00%	○	△1△2	0.00	○	○	○
<b>P15</b>	(Iron loss factor 3)	0.00% to 20.00%	○	△1△2	0.00	○	○	○
<b>P16</b>	(Magnetic saturation factor 1)	0.0% to 300.0%	○	△1△2	*7	○	○	○
<b>P17</b>	(Magnetic saturation factor 2)	0.0% to 300.0%	○	△1△2	*7	○	○	○
<b>P18</b>	(Magnetic saturation factor 3)	0.0% to 300.0%	○	△1△2	*7	○	○	○
<b>P19</b>	(Magnetic saturation factor 4)	0.0% to 300.0%	○	△1△2	*7	○	○	○
<b>P20</b>	(Magnetic saturation factor 5)	0.0% to 300.0%	○	△1△2	*7	○	○	○
<b>P21</b>	(Magnetic saturation extension factor "a")	0.0% to 300.0%	○	△1△2	*7	○	○	○
<b>P22</b>	(Magnetic saturation extension factor "b")	0.0% to 300.0%	○	△1△2	*7	○	○	○
<b>P23</b>	(Magnetic saturation extension factor "c")	0.0% to 300.0%	○	△1△2	*7	○	○	○
<b>P53</b>	(%X correction factor 1)	0% to 300%	○	△1△2	100	○	○	○
<b>P54</b>	(%X correction factor 2)	0% to 300%	○	△1△2	100	○	○	○
<b>P55</b>	(Torque current under vector control)	0.00 to 2000 A	None	△1△2	*7	None	○	○
<b>P56</b>	(Induced voltage factor under vector control)	50% to 100%	None	△1△2	85	None	○	○
<b>P57</b>	Reserved *9	0.000 to 20.000 s	○	△1△2	0.082	—	—	—
<b>P99</b>	Motor 1 Selection	0 : Motor characteristics 0 (Fuji standard motors, 8-series) 1 : Motor characteristics 1 (HP rating motors) 2 : Motor characteristics 2 (Fuji motors exclusively designed for vector control) 3 : Motor characteristics 3 (Fuji standard motors, 6-series) 4 : Other motors	None	△1△2	0	○	○	○

The shaded function codes ( ) are applicable to the quick setup.

\*7 The motor constant is automatically set, depending upon the inverter's capacity and shipping destination.

\*9 These function codes are reserved for particular manufacturers. Unless otherwise specified, do not access these function codes.

<Data change, reflection and strage>

None: Not available ○ : After changing data with using ⏏️⏏️ keys, execute and save data by pressing ⏏️ key,

☉ After changing and executing data with using ⏏️⏏️ keys, save the data by pressing ⏏️ key.

### Data copy

○	Data copy is enabled.
△1	Data copy is not enabled if the inverter capacities vary.
△2	Data copy is not enabled if the voltage classes vary.
None	Data copy is not enabled.

# Function Settings

## Function Settings

### ● H codes: High Performance Functions

Code	Name	Data setting range	Change when running	Data copying	Default setting	Drive control		
						V/f	W/O PG	W/PG
H03	Data Initialization	0 : Disable initialization 1 : Initialize all function code data to the factory defaults 2 : Initialize motor 1 parameters 3 : Initialize motor 2 parameters 4 : Initialize motor 3 parameters 5 : Initialize motor 4 parameters	None	None	0	○	○	○
H04	Auto-reset (Times)	0 : Disable; 1 to 10	○	○	0	○	○	○
H05	(Reset interval)	0.5 to 20.0 s	○	○	5.0	○	○	○
H06	Cooling Fan ON/OFF Control	0 : Disable (Always in operation) 1 : Enable (ON/OFF controllable)	○	○	0	○	○	○
H07	Acceleration/Deceleration Pattern	0 : Linear 1 : S-curve (Weak) 2 : S-curve (Arbitrary, according to H57 to H60 data) 3 : Curvilinear	○	○	0	○	○	○
H08	Rotational Direction Limitation	0 : Disable 1 : Enable (Reverse rotation inhibited) 2 : Enable (Forward rotation inhibited)	None	○	0	○	○	○
H09	Starting Mode (Auto search)	0 : Disable 1 : Enable (At restart after momentary power failure) 2 : Enable (At restart after momentary power failure and at normal start)	None	○	0	○	None	None
H11	Deceleration Mode	0 : Normal deceleration 1: Coast-to-stop	○	○	0	○	○	○
H12	Instantaneous Overcurrent Limiting (Mode selection)	0 : Disable 1 : Enable	○	○	1	○	None	None
H13	Restart Mode after Momentary (Restart time)	0.1 to 10.0 s	○	△1△2	*3	○	○	○
H14	Power Failure (Frequency fall rate)	0.00: Deceleration time selected by F08, 0.01 to 100.00 Hz/s, 999: Follow the current limit command	○	○	999	○	○	○
H15	(Continuous running level)	200 to 300 V for 200 V class series 400 to 600 V for 400 V class series	○	△2	235 470	○	○	○
H16	(Allowable momentary power failure time)	0.0 to 30.0 s 999: Automatically determined by inverter	○	○	999	○	○	○
H26	Thermistor (for motor) (Mode selection)	0 : Disable 1 : PTC (The inverter immediately trips with OH4 displayed.) 2 : PTC (The inverter issues output signal THM and continues to run.) 3 : NTC (When connected)	○	○	0	○	○	○
H27	(Level)	0.00 to 5.00 V	○	○	0.35	○	○	○
H28	Droop Control	60.0 to 0.0 Hz	○	○	0.0	○	○	○
H30	Communications Link Function (Mode selection)	Frequency command Run command 0 : F01/C30 F02 1 : RS-485 (Port 1) F02 2 : F01/C30 RS-485 (Port 1) 3 : RS-485 (Port 1) RS-485 (Port 1) 4 : RS-485 (Port 2) F02 5 : RS-485 (Port 2) RS-485 (Port 1) 6 : F01/C30 RS-485 (Port 2) 7 : RS-485 (Port 1) RS-485 (Port 2) 8 : RS-485 (Port 2) RS-485 (Port 2)	○	○	0	○	○	○
H42	Capacitance of DC Link Bus Capacitor	Indication for replacement of DC link bus capacitor 0000 to FFFF (hex.)	○	None	—	○	○	○
H43	Cumulative Run Time of Cooling Fan	Indication for replacement of cooling fan (in units of 10 hours)	○	None	—	○	○	○
H44	Startup Counter for Motor 1	Indication of cumulative startup count 0000 to FFFF (hex.)	○	None	—	○	○	○
H45	Mock Alarm	0 : Disable 1 : Enable (Once a mock alarm occurs, the data automatically returns to 0.)	○	None	0	○	○	○
H46	Starting Mode (Auto search delay time 2)	0.1 to 10.0 s	○	△1△2	*7	○	○	None
H47	Initial Capacitance of DC Link Bus Capacitor	Indication for replacement of DC link bus capacitor 0000 to FFFF (hex.)	○	None	—	○	○	○
H48	Cumulative Run Time of Capacitors on Printed Circuit Boards	Indication for replacement of capacitors (The cumulative run time can be modified or reset in units of 10 hours.)	○	None	—	○	○	○
H49	Starting Mode (Auto search delay time 1)	0.0 to 10.0 s	○	○	0.0	○	○	○
H50	Non-linear V/f Pattern 1 (Frequency)	0.0: Cancel, 0.1 to 500.0 Hz	None	○	*8	○	None	None
H51	(Voltage)	0 to 240: Output an AVR-controlled voltage (for 200 V class series) 0 to 500: Output an AVR-controlled voltage (for 400 V class series)	None	△2	*8	○	None	None
H52	Non-linear V/f Pattern 2 (Frequency)	0.0: Cancel, 0.1 to 500.0 Hz	None	○	0.0	○	None	None
H53	(Voltage)	0 to 240: Output an AVR-controlled voltage (for 200 V class series) 0 to 500: Output an AVR-controlled voltage (for 400 V class series)	None	△2	0	○	None	None
H54	Acceleration Time (Jogging)	0.00 to 6000 s	○	○	*2	○	○	○
H55	Deceleration Time (Jogging)	0.00 to 6000 s	○	○	*2	○	○	○
H56	Deceleration Time for Forced Stop	0.00 to 6000 s	○	○	*2	○	○	○
H57	1st S-curve acceleration range (Leading edge)	0% to 100%	○	○	10	○	○	○
H58	2nd S-curve acceleration range (Trailing edge)	0% to 100%	○	○	10	○	○	○
H59	1st S-curve deceleration range (Leading edge)	0% to 100%	○	○	10	○	○	○
H60	2nd S-curve deceleration range (Trailing edge)	0% to 100%	○	○	10	○	○	○
H61	UP/DOWN Control (Initial frequency setting)	0 : 0.00 Hz 1 : Last UP/DOWN command value on releasing the run command	None	○	1	○	○	○
H63	Low Limiter (Mode selection)	0 : Limit by F16 (Frequency limiter: Low) and continue to run 1 : If the output frequency lowers below the one limited by F16 (Frequency limiter: Low), decelerate to stop the motor.	○	○	0	○	○	○
H64	(Lower limiting frequency)	0.0: Depends on F16 (Frequency limiter, Low) 0.1 to 60.0 Hz	○	○	1.6	○	None	None
H65	Non-linear V/f Pattern 3 (Frequency)	0.0: Cancel, 0.1 to 500.0 Hz	None	○	0.0	○	None	None
H66	(Voltage)	0 to 240: Output an AVR-controlled voltage (for 200 V class series) 0 to 500: Output an AVR-controlled voltage (for 400 V class series)	None	△2	0	○	None	None
H67	Auto Energy Saving Operation (Mode selection)	0 : Enable during running at constant speed 1 : Enable in all modes	○	○	0	○	None	○
H68	Slip Compensation 1 (Operating conditions)	0 : Enable during ACC/DEC and at base frequency or above 1 : Disable during ACC/DEC and enable at base frequency or above 2 : Enable during ACC/DEC and disable at base frequency or above 3 : Disable during ACC/DEC and at base frequency or above	None	○	0	○	None	None



## H codes: High Performance Functions

Code	Name	Data setting range	Change when running	Data copying	Default setting	Drive control		
						V/f	W/O PG	W/PG
H69	Automatic Deceleration (Mode selection)	0 : Disable 2 : Torque limit control with Force-to-stop if actual deceleration time exceeds three times the specified one 3 : DC link bus voltage control with Force-to-stop if actual deceleration time exceeds three times the specified one 4 : Torque limit control with Force-to-stop disabled 5 : DC link bus voltage control with Force-to-stop disabled	○	○	0	○	○	○
H70	Overload Prevention Control	0.00: Follow the deceleration time selected 0.01 to 100.0 Hz/s 999: Cancel	○	○	999	○	○	○
H71	Deceleration Characteristics	0 : Disable 1 : Enable	○	○	0	○	None	None
H72	Main Power Down Detection (Mode selection)	0 : Disable 1 : Enable	○	○	1	○	○	○
H73	Torque Limiter (Operating conditions)	0 : Enable during ACC/DEC and running at constant speed 1 : Disable during ACC/DEC and enable during running at constant speed 2 : Enable during ACC/DEC and disable during running at constant speed	None	○	0	○	○	○
H76	(Frequency increment limit for braking)	0.0 to 500.0 Hz	○	○	5.0	○	None	None
H77	Service Life of DC Link Bus Capacitor (Remaining time)	0 to 8760 (in units of 10 hours)	○	None	—	○	○	○
H78	Maintenance Interval (M1)	0: Disable; 1 to 9999 (in units of 10 hours)	○	None	8760	○	○	○
H79	Preset Startup Count for Maintenance (M1)	0000: Disable; 0001 to FFFF (hex.)	○	None	0	○	○	○
H80	Output Current Fluctuation Damping Gain for Motor 1	0.00 to 0.40	○	○	0.20 *10	○	None	None
H81	Light Alarm Selection 1	0000 to FFFF (hex.)	○	○	0	○	○	○
H82	Light Alarm Selection 2	0000 to FFFF (hex.)	○	○	0	○	○	○
H84	Pre-excitation (Initial level)	100% to 400%	○	○	100	None	○	○
H85	(Time)	0.00: Disable; 0.01 to 30.00 s	○	○	0.00	None	○	○
H86	Reserved *9	0 to 2	○	△1△2	0 *11	—	—	—
H87	Reserved *9	25.0 to 500.0 Hz	○	○	25.0	—	—	—
H88	Reserved *9	0 to 3; 999	○	None	0	—	—	—
H89	Reserved *9	0, 1	○	○	0	—	—	—
H90	Reserved *9	0, 1	○	○	0	—	—	—
H91	PID Feedback Wire Break Detection	0.0: Disable alarm detection 0.1 to 60.0 s	○	○	0.0	○	○	○
H92	Continuity of Running (P)	0.000 to 10.000 times; 999	○	△1△2	999	○	○	○
H93	(I)	0.010 to 10.000 s; 999	○	△1△2	999	○	○	○
H94	Cumulative Motor Run Time 1	0 to 9999 (The cumulative run time can be modified or reset in units of 10 hours.)	None	None	—	○	○	○
H95	DC Braking (Braking response mode)	0 : Slow 1 : Quick	○	○	1	○	None	None
H96	STOP Key Priority/ Start Check Function	Data STOP key priority Start check function 0: Disable Disable 1: Enable Disable 2: Disable Enable 3: Enable Enable	○	○	0	○	○	○
H97	Clear Alarm Data	0 : Disable 1 : Enable (Setting "1" clears alarm data and then returns to "0.")	○	None	0	○	○	○
H98	Protection/Maintenance Function (Mode selection)	0 to 255: Display data in decimal format Bit 0: Lower the carrier frequency automatically (0: Disabled; 1: Enabled) Bit 1: Detect input phase loss (0: Disabled; 1: Enabled) Bit 2: Detect output phase loss (0: Disabled; 1: Enabled) Bit 3: Select life judgment threshold of DC link bus capacitor(0: Factory default level; 1: User setup level) Bit 4: Judge the life of DC link bus capacitor (0: Disabled; 1: Enabled) Bit 5: Detect DC fan lock (0: Enabled; 1: Disabled) Bit 6: Detect braking transistor error(for 22 kW or below) (0: Disabled; 1: Enabled) Bit 7: IP20/IP40 switching (0: IP20; 1: IP40)	○	○	83	○	○	○

## A codes: Motor 2 Parameters

Code	Name	Data setting range	Change when running	Data copying	Default setting	Drive control		
						V/f	W/O PG	W/PG
R01	Maximum Frequency 2	25.0 to 500.0 Hz	None	○	*1	○	○	○
R02	Base Frequency 2	25.0 to 500.0 Hz	None	○	50.0	○	○	○
R03	Rated Voltage at Base Frequency 2	0 : Output a voltage in proportion to input voltage 80 to 240 : Output an AVR-controlled voltage (for 200 V class series) 160 to 500 : Output an AVR-controlled voltage (for 400 V class series)	None	△2	*1	○	○	○
R04	Maximum Output Voltage 2	80 to 240 : Output an AVR-controlled voltage (for 200 V class series) 160 to 500 : Output an AVR-controlled voltage (for 400 V class series)	None	△2	*1	○	None	None
R05	Torque Boost 2	0.0% to 20.0% (percentage with respect to "A03:Rated Voltage at Base Frequency 2")	○	○	*3	○	None	None
R06	Electronic Thermal Overload Protection for Motor 2 (Select motor characteristics)	1 : For a general-purpose motor with shaft-driven cooling fan 2 : For an inverter-driven motor, non-ventilated motor, or motor with separately powered cooling fan	○	○	1	○	○	○
R07	(Overload detection level)	0.00: Disable 1% to 135% of the rated current (allowable continuous drive current) of the motor	○	△1△2	*4	○	○	○
R08	(Thermal time constant)	0.5 to 75.0 min	○	○	*5	○	○	○
R09	DC Braking 2 (Braking starting frequency)	0.0 to 60.0 Hz	○	○	0.0	○	○	○
R10	(Braking level)	0% to 100% (HD mode), 0% to 80% (LD mode)	○	○	0	○	○	○
R11	(Braking time)	0.00: Disable; 0.01 to 30.00 s	○	○	0.00	○	○	○
R12	Starting Frequency 2	0.0 to 60.0 Hz	○	○	0.5	○	○	○
R13	Load Selection/ Auto Torque Boost/ Auto Energy Saving Operation 2	0 : Variable torque load 1 : Constant torque load 2 : Auto-torque boost 3 : Auto-energy saving operation(Variable torque load during ACC/DEC) 4 : Auto-energy saving operation(Constant torque load during ACC/DEC) 5 : Auto-energy saving operation(Auto-torque boost during ACC/DEC)	None	○	1	○	None	○

\*1 The factory default differs depending upon the shipping destination.

\*2 6.00 s for inverters with a capacity of 22 kW or below; 20.00 s for those with 30 kW or above.

\*3 The factory default differs depending upon the inverter's capacity.

\*4 The motor rated current is automatically set.

\*5 5.0 min for inverters with a capacity of 22 kW or below; 10.0 min for those with 30 kW or above.

\*6 The motor constant is automatically set, depending upon the inverter's capacity and shipping destination.

\*7 The factory default differs depending upon the inverter's capacity.

\*8 These function codes are reserved for particular manufacturers. Unless otherwise specified, do not access these function codes.

\*9 0.10 for 200 V class series of inverters with a capacity of 37 kW or above.

\*11 2 for 200 V class series of inverters with a capacity of 37 kW or above.

<Data change, reflection and strage>

None: Not available ○: After changing data with using ▲▼ keys, execute and save data by pressing ⏻ key,

⏻ After changing and executing data with using ▲▼ keys, save the data by pressing ⏻ key.

### Data copy

○	Data copy is enabled.
△1	Data copy is not enabled if the inverter capacities vary.
△2	Data copy is not enabled if the voltage classes vary.
None	Data copy is not enabled.

# Function Settings

## Function Settings

### ● A codes: Motor 2 Parameters

Code	Name	Data setting range	Change when running	Data copying	Default setting	Drive control		
						V/f	W/O PG	W/PG
<b>A14</b>	Drive Control Selection 2	0 : V/f control with slip compensation inactive 1 : Dynamic torque vector control 2 : V/f control with slip compensation active 5 : Vector control without speed sensor 6 : Vector control with speed sensor	None	○	0	○	○	○
<b>A15</b>	Motor 2 (No. of poles)	2 to 22 poles	None	△1△2	4	○	○	○
<b>A16</b>	(Rated capacity)	0.01 to 1000 kW (when A39 = 0, 2, 3 or 4) 0.01 to 1000 HP (when A39 = 1)	None	△1△2	*7	○	○	○
<b>A17</b>	(Rated current)	0.00 to 2000 A	None	△1△2	*7	○	○	○
<b>A18</b>	(Auto-tuning)	0 : Disable 1 : Tune while the motor stops. (%R1, %X and rated slip frequency) 2 : Tune while the motor is rotating under V/f control (%R1, %X, rated slip frequency, no-load current, magnetic saturation factors 1 to 5, and magnetic saturation extension factors "a" to "c") 3 : Tune while the motor is rotating under vector control (%R1, %X, rated slip frequency, no-load current, magnetic saturation factors 1 to 5, and magnetic saturation extension factors "a" to "c." Available when the vector control is enabled.)	None	None	0	○	○	○
<b>A20</b>	(No-load current)	0.00 to 2000 A	None	△1△2	*7	○	○	○
<b>A21</b>	(%R1)	0.00% to 50.00%	○	△1△2	*7	○	○	○
<b>A22</b>	(%X)	0.00% to 50.00%	○	△1△2	*7	○	○	○
<b>A23</b>	(Slip compensation gain for driving)	0.0% to 200.0%	◎	○	100.0	○	○	○
<b>A24</b>	(Slip compensation response time)	0.01 to 10.00s	○	△1△2	0.12	○	None	None
<b>A25</b>	(Slip compensation gain for braking)	0.0% to 200.0%	◎	○	100.0	○	○	○
<b>A26</b>	(Rated slip frequency)	0.00 to 15.00 Hz	None	△1△2	*7	○	○	○
<b>A27</b>	(Iron loss factor 1)	0.00% to 20.00%	○	△1△2	*7	○	○	○
<b>A28</b>	(Iron loss factor 2)	0.00% to 20.00%	○	△1△2	0.00	○	○	○
<b>A29</b>	(Iron loss factor 3)	0.00% to 20.00%	○	△1△2	0.00	○	○	○
<b>A30</b>	(Magnetic saturation factor 1)	0.0% to 300.0%	○	△1△2	*7	○	○	○
<b>A31</b>	(Magnetic saturation factor 2)	0.0% to 300.0%	○	△1△2	*7	○	○	○
<b>A32</b>	(Magnetic saturation factor 3)	0.0% to 300.0%	○	△1△2	*7	○	○	○
<b>A33</b>	(Magnetic saturation factor 4)	0.0% to 300.0%	○	△1△2	*7	○	○	○
<b>A34</b>	(Magnetic saturation factor 5)	0.0% to 300.0%	○	△1△2	*7	○	○	○
<b>A35</b>	(Magnetic saturation extension factor "a")	0.0% to 300.0%	○	△1△2	*7	○	○	○
<b>A36</b>	(Magnetic saturation extension factor "b")	0.0% to 300.0%	○	△1△2	*7	○	○	○
<b>A37</b>	(Magnetic saturation extension factor "c")	0.0% to 300.0%	○	△1△2	*7	○	○	○
<b>A39</b>	Motor 2 Selection	0 : Motor characteristics 0 (Fuji standard motors, 8-series) 1 : Motor characteristics 1 (HP rating motors) 2 : Motor characteristics 2 (Fuji motors exclusively designed for vector control) 3 : Motor characteristics 3 (Fuji standard motors, 6-series) 4 : Other motors	None	△1△2	0	○	○	○
<b>A40</b>	Slip Compensation 2 (Operating conditions)	0 : Enable during ACC/DEC and at base frequency or above 1 : Disable during ACC/DEC and enable at base frequency or above 2 : Enable during ACC/DEC and disable at base frequency or above 3 : Disable during ACC/DEC and at base frequency or above	None	○	0	○	None	None
<b>A41</b>	Output Current Fluctuation Damping Gain for Motor 2	0.00 to 0.40	○	○	0.20	○	None	None
<b>A42</b>	Motor/Parameter Switching 2 (Mode selection)	0 : Motor (Switch to the 2nd motor) 1 : Parameter (Switch to particular A codes)	None	○	0	○	○	○
<b>A43</b>	Speed Control 2 (Speed command filter)	0.000 to 5.000 s	○	○	0.020	None	○	○
<b>A44</b>	(Speed detection filter)	0.000 to 0.100 s	◎	○	0.005	None	○	○
<b>A45</b>	P (Gain)	0.1 to 200.0 times	◎	○	10.0	None	○	○
<b>A46</b>	I (Integral time)	0.001 to 1.000 s	◎	○	0.100	None	○	○
<b>A48</b>	(Output filter)	0.000 to 0.100 s	○	○	0.002	None	○	○
<b>A51</b>	Cumulative Motor Run Time 2	0 to 9999 (The cumulative run time can be modified or reset in units of 10 hours.)	None	None	—	○	○	○
<b>A52</b>	Startup Counter for Motor 2	Indication of cumulative startup count 0000 to FFFF (hex.)	○	None	—	○	○	○
<b>A53</b>	Motor 2 (%X correction factor 1)	0% to 300%	○	△1△2	100	○	○	○
<b>A54</b>	(%X correction factor 2)	0% to 300%	○	△1△2	100	○	○	○
<b>A55</b>	(Torque current under vector control)	0.00 to 2000 A	None	△1△2	*7	None	○	○
<b>A56</b>	(Induced voltage factor under vector control)	50 to 100	None	△1△2	85	None	○	○
<b>A57</b>	Reserved *9	0.000 to 20.000 s	None	△1△2	0.082	—	—	—

### ● b codes: Motor 3 Parameters

Code	Name	Data setting range	Change when running	Data copying	Default setting	Drive control		
						V/f	W/O PG	W/PG
<b>b01</b>	Maximum Frequency 3	25.0 to 500.0 Hz	None	○	*1	○	○	○
<b>b02</b>	Base Frequency 3	25.0 to 500.0 Hz	None	○	50.0	○	○	○
<b>b03</b>	Rated Voltage at Base Frequency 3	0 : Output a voltage in proportion to input voltage 80 to 240 : Output an AVR-controlled voltage(for 200 V class series) 160 to 500 : Output an AVR-controlled voltage(for 400 V class series)	None	△2	*1	○	○	○
<b>b04</b>	Maximum Output Voltage 3	80 to 240 : Output an AVR-controlled voltage(for 200 V class series) 160 to 500 : Output an AVR-controlled voltage(for 400 V class series)	None	△2	*1	○	None	None
<b>b05</b>	Torque Boost 3	0.0% to 20.0%(percentage with respect to "b03: Rated Voltage at Base Frequency 3")	○	○	*3	○	None	None
<b>b06</b>	Electronic Thermal Overload Protection for Motor 3 (Select motor characteristics)	1 : For a general-purpose motor with shaft-driven cooling fan 2 : For an inverter-driven motor, non-ventilated motor, or motor with separately powered cooling fan	○	○	1	○	○	○
<b>b07</b>	(Overload detection level)	0.00: Disable 1% to 135% of the rated current (allowable continuous drive current) of the motor	○	△1△2	*4	○	○	○
<b>b08</b>	(Thermal time constant)	0.5 to 75.0 min	○	○	*5	○	○	○
<b>b09</b>	DC Braking 3 (Braking starting frequency)	0.0 to 60.0 Hz	○	○	0.0	○	○	○
<b>b10</b>	(Braking level)	0% to 100% (HD mode), 0% to 80% (LD mode)	○	○	0	○	○	○
<b>b11</b>	(Braking time)	0.00: Disable; 0.01 to 30.00 s	○	○	0.00	○	○	○
<b>b12</b>	Starting Frequency 3	0.0 to 60.0 Hz	○	○	0.5	○	○	○
<b>b13</b>	Load Selection/ Auto Torque Boost/ Auto Energy Saving Operation 3	0 : Variable torque load 1 : Constant torque load 2 : Auto-torque boost 3 : Auto-energy saving operation(Variable torque load during ACC/DEC) 4 : Auto-energy saving operation(Constant torque load during ACC/DEC) 5 : Auto-energy saving operation(Auto-torque boost during ACC/DEC)	None	○	1	○	None	○

**b codes: Motor 3 Parameters**

Code	Name	Data setting range	Change when running	Data copying	Default setting	Drive control		
						V/f	W/O PG	W/PG
b14	Drive Control Selection 3	0 : V/f control with slip compensation inactive 1 : Dynamic torque vector control 2 : V/f control with slip compensation active 5 : Vector control without speed sensor 6 : Vector control with speed sensor	None	○	0	○	○	○
b15	Motor 3 (No. of poles)	2 to 22 poles	None	△1△2	4	○	○	○
b16	(Rated capacity)	0.01 to 1000 kW (when b39 = 0, 2, 3 or 4) 0.01 to 1000 HP (when b39 = 1)	None	△1△2	*7	○	○	○
b17	(Rated current)	0.00 to 2000 A	None	△1△2	*7	○	○	○
b18	(Auto-tuning)	0 : Disable 1 : Tune while the motor stops. (%R1, %X and rated slip frequency) 2 : Tune while the motor is rotating under V/f control (%R1, %X, rated slip frequency, no-load current, magnetic saturation factors 1 to 5, and magnetic saturation extension factors "a" to "c") 3 : Tune while the motor is rotating under vector control (%R1, %X, rated slip frequency, no-load current, magnetic saturation factors 1 to 5, and magnetic saturation extension factors "a" to "c". Available when the vector control is enabled).	None	None	0	○	○	○
b20	(No-load current)	0.00 to 2000 A	None	△1△2	*7	○	○	○
b21	(%R1)	0.00% to 50.00%	○	△1△2	*7	○	○	○
b22	(%X)	0.00% to 50.00%	○	△1△2	*7	○	○	○
b23	(Slip compensation gain for driving)	0.0% to 200.0%	⊙	○	100.0	○	○	○
b24	(Slip compensation response time)	0.01 to 10.00 s	○	△1△2	0.12	○	None	None
b25	(Slip compensation gain for braking)	0.0% to 200.0%	⊙	○	100.0	○	○	○
b26	(Rated slip frequency)	0.00 to 15.00 Hz	None	△1△2	*7	○	○	○
b27	(Iron loss factor 1)	0.00% to 20.00%	○	△1△2	*7	○	○	○
b28	(Iron loss factor 2)	0.00% to 20.00%	○	△1△2	0.00	○	○	○
b29	(Iron loss factor 3)	0.00% to 20.00%	○	△1△2	0.00	○	○	○
b30	(Magnetic saturation factor 1)	0.0% to 300.0%	○	△1△2	*7	○	○	○
b31	(Magnetic saturation factor 2)	0.0% to 300.0%	○	△1△2	*7	○	○	○
b32	(Magnetic saturation factor 3)	0.0% to 300.0%	○	△1△2	*7	○	○	○
b33	(Magnetic saturation factor 4)	0.0% to 300.0%	○	△1△2	*7	○	○	○
b34	(Magnetic saturation factor 5)	0.0% to 300.0%	○	△1△2	*7	○	○	○
b35	(Magnetic saturation extension factor "a")	0.0% to 300.0%	○	△1△2	*7	○	○	○
b36	(Magnetic saturation extension factor "b")	0.0% to 300.0%	○	△1△2	*7	○	○	○
b37	(Magnetic saturation extension factor "c")	0.0% to 300.0%	○	△1△2	*7	○	○	○
b39	Motor 3 Selection	0 : Motor characteristics 0 (Fuji standard motors, 8-series) 1 : Motor characteristics 1 (HP rating motors) 2 : Motor characteristics 2 (Fuji motors exclusively designed for vector control) 3 : Motor characteristics 3 (Fuji standard motors, 6-series) 4 : Other motors	None	△1△2	0	○	○	○
b40	Slip Compensation 3 (Operating conditions)	0 : Enable during ACC/DEC and at base frequency or above 1 : Disable during ACC/DEC and enable at base frequency or above 2 : Enable during ACC/DEC and disable at base frequency or above 3 : Disable during ACC/DEC and at base frequency or above	None	○	0	○	None	None
b41	Output Current Fluctuation Damping Gain for Motor 3	0.00 to 0.40	○	○	0.20	○	None	None
b42	Motor/Parameter Switching 3 (Mode selection)	0 : Motor (Switch to the 3rd motor) 1 : Parameter (Switch to particular b codes)	None	○	0	○	○	○
b43	Speed Control 3 (Speed command filter)	0.000 to 5.000 s	○	○	0.020	None	○	○
b44	(Speed detection filter)	0.000 to 0.100 s	⊙	○	0.005	None	○	○
b45	P (Gain)	0.1 to 200.0 times	⊙	○	10.0	None	○	○
b46	I (Integral time)	0.001 to 1.000 s	⊙	○	0.100	None	○	○
b48	(Output filter)	0.000 to 0.100 s	○	○	0.020	None	○	○
b51	Cumulative Motor Run Time 3	0 to 9999 (The cumulative run time can be modified or reset in units of 10 hours.)	None	None	—	○	○	○
b52	Startup Counter for Motor 3	Indication of cumulative startup count 0000 to FFFF (hex.)	○	None	—	○	○	○
b53	Motor 3 (%X correction factor 1)	0% to 300%	○	△1△2	100	○	○	○
b54	(%X correction factor 2)	0% to 300%	○	△1△2	100	○	○	○
b55	Motor3 (Torque current under vector control)	0.00 to 2000 A	None	△1△2	*7	None	○	○
b56	(Induced voltage factor under vector control)	50 to 100	None	△1△2	85	None	○	○
b57	Reserved *9	0.000 to 20.000 s	None	△1△2	0.082	—	—	—

**r codes: Motor 4 Parameters**

Code	Name	Data setting range	Change when running	Data copying	Default setting	Drive control		
						V/f	W/O PG	W/PG
r01	Maximum Frequency 4	25.0 to 500.0 Hz	None	○	*1	○	○	○
r02	Base Frequency 4	25.0 to 500.0 Hz	None	○	50.0	○	○	○
r03	Rated Voltage at Base Frequency 4	0 : Output a voltage in proportion to input voltage 80 to 240 : Output an AVR-controlled voltage(for 200 V class series) 160 to 500 : Output an AVR-controlled voltage(for 400 V class series)	None	△2	*1	○	○	○
r04	Maximum Output Voltage 4	80 to 240 : Output an AVR-controlled voltage(for 200 V class series) 160 to 500 : Output an AVR-controlled voltage(for 400 V class series)	None	△2	*1	○	○	None
r05	Torque Boost 4	0.0% to 20.0%(percentage with respect to "r03:Rated Voltage at Base Frequency 4")	○	○	*3	○	None	None
r06	Electronic Thermal Overload Protection for Motor 4 (Select motor characteristics)	1 : For a general-purpose motor with shaft-driven cooling fan 2 : For an inverter-driven motor, non-ventilated motor, or motor with separately powered cooling fan	○	○	1	○	○	○
r07	(Overload detection level)	0.00: Disable 1% to 135% of the rated current (allowable continuous drive current) of the motor	○	△1△2	*4	○	○	○
r08	(Thermal time constant)	0.5 to 75.0 min	○	○	*5	○	○	○
r09	DC Braking 4 (Braking starting frequency)	0.0 to 60.0 Hz	○	○	0.0	○	○	○
r10	(Braking level)	0% to 100% (HD mode), 0% to 80% (LD mode)	○	○	0	○	○	○
r11	(Braking time)	0.00: Disable; 0.01 to 30.00 s	○	○	0.00	○	○	○
r12	Starting Frequency 4	0.0 to 60.0 Hz	○	○	0.5	○	○	○

\*1 The factory default differs depending upon the shipping destination.

\*3 The factory default differs depending upon the inverter's capacity.

\*4 The motor rated current is automatically set.

\*5 5.0 min for inverters with a capacity of 22 kW or below; 10.0 min for those with 30 kW or above.

\*7 The motor constant is automatically set, depending upon the inverter's capacity and shipping destination.

\*9 These function codes are reserved for particular manufacturers. Unless otherwise specified, do not access these function codes.

<Data change, reflection and strage>

[None] : Not available [○] : After changing data with using ▲▼ keys, execute and save data by pressing ⏻ key,

⊙ After changing and executing data with using ▲▼ keys, save the data by pressing ⏻ key.

Data copy

○	Data copy is enabled.
△1	Data copy is not enabled if the inverter capacities vary.
△2	Data copy is not enabled if the voltage classes vary.
None	Data copy is not enabled.

# Function Settings

## Function Settings

### ● r codes: Motor 4 Parameters

Code	Name	Data setting range	Change when running	Data copying	Default setting	Drive control		
						V/f	W/O PG	W/PG
r 13	Load Selection/ Auto Torque Boost/ Auto Energy Saving Operation 4	0 : Variable torque load 1 : Constant torque load 2 : Auto-torque boost 3 : Auto-energy saving operation (Variable torque load during ACC/DEC) 4 : Auto-energy saving operation (Constant torque load during ACC/DEC) 5 : Auto-energy saving operation (Auto-torque boost during ACC/DEC)	None	○	1	○	None	○
r 14	Drive Control Selection 4	0 : V/f control with slip compensation inactive 1 : Dynamic torque vector control 2 : V/f control with slip compensation active 5 : Vector control without speed sensor 6 : Vector control with speed sensor	None	○	0	○	○	○
r 15	Motor 4 (No. of poles)	2 to 22 poles	None	△1△2	4	○	○	○
r 16	(Rated capacity)	0.01 to 1000 kW (when r39 = 0, 2, 3 or 4) 0.01 to 1000 HP (when r39 = 1)	None	△1△2	*7	○	○	○
r 17	(Rated current)	0.00 to 2000 A	None	△1△2	*7	○	○	○
r 18	(Auto-tuning)	0 : Disable 1 : Tune while the motor stops. (%R1, %X and rated slip frequency) 2 : Tune while the motor is rotating under V/f control (%R1, %X, rated slip frequency, no-load current, magnetic saturation factors 1 to 5, and magnetic saturation extension factors "a" to "c") 3 : Tune while the motor is rotating under vector control (%R1, %X, rated slip frequency, no-load current, magnetic saturation factors 1 to 5, and magnetic saturation extension factors "a" to "c." Available when the vector control is enabled.)	None	None	0	○	○	○
r 20	(No-load current)	0.00 to 2000 A	None	△1△2	*7	○	○	○
r 21	(%R1)	0.00% to 50.00%	○	△1△2	*7	○	○	○
r 22	(%X)	0.00% to 50.00%	○	△1△2	*7	○	○	○
r 23	(Slip compensation gain for driving)	0.0% to 200.0%	◎	○	100.0	○	○	○
r 24	(Slip compensation response time)	0.01 to 10.00 s	○	△1△2	0.12	○	None	None
r 25	(Slip compensation gain for braking)	0.0% to 200.0%	◎	○	100.0	○	○	○
r 26	(Rated slip frequency)	0.00 to 15.00 Hz	None	△1△2	*7	○	○	○
r 27	(Iron loss factor 1)	0.00% to 20.00%	○	△1△2	*7	○	○	○
r 28	(Iron loss factor 2)	0.00% to 20.00%	○	△1△2	0.00	○	○	○
r 29	(Iron loss factor 3)	0.00% to 20.00%	○	△1△2	0.00	○	○	○
r 30	(Magnetic saturation factor 1)	0.0% to 300.0%	○	△1△2	*7	○	○	○
r 31	(Magnetic saturation factor 2)	0.0% to 300.0%	○	△1△2	*7	○	○	○
r 32	(Magnetic saturation factor 3)	0.0% to 300.0%	○	△1△2	*7	○	○	○
r 33	(Magnetic saturation factor 4)	0.0% to 300.0%	○	△1△2	*7	○	○	○
r 34	(Magnetic saturation factor 5)	0.0% to 300.0%	○	△1△2	*7	○	○	○
r 35	(Magnetic saturation extension factor "a")	0.0% to 300.0%	○	△1△2	*7	○	○	○
r 36	(Magnetic saturation extension factor "b")	0.0% to 300.0%	○	△1△2	*7	○	○	○
r 37	(Magnetic saturation extension factor "c")	0.0% to 300.0%	○	△1△2	*7	○	○	○
r 39	Motor 4 Selection	0 : Motor characteristics 0 (Fuji standard motors, 8-series) 1 : Motor characteristics 1 (HP rating motors) 2 : Motor characteristics 2 (Fuji motors exclusively designed for vector control) 3 : Motor characteristics 3 (Fuji standard motors, 6-series) 4 : Other motors	None	△1△2	0	○	○	○
r 40	Slip Compensation 4 (Operating conditions)	0 : Enable during ACC/DEC and at base frequency or above 1 : Disable during ACC/DEC and enable at base frequency or above 2 : Enable during ACC/DEC and disable at base frequency or above 3 : Disable during ACC/DEC and at base frequency or above	None	○	0	○	None	None
r 41	Output Current Fluctuation Damping Gain for Motor 4	0.00 to 0.40	○	○	0.20	○	None	None
r 42	Motor/Parameter Switching 4 (Mode selection)	0 : Motor (Switch to the 4th motor) 1 : Parameter (Switch to particular r codes)	None	○	0	○	○	○
r 43	Speed Control 4 (Speed command filter)	0.000 to 5.000 s	○	○	0.020	None	○	○
r 44	(Speed detection filter)	0.000 to 0.100 s	◎	○	0.005	None	○	○
r 45	P (Gain)	0.1 to 200.0 times	◎	○	10.0	None	○	○
r 46	I (Integral time)	0.001 to 1.000 s	◎	○	0.100	None	○	○
r 48	(Output filter)	0.000 to 0.100 s	○	○	0.020	None	○	○
r 51	Cumulative Motor Run Time 4	0 to 9999 (The cumulative run time can be modified or reset in units of 10 hours.)	None	None	—	○	○	○
r 52	Startup Counter for Motor 4	Indication of cumulative startup count 0000 to FFFF (hex.)	○	None	—	○	○	○
r 53	Motor 4 (%X correction factor 1)	0% to 300%	○	△1△2	100	○	○	○
r 54	(%X correction factor 2)	0% to 300%	○	△1△2	100	○	○	○
r 55	(Torque current under vector control)	0.00 to 2000 A	None	△1△2	*7	None	○	○
r 56	(Induced voltage factor under vector control)	50 to 100	None	△1△2	85	None	○	○
r 57	Reserved *9	0.000 to 20.000 s	None	△1△2	0.082	—	—	—

## J codes: Application Functions 1

Code	Name	Data setting range	Change when running	Data copying	Default setting	Drive control		
						V/f	W/O PG	W/PG
J01	PID Control (Mode selection)	0 : Disable 1 : Enable (Process control, normal operation) 2 : Enable (Process control, inverse operation) 3 : Enable (Dancer control)	None	<input type="radio"/>	0	<input type="radio"/>	<input type="radio"/>	<input type="radio"/>
J02	(Remote command SV)	0 :  /  keys on keypad 1 : PID process command 1 (Analog input terminals [12], [C1], and [V2]) 3 : UP/DOWN 4 : Command via communications link	None	<input type="radio"/>	0	<input type="radio"/>	<input type="radio"/>	<input type="radio"/>
J03	P (Gain)	0.000 to 30.000 times	<input type="radio"/>	<input type="radio"/>	0.100	<input type="radio"/>	<input type="radio"/>	<input type="radio"/>
J04	I (Integral time)	0.0 to 3600.0 s	<input type="radio"/>	<input type="radio"/>	0.0	<input type="radio"/>	<input type="radio"/>	<input type="radio"/>
J05	D (Differential time)	0.00 to 600.00 s	<input type="radio"/>	<input type="radio"/>	0.00	<input type="radio"/>	<input type="radio"/>	<input type="radio"/>
J06	(Feedback filter)	0.0 to 900.0 s	<input type="radio"/>	<input type="radio"/>	0.5	<input type="radio"/>	<input type="radio"/>	<input type="radio"/>
J08	(Pressurization starting frequency)	0.0 to 500.0 Hz	<input type="radio"/>	<input type="radio"/>	0.0	<input type="radio"/>	<input type="radio"/>	<input type="radio"/>
J09	(Pressurizing time)	0 to 60 s	<input type="radio"/>	<input type="radio"/>	0	<input type="radio"/>	<input type="radio"/>	<input type="radio"/>
J10	(Anti reset windup)	0% to 200%	<input type="radio"/>	<input type="radio"/>	200	<input type="radio"/>	<input type="radio"/>	<input type="radio"/>
J11	(Select alarm output)	0 : Absolute-value alarm 1 : Absolute-value alarm (with Hold) 2 : Absolute-value alarm (with Latch) 3 : Absolute-value alarm (with Hold and Latch) 4 : Deviation alarm 5 : Deviation alarm (with Hold) 6 : Deviation alarm (with Latch) 7 : Deviation alarm (with Hold and Latch)	<input type="radio"/>	<input type="radio"/>	0	<input type="radio"/>	<input type="radio"/>	<input type="radio"/>
J12	(Upper level alarm (AH))	-100% to 100%	<input type="radio"/>	<input type="radio"/>	100	<input type="radio"/>	<input type="radio"/>	<input type="radio"/>
J13	(Lower level alarm (AL))	-100% to 100%	<input type="radio"/>	<input type="radio"/>	0	<input type="radio"/>	<input type="radio"/>	<input type="radio"/>
J15	(Stop frequency for slow flowrate)	0.0: Disable; 1.0 to 500.0 Hz	<input type="radio"/>	<input type="radio"/>	0.0	<input type="radio"/>	<input type="radio"/>	<input type="radio"/>
J16	(Slow flowrate level stop latency)	0 to 60 s	<input type="radio"/>	<input type="radio"/>	30	<input type="radio"/>	<input type="radio"/>	<input type="radio"/>
J17	(Starting frequency)	0.0 to 500.0 Hz	<input type="radio"/>	<input type="radio"/>	0.0	<input type="radio"/>	<input type="radio"/>	<input type="radio"/>
J18	(Upper limit of PID process output)	-150% to 150%; 999: Depends on setting of F15	<input type="radio"/>	<input type="radio"/>	999	<input type="radio"/>	<input type="radio"/>	<input type="radio"/>
J19	(Lower limit of PID process output)	-150% to 150%; 999: Depends on setting of F16	<input type="radio"/>	<input type="radio"/>	999	<input type="radio"/>	<input type="radio"/>	<input type="radio"/>
J21	Dew Condensation Prevention (Duty)	1% to 50%	<input type="radio"/>	<input type="radio"/>	1	<input type="radio"/>	<input type="radio"/>	<input type="radio"/>
J22	Commercial Power Switching Sequence	0 : Keep inverter operation (Stop due to alarm) 1 : Automatically switch to commercial-power operation	None	<input type="radio"/>	0	<input type="radio"/>	<input type="radio"/>	<input type="radio"/>
J56	PID Control (Speed command filter)	0.00 to 5.00 s	<input type="radio"/>	<input type="radio"/>	0.10	<input type="radio"/>	<input type="radio"/>	<input type="radio"/>
J57	(Dancer reference position)	-100% to 0% to 100%	<input type="radio"/>	<input type="radio"/>	0	<input type="radio"/>	<input type="radio"/>	<input type="radio"/>
J58	(Detection width of dancer position deviation)	0: Disable switching PID constant 1% to 100% (Manually set value)	<input type="radio"/>	<input type="radio"/>	0	<input type="radio"/>	<input type="radio"/>	<input type="radio"/>
J59	P (Gain) 2	0.000 to 30.000 times	<input type="radio"/>	<input type="radio"/>	0.100	<input type="radio"/>	<input type="radio"/>	<input type="radio"/>
J60	I (Integral time) 2	0.0 to 3600.0 s	<input type="radio"/>	<input type="radio"/>	0.0	<input type="radio"/>	<input type="radio"/>	<input type="radio"/>
J61	D (Differential time) 3	0.00 to 600.00 s	<input type="radio"/>	<input type="radio"/>	0.00	<input type="radio"/>	<input type="radio"/>	<input type="radio"/>
J62	(PID control block selection)	0 to 3 bit 0: PID output polarity 0 : Plus (add), 1: Minus (subtract) bit 1: Select compensation factor for PID output 0 = Ratio (relative to the main setting) 1 = Speed command (relative to maximum frequency)	None	<input type="radio"/>	0	<input type="radio"/>	<input type="radio"/>	<input type="radio"/>
J68	Braking Signal (Brake-OFF current)	0% to 300%	<input type="radio"/>	<input type="radio"/>	100	<input type="radio"/>	<input type="radio"/>	<input type="radio"/>
J69	(Brake-OFF frequency/speed)	0.0 to 25.0 Hz	<input type="radio"/>	<input type="radio"/>	1.0	<input type="radio"/>	<input type="radio"/>	<input type="radio"/>
J70	(Brake-OFF timer)	0.0 to 5.0 s	<input type="radio"/>	<input type="radio"/>	1.0	<input type="radio"/>	<input type="radio"/>	<input type="radio"/>
J71	(Brake-ON frequency/speed)	0.0 to 25.0 Hz	<input type="radio"/>	<input type="radio"/>	1.0	<input type="radio"/>	<input type="radio"/>	<input type="radio"/>
J72	(Brake-ON timer)	0.0 to 5.0 s	<input type="radio"/>	<input type="radio"/>	1.0	<input type="radio"/>	<input type="radio"/>	<input type="radio"/>
J95	(Brake-OFF torque)	0% to 300%	<input type="radio"/>	<input type="radio"/>	100	<input type="radio"/>	<input type="radio"/>	<input type="radio"/>
J96	(Speed selection)	0 : Detected speed 1 : Commanded speed	<input type="radio"/>	<input type="radio"/>	0	<input type="radio"/>	<input type="radio"/>	<input type="radio"/>
J97	Servo-lock (Gain)	0.00 to 10.00	<input type="radio"/>	<input type="radio"/>	0.10	None	None	<input type="radio"/>
J98	(Completion timer)	0.000 to 1.000	<input type="radio"/>	<input type="radio"/>	0.100	None	None	<input type="radio"/>
J99	(Completion width)	0 to 9999	<input type="radio"/>	<input type="radio"/>	10	None	None	<input type="radio"/>

\*7 The motor constant is automatically set, depending upon the inverter's capacity and shipping destination.

\*9 These function codes are reserved for particular manufacturers. Unless otherwise specified, do not access these function codes.

<Data change, reflection and strage>

[None]: Not available  : After changing data with using / keys, execute and save data by pressing key,

: After changing and executing data with using / keys, save the data by pressing key.

### Data copy

<input type="radio"/>	Data copy is enabled.
<input type="checkbox"/> 1	Data copy is not enabled if the inverter capacities vary.
<input type="checkbox"/> 2	Data copy is not enabled if the voltage classes vary.
None	Data copy is not enabled.

# Function Settings

## Function Settings

### ●d codes: Application Functions 2

Code	Name	Data setting range	Change when running	Data copying	Default setting	Drive control		
						V/f	W/O PG	W/PG
d01	Speed control 1 (Speed command filter)	0.000 to 5.000 s	<input type="radio"/>	<input type="radio"/>	0.020	None	<input type="radio"/>	<input type="radio"/>
d02	(Speed detection filter)	0.000 to 0.100 s	<input checked="" type="radio"/>	<input type="radio"/>	0.005	None	<input type="radio"/>	<input type="radio"/>
d03	P (Gain)	0.1 to 200.0 times	<input checked="" type="radio"/>	<input type="radio"/>	10.0	None	<input type="radio"/>	<input type="radio"/>
d04	I (Integral time)	0.001 to 1.000 s	<input checked="" type="radio"/>	<input type="radio"/>	0.100	None	<input type="radio"/>	<input type="radio"/>
d05	(Output filter)	0.000 to 0.100 s	<input type="radio"/>	<input type="radio"/>	0.002	None	<input type="radio"/>	<input type="radio"/>
d09	Speed control (Jogging) (Speed command filter)	0.000 to 5.000 s	<input type="radio"/>	<input type="radio"/>	0.020	None	<input type="radio"/>	<input type="radio"/>
d10	(Speed detection filter)	0.000 to 0.100 s	<input checked="" type="radio"/>	<input type="radio"/>	0.005	None	<input type="radio"/>	<input type="radio"/>
d11	P (Gain)	0.1 to 200.0 times	<input checked="" type="radio"/>	<input type="radio"/>	10.0	None	<input type="radio"/>	<input type="radio"/>
d12	I (Integral time)	0.001 to 1.000 s	<input checked="" type="radio"/>	<input type="radio"/>	0.100	None	<input type="radio"/>	<input type="radio"/>
d13	(Output filter)	0.000 to 0.100 s	<input type="radio"/>	<input type="radio"/>	0.002	None	<input type="radio"/>	<input type="radio"/>
d14	Feedback Input (Pulse input property)	0 : Pulse train sign/Pulse train input 1 : Forward rotation pulse/Reverse rotation pulse 2 : A/B phase with 90 degree phase shift	None	<input type="radio"/>	2	None	None	<input type="radio"/>
d15	(Encoder pulse resolution)	0014 to EA60 (hex.) (20 to 60000 pulses)	None	<input type="radio"/>	0400(1024)	None	None	<input type="radio"/>
d16	(Pulse count factor 1)	1 to 9999	None	<input type="radio"/>	1	None	None	<input type="radio"/>
d17	(Pulse count factor 2)	1 to 9999	None	<input type="radio"/>	1	None	None	<input type="radio"/>
d21	Speed Agreement/PG Error (Hysteresis width)	0.0% to 50.0%	<input type="radio"/>	<input type="radio"/>	10.0	None	<input type="radio"/>	<input type="radio"/>
d22	(Detection timer)	0.00 to 10.00 s	<input type="radio"/>	<input type="radio"/>	0.50	None	<input type="radio"/>	<input type="radio"/>
d23	PG Error Processing	0 : Continue to run 1 : Stop running with alarm 1 2 : Stop running with alarm 2	None	<input type="radio"/>	2	None	<input type="radio"/>	<input type="radio"/>
d24	Zero Speed Control	0 : Not permit at startup 1 : Permit at startup	None	<input type="radio"/>	0	None	<input type="radio"/>	<input type="radio"/>
d25	ASR Switching Time	0.000 to 1.000 s	<input type="radio"/>	<input type="radio"/>	0.000	None	<input type="radio"/>	<input type="radio"/>
d32	Torque control (Speed limit 1)	0 to 110%	<input type="radio"/>	<input type="radio"/>	100	None	<input type="radio"/>	<input type="radio"/>
d33	(Speed limit 2)	0 to 110%	<input type="radio"/>	<input type="radio"/>	100	None	<input type="radio"/>	<input type="radio"/>
d51	Reserved *9	0 to 500	None	<input type="radio"/>	*12	—	—	—
d52	Reserved *9	0 to 500	None	<input type="radio"/>	*12	—	—	—
d53	Reserved *9	0 to 500	None	<input type="radio"/>	*12	—	—	—
d54	Reserved *9	0 to 500	None	<input type="radio"/>	*12	—	—	—
d55	Reserved *9	0: Enable factorization 1: Disable factorization	None	<input type="radio"/>	0	—	—	—
d59	Command(Pulse Rate Input) (Pulse input property)	0: Pulse train sign/Pulse train input 1: Forward rotation pulse/Reverse rotation pulse 2: A/B phase with 90 degree phase shift	None	<input type="radio"/>	0	<input type="radio"/>	<input type="radio"/>	<input type="radio"/>
d61	(Filter time constant)	0.000 to 5.000 s	<input type="radio"/>	<input type="radio"/>	0.005	<input type="radio"/>	<input type="radio"/>	<input type="radio"/>
d62	(Pulse count factor 1)	1 to 9999	None	<input type="radio"/>	1	<input type="radio"/>	<input type="radio"/>	<input type="radio"/>
d63	(Pulse count factor 2)	1 to 9999	None	<input type="radio"/>	1	<input type="radio"/>	<input type="radio"/>	<input type="radio"/>
d67	Starting Mode(Auto search)	0: Disable 1: Enable (At restart after momentary power failure) 2: Enable (At restart after momentary power failure and at normal start)	None	<input type="radio"/>	2	None	<input type="radio"/>	None
d68	Reserved *9	0.0 to 10.0 Hz	None	<input type="radio"/>	40	—	—	—
d99	Reserved *9	0 to 7	<input type="radio"/>	<input type="radio"/>	0	—	—	—

● y codes: LINK Functions

Code	Name	Data setting range	Change when running	Data copying	Default setting	Drive control		
						V/f	W/O PG	W/PG
<del>401</del> 402	RS-485 Communication 1 (Station address) (Communications error processing)	1 to 255 0 : Immediately trip with alarm <i>E-rB</i> 1 : Trip with alarm <i>E-rB</i> after running for the period specified by timer y03 2 : Retry during the period specified by timer y03. If the retry fails, trip with alarm <i>E-rB</i> . If it succeeds, continue to run. 3 : Continue to run	None	<input type="radio"/>	1	<input type="radio"/>	<input type="radio"/>	<input type="radio"/>
<del>403</del> 404	(Timer) (Baud rate)	0.0 to 60.0 s 0 : 2400 bps 1 : 4800 bps 2 : 9600 bps 3 : 19200 bps 4 : 38400 bps	<input type="radio"/>	<input type="radio"/>	2.0	<input type="radio"/>	<input type="radio"/>	<input type="radio"/>
<del>405</del> 406	(Data length) (Parity bits check)	0 : 8 bits 1 : 7 bits 0 : None (2 stop bits) 1 : Even parity (1 stop bit) 2 : Odd parity (1 stop bit) 3 : None (1 stop bit)	<input type="radio"/>	<input type="radio"/>	0	<input type="radio"/>	<input type="radio"/>	<input type="radio"/>
<del>407</del> 408	(Stop bits) (No-response error detection time)	0 : 2 bits 1 : 1 bit 0 : No detection; 1 to 60 s	<input type="radio"/>	<input type="radio"/>	0	<input type="radio"/>	<input type="radio"/>	<input type="radio"/>
<del>409</del> 410	(Response interval) (Protocol selection)	0.00 to 1.00 s 0 : Modbus RTU protocol 1 : FRENIC Loader protocol (SX protocol) 2 : Fuji general-purpose inverter protocol	<input type="radio"/>	<input type="radio"/>	0.01	<input type="radio"/>	<input type="radio"/>	<input type="radio"/>
<del>411</del> 412	RS-485 Communication 2 (Station address) (Communications error processing)	1 to 255 0 : Immediately trip with alarm <i>E-rP</i> 1 : Trip with alarm <i>E-rP</i> after running for the period specified by timer y13 2 : Retry during the period specified by timer y13. If the retry fails, trip with alarm <i>E-rP</i> . If it succeeds, continue to run. 3 : Continue to run	None	<input type="radio"/>	1	<input type="radio"/>	<input type="radio"/>	<input type="radio"/>
<del>413</del> 414	(Timer) (Baud rate)	0.0 to 60.0 s 0 : 2400 bps 1 : 4800 bps 2 : 9600 bps 3 : 19200 bps 4 : 38400 bps	<input type="radio"/>	<input type="radio"/>	2.0	<input type="radio"/>	<input type="radio"/>	<input type="radio"/>
<del>415</del> 416	(Data length) (Parity check)	0 : 8 bits 1 : 7 bits 0 : None (2 stop bits) 1 : Even parity (1 stop bit) 2 : Odd parity (1 stop bit) 3 : None (1 stop bit)	<input type="radio"/>	<input type="radio"/>	0	<input type="radio"/>	<input type="radio"/>	<input type="radio"/>
<del>417</del> 418	(Stop bits) (No-response error detection time)	0 : 2 bits 1 : 1 bit 0 : No detection; 1 to 60 s	<input type="radio"/>	<input type="radio"/>	0	<input type="radio"/>	<input type="radio"/>	<input type="radio"/>
<del>419</del> 420	(Response interval) (Protocol selection)	0.00 to 1.00 s 0 : Modbus RTU protocol 2 : Fuji general-purpose inverter protocol	<input type="radio"/>	<input type="radio"/>	0.01	<input type="radio"/>	<input type="radio"/>	<input type="radio"/>
<del>497</del> 498	Communication Data Storage Selection Bus Link Function (Mode selection)	0 : Save into nonvolatile storage (Rewritable times limited) 1 : Write into temporary storage (Rewritable times unlimited) 2 : Save all data from temporary storage to nonvolatile one (After saving data, the data automatically returns to "1.") Frequency command      Run command 0 : Follow H30 data      Follow H30 data 1 : Via fieldbus option      Follow H30 data 2 : Follow H30 data      Via fieldbus option 3 : Via fieldbus option      Via fieldbus option	<input type="radio"/>	<input type="radio"/>	0	<input type="radio"/>	<input type="radio"/>	<input type="radio"/>
<del>499</del> 499	Loader Link Function (Mode selection)	Frequency command      Run command 0 : Follow H30 and y98 data      Follow H30 and y98 data 1 : Via RS-485 link (FRENIC Loader)      Follow H30 and y98 data 2 : Follow H30 and y98 data      Via RS-485 link (FRENIC Loader) 3 : Via RS-485 link (FRENIC Loader)      Via RS-485 link (FRENIC Loader)	<input type="radio"/>	None	0	<input type="radio"/>	<input type="radio"/>	<input type="radio"/>

\*9 These function codes are reserved for particular manufacturers. Unless otherwise specified, do not access these function codes.

\*12 The factory default differs depending upon the inverter's capacity.

5 for inverters with a capacity of 3.7 kW (4.0 kW for the EU) or below; 10 for those with 5.5 kW to 22 kW; 20 for those with 30 kW or above

<Data change, reflection and strage>

None: Not available  : After changing data with using  keys, execute and save data by pressing  key,

After changing and executing data with using  keys, save the data by pressing  key.

Data copy

<input type="radio"/>	Data copy is enabled.
<input type="radio"/> 1	Data copy is not enabled if the inverter capacities vary.
<input type="radio"/> 2	Data copy is not enabled if the voltage classes vary.
None	Data copy is not enabled.

Characteristics  
Model Variations  
Keypad Operations  
Inverter Support Load  
Standard Specifications  
Common Specifications  
Basic Wiring Diagram  
Terminal Functions  
Function Settings  
External Dimensions  
Options  
Warranty  
Variations

# External Dimensions (EMC Filter Built-in Type, Without EMC filter)

## ● Inverter main body

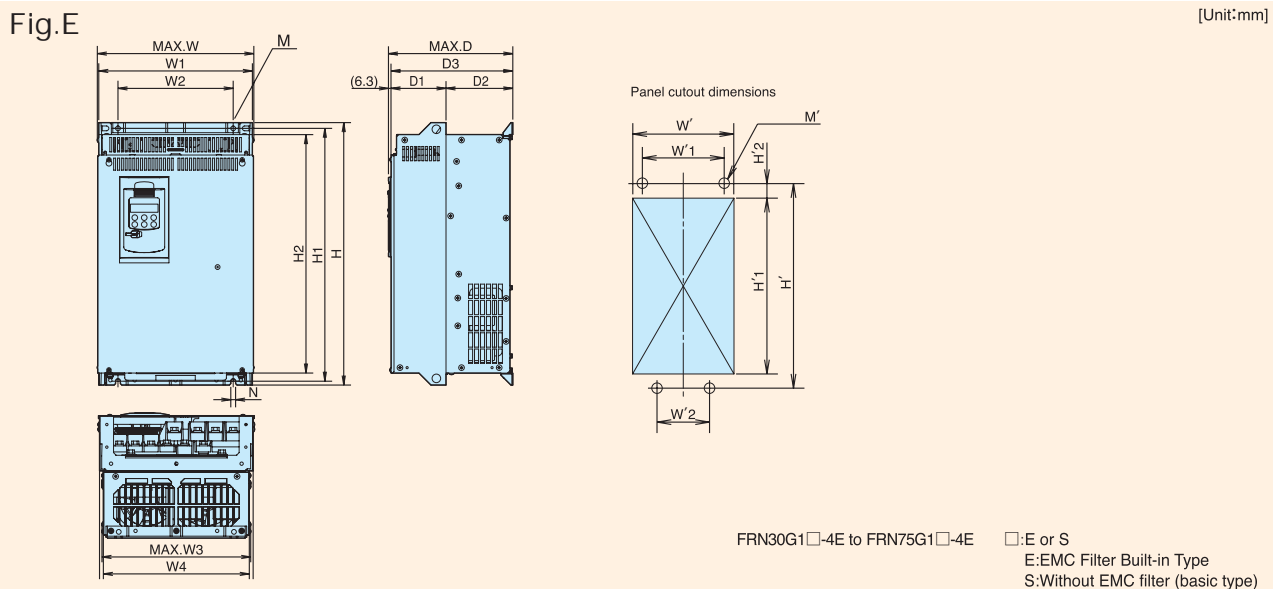
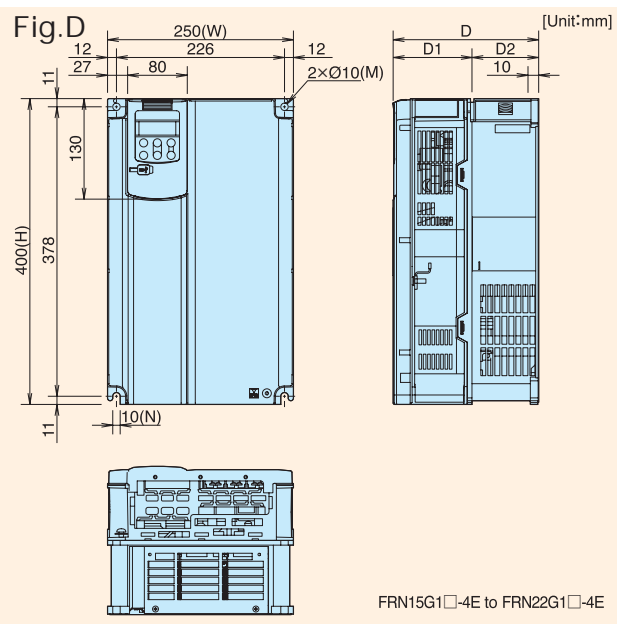
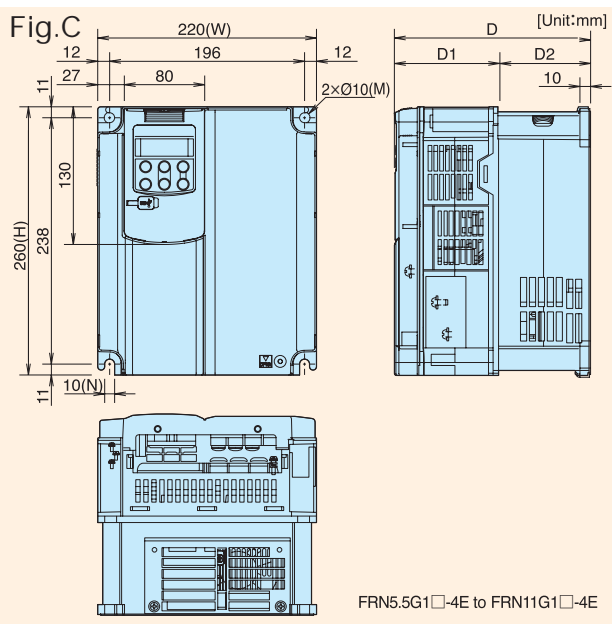
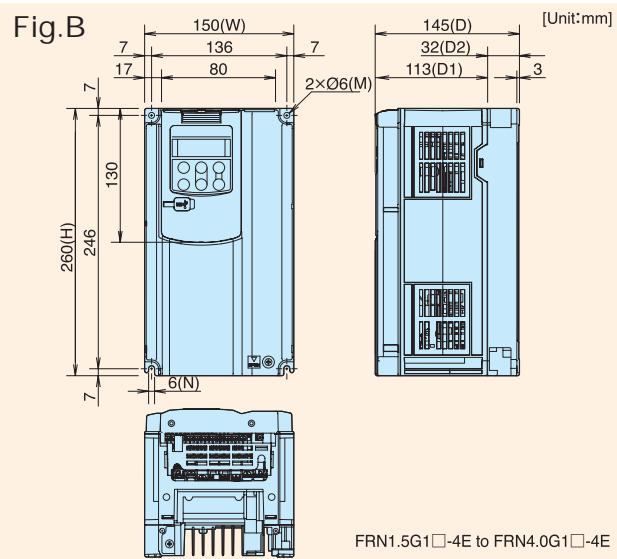
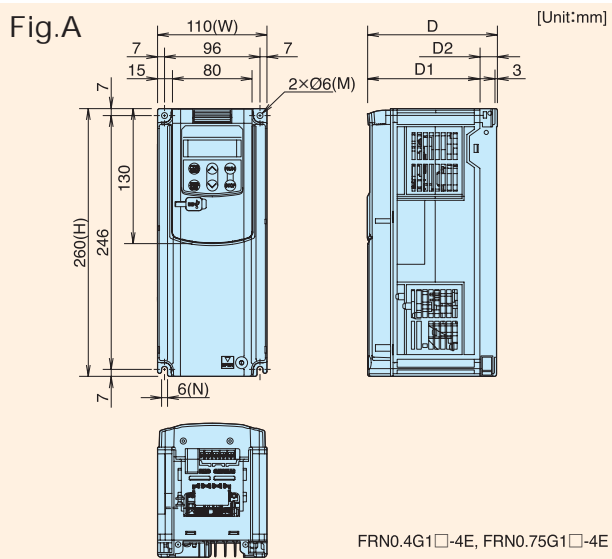





# Options

## DC REACTOR



Fig.A

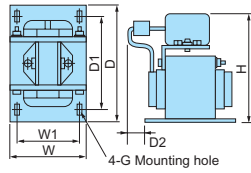

Fig.B

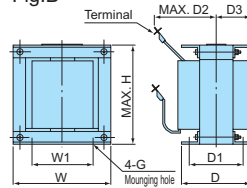
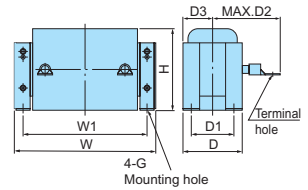

Fig.C



\* Equipped as standard for models of 75kW or higher motor (supplied outside the unit).

Reactor	Fig.	Dimension [mm]									Mass [kg]
		W	W1	D	D1	D2	D3	H	Mounting hole	Terminal hole	
DCR4-0.4	A	66	56	90	72	15	—	94	5.2 x 8	M4	1.0
DCR4-0.75	A	66	56	90	72	20	—	94	5.2 x 8	M4	1.4
DCR4-1.5	A	66	56	90	72	20	—	94	5.2 x 8	M4	1.6
DCR4-2.2	A	86	71	100	80	15	—	110	6 x 9	M4	2
DCR4-3.7	A	86	71	100	80	20	—	110	6 x 9	M4	2.6
DCR4-5.5	A	86	71	100	80	20	—	110	6 x 9	M4	2.6
DCR4-7.5	A	111	95	100	80	24	—	130	7 x 11	M5	4.2
DCR4-11	A	111	95	100	80	24	—	130	7 x 11	M5	4.3
DCR4-15	A	146	124	120	96	15	—	171	7 x 11	M5	5.9
DCR4-18.5	A	146	124	120	96	25	—	171	7 x 11	M6	7.2
DCR4-22A	A	146	124	120	96	25	—	171	7 x 11	M6	7.2
DCR4-30B	B	152±3	90±1	157±3	115±2	100	78±5	130	8	M8	13
DCR4-37C	C	210±10	185	101±2	81±1	105	50.5±1	125	M6	M8	7.4
DCR4-45C	C	210±10	185	106±2	86±1	120	53±1	125	M6	M8	8.4
DCR4-55C	C	255±10	225	96±2	76±1	120	48±1	145	M6	M10	10.3
DCR4-75C	C	255±10	225	106±2	86±1	125	53±1	145	M6	M10	12.4
DCR4-90C	C	256±10	225	116±2	96±1	130	58±1	145	M6	M12	
DCR4-110C	C	306±10	265	116±4	90±2	140	58±2	155	M8	M12	
DCR4-132C	C	306±10	265	126±4	100±2	150	63±2	160	M8	M12	
DCR4-160C	C	357±10	310	131±4	103±2	160	65.5±2	190	M10	M12	
DCR4-200C	C	357±10	310	141±4	113±2	165	70.5±2	190	M10	M12	
DCR4-220C	C	357±10	310	146±4	118±2	185	73±2	190	M10	M12	

\* Equipped as standard for models in boxes (supplied outside the unit).

Inverter type	Reactor			Overload capability, other		
	HD mode	MD mode	LD mode	HD mode	MD mode	LD mode
FRN0.4G1S-4*	DCR4-0.4			150% 1min. 200% 3s		120% 1min.
FRN0.75G1S-4*	DCR4-0.75					
FRN1.5G1S-4*	DCR4-1.5					
FRN2.2G1S-4*	DCR4-2.2			fc:10kHzmax fo:500Hzmax	fc:2kHzmax fo:120Hzmax	fc:5kHzmax fo:120Hzmax
FRN3.7G1S-4*	DCR4-3.7					
FRN5.5G1S-4*	DCR4-5.5		DCR4-7.5			
FRN7.5G1S-4*	DCR4-7.5		DCR4-11	V/F PG Vector W/O PG Vector	V/F PG Vector	V/F PG Vector W/O PG Vector
FRN11G1S-4*	DCR4-11		DCR4-15			
FRN15G1S-4*	DCR4-15		DCR4-18.5			
FRN18.5G1S-4*	DCR4-18.5		DCR4-22A			
FRN22G1S-4*	DCR4-22A		DCR4-30C			
FRN30G1S-4*	DCR4-30C		DCR4-37C			
FRN37G1S-4*	DCR4-37C		DCR4-45C			
FRN45G1S-4*	DCR4-45C		DCR4-55C			
FRN55G1S-4*	DCR4-55C		DCR4-75C			
FRN75G1S-4*	DCR4-75C		DCR4-90C			
FRN90G1S-4*	DCR4-90C	DCR4-110C	DCR4-110C			
FRN110G1S-4*	DCR4-110C	DCR4-132C	DCR4-132C			
FRN132G1S-4*	DCR4-132C	DCR4-160C	DCR4-160C			
FRN160G1S-4*	DCR4-160C	DCR4-200C	DCR4-200C			
FRN200G1S-4*	DCR4-200C	DCR4-220C	DCR4-220C			
FRN220G1S-4*	DCR4-220C	DCR4-250C	DCR4-280C			

## Braking unit and braking resistor (standard item)

HD mode

Power supply voltage	Nominal applied motor (kW)	Inverter type	Option								
			Braking unit		Braking resistor						
			Type	Q'ty	Type	Q'ty					
Three-phase 400V	0.4	FRN0.4G1□-4E	-			DB0.75-4	1				
	0.75	FRN0.75G1□-4E									
	1.5	FRN1.5G1□-4E									
	2.2	FRN2.2G1□-4E						DB2.2-4	1		
	3.7	FRN3.7G1□-4E									
	5.5	FRN5.5G1□-4E									
	7.5	FRN7.5G1□-4E						DB3.7-4	1		
	11	FRN11G1□-4E									
	15	FRN15G1□-4E									
	18.5	FRN18.5G1□-4E						DB5.5-4	1		
	22	FRN22G1□-4E									
	30	FRN30G1□-4E									
	37	FRN37G1□-4E						BU37-4C	1	DB30-4C	1
	45	FRN45G1□-4E									
	55	FRN55G1□-4E									
	75	FRN75G1□-4E						BU55-4C	1	DB37-4C	1
	90	FRN90G1□-4E									
	110	FRN110G1□-4E									
	132	FRN132G1□-4E						BU90-4C	1	DB45-4C	1
	160	FRN160G1□-4E									
	200	FRN200G1□-4E									
	220	FRN220G1□-4E						BU90-4C	1	DB55-4C	1
	280	FRN280G1□-4E									
	315	FRN315G1□-4E									
	355	FRN355G1□-4E						-			
	400	FRN400G1□-4E									
	500	FRN500G1□-4E									
	630	FRN630G1□-4E						-			

Note: □ in the inverter type column represents an alphabetic character.  
□ S (standard)

LD mode

Power supply voltage	Nominal applied motor (kW)	Inverter type	Option								
			Braking unit		Braking resistor						
			Type	Q'ty	Type	Q'ty					
Three-phase 400V	7.5	FRN5.5G1□-4E	-								
	11	FRN7.5G1□-4E									
	15	FRN11G1□-4E						-			
	18.5	FRN15G1□-4E									
	22	FRN18.5G1□-4E									
	30	FRN22G1□-4E						BU37-4C	1	DB30-4C	1
	37	FRN30G1□-4E									
	45	FRN37G1□-4E									
	55	FRN45G1□-4E						BU55-4C	1	DB37-4C	1
	75	FRN55G1□-4E									
	90	FRN75G1□-4E									
	110	FRN90G1□-4E						BU90-4C	1	DB45-4C	1
	132	FRN110G1□-4E									
	160	FRN132G1□-4E									
	200	FRN160G1□-4E						-			
	220	FRN200G1□-4E									
	280	FRN220G1□-4E									
	355	FRN280G1□-4E						-			
	400	FRN315G1□-4E									
	450	FRN355G1□-4E									
	500	FRN400G1□-4E						-			
630	FRN500G1□-4E										
710	FRN630G1□-4E										

Being planned

## Other options

Parts name	Type	Remarks
Extension cable	CB-5S	5m
	CB-3S	3m
	CB-1S	1m
DeviceNet card	OPC-G1-DEV	
CC-link card	OPC-G1-CCL	
PROFIBUS DP card	OPC-G1-PDP	
CANopen	OPC-G1-COP	The CANopen is the card which supports various open bus types. With this card, the following operations can be performed using PC or PLC. - Operation frequency setting - Operation command setting (FWD, REV, RET, etc.) - Data code setting for each function code - Reading trip data
T-link interface card	OPC-G1-TL	Up to 12 inverters can be connected by connecting the Fuji's PLC and the inverter via T-link (I/O transmission). - Operation frequency setting - Operation command setting (FWD, REV, RET, etc.)
PG interface card (supporting 12V)	OPC-G1-PG	Having this card built-in to the inverter allows the speed control and the position control.
PG interface card (supporting 5V)	OPC-G1-PG2	Having this card built-in to the inverter allows the speed control and the position control.
Digital input interface card	OPC-G1-DI	Using this card allows frequency setting by 8, 12, 15, and 16 bits, and by BCD code.
Digital output interface card	OPC-G1-DO	The output interface card to be equipped with FRENIC-MEGA, which allows monitoring frequency, output voltage, and output current with binary code.
Analog input/output interface card	OPC-G1-AIO	Using this card allows the torque limit value input, frequency and frequency ratio setting with analog input.
Relay communication card	OPC-G1-RY	Using this card allows relay output of the inverter general output signal (transistor output).
IP40 supporting attachment	P40G1-□□	Note: These options have restrictions on use as follows. - Ambient temperature: -10 to +40°C - The number of the optional printed circuit boards to be mounted is one. - These options cannot apply to the EMC filter built-in type.

□: 0.75, 3.7, 11, 22.

0.75~0.4, 0.75kW 11~5.5, 7.5, 11kW  
3.7~1.5, 2.2, 3.7kW 22~15, 18.5, 22kW

Restrictions on mounting an optional card

○: Mounting possible None: Mounting impossible

Mounting port	OPC-G1S-□□						
	PG	PG2	SY	DI	DO	AIO	RY
C PORT	○	○	○	○	○	○	None
B PORT	None	None	None	○	○	○	○
A PORT	None	None	None	○	○	○	○
Remarks	※1		※2		※2	※2	※3

\*1 Any one of the above can be mounted on only C port.

\*2 Only one card can be mounted on any of A, B, or C ports.

Cards can be mounted on DI, DO, and AIO ports at the same time, however, two identical cards cannot be allowed.

\*3 The cards can be mounted on both A and B ports.

Two RY cards can be mounted at the same time.

The number of RY contact points of a card is two. If three or four points are necessary, prepare two cards.

Note: There are also restrictions on mounting when using the optional communications card. Contact us for details.

Note: When mounting the IP40 option, only one optional card can be mounted. (RY card allows mounting of two cards.)

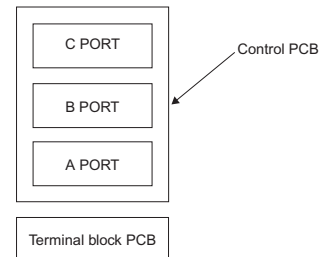

## To all our customers who purchase Fuji Electric FA Components & Systems' products:

Please take the following items into consideration when placing your order.

When requesting an estimate and placing your orders for the products included in these materials, please be aware that any items such as specifications which are not specifically mentioned in the contract, catalog, specifications or other materials will be as mentioned below.

In addition, the products included in these materials are limited in the use they are put to and the place where they can be used, etc., and may require periodic inspection. Please confirm these points with your sales representative or directly with this company.

Furthermore, regarding purchased products and delivered products, we request that you take adequate consideration of the necessity of rapid receiving inspections and of product management and maintenance even before receiving your products.

### 1. Free of Charge Warranty Period and Warranty Range

#### 1-1 Free of charge warranty period

- (1) The product warranty period is "1 year from the date of purchase" or 24 months from the manufacturing date imprinted on the name plate, whichever date is earlier.
- (2) However, in cases where the use environment, conditions of use, use frequency and times used, etc., have an effect on product life, this warranty period may not apply.
- (3) Furthermore, the warranty period for parts restored by Fuji Electric's Service Department is "6 months from the date that repairs are completed."

#### 1-2 Warranty range

- (1) In the event that breakdown occurs during the product's warranty period which is the responsibility of Fuji Electric, Fuji Electric will replace or repair the part of the product that has broken down free of charge at the place where the product was purchased or where it was delivered. However, if the following cases are applicable, the terms of this warranty may not apply.
  - 1) The breakdown was caused by inappropriate conditions, environment, handling or use methods, etc. which are not specified in the catalog, operation manual, specifications or other relevant documents.
  - 2) The breakdown was caused by the product other than the purchased or delivered Fuji's product.
  - 3) The breakdown was caused by the product other than Fuji's product, such as the customer's equipment or software design, etc.
  - 4) Concerning the Fuji's programmable products, the breakdown was caused by a program other than a program supplied by this company, or the results from using such a program.
  - 5) The breakdown was caused by modifications or repairs affected by a party other than Fuji Electric.
  - 6) The breakdown was caused by improper maintenance or replacement using consumables, etc. specified in the operation manual or catalog, etc.
  - 7) The breakdown was caused by a chemical or technical problem that was not foreseen when making practical application of the product at the time it was purchased or delivered.
  - 8) The product was not used in the manner the product was originally intended to be used.
  - 9) The breakdown was caused by a reason which is not this company's responsibility, such as lightning or other disaster.
- (2) Furthermore, the warranty specified herein shall be limited to the purchased or delivered product alone.
- (3) The upper limit for the warranty range shall be as specified in item (1) above and any damages (damage to or loss of machinery or equipment, or lost profits from the same, etc.) consequent to or resulting from breakdown of the purchased or delivered product shall be excluded from coverage by this warranty.

#### 1-3. Trouble diagnosis

As a rule, the customer is requested to carry out a preliminary trouble diagnosis. However, at the customer's request, this company or its service network can perform the trouble diagnosis on a chargeable basis. In this case, the customer is asked to assume the burden for charges levied in accordance with this company's fee schedule.

### 2. Exclusion of Liability for Loss of Opportunity, etc.

Regardless of whether a breakdown occurs during or after the free of charge warranty period, this company shall not be liable for any loss of opportunity, loss of profits, or damages arising from special circumstances, secondary damages, accident compensation to another company, or damages to products other than this company's products, whether foreseen or not by this company, which this company is not be responsible for causing.

### 3. Repair Period after Production Stop, Spare Parts Supply Period (Holding Period)

Concerning models (products) which have gone out of production, this company will perform repairs for a period of 7 years after production stop, counting from the month and year when the production stop occurs. In addition, we will continue to supply the spare parts required for repairs for a period of 7 years, counting from the month and year when the production stop occurs. However, if it is estimated that the life cycle of certain electronic and other parts is short and it will be difficult to procure or produce those parts, there may be cases where it is difficult to provide repairs or supply spare parts even within this 7-year period. For details, please confirm at our company's business office or our service office.

### 4. Transfer Rights

In the case of standard products which do not include settings or adjustments in an application program, the products shall be transported to and transferred to the customer and this company shall not be responsible for local adjustments or trial operation.

### 5. Service Contents

The cost of purchased and delivered products does not include the cost of dispatching engineers or service costs. Depending on the request, these can be discussed separately.

### 6. Applicable Scope of Service

Above contents shall be assumed to apply to transactions and use of the country where you purchased the products. Consult the local supplier or Fuji for the detail separately.

# Variation

## The rich lineup of the active Fuji inverter family

Applications	Series Name (Catalog No.)	Features
General Industrial equipment	<p><b>NEW</b></p> <p><b>FRENIC-MEGA</b> (MEH642 for JE) (MEH655 for EN)</p>	<p><b>High-performance, multi-functional inverter</b> Three-phase 400V: 0.4 to 630kW</p> <ul style="list-style-type: none"> <li>Loaded with vector control which is the peak of general purpose inverters.</li> <li>Prepared three types; the basic type, EMC filter built-in type.</li> <li>Maintainability is further improved with built-in USB port (option).</li> <li>The short-time acceleration and deceleration become enabled with achieving better rating of overload ratings at HD spec: 200% for 3 sec and 150% for 1 min and at LD spec: 120% for 1 min.</li> </ul>
	<p><b>FRENIC5000G11S</b> (MEH403 for JE) (MEH413 for EN)</p>	<p><b>High-performance, multi-functional inverter multi-functional</b> <b>Capacity range expanded</b> (Three-phase 200V: 0.2 to 90kW, Three-phase 400V: 0.4 to 630kW)</p> <ul style="list-style-type: none"> <li>Fuji's original dynamic torque vector control system delivers a starting torque of 200% at 0.5Hz.</li> <li>These inverters are packed with a full range of convenient functions, beginning with an auto tuning function.</li> <li>Compact, fully enclosed (22kW and below).</li> </ul>
	<p><b>FRENIC5000P11S</b> (MEH403)</p>	<p><b>Fan, pump inverter</b> <b>Capacity range expanded</b> (Three-phase 200V: 5.5 to 110kW, Three-phase 400V: 5.5 to 710kW)</p> <ul style="list-style-type: none"> <li>Suitable for fans and pumps.</li> <li>The built-in automatic energy-saving function makes energy saving operation easy.</li> <li>An interactive keypad is standard-equipped for ease of operation.</li> </ul>
	<p><b>FRENIC-Multi</b> (MEH652 for JE) (MEH653 for EN)</p>	<p><b>High performance, compact inverter</b> (Three-phase 200V: 0.1 to 15kW, Single-phase 200V: 0.1 to 2.2kW, Three-phase 400V: 0.4 to 15kW)</p> <ul style="list-style-type: none"> <li>The inverter featuring environment-friendly and long life design (10 years) complies with RoHS Directives (products manufactured beginning in the autumn of 2005).</li> <li>With expanded capacity range, abundant model variation, and simple and thorough maintenance, the Multi is usable for a wide range of applications.</li> <li>Equipped with the functions optimum for the operations specific to vertical and horizontal conveyance, such as hit-and-stop control, brake signal, torque limit, and current limit.</li> </ul>
	<p><b>FRENIC-Eco</b> (MEH442)</p>	<p><b>Fan, pump inverter (for variable torque load)</b> (Three-phase 200V: 0.75 to 110kW, Three-phase 400V: 0.75 to 560kW)</p> <ul style="list-style-type: none"> <li>Developed exclusively for controlling variable torque load like fans and pumps.</li> <li>Full of new functions such as auto energy saving, PID control, life warning, and switching sequence to the commercial power supply.</li> <li>Ideal for air conditioners, fans, pumps, etc. which were difficult to use with conventional general-purpose inverters because of cost or functions.</li> </ul>
	<p><b>FRENIC-Mini</b> (MEH441 for JE) (MEH451 for EN)</p>	<p><b>Compact inverter</b> (Three-phase 200V: 0.1 to 3.7kW, Three-phase 400V: 0.4 to 3.7kW, Single-phase 200V: 0.1 to 2.2kW, Single-phase 100V: 0.1 to 0.75kW)</p> <ul style="list-style-type: none"> <li>A frequency setting device is standard-equipped, making operation simple.</li> <li>Loaded with auto torque boost, current limiting, and slip compensation functions, all of which are ideal for controlling traverse conveyors.</li> <li>Loaded with the functions for auto energy saving operation and PID control, which are ideal for controlling fans and pumps.</li> </ul>
	<p><b>FRENIC5000VG7S</b> (MEH405)</p>	<p><b>High performance, vector control inverter</b> <b>Capacity range expanded</b> (Three-phase 200V: 0.75 to 90kW, Three-phase 400V: 3.7 to 800kW)</p> <ul style="list-style-type: none"> <li>A high precision inverter with rapid control response and stable torque characteristics.</li> <li>Abundant functions and a full range of options make this inverter ideal for a broad range of general industrial systems.</li> <li>The auto tuning function makes vector control operation possible even for general-purpose motors.</li> </ul>



### Safety Precautions

1. Use the contents of this catalog only for selecting product types and models. When using a product, read the Instruction Manual beforehand to use the product correctly.
2. Products introduced in this catalog have not been designed or manufactured for such applications in a system or equipment that will affect human bodies or lives. Customers, who want to use the products introduced in this catalog for special systems or devices such as for atomic-energy control, aerospace use, medical use, and traffic control, are requested to consult the Fuji's Sales Division. Customers are requested to prepare safety measures when they apply the products introduced in this catalog to such systems or facilities that will affect human lives or cause severe damage to property if the products become faulty.

Characteristics

Model Variations

Keypad Operations

Inverter Support Load

Standard Specifications

Common Specifications

Basic Wiring Diagram

Terminal Functions

Function Settings

External Dimensions

Options

Warranty

Variations

# MEMO

# MEMO



## NOTES

### When running general-purpose motors

- **Driving a 400V general-purpose motor**  
When driving a 400V general-purpose motor with an inverter using extremely long cables, damage to the insulation of the motor may occur. Use an output circuit filter (OFL) if necessary after checking with the motor manufacturer. Fuji's motors do not require the use of output circuit filters because of their reinforced insulation.
- **Torque characteristics and temperature rise**  
When the inverter is used to run a general-purpose motor, the temperature of the motor becomes higher than when it is operated using a commercial power supply. In the low-speed range, the cooling effect will be weakened, so decrease the output torque of the motor. If constant torque is required in the low-speed range, use a Fuji inverter motor or a motor equipped with an externally powered ventilating fan.
- **Vibration**  
When the motor is mounted to a machine, resonance may be caused by the natural frequencies, including that of the machine. Operation of a 2-pole motor at 60Hz or more may cause abnormal vibration.  
\* Study use of tie coupling or dampening rubber.  
\* It is also recommended to use the inverter jump frequency control to avoid resonance points.
- **Noise**  
When an inverter is used with a general-purpose motor, the motor noise level is higher than that with a commercial power supply. To reduce noise, raise carrier frequency of the inverter. High-speed operation at 60Hz or more can also result in more noise.

### When running special motors

- **High-speed motors**  
When driving a high-speed motor while setting the frequency higher than 120Hz, test the combination with another motor to confirm the safety of high-speed motors.
- **Explosion-proof motors**  
When driving an explosion-proof motor with an inverter, use a combination of a motor and an inverter that has been approved in advance.
- **Submersible motors and pumps**  
These motors have a larger rated current than general-purpose motors. Select an inverter whose rated output current is greater than that of the motor.  
These motors differ from general-purpose motors in thermal characteristics. Set a low value in the thermal time constant of the motor when setting the electronic thermal facility.
- **Brake motors**  
For motors equipped with parallel-connected brakes, their braking power must be supplied from the primary circuit (commercial power supply). If the brake power is connected to the inverter power output circuit (secondary circuit) by mistake, problems may occur.  
Do not use inverters for driving motors equipped with series-connected brakes.
- **Geared motors**  
If the power transmission mechanism uses an oil-

lubricated gearbox or speed changer/reducer, then continuous motor operation at low speed may cause poor lubrication. Avoid such operation.

- **Synchronous motors**  
It is necessary to use software suitable for this motor type. Contact Fuji for details.
- **Single-phase motors**  
Single-phase motors are not suitable for inverter-driven variable speed operation. Use three-phase motors.  
\* Even if a single-phase power supply is available, use a three-phase motor as the inverter provides three-phase output.

### Environmental conditions

- **Installation location**  
Use the inverter in a location with an ambient temperature range of -10 to 50°C.  
The inverter and braking resistor surfaces become hot under certain operating conditions. Install the inverter on nonflammable material such as metal. Ensure that the installation location meets the environmental conditions specified in "Environment" in inverter specifications.

### Combination with peripheral devices

- **Installing a molded case circuit breaker (MCCB)**  
Install a recommended molded case circuit breaker (MCCB) or an earth leakage circuit breaker (ELCB) in the primary circuit of each inverter to protect the wiring. Ensure that the circuit breaker capacity is equivalent to or lower than the recommended capacity.
- **Installing a magnetic contactor (MC) in the output (secondary) circuit**  
If a magnetic contactor (MC) is mounted in the inverter's secondary circuit for switching the motor to commercial power or for any other purpose, ensure that both the inverter and the motor are fully stopped before you turn the MC on or off. Remove the surge killer integrated with the MC.
- **Installing a magnetic contactor (MC) in the input (primary) circuit**  
Do not turn the magnetic contactor (MC) in the primary circuit on or off more than once an hour as an inverter fault may result. If frequent starts or stops are required during motor operation, use FWD/REV signals.
- **Protecting the motor**  
The electronic thermal facility of the inverter can protect the motor. The operation level and the motor type (general-purpose motor, inverter motor) should be set. For high-speed motors or water-cooled motors, set a small value for the thermal time constant to protect the motor.  
If you connect the motor thermal relay to the motor with a long cable, a high-frequency current may flow into the wiring stray capacitance. This may cause the relay to trip at a current lower than the set value for the thermal relay. If this happens, lower the carrier frequency or use the output circuit filter (OFL).
- **Discontinuance of power-factor correcting capacitor**  
Do not mount power factor correcting capacitors in the inverter (primary) circuit. (Use the DC REACTOR to improve the inverter power factor.) Do

not use power factor correcting capacitors in the inverter output circuit (secondary). An overcurrent trip will occur, disabling motor operation.

- **Discontinuance of surge killer**  
Do not mount surge killers in the inverter output (secondary) circuit.
- **Reducing noise**  
Use of a filter and shielded wires are typical measures against noise to ensure that EMC Directives are met.
- **Measures against surge currents**  
If an overvoltage trip occurs while the inverter is stopped or operated under a light load, it is assumed that the surge current is generated by open/close of the phase-advancing capacitor in the power system.  
We recommend connecting a DC REACTOR to the inverter.
- **Megger test**  
When checking the insulation resistance of the inverter, use a 500V megger and follow the instructions contained in the Instruction Manual.

### Wiring

- **Wiring distance of control circuit**  
When performing remote operation, use the twisted shield wire and limit the distance between the inverter and the control box to 20m.
- **Wiring length between inverter and motor**  
If long wiring is used between the inverter and the motor, the inverter will overheat or trip as a result of overcurrent (high-frequency current flowing into the stray capacitance) in the wires connected to the phases. Ensure that the wiring is shorter than 50m. If this length must be exceeded, lower the carrier frequency or mount an output circuit filter (OFL).
- **Wiring size**  
Select cables with a sufficient capacity by referring to the current value or recommended wire size.
- **Wiring type**  
Do not use multicore cables that are normally used for connecting several inverters and motors.
- **Grounding**  
Securely ground the inverter using the grounding terminal.

### Selecting inverter capacity

- **Driving general-purpose motor**  
Select an inverter according to the applicable motor ratings listed in the standard specifications table for the inverter. When high starting torque is required or quick acceleration or deceleration is required, select an inverter with a capacity one size greater than the standard.
- **Driving special motors**  
Select an inverter that meets the following condition:  
Inverter rated current > Motor rated current.

### Transportation and storage

When transporting or storing inverters, follow the procedures and select locations that meet the environmental conditions that agree with the inverter specifications.

# Fuji Electric FA Components & Systems Co., Ltd.

Mitsui Sumitomo Bank Ningyo-cho Bldg.,  
5-7, Nihonbashi Odemma-cho, Chuo-ku, Tokyo 103-0011, Japan  
Phone: +81-3-5847-8011 Fax: +81-3-5847-8172

Printed on recycled paper

Information in this catalog is subject to change without notice.

Printed in Japan 2008-4 (D08/C08) CM 20 FIS