

arrangement of pins and bushes see page 2 and 3

	All Dimensions in mm Original Size DIN A4		Scale 2:1	Free size tol.		Ref.	
			Created by KLASSEN P	Inspected by BERGHORN	Standardisation TIEMANNA	Sub.	
All rights reserved Department EL PD - DE		Date 2017-01-16		State Final Release			
09 14 000 9909	guide bush	Title Han-Modular Fuehrungstifte				Doc-Key / ECM-Nr. 100175794 / UGD / 003 / D 500000113697	
09 14 000 9908	guide pin						
part number	description	HARTING Electric GmbH & Co. KG D-32339 Espelkamp		Type TB	Number 09 14 000 990X	Rev. D	Page 1/3

coding system with guide pins and bushes

for hoods/housings with one frame or hinged frame

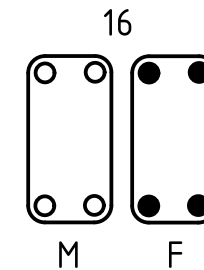
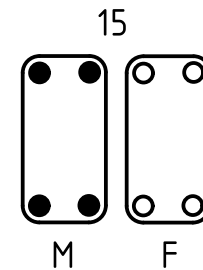
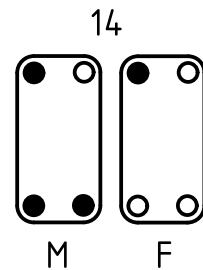
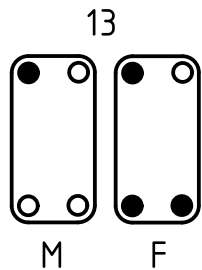
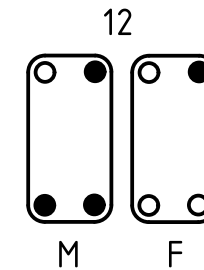
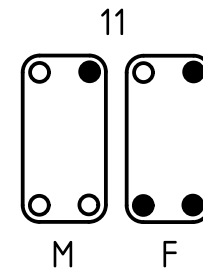
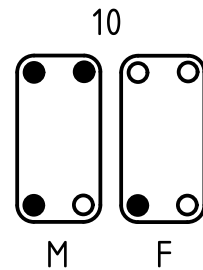
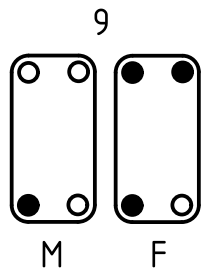
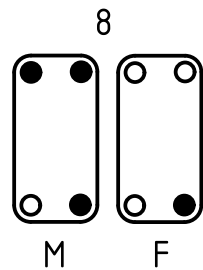
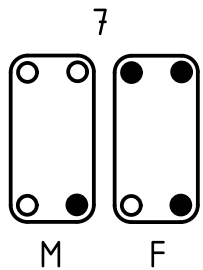
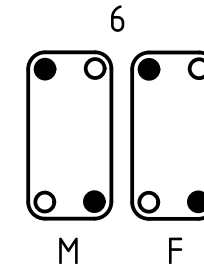
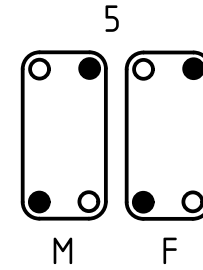
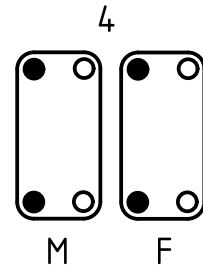
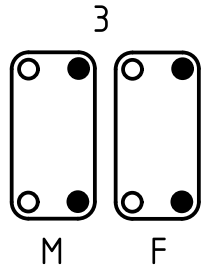
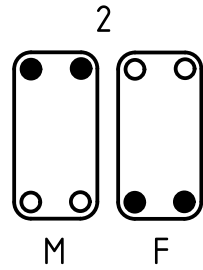
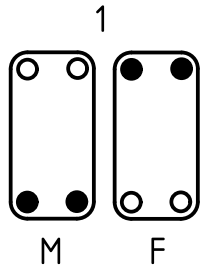

- F - frame or hinged frame for hoods
- M - frame or hinged frame for housings
- - guide pin
- - guide bush

	All rights reserved	Created by	Inspected by	Standardisation	Date	State	
	Department EL PD - DE	KLASSEN P	BERGHORN	TIEMANNA	2017-01-16	Final Release	
HARTING Electric GmbH & Co. KG		Title Han-Modular Fuehrungsstifte				Doc-Key / ECM-Nr. 100175794/UGD/003/D 500000113697	
D-32339 Espelkamp		Type	Number			Rev.	Page
		TB	09 14 000 990X			D	2/3

coding system with code pins

for hoods/housings with two frame or two hinged frame

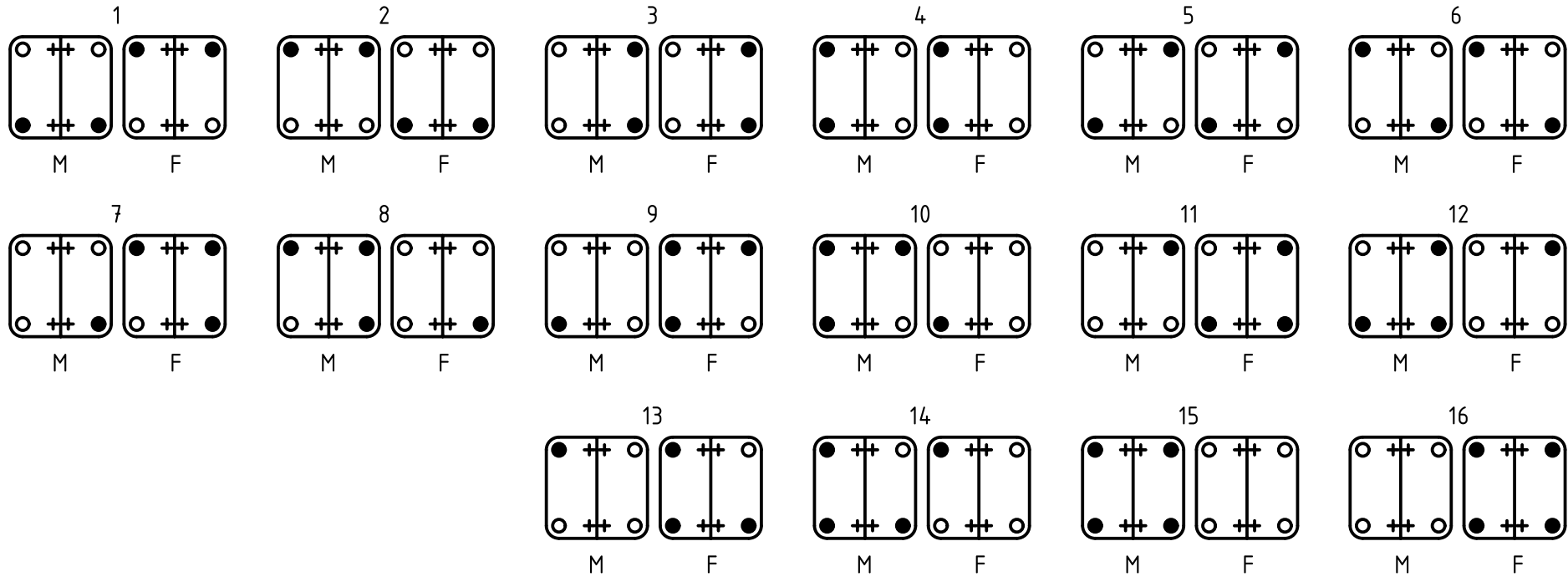

- F - frame or hinged frame for hoods
- M - frame or hinged frame for housings
- - guide pin
- - guide bush
- + - mounting screw

	All rights reserved	Created by	Inspected by	Standardisation	Date	State	
	Department EL PD - DE	KLASSEN P	BERGHORN	TIEMANNA	2017-01-16	Final Release	
HARTING Electric GmbH & Co. KG		Title				Doc-Key / ECM-Nr.	
D-32339 Espelkamp		Han-Modular Fuehrungsstifte				100175794 / UGD / 003 / D 500000113697	
		Type	Number			Rev.	Page
		TB	09 14 000 990X			D	3/3