

1 2 3 4 5 6

A

B

C

D

A-A

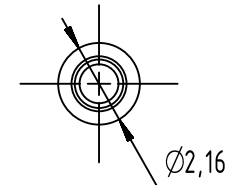
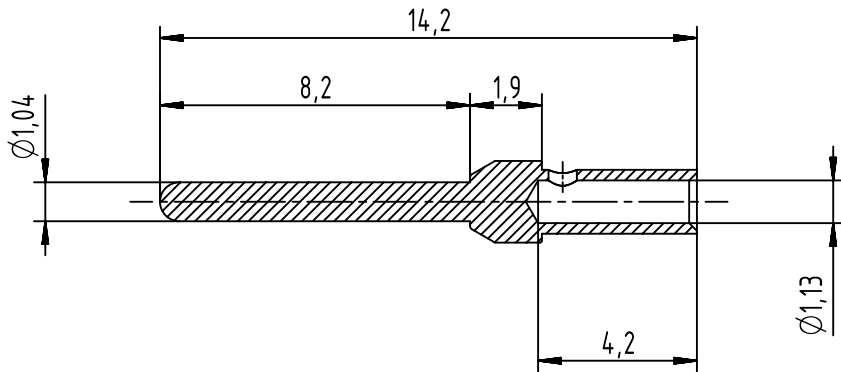



Crimping of AWG 20-24:

hand tool: 09 99 000 0501

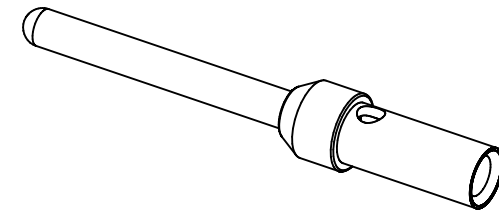
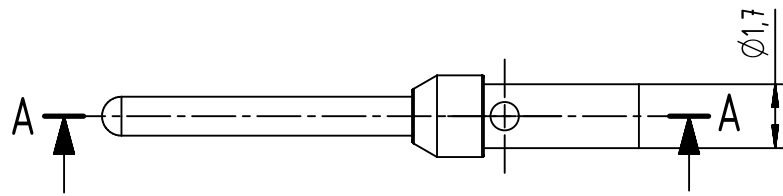
locator: 09 99 000 0531

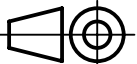

 All Dimensions in mm Original Size DIN A4			Scale 5:1	Free size tol.		Ref.
 All rights reserved Department EC PD - FR			Created by BOURGEOIS	Inspected by BAGDIKIAN	Standardisation KOHLER	Date 2014-06-18
09 67 000 8576 580	PL1	5000	Title D-Sub, MA AWG 20-24 crimp cont			State Final Release
09 67 000 8576	PL1	100	Type TB			Doc-Key / ECM-Nr. 100562538/UGD/001/B 500000076079
Part number	Gold plating (over nickel)	Bulk packaging	Number 09670008576			Rev. <b>B</b> Page 1/1
 HARTING Electronics GmbH D-32339 Espelkamp						