

1 2 3 4 5 6

A

B

C

D

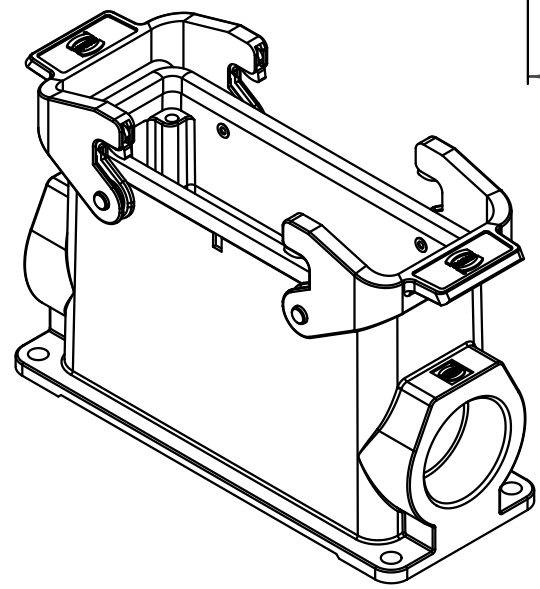
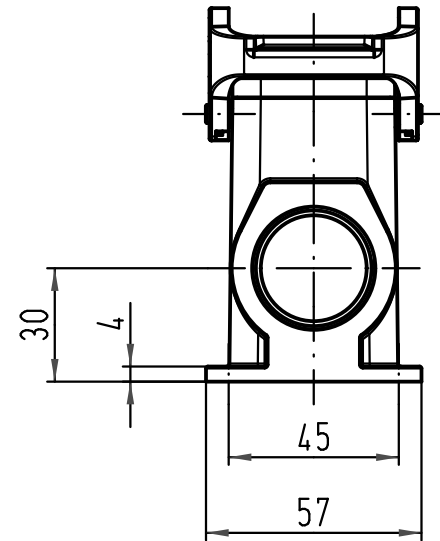
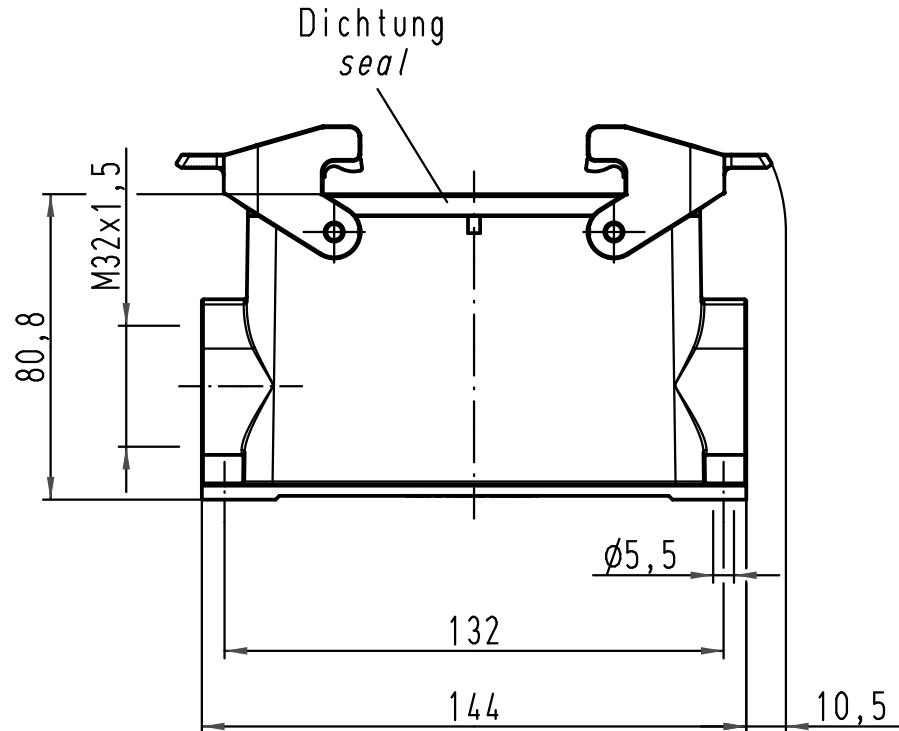

All Dimensions in mm Original Size DIN A 4		Techn. Character.			Nicht tolerierte Maß/Free size tolerances	
			Dat.	Name	Maßstab/Scale 1:2	Han 24B-asg1-QB-M32 Sockelgehäuse housing surface mounting
			Detail.	04.03.11 Spr		
			Insp.	Be		
			Stand.			
A			HARTING Electric GmbH & Co. KG			TB 19 30 024 0232
Mod.	Dat.	Name	D-32339 Espelkamp			
Sub. TB 19 30 024 0232 v. 21.11.00						Blatt/page