

With or without terminals

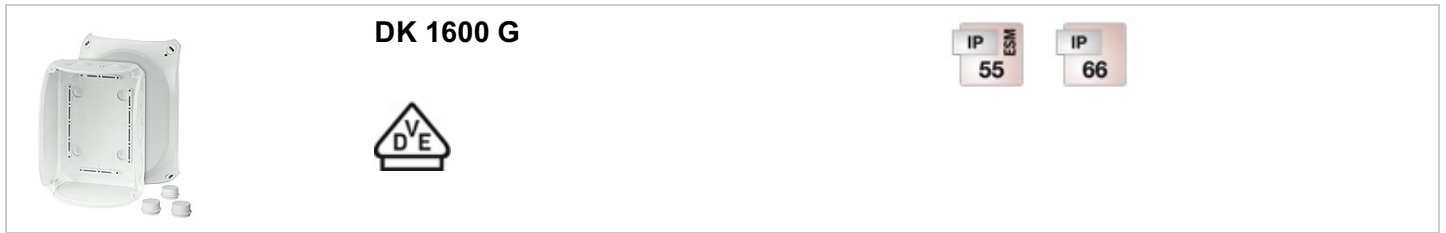

- without terminals
- included cable entry: 3 x ESM 40, sealing range Ø 17-30 mm
- with two cable entries M 32 from the rear side
- lid fasteners sealable without accessories
- external brackets for wall fixing included
- colour: grey, RAL 7035

rated insulation voltage	$U_i = 1000 \text{ V a.c./d.c.}$
material	PC (Polycarbonate)
degree of protection	IP 55 (ESM)
degree of protection	IP 66 (AKM)
mounting width	175 mm
mounting height	120 mm
max. installation depth	76 mm
width	210 mm
height	155 mm
depth	92 mm
weight	0,444 kg
in accordance with	IEC 60670-22

Drawings

Dimension drawing

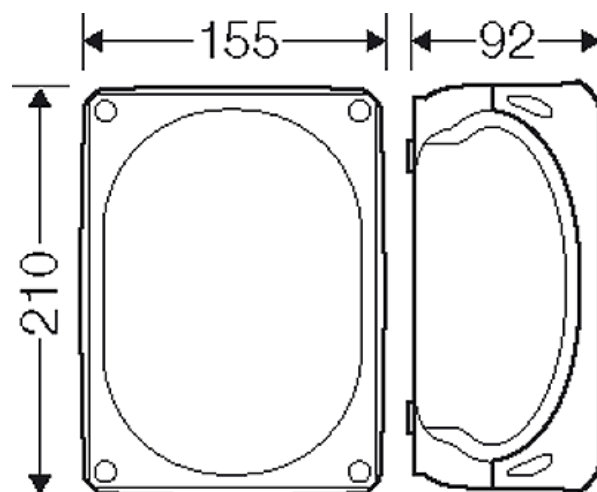

With or without terminals

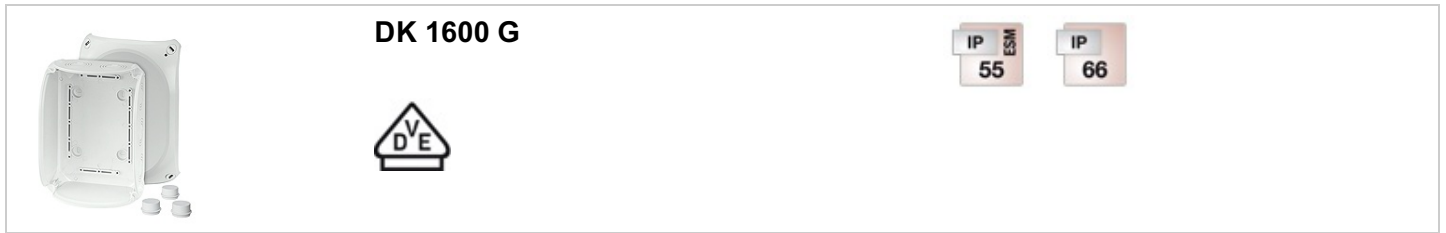

DK 1600 G

IP ESM
55

IP
66



Detail mass

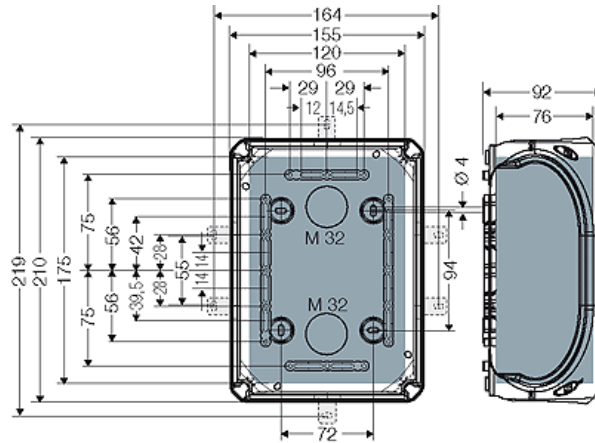

Box walls

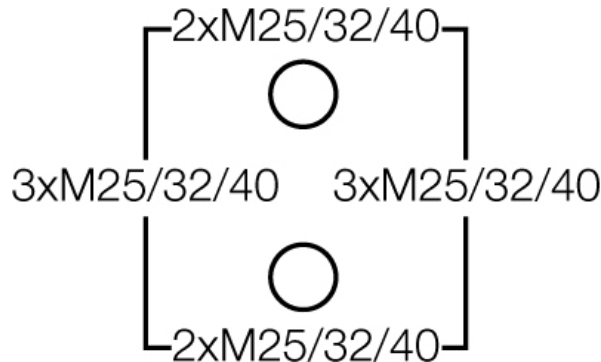

Operating and ambient conditions

Application area	Suitable for indoor installation and outdoor installation, protected against weather influences
Ambient temperature	Maximum value + 40 °C Minimum value - 25 °C
Fire protection in the event of internal faults	Demands placed on electrical devices from standards and laws Minimum requirements - Glow wire test in accordance with IEC 60695-2-11: - 650°C for boxes and cable glands - 850°C for parts of insulating material necessary to retain current carrying parts in position
Burning behaviour	Glow wire test IEC 60695-2-11: 750 °C UL Subject 94: V-2 flame-retardant self-extinguishing
Degree of protection against mechanical load	IK07 (2 Joule)
Toxic behaviour	halogen-free silicone-free "halogen-free" in accordance with the examination of the cables and insulated wires - corrosiveness of fumes - as per IEC 60754-2
Note:	For material properties see technical data.