

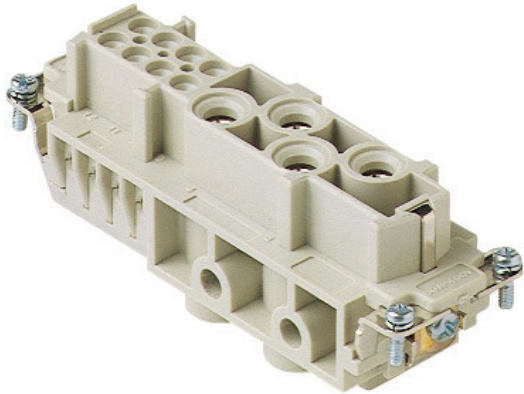

Part number

CXF 4/8



Female insert, CX series, screw terminal connection, 4 + 8 poles + PE, 80 A 400 V 6 kV 3 / 16 A 230/400 V 4 kV 3, size "104.27"

Product description

Product type	Insert
Series	CX
Connection type	Screw terminal connection
Gender	Female
N. of poles	4 poles + 
Auxiliary poles	8 poles
Size	Size "104.27"

Technical data

Current	80 A
Voltage	400 V
Rated impulse withstand voltage	6 kV
Pollution degree	3
Rated voltage according to UL/CSA	600 V
Wire cross-section	4,00 mm ² - 16,00 mm ²
AWG size	12 - 6
Contact type	Turned silver plated
IP degree of protection	IP20 without enclosure, IP65/IP66/IP68/IP69 with enclosure

Further technical details

Characteristics according to EN 61984	80A 400V 6kV 3 (aux:16A 230/400V 4kV 3); 80A 400/690V 6kV 2 (aux:16A 400V 4kV 2)
Mating cycles	≥ 500
Insulation resistance	≥ 10 GΩ
Weight	150,00 g
Operating temperature range (min, max)	-40 °C ... +125 °C
UL 94 flammability rating	V-0

Material properties

Main material	Polycarbonate (PC)
Other materials	Contacts: copper alloy
Colour	RAL 7032 grey
RoHs conformity	Compliant with exemption 6(c): copper alloy containing up to 4% lead by weight
China RoHs - EFUP	50
REACH SVHC substances	Yes Lead
SCIP number	1a9c93ff-0445-4a16-81e3-1609ac5274d6

Approvals / Standards

Reference standard	EN 61984:2009-06
Certifications	CSA, CQC, DNV, BV, EAC
UL	ECBT2
cUL	ECBT8

General ordering information

EAN13 code	8015747042352
eCl@ss 8.1	27440205
ETIM 7.0	EC000438

Packaging Information

Packaging length	245,00 mm
Packaging height	165,00 mm
Packaging width	215,00 mm
Packaging weight	4,89 kg
Packaging volume	8,69 dm ³
Packaging description	Carton box
Packaging quantity	30 Pcs
Packaging EAN code	8015747191852
Sub-packaging length	113,00 mm
Sub-packaging height	36,00 mm
Sub-packaging width	180,00 mm
Sub-packaging weight	0,82 kg
Sub-packaging volume	0,73 dm ³
Sub-packaging description	Carton tray
Sub-packaging quantity	5 Pcs
Sub-packaging EAN barcode	8015747042369

Part number

CXF 4/8



Catalogue drawings

CXM 4/8

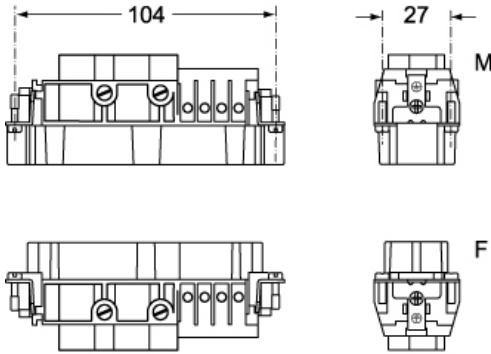

Catalogue drawings

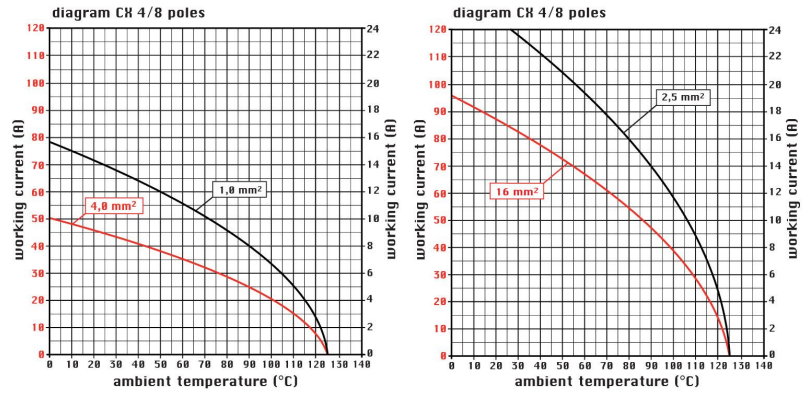

CXF 4/8

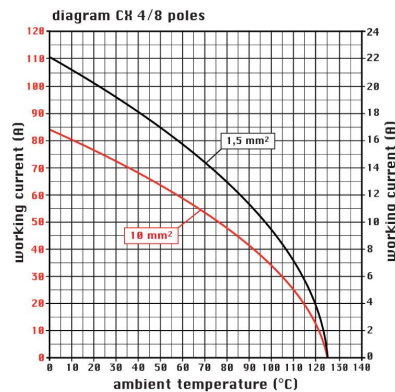
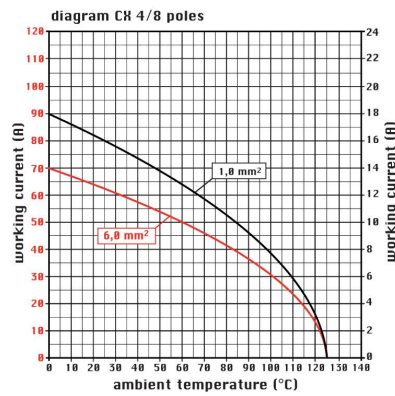
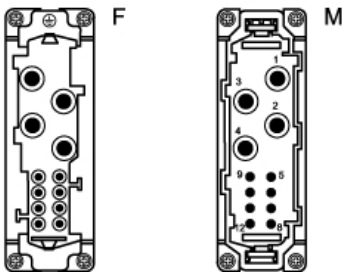

Notes

Dimensions shown in mm are not binding and may be changed without notice.

California Proposition 65 Information



WARNING

This product can expose you to lead and its compounds, known to the State of California to cause cancer and/or reproductive toxicity. For more information go to www.P65Warnings.ca.gov.
