



F 504 without reset button, push-in housing



F 514 with reset button, screw fixture



F 518 without reset button, screw fixture

Electro-mechanical Impulse Meter with / without Reset

Order designations

Standard voltages

A3 24 VDC
A5 24 VAC
A8 110 VAC
A9 230 VAC

Front dimensions 50 x 25 mm To be plugged in and lined up within housing

- F 504.600E** **B** Without reset, 6-digit display
F 504.800F **C** Without reset, 8-digit display
F 504.640D **B** With key reset, 6-digit display
F 504.650D **B** With button reset, 6-digit display

Front dimensions 60 x 37.5 mm Fasten. of fr. plate by means of 2 screws

- F 514.600B** **B** Without reset, 6-digit display
F 514.640A **B** With key reset, 6-digit display
F 514.650A **B** With reset button, 6-digit display

Front dimensions 66.5 x 37 mm Fasten. of fr. plate by means of 2 screws

- F 518.600B** **B** Without reset, 6-digit display
F 518.800C **C** Without reset, 8-digit display
F 518.640A **B** With key reset, 6-digit display
F 518.650A **B** With reset button, 6-digit display

Front dimensions 53.2 x 28.2 mm Fastening by means of clamping

- F 524.600E** **B** Without reset, 6-digit display
F 524.800F **C** Without reset, 8-digit display
F 524.640D **B** With key reset, 6-digit display
F 524.650D **B** With reset button, 6-digit display

Front dimensions 60 x 37.5 mm Fastening by means of clamping spring

- F 544.600B** **B** Without reset, 6-digit display
F 544.640A **B** With key reset, 6-digit display
F 544.650A **B** With reset button, 6-digit display

Front dimensions 60 x 50 mm Fasten. of fr. plate by means of 2 screws

- F 574.600B** **B** Without reset, 6-digit display
F 574.640A **B** With key reset, 6-digit display
F 574.650A **B** With reset button, 6-digit display

F 504, F 514, F 518, **F 524**, F 544, F 574



F 524 with reset button, clamping fixture



F 574 with reset button, screw fixture

Mechanical data

Display	6-digit, 999 999 8-digit, 99 999 999
Digit size	Approx. 4.5 mm high, white on black background
Reset	Manual button or key reset
Counting mode	1 pulse = 1 digit added in 2 half-steps
Housing material	Black plastic
Weight	Approx. 100 g
Life cycle	DC: approx. 10^8 pulses AC: approx. 5×10^7 pulses

Electrical data

	Maximum counting speed	
	20 pulses/s	10 pulses/s
Voltage	24 VDC ± 10 %	24 VAC ± 10 % 110 VAC ± 10 % 230 VAC $+6/-10$ %
Residual ripple / Frequency	≤ 48 %	50...60 Hz
Rating	2 W	3 VA
Min. pulse duration	25 ms	50 ms
Min. pulse interval	25 ms	50 ms
Load factor at 25 °C	100 %	100 %

E-connection	Push-in housing: Solder terminal or terminal contacts on silver-plated tab connectors 0.8 x 2.8 mm Without push-in housing: Contact pins $\varnothing 1.5$ mm, solder terminal on push-on silver-plated contact lugs
--------------	--

Order designations for „H“-connector

Standard voltages

B3	24 VDC	„H“- connector
B5	24 VAC	„H“- connector
B8	110 VAC	„H“- connector
B9	230 VAC	„H“- connector

Front dimensions 50 x 25 mm
To be plug. in a. lined up within hous.

F 504.600E	<input type="checkbox"/> <input type="checkbox"/> B	Without reset, 6-digit display
F 504.800F	<input type="checkbox"/> <input type="checkbox"/> C	Without reset, 8-digit display
F 504.640D	<input type="checkbox"/> <input type="checkbox"/> B	With key reset, 6-digit display
F 504.650D	<input type="checkbox"/> <input type="checkbox"/> B	With button reset, 6-digit display

Ambient conditions

Ambient temperature	0...+45 °C
Storage temperature	-20...+70 °C
Relative humidity	Max. relative humidity 80 %, at 25 °C, non-condensing
Protection	IP 41 for front side per DIN 40050
Operational requirements	To contamination degree 2
Classification	EN 61010, Category II
Interference immunity	EN 50082-2 Severity grade 2 - 3
Emitted interference	EN 50081-2
General rating	EN 61010
Overvoltage protection	II

F 504, F 514, F 518, **F 524**, F 544, F 574

Dimensions and cutout sizes

F 504 with reset button, 6-digit display

Please indicate when placing your order whether counters F 504 are to be mounted together with preselection counters FE504 in a common front frame and/or in counter panels with common mounting rails. The counters F 504 will then be supplied ex works with a suitable, so-called external push-in housing "H".

Cutout 50 x 25 mm

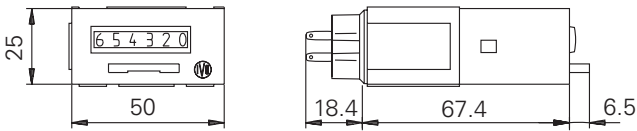

Dimensions and cutout sizes

F 504 without reset, 6-digit und 8-digit display

Cutout 50 x 25 mm

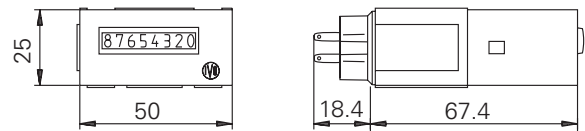

F 514 with reset button, 6-digit display

Cutout 51 x 26 mm

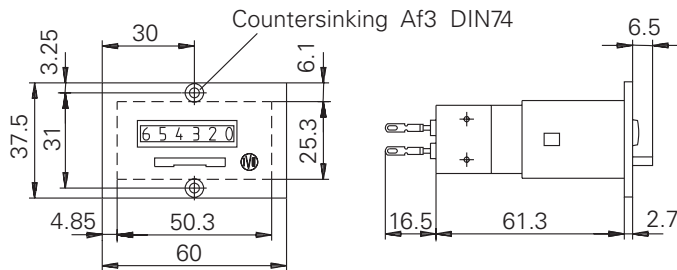

F 514 without reset, 6-digit display

Cutout 51 x 26 mm

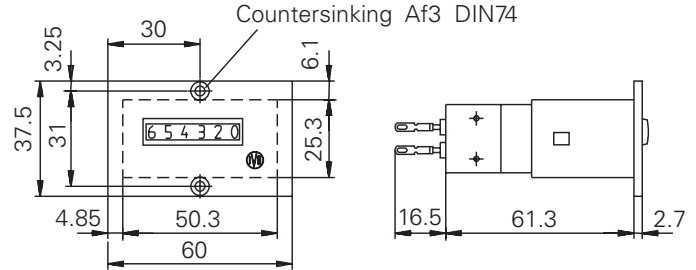

F 518 with reset button, 6-digit display

Cutout 51 x 26 mm

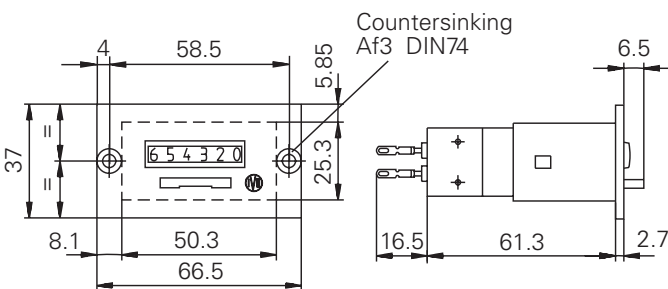

F 518 without reset, 6-digit und 8-digit display

Cutout 51 x 26 mm

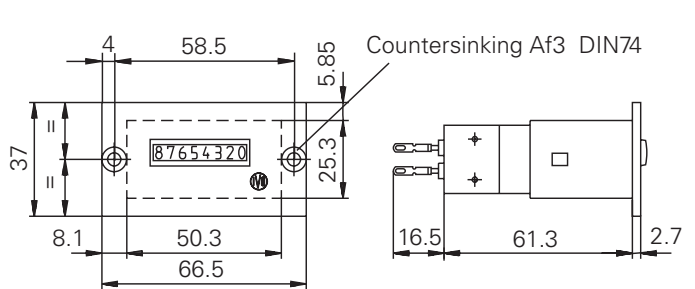

Pin assignments

Normal connection

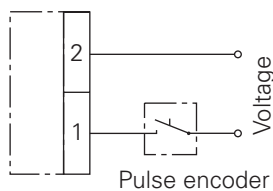

„H“-connection

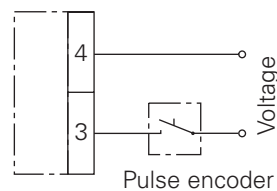

F 504, F 514, F 518, **F 524**, F 544, F 574

Dimensions and cutout sizes

F 524 with reset button, 6-digit display

Cutout 51 x 26 mm

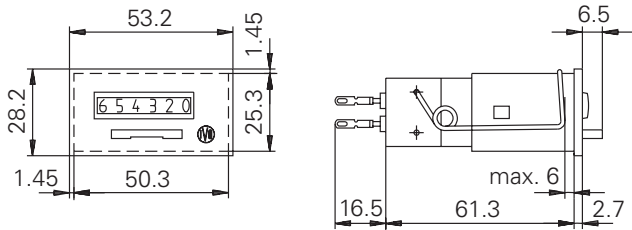

Dimensions and cutout sizes

F 524 without reset, 6-digit und 8-digit display

Cutout 51 x 26 mm

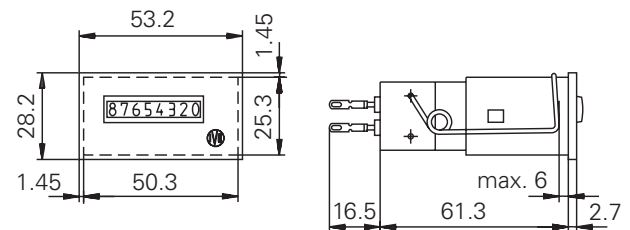

F 544 with reset button, 6-digit display

Cutout 51 x 26 mm

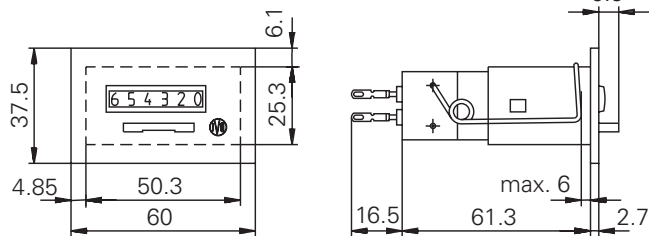

F 544 without reset, 6-digit display

Cutout 51 x 26 mm

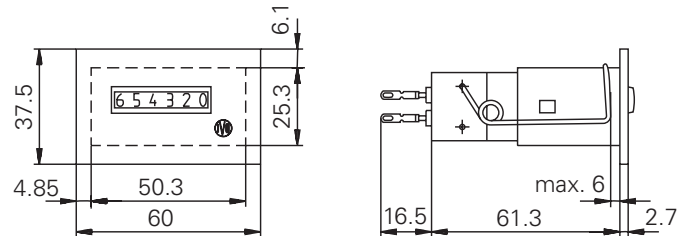

F 574 with reset button, 6-digit display

Cutout 51 x 26 mm

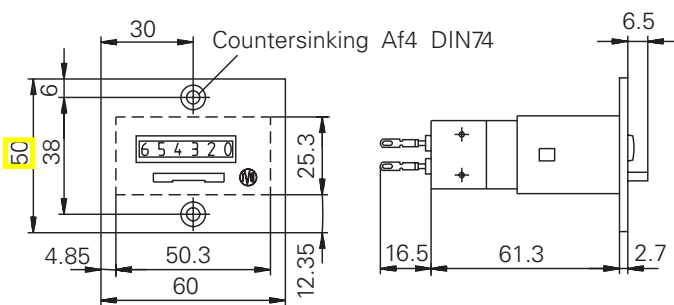

F 574 without reset, 6-digit display

Cutout 51 x 26 mm

