

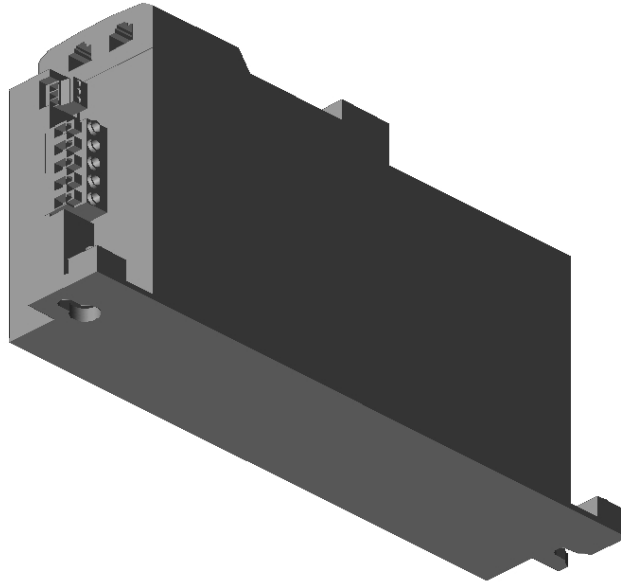



i550 Frequency inverter**I55AE222F10V1000LS**

Note: The model shown is a simplified representation. Minor deviations may occur.

-  16065141_3D.stp
-  16065141_datatable.csv
-  16065141_datatable.xls

3D Handling Commands

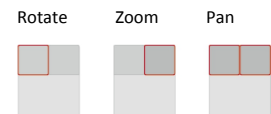
**Technical product information****i550 Frequency inverter****Inverter**

Type	i550-C2.2/400-3 I55AE222F10V1000LS
Rated power	2.2 kW/3 HP
Rated mains voltage	3/PE 400/480 V AC
Output current	5.6/4.8 A
RFI filter	Integrated
Output frequency	0-599 Hz
I/O extension	Standard I/O
Fieldbus network	PROFINET
Enclosure	IP20
Mounting location	Control cabinet
Weight / unit	1.630 KG

1.1 kW ... 4 kW

1.1 kW	i550-C1.1/230-1	i550-C1.1/230-2	i550-C1.1/400-3
1.5 kW	i550-C1.5/230-1	i550-C1.5/230-2	i550-C1.5/400-3
2.2 kW	i550-C2.2/230-1	i550-C2.2/230-2	i550-C2.2/400-3
3 kW			i550-C3.0/400-3
4 kW			i550-C4.0/400-3

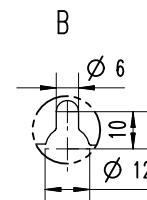
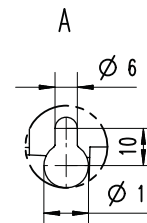
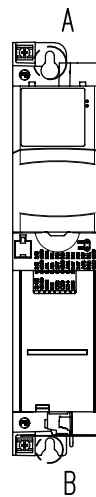
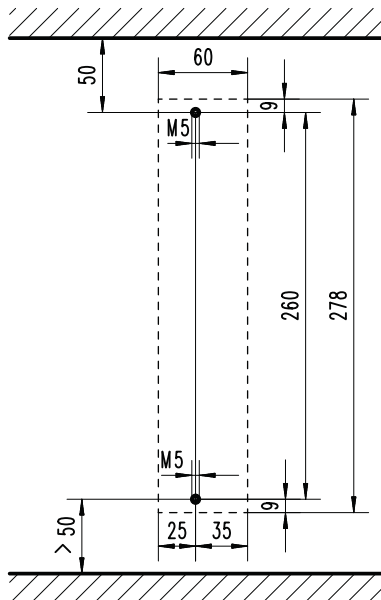
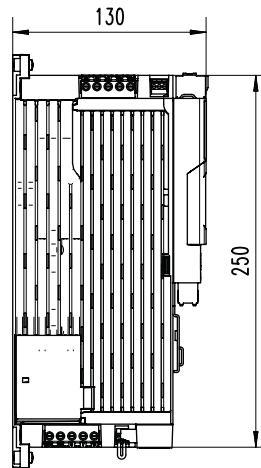
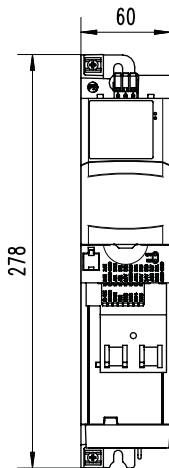

8800265



Inverter

Inverter i550-Cabinet

0.25 ... 132 kW

As easy as that.

Overview

Hardware overview of the inverter

PE connection

X100 Mains connection/DC bus

X9 Relay output

X2xx Network

Network status LEDs

X20 Memory module

X16 Interface
Diagnostic module

X3 Control terminals

X1 Safety module

IT-screws

X105 Motor connection

X109 PTC input

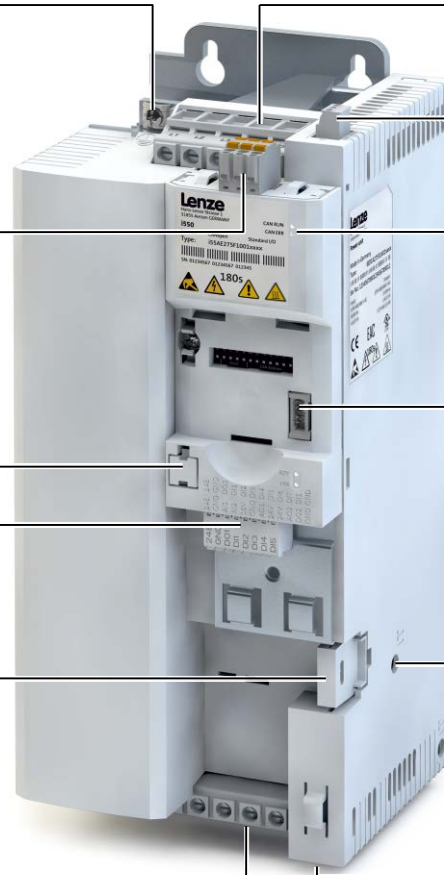

Content

1	General information	4	7	Commissioning	18
1.1	Target group	4	7.1	Keypad module	18
1.2	Application as directed	4	7.1.1	Functions of the keys	19
1.3	Device-specific standards and directives	4	7.1.2	Example of the keypad handling	19
1.4	Relevant standards and directives for the operator	4	7.1.3	Quick commissioning - terminal control	19
1.5	Identification of the products	5	7.1.4	Extended terminal control	20
2	Safety instructions	5	7.2	Keypad control	20
2.1	Basic safety measures	5	7.3	Commissioning with the EASY Starter	20
2.2	Layout of warning notices	6	7.4	The most important parameters at a glance	21
2.3	Residual hazards	6	7.4.1	Group 0: Favorites	21
3	Technical data	7	7.4.2	Group 2: Basic setting	26
3.1	Standards and operating conditions	7	7.4.3	Group 3: Motor control	26
3.2	Connection to the IT system	7	7.4.4	Group 7: Additional functions	26
4	Mechanical installation	8	8	Troubleshooting	27
4.1	Dimensions and assembly	8	8.1	Error message	27
5	Electrical installation	9	8.2	Reset error	27
5.1	General overview of the connections	9	8.3	Error codes	28
5.2	EMC-compliant installation	9	8.4	LED status	30
5.3	Control terminals	10	9	Further documents	30
5.4	Relay output	10	10	Disposal	30
5.5	PTC input	10	11	Glossary	30
5.6	1-phase mains connection 120 V	11			
5.7	1-phase mains connection 230/240 V	12			
5.8	3-phase mains connection 230/240 V	13			
5.9	3-phase mains connection 400 V	14			
5.10	3-phase mains connection 480 V	16			
6	Initial switch-on	18			

1 General information

Please read this documentation carefully before installing the inverter and observe the safety instructions!

This document only includes the most frequently asked questions and presents them in a simplified form for a better overview. Detailed technical and functional explanations can be found in the comprehensive product documentation.

The complete documentation, further information and tools regarding Lenze products can be found on the Internet: <http://www.Lenze.com>

1.1 Target group

Work on the product must only be carried out by qualified personnel. The personnel must be qualified in accordance with the IEC 60364 or CENELEC HD 384. Qualified personnel are persons who have the following knowledge and experience:

- They are familiar with the installation, mounting, commissioning, and operation of electrical and electronic modules.
- They have the corresponding qualifications for their work.
- They know and can apply all regulations for the prevention of accidents, directives, and laws applicable at the place of use.

1.2 Application as directed

The product is designed for the installation into electrical systems or machinery.

The i500 product family is designed for the power range of 0.25 ... 132 kW. The inverter i550 is suitable for conveyor and travelling drives, pumps, fans, winders, lifting systems and many other machine tasks. The inverter is not to be used as a household appliance, but for commercial or professional purposes only.

The inverter is not a machine in terms of the Machinery Directive.

1.3 Device-specific standards and directives

- The product meets the protection requirements of the Low-Voltage Directive 2014/35/EU.
- The harmonized standard EN 61800-5-1 is used for the inverters.

1.4 Relevant standards and directives for the operator

Application as directed

- If the product is used in accordance with the technical data, the drive systems comply with the EN 61800-3 categories.
- The inverter may only be used commercially or professionally as defined by EN 61000-3-2.
- The test voltage for insulation resistance tests between a control potential of 24 V and PE must be measured in accordance with EN 61800-5-1.
- The cables must be installed in accordance with EN 60204-1 or US National Electrical Code NFPA 70 / Canadian Electrical Code C22.1.

Commissioning

- Commissioning or starting the operation as directed of a machine with the product is prohibited until it has been ensured that the machine meets the regulations of the Machinery Directive (2006/42/EC) and the standard EN 60204-1.
- Commissioning or starting the operation as directed is only permissible if the EMC Directive 2014/30/EU is complied with.

1.5 Identification of the products

		I	5	5	A	E	xxx	x	1	x	x	x	x	xxxx
Product type	Inverter	I												
Product family	i500		5											
Product	i550			5										
Product generation	Generation 1				A									
Mounting type	Control cabinet mounting					E								
Rated power [hp] (examples)	0.33 hp						125							
	10 hp						275							
	125 hp						390							
	150 hp						411							
Mains voltage and connection type (examples)	1/N/PE AC 120 V							A						
	3/PE AC 230/240 V							B						
Motor connections	Single axis								1					
Integrated functional safety	Without safety function									0				
	Basic Safety STO									A				
Degree of protection	IP20, coated										V			
Interference suppression	Without											0		
	Integrated RFI filter											1		
Application	Default parameter setting: Region US (60-Hz networks)												1	
Design types (examples)	Standard I/O without network													000S
	Application I/O without network													001S

2 Safety instructions

2.1 Basic safety measures

Disregarding the following basic safety measures may lead to severe personal injury and damage to property!

- The product:
 - must only be used as directed.
 - must never be commissioned if they display signs of damage.
 - must never be technically modified.
 - must never be commissioned if they are not fully mounted.
 - must never be operated without required covers.
 - must only be disconnected from the installation in de-energized condition.
- Connect/disconnect all pluggable terminals only in de-energized condition.
- Carry out insulation resistance tests between 24-V control potential terminals and PE. The maximum test voltage must not exceed 110 V DC.

The safety measures are the condition for safe and trouble-free operation and the achievement of the specified product features.

The procedural notes and circuit details given in this document are suggestions and their transferability to the respective application has to be checked. The manufacturer does not take responsibility for the suitability of the process and circuit proposals.

The product may cause EMC interferences. The operator is responsible for executing the interference suppression measures.

2.2 Layout of warning notices

Safety instructions protect against injury to persons or damage to property. The measures described for the prevention of hazards must be complied with.



DANGER

Indicates an extremely hazardous situation. Failure to comply with this instruction will result in severe irreparable injury and even death.



WARNING

Indicates an extremely hazardous situation. Failure to comply with this instruction may result in severe irreparable injury and even death.



CAUTION

Indicates a hazardous situation. Failure to comply with this instruction may result in slight to medium injury.

NOTE

Indicates a material hazard. Failure to comply with this instruction may result in material damage.





2.3 Residual hazards

The user must take the residual hazards mentioned into consideration in the risk assessment for his/her machine/system.

If the above is disregarded, this may result in injuries to persons and material damage!

Product

Observe the warning labels on the product!

Icon	Description
	Electrostatic charge Before working on the product, the staff must ensure to be free of electrostatic charge.
	Electrical voltage Before working on the product, check if no voltage is applied to the power terminals! After mains disconnection, the power terminals carry the hazardous electrical voltage given on the product!
	High leakage current Implement fixed installation and PE connection!
	Hot surface Use personal protective equipment or wait until the device has cooled down!

Motor

In the event of a short circuit of two power transistors, a residual movement of up to 180°/ number of pole pairs on the motor may occur (e.g. 4-pole motor): residual movement max. $180^\circ/2 = 90^\circ$).

3 Technical data

3.1 Standards and operating conditions

Conformities	CE	2014/35/EU, 2014/30/EU
	EAC	TR TC 004/2011, TP TC 020/2011
	RoHS 2	2011/65/EU
Approvals	CULUS	UL 61800-5-1, CSA 22.2 No. 274
Energy efficiency	Class IE2	EN 50598-2
Degree of protection	IP20	EN 60529 (except in wire range of terminals)
		NEMA 250 (type 1 protection against accidental contact only)
	Open type	Only in UL-approved systems
Power systems	TT, TN	Voltage against earth: max. 300 V
	IT	Apply the measures described for IT systems!
Mains switching		3 x within one minute possible
Operation with residual current circuit breaker (optional) (120-V network and 230-V network)		Up to 4 kW 30 mA, above this 300 mA
		Up to 4 kW 30 mA, above this 300 mA
Cable length without EMC category		max. 100 m (≤ 5.5 kW max. 50 m)
		max. 100 m (≤ 5.5 kW max. 50 m)
Cable length for EMC	Category C2	max. 20 m (≤0.37 kW max. 15 m)
	Category C3	max. 35 m (≤0.37 kW max. 15 m)
Switching frequencies		2, 4, 8, 16 kHz. The rated output currents apply at 45 °C and switching frequencies of 2 and 4 kHz, and at 40 °C and switching frequencies of 8 and 16 kHz
Ambient temperature		55 °C (derating of 2.5 %/ °C above 45 °C)
Max. output frequency		0 Hz ... 599 Hz
Overload capacity (120-V network and 230-V network)		200 % for 3 s; 150 % for 60 s
Overload capacity (400-V network)		200 % for 3 s; Heavy Duty: 150 % for 60 s; Light Duty: 125 % for 60 s

3.2 Connection to the IT system

NOTE

Electrical voltage

Internal components have earth/ground potential if the IT screws are not removed.

The monitoring devices of the IT system will be triggered.

► Before connection to an IT system be absolutely sure to remove the IT screws.



4 Mechanical installation

4.1 Dimensions and assembly

	Rated power [kW]	Weight [kg]	H [mm]	B [mm]	T [mm]	H1 [mm]	X/Y [screws + hole spacing]		E1 [mm]	E2 [mm]	
1-phase mains connection 120 V; without integrated RFI filter											
I55AExxxA	0.25 ... 0.37	1	180	60	130	190	1/1	-	M5	50	50
I55AExxxA	0.75 ... 1.1	1.35	250	60	130	260	1/1	-	M5	50	50
1-phase mains connection 230/240 V; with integrated RFI filter											
I55AExxxB	0.25 ... 0.37	0.8	155	60	130	165	1/1	-	M5	50	50
I55AExxxB	0.55 ... 0.75	1	180	60	130	190	1/1	-	M5	50	50
I55AExxxB	1.1 ... 2.2	1.35	250	60	130	260	1/1	-	M5	50	50
1-/3-phase mains connection 230/240 V; without integrated RFI filter											
I55AExxxD	0.25 ... 0.37	0.8	155	60	130	165	1/1	-	M5	50	50
I55AExxxD	0.55 ... 0.75	1	180	60	130	190	1/1	-	M5	50	50
I55AExxxD	1.1 ... 2.2	1.35	250	60	130	260	1/1	-	M5	50	50
I55AExxxC	4 ... 5.5	2.1	250	90	130	260	1/1	-	M5	50	100
3-phase mains connection 400 V ... Heavy Duty; with integrated RFI filter											
I55AExxxF	0.37	0.8	155	60	130	165	1/1	-	M5	50	50
I55AExxxF	0.55 ... 0.75	1	180	60	130	190	1/1	-	M5	50	50
I55AExxxF	1.1 ... 2.2	1.35	250	60	130	260	1/1	-	M5	50	50
I55AExxxF	3 ... 5.5	2.1	250	90	130	260	2/2	30	M5	50	100
I55BExxxF	3 ... 4	1.35	250	60	130	260	1/1	-	M5	50	50
I55AExxxF	7.5 ... 11	3.7	276	120	130	285	2/2	60	M5	50	100
I55AExxxF	15 ... 22	10.3	347	204.5	222	343	2/2	180	M6	50	100
I55AExxxF	30 ... 45	17.2	450	250	230	496	2/2	210	M8	95	120
I55AExxxF	55 ... 75	24	536	250	265	596	2/2	210	M8	95	260
I55AExxxF	90 ... 110	35.6	685	258	304	748	2/2	210	M8	95	260
3-phase mains connection 400 V - Light Duty; with integrated RFI filter											
I55AExxxF	4 ... 7.5	2.3	250	90	130	260	2/2	30	M5	50	100
I55BExxxF	3 ... 4	1.35	250	60	130	260	1/1	-	M5	50	50
I55AExxxF	11 ... 15	3.7	276	120	130	285	2/2	60	M5	50	100
I55AExxxF	18.5 ... 30	10.3	347	204.5	222	343	2/2	180	M6	50	100
I55AExxxF	37 ... 55	17.2	450	250	230	496	2/2	210	M8	95	120
I55AExxxF	75 ... 90	24	536	250	265	596	2/2	210	M8	95	260
I55AExxxF	110 ... 132	35.6	685	258	304	748	2/2	210	M8	95	260

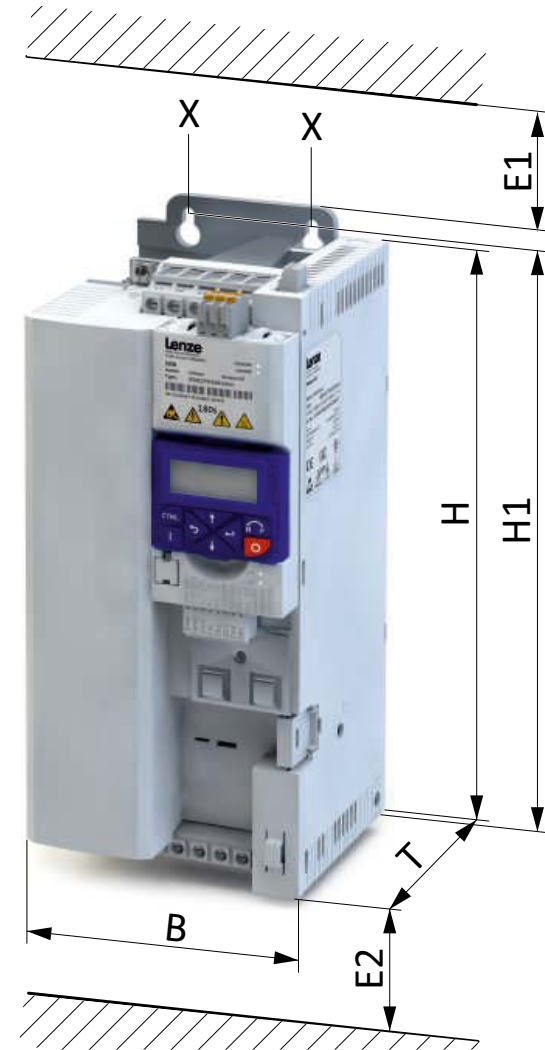

H: Device height
 B: Device width
 T: Device depth
 H1: Hole dimension for top/bottom fixing

X/Y: Number of top/bottom fixings
 (Y not visible in the illustration)
 X - X: Hole spacing over center of device
 E1: Top mounting clearance
 E2: Bottom mounting clearance

5 Electrical installation

5.1 General overview of the connections

The connection diagram is considered exemplary for all voltage and power classes. Deviating mains connection diagrams can be found in the corresponding chapters.

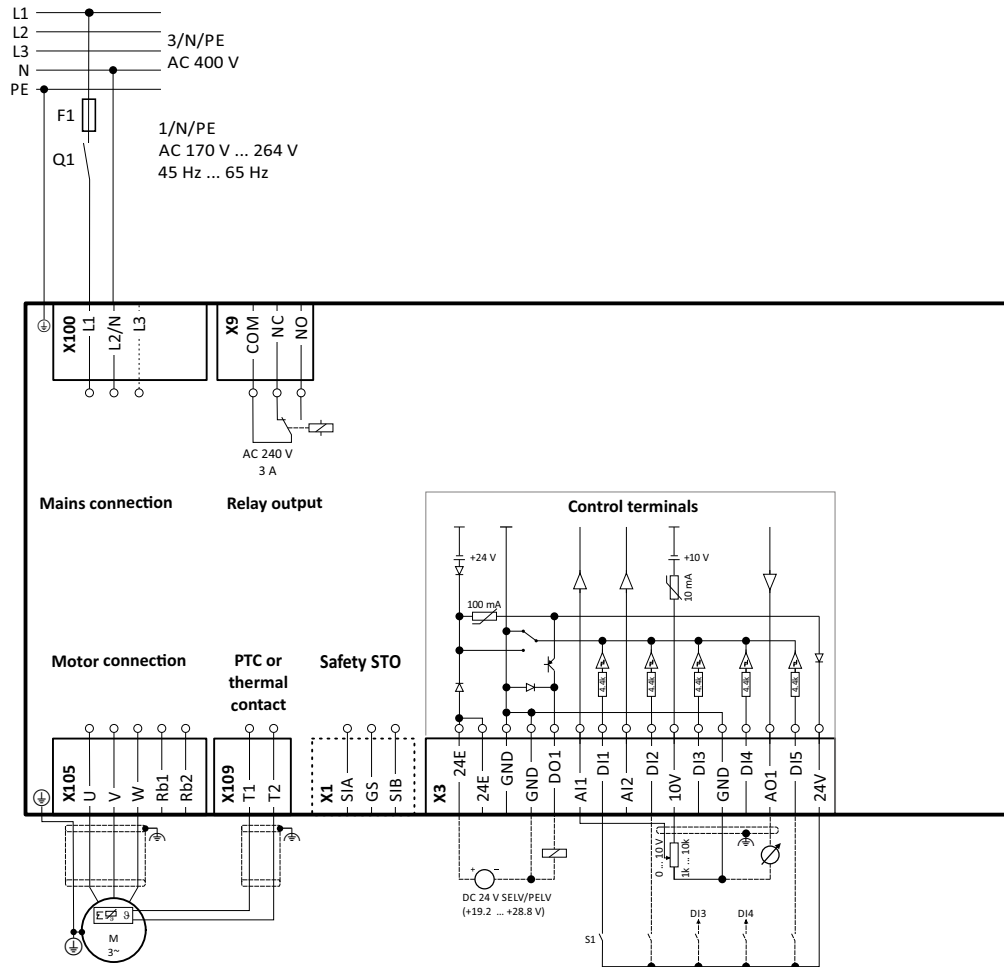

5.2 EMC-compliant installation

The drive system (inverter and drive) meet the EMC Directive 2014/30/EU if they are installed according to the guidelines of CE-typical drive systems.

The structure in the control cabinet must support the EMC-compliant installation with shielded motor cables.

- Please use sufficiently conductive shield connections.
- Connect the housing with shielding effect to the grounded mounting plate with a surface as large as possible, e. g. of inverters and RFI filters.
- Use central earthing points.

The following figure shows an effective wiring with shielding on the control cabinet wall.

- A Shield connection for control connections
- B Control cable
- C Electrically conductive mounting plate
- D Shield clamps
- E Low-capacitance motor cable
(C-core/core/C-core/shield <math>< 75/150 \text{ pF/m} \leq 2.5 \text{ mm}^2</math>;
C-core/core/C-core/shield <math>< 150/300 \text{ pF/m} \geq 4 \text{ mm}^2</math>)

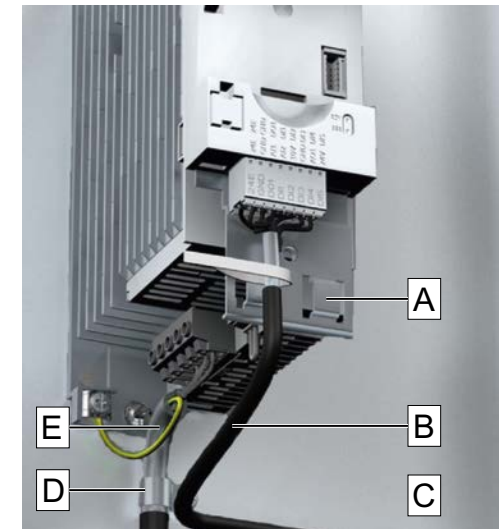

Alternatively, the motor cable can be shielded on an optional motor shield plate.

5.3 Control terminals

Standard I/O

Input/output	Terminal X3	Information
Digital inputs	DI1, DI2, DI3, DI4, DI5	DI3/DI4 can be optionally used as frequency or encoder input. HIGH-active/LOW-active switchable LOW = 0 ... +3 V, HIGH = +12 V ... +30 V
Digital outputs	DO1	Digital output (max. 100 mA for DO1 and 24-V output)
Analog inputs	AI1, AI2	Can be optionally used as voltage input or current input.
Analog outputs	AO1	Can be optionally used as voltage output or current output.
24-V input	24E	Input for mains-independent power DC supply of control electronics (including communication). Max. 1 A
10-V output	10 V	Primarily for the supply of a potentiometer (1 ... 10 kΩ). Max. 10 mA
24-V output	24 V	Primarily for the supply of digital inputs. (Max. 100 mA for DO1 and 24-V output)
Reference potential	GND	
Connection system	Pluggable spring terminal	

Inverter	[kW]	0.25 ... 132
Connection		Control terminals X3
Connection type		Pluggable spring terminal
Min. cable cross-section	mm ²	-
Max. cable cross-section	mm ²	1.5
Stripping length	mm	9
Tightening torque	Nm	-
Tools required		0.4 x 2.5

Control terminals

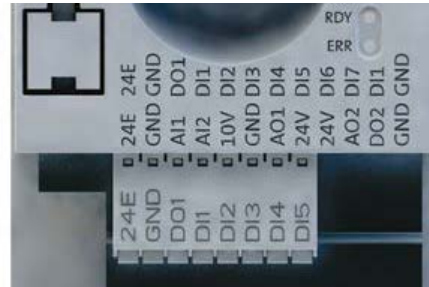
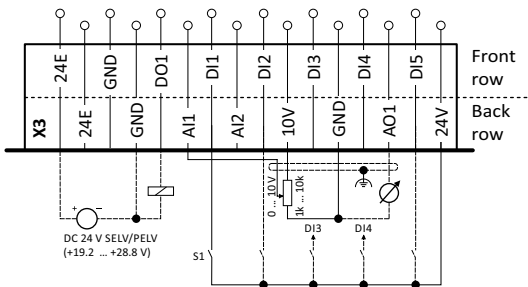

5.4 Relay output

The relay is not suitable for direct switching of an electromechanical holding brake.

Use a corresponding suppressor circuit in case of an inductive or capacitive load.

Inverter	[kW]	0.25 ... 132
Connection		Relay output X9
Connection type		Pluggable screw terminal
Min. cable cross-section	mm ²	-
Max. cable cross-section	mm ²	1.5
Stripping length	mm	6
Tightening torque	Nm	0.2
Tools required		0.4 x 2.5
	COM	Common contact
	NC	Normally-closed contact
	NO	Normally-open contact
Max. switching voltage/switching current		AC 240 V/3 A
		DC 24 V/2 A
		DC 240 V/0.16 A

Relay output

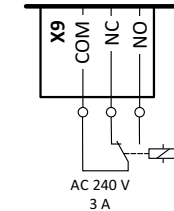

5.5 PTC input

In the default setting, the motor temperature monitoring is active! By default, a wire jumper is installed between the terminals T1 and T2.

Before connecting a thermal sensor, remove the wire jumper.

Inverter	[kW]	0.25 ... 132
Connection		PTC or thermal contact X109
		Terminal X109: T1
		Terminal X109: T2
Sensor types		PTC single sensor
		PTC triplet sensor
		Thermal contact

PTC input

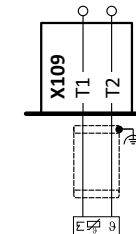

5.6 1-phase mains connection 120 V

Terminal data, 1-phase 120 V

Inverter	[kW]	I55AxxxA 0.25 ... 0.37	I55AxxxA 0.75 ... 1.1	I55AxxxA 0.25 ... 1.1	I55AxxxA 0.25 ... 1.1
Connection		Mains connection X100		PE connection	Motor connection X105
Connection type		Pluggable screw terminal		PE screw	Pluggable screw terminal
Min. cable cross-section	mm ²	1		1.5	1
Max. cable cross-section	mm ²	2.5	6	6	2.5
Stripping length	mm	8		10	8
Tightening torque	Nm	0.5	0.7	2	0.5
Tools required		0.5 x 3.0	0.6 x 3.5	Torx 20	0.5 x 3.0

Fusing data

Inverter	[kW]	0.25	0.37	0.75	1.1
Rated output current (8 kHz)	A	1.7	2.4	4.2	6
Max. output current (15 s)	A	2.6	3.6	6.3	9
Operation without mains choke					
Rated mains current	A	6.8	9.6	16.8	22.9
Fuse					
Characteristic		gG/gL or gRL			
Max. rated current	A	16	16	25	25
Circuit breaker					
Characteristic		B			
Max. rated current	A	16	16	25	25
Earth-leakage circuit breaker					
1-phase mains connection		≥ 30 mA, type B			

Mains connection

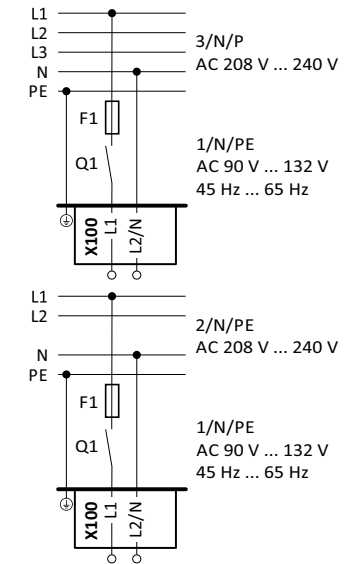

Motor connection

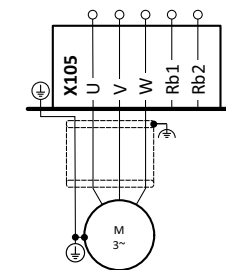

5.7 1-phase mains connection 230/240 V

Terminal data, 1-phase 230/240 V

Inverter	[kW]	I55AxxxB	I55AxxxA	I55AxxxA	I55AxxxA
Connection		Mains connection X100		PE connection	Motor connection X105
Connection type		Pluggable screw terminal		PE screw	Pluggable screw terminal
Min. cable cross-section	mm ²	-		-	-
Max. cable cross-section	mm ²	2.5	6	6	2.5
Stripping length	mm	8		10	8
Tightening torque	Nm	0.5	0.7	2	0.5
Tools required		0.5 x 3.0	0.6 x 3.5	Torx 20	0.5 x 3.0

Fusing data

Inverter	[kW]	0.25	0.37	0.55	0.75	1.1	1.5	2.2
Rated output current (8 kHz)	A	1.7	2.4	3.2	4.2	6	7	9.6
Max. output current (15 s)	A	2.6	3.6	4.8	6.3	9	10.5	14.4
Operation without mains choke								
Rated mains current	A	4	5.7	7.6	10	14.3	16.7	22.5
Fuse								
Characteristic		gG/gL or gRL						
Max. rated current	A	10	10	16	16	25	25	25
Circuit breaker								
Characteristic		B						
Max. rated current	A	10	10	16	16	25	25	25
Earth-leakage circuit breaker								
1-phase mains connection		≥ 30 mA, type B						

Mains connection

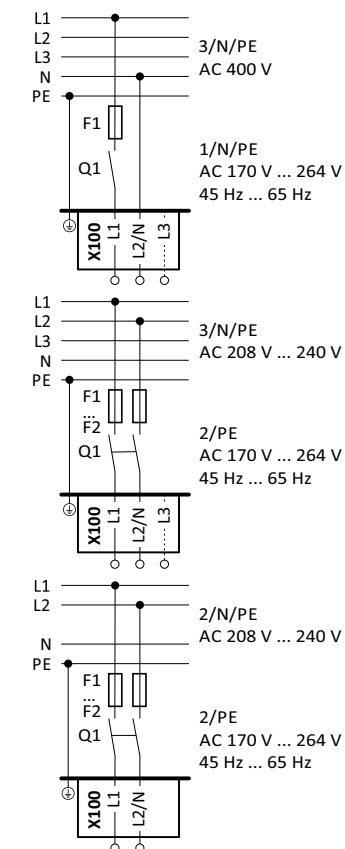

Motor connection

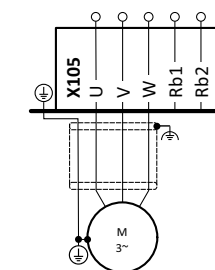

5.8 3-phase mains connection 230/240 V

Terminal data, 3-phase 230/240 V

Inverter	[kW]	I55AxxxD	I55AxxxD	I55AxxxC	I55AxxxX	I55AxxxD	I55AxxxC
		0.25 ... 0.75	1.1 ... 2.2	4 ... 5.5	0.25 ... 5.5	0.25 ... 2.2	4 ... 5.5
Connection		Mains connection X100			PE connection	Motor connection X105	
Connection type		Pluggable screw terminal		Screw terminal	PE screw	Pluggable screw terminal	Screw terminal
Min. cable cross-section	mm ²	-			-	-	
Max. cable cross-section	mm ²	2.5	6	6	6	2.5	6
Stripping length	mm	8			10	8	
Tightening torque	Nm	0.5	0.7	0.5	2	0.5	0.5
Tools required		0.5 x 3.0	0.6 x 3.5	0.6 x 3.5	Torx 20	0.5 x 3.0	0.6 x 3.5

Fusing data

Inverter	[kW]	0.25	0.37	0.55	0.75	1.1	1.5	2.2	4	5.5	
Rated output current (8 kHz) (Heavy Duty)	A	1.7	2.4	3.2	4.2	6	7	9.6	16.5	23	
Max. output current (15 s)	A	2.6	3.6	4.8	6.3	9	10.5	14.4	24.8	34.5	
Rated output current (Light Duty)	A	-	-	-	-	-	-	-	-	20.6	
Max. output current (15 s)	A	-	-	-	-	-	-	-	-	24.8	
Operation without mains choke											
Rated mains current	A	2.6	3.9	4.8	6.4	7.8	9.5	13.6	20.6	28.8	
Fuse											
Characteristic		gG/gL or gRL									
Max. rated current	A	10	10	16	16	25	25	25	32	32	
Circuit breaker											
Characteristic		B									
Max. rated current	A	10	10	16	16	25	25	25	32	32	
Earth-leakage circuit breaker											
3-phase mains connection		≥ 30 mA, type B								≥ 300 mA, type B	

Mains connection

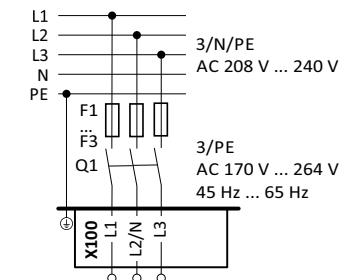
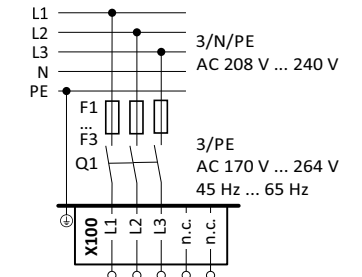

Motor connection

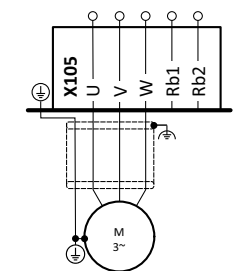

5.9 3-phase mains connection 400 V

Terminal data, 3-phase 400 V

Inverter	[kW]	I55AxxxF	I55BxxxF	I55AxxxF	I55AxxxF	I55AxxxF	I55AxxxF	I55AxxxF	I55AxxxF	I55AxxxF	I55AxxxF	I55AxxxF	I55AxxxF	I55AxxxF
Connection		Mains connection X100					PE connection			Motor connection X105				
Connection type		Pluggable screw terminal		Screw terminal			PE screw			Pluggable screw terminal		Screw terminal		
Min. cable cross-section	mm ²	1					1.5			1				
Max. cable cross-section	mm ²	2.5	4	6	16	35	6	16	25	2.5	6	16	35	
Stripping length	mm	8	8	9	11	18	10	11	16	8	9	11	18	
Tightening torque	Nm	0.5	0.6	0.5	1.2	3.8	2	3.4	4	0.5	0.5	1.2	3.8	
Tools required		0.5 x 3.0		0.6 x 3.5	0.6 x 4.0	0.6 x 5.5	Torx 20	P22	P22	0.5 x 3.0		0.6 x 3.5	0.8 x 4.0	0.8 x 5.5

Fusing data/performance data

Inverter	[kW]	0.37	0.55	0.75	1.1	1.5	2.2	3	4	5.5	7.5	11	15	18.5	22	
Rated output current (8 kHz) (Heavy Duty)	A	1.3	1.8	2.4	3.2	3.9	5.6	7.3	9.5	13	16.5	23.3	32	40	47	
Max. output current (15 s)	A	2	2.7	3.6	4.8	5.9	8.4	11	14.3	19.5	25	35	48	60	71	
Rated output current (Light Duty)	A	-	-	-	-	-	-	-	8.8	11.9	15.6	23	28.2	38.4	48	
Max. output current (15 s)	A	-	-	-	-	-	-	-	11	14.3	19.5	23.6	35	48	60	
Operation without mains choke																
Rated mains current	A	1.8	2.5	3.3	4.4	5.4	7.8	9.6	12.5	17.2	20	28.4	38.7	48.4	-	
Fuse		gG/gL or gRL														
Characteristic																
Max. rated current	A	10	10	10	16	16	16	25	25	25	32	32	63	63	-	
Circuit breaker		B														
Characteristic																
Max. rated current	A	10	10	10	16	16	16	25	25	25	32	32	63	63	-	
Operation with mains choke																
Rated mains current	A	1.4	2	2.6	3	3.7	5.3	6.9	9	12.4	15.7	22.3	28.8	36	42	
Fuse		gG/gL or gRL														
Characteristic																
Max. rated current	A	10	10	10	16	16	16	25	25	25	32	32	63	63	63	
Circuit breaker		B														
Characteristic																
Max. rated current	A	10	10	10	16	16	16	25	25	25	32	32	63	63	63	
Earth-leakage circuit breaker																
3-phase mains connection		≥ 30 mA, type B					≥ 300 mA, type B									

In case of Light Duty above 15 kW and Heavy Duty above 22 kW, a mains choke must be used.

Mains connection

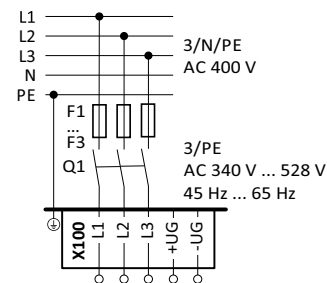

Motor connection

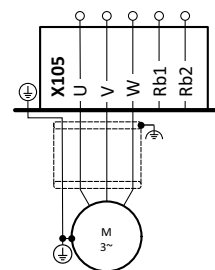

Terminal data, 3-phase 400 V

		I55AxxxF	I55AxxxF	I55AxxxF	I55AxxxF	I55AxxxF	I55AxxxF	I55AxxxF	I55AxxxF
Inverter	[kW]	30 ... 45	55 ... 75	90 ... 132	30 ... 75	90 ... 132	30 ... 45	55 ... 75	90 ... 132
Connection		Mains connection X100			PE connection		Motor connection X105		
Connection type		Screw terminal			PE screw	PE bolt	Screw terminal		
Min. cable cross-section	mm ²	1			1.5		1		
Max. cable cross-section	mm ²	50	95	150	25	150	50	95	150
Stripping length	mm	19	22	28	16	-	19	22	28
Tightening torque	Nm	4	10	18	4	10	4	10	18
Tools required		Hexagon socket 5	Hexagon socket 6	Hexagon socket 8	PZ2	Wrench size 13	Hexagon socket 5	Hexagon socket 6	Hexagon socket 8

Mains connection

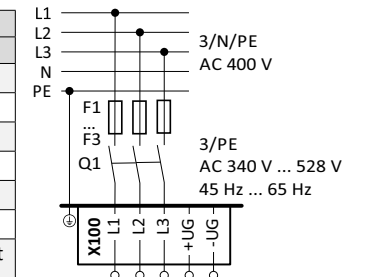

Fusing data

Inverter	[kW]	30	37	45	55	75	90	110	132
Rated output current (Heavy Duty)	A	61	76	89	110	150	180	212	-
Max. output current (15 s)	A	92	114	134	165	225	270	318	-
Rated output current (Light Duty)	A	56.4	73.2	91.2	107	132	180	216	254
Max. output current (15 s)	A	71	92	114	135	165	225	270	318
Operation with mains choke									
Rated mains current	A	54.9	68	80	99	135	168	198	-
Fuse									
Characteristic		gG/gL or gRL			gR				
Max. rated current	A	80	100	125	160	16	300	300	300
Circuit breaker									
Characteristic		B							
Max. rated current	A	80	100	125	-	-	-	-	-
Earth-leakage circuit breaker									
3-phase mains connection		≥ 300 mA, type B							

Motor connection

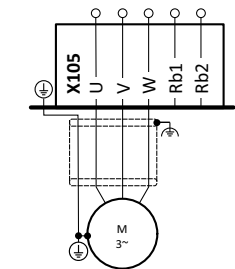

In case of Light Duty above 15 kW and Heavy Duty above 22 kW, a mains choke must be used.

5.10 3-phase mains connection 480 V

Terminal data, 3-phase 480 V

Inverter	[kW]	I55AxxxF	I55BxxxF	I55AxxxF	I55AxxxF	I55AxxxF	I55AxxxF	I55AxxxF	I55AxxxF	I55AxxxF	I55BxxxF	I55AxxxF	I55AxxxF	I55AxxxF
Connection		Mains connection X100					PE connection			Motor connection X105				
Connection type		Pluggable screw terminal		Screw terminal			PE screw			Pluggable screw terminal		Screw terminal		
Min. cable cross-section	mm ²	1					1.5			1				
Max. cable cross-section	mm ²	2.5	4	6	16	35	6	16	25	2.5	2.5	6	16	35
Stripping length	mm	8	8	9	11	18	10	11	16	8	8	9	11	18
Tightening torque	Nm	0.5	0.6	0.5	1.2	3.8	2	3.4	4	0.5	0.5	0.5	1.2	3.8
Tools required		0.5 x 3.0	0.5 x 3.0	0.6 x 3.5	0.8 x 4.0	0.8 x 5.5	Torx key 20	PZ2		0.5 x 3.0	0.5 x 3.0	0.6 x 3.5	0.8 x 4.0	0.8 x 5.5

Fusing data/performance data

Inverter	[kW]	0.37	0.55	0.75	1.1	1.5	2.2	3	4	5.5	7.5	11	15	18.5	22	
Rated output current (8 kHz) (Heavy Duty)	A	1.1	1.6	2.1	3	3.5	4.8	6.3	8.2	11	14	21	27	34	40.4	
Max. output current (15 s)	A	1.7	2.4	3.2	4.5	5.3	7.2	9.5	12.3	16.5	21	31.5	40.5	51	61	
Rated output current (Light Duty)	A	-	-	-	-	-	-	-	7.6	9.8	13.2	18.3	25.2	32.4	40.8	
Max. output current (15 s)	A	-	-	-	-	-	-	-	9.5	12.3	16.5	21	31.5	40.5	51	
Operation without mains choke																
Rated mains current	A	1.5	2.1	2.8	3.7	4.5	6.5	8	10.5	14.3	16.6	23.7	32.3	40.3	47.4	
Fuse																
Characteristic		gG/gL or gRL														
Max. rated current	A	10	10	10	16	16	16	25	25	25	32	32	63	63	63	
Circuit breaker																
Characteristic		B														
Max. rated current	A	10	10	10	16	16	16	25	25	25	32	32	63	63	63	
Operation with mains choke																
Rated mains current	A	1.2	1.7	2.2	2.5	3.1	4.4	5.8	7.5	10.3	13.1	18.6	24	30	35.3	
Fuse																
Characteristic		gG/gL or gRL														
Max. rated current	A	10	10	10	16	16	16	25	25	25	32	32	63	63	63	
Circuit breaker																
Characteristic		gG/gL or gRL														
Max. rated current	A	10	10	10	16	16	16	25	25	25	32	32	63	63	63	
Earth-leakage circuit breaker																
3-phase mains connection		≥ 30 mA, type B					≥ 300 mA, type B									

In case of Light Duty above 15 kW and Heavy Duty above 30 kW, a mains choke must be used.

Mains connection

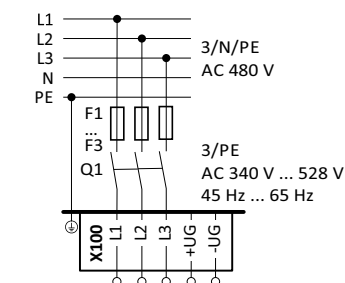

Motor connection

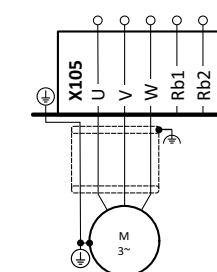

Terminal data, 3-phase 480 V

Inverter	[kW]	I55AxxxF 30 ... 45	I55AxxxF 55 ... 75	I55AxxxF 90 ... 132	I55AxxxF 30 ... 75	I55AxxxF 90 ... 132	I55AxxxF 30 ... 45	I55AxxxF 55 ... 75	I55AxxxF 90 ... 132
Connection		Mains connection X100			PE connection		Motor connection X105		
Connection type		Screw terminal			PE screw	PE bolt	Screw terminal		
Min. cable cross-section	mm ²	1			1.5		1		
Max. cable cross-section	mm ²	50	95	150	25	150	50	95	150
Stripping length	mm	19	22	28	16	-	19	22	28
Tightening torque	Nm	4	10	18	4	10	4	10	18
Tools required		Hexagon socket 5	Hexagon socket 6	Hexagon socket 8	PZ2	Wrench size 13	Hexagon socket 5	Hexagon socket 6	Hexagon socket 8

Mains connection

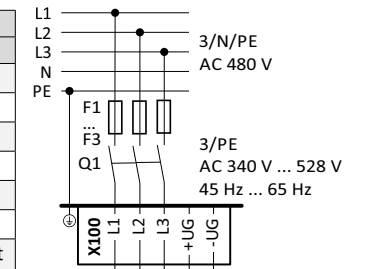

Fusing data

Inverter	[kW]	30	37	45	55	75	90	110	132
Rated output current (8 kHz) (Heavy Duty)	A	52	65	77	96	124	156	180	-
Max. output current (15 s)	A	78	98	116	144	186	234	270	-
Rated output current (Light Duty)	A	48.5	62.4	78	92.4	115	149	187	216
Max. output current (15 s)	A	61	78	98	116	144	186	234	270
Operation with mains choke									
Rated mains current	A	45.7	57	66.7	83	113	146	168	-
Fuse									
Characteristic		gG/gL or gRL				gR			
Max. rated current	A	80	100	125	160	160	300	300	300
Circuit breaker									
Characteristic		B							
Max. rated current	A	80	100	125	-	-	-	-	-
Earth-leakage circuit breaker									
3-phase mains connection		≥ 300 mA, type B							

Motor connection

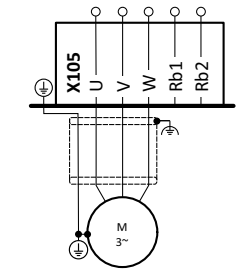

In case of Light Duty above 15 kW and Heavy Duty above 30 kW, a mains choke must be used.

6 Initial switch-on



DANGER

Electrical voltage

Incorrect wiring can cause unexpected states during the commissioning phase.

- ▶ Wiring must be complete and correct.
- ▶ Wiring must be free of short circuits and earth faults.
- ▶ The motor circuit configuration (star/delta) must be adapted to the inverter.
- ▶ The motor must be connected in-phase (rotating direction).
- ▶ The "emergency off" function of the overall system must operate correctly.
- ▶ Clear hazardous area.
- ▶ Observe safety instructions and safety clearances.

Preconditions

- The power connections must be wired.
- The digital inputs X3/DI1 (start/stop), X3/DI3 (reversal) and X3/DI4 (frequency preset 20 Hz) must be wired.
- The analog input X3/AI1 must not be wired or connected to GND.

Switch on mains voltage

- ▶ Switch on mains voltage and check readiness for operation.

Observe LED status displays "RDY" and "ERR" on the inverter front panel.

See „LED status“.  30

7 Commissioning



DANGER

Electrical voltage

Incorrect wiring can cause unexpected states during the commissioning phase.

- ▶ Wiring must be complete and correct.
- ▶ Wiring must be free of short circuits and earth faults.
- ▶ The motor circuit configuration (star/delta) must be adapted to the inverter.
- ▶ The motor must be connected in-phase (rotating direction).
- ▶ The "emergency off" function of the overall system must operate correctly.
- ▶ Clear hazardous area.
- ▶ Observe safety instructions and safety clearances.

7.1 Keypad module

- ▶ Plug the keypad onto the inverter.

The keypad can also be connected and removed during operation.



7.1.1 Functions of the keys

Key	Actuation	Action
	Press briefly	<ul style="list-style-type: none"> Navigation in the menu Parameter alteration
	Press briefly	<ul style="list-style-type: none"> Go to Menu/Parameters Confirm parameter
	Press and hold for 3s	<ul style="list-style-type: none"> Save parameters "P.SAVED" in the display indicates that the parameters have been saved
	Press briefly	Quit Menu/Parameters
	Press briefly	Activate keypad control
	Press briefly	Start motor
	Press briefly	Change rotating direction
	Press briefly	Stop motor

The motor must be at standstill before parameters can be changed or confirmed.

The settings are saved temporarily until the motor is switched off again. To save the settings permanently, press and hold the key for 3 s.

7.1.2 Example of the keypad handling

Example for DO1 function assignment with parameter **P420.02**.

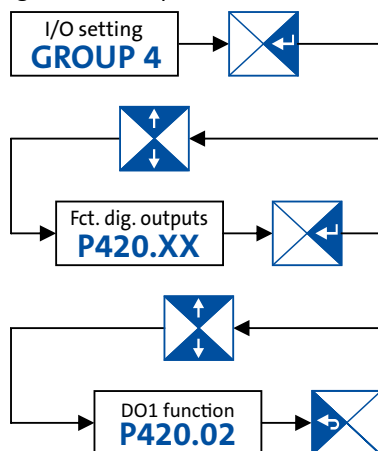

7.1.3 Quick commissioning - terminal control

The following quick overview with graphical parameter representation is sufficient for commissioning many applications with terminal control. Further setting options are described in this document or in the commissioning document.

- Load default setting = Set **P700.01** to 1.
- Set the following parameters for V/f characteristic control:
 - Mains voltage **P208.01**
 - V/f characteristic data: Base voltage **P303.01**
 - V/f characteristic data: Base frequency **P303.02**
 - Minimum frequency **P210.00**
 - Maximum frequency **P211.00**
 - Acceleration time 1 **P220.00**
 - Deceleration time 1 **P221.00**
 - Analog input 1: Min frequency value **P430.02**
 - Analog input 1: Max frequency value **P430.03**
- Press and hold the key longer than 3 seconds in order to save the settings.

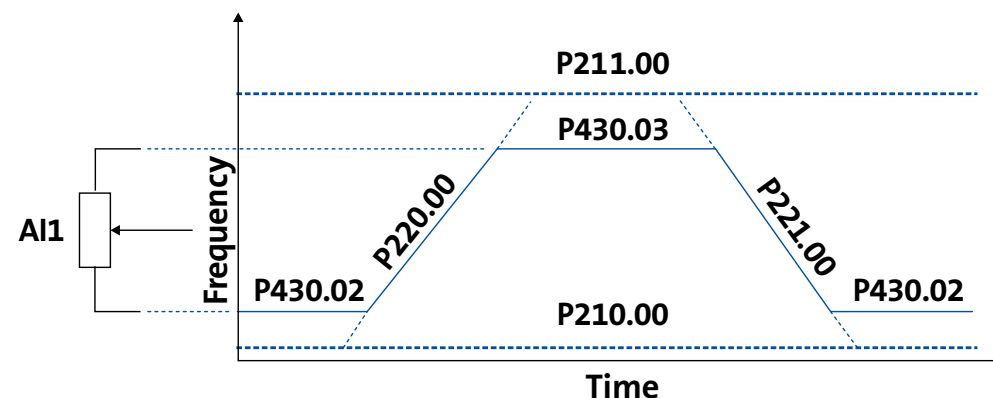

Commissioning

With the wiring shown below, the inverter can be operated using the control terminals (X3).

- Preset 1 is activated if DI4 is connected.
- Preset 2 is activated if DI5 is connected.
- Preset 3 is activated if DI4 and DI5 are connected at the same time.

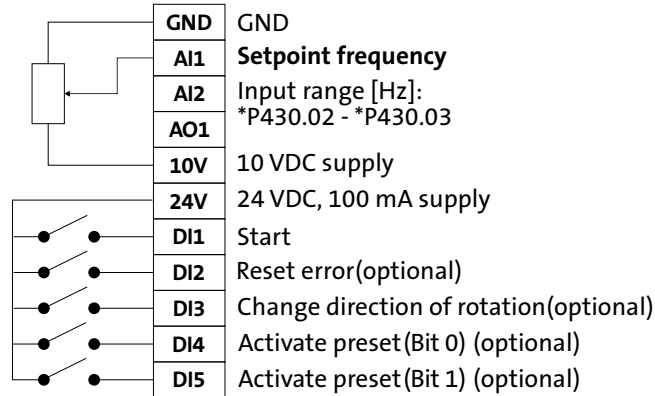

7.1.4 Extended terminal control

The following illustration shows a more extensive wiring of the control terminals (X3) linked with the respective parameters.

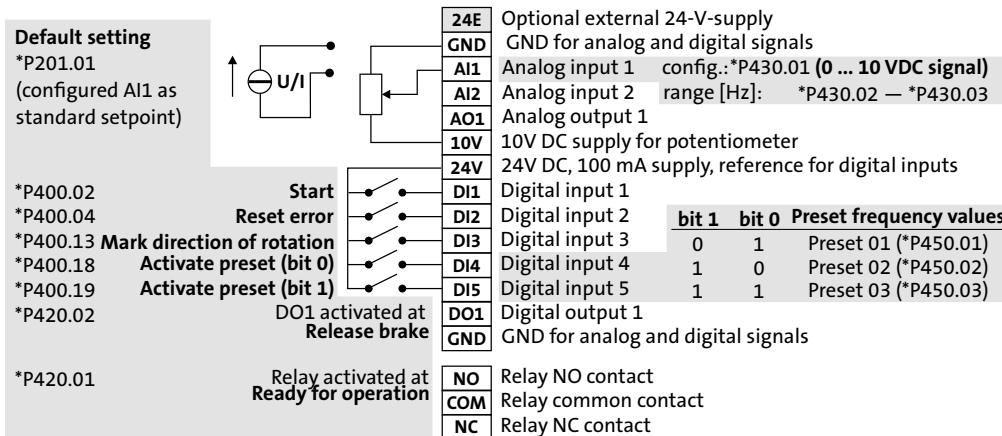

7.2 Keypad control

Activate temporary keypad control

1. Press the key to activate the keypad control.
2. Press the key to confirm the keypad control.

Deactivate temporary keypad control

1. Press the key to deactivate the keypad control.
2. Press the key to confirm the keypad control.

Activate permanent keypad control

If the keypad does not have a key, the motor control is activated via the following parameters:

- ▶ Set parameter **P200.00** to **1**.
- ▶ Set parameter **P201.01** to **1**.
- ▶ Set parameter **P400.01** to **1**.
- ▶ Set parameter **P400.02** to **1**.

Use the key to start the motor.

Start/control/stop motor with keypad

1. Press the key to start the motor.
 - The keypad shows the motor speed.
2. Use the key or the key to change the frequency setpoint.
3. Press the key to stop the motor.

Change rotating direction

1. Press the key.
2. Press the key to confirm the reversal of rotating direction.

7.3 Commissioning with the EASY Starter

Commissioning and diagnostics can be carried out with the EASY starter engineering tool. A USB module and a standard USB cable (A plug to micro-B plug) is required for this. <http://www.Lenze.com>

7.4 The most important parameters at a glance

This chapter contains the most important parameters and selections. You can find a detailed description in the commissioning document. <http://www.Lenze.com>

The parameters are divided into the following function groups:

- Pxxx.xx group 0: Favorites
- P1xx.xx group 1: Diagnostics
- P2xx.xx group 2: Basic setting
- P3xx.xx group 3: Motor control
- P4xx.xx group 4: I/O setting
- P5xx.xx group 5: Network setting
- P6xx.xx group 6: Process controller
- P7xx.xx group 7: Additional functions
- P8xx.xx group 8: Sequencer

7.4.1 Group 0: Favorites

Group 0 contains the configurable favorites that are also contained in the groups 1 to 8. In the default setting these are the most common parameters for the solution of typical applications.

Display code	Designation	Possible settings/value ranges	Keypad code	Information
P100.00	Output frequency	x.x Hz (read only)		Display of the actual output frequency.
P103.00	Current actual	x.x % (read only)		Display of the actual motor current.
P106.00	Motor voltage	x VAC (read only)		Display of the actual motor voltage.
P150.00	Error code	- (read only)		Error message.
P200.00	Control selection	Flexible I/O	[0]	This selection enables a flexible assignment of the start, stop, and rotating direction commands with digital signal sources.
		Keypad	[1]	This selection enables the motor to start exclusively via the start key of the keypad. Other signal sources for starting the motor are ignored.
P201.01	F-setp.source	Keypad	[1]	The setpoint is specified locally by the keypad.
		Analog input 1	[2]	The setpoint is defined as analog signal via the analog input 1.
		Analog input 2	[3]	The setpoint is defined as analog signal via the analog input 2.
		HTL input	[4]	The digital inputs DI3 and DI4 can be configured as HTL input to use an HTL encoder as setpoint encoder or define the setpoint as a reference frequency ("pulse train").
		Network	[5]	The setpoint is defined as process data object via the network.
		Frequency preset 1 ... 15	[11] ... [25]	For the setpoint selection, "preset" values can be parameterized and selected. All frequency presets are described in detail in the commissioning manual. http://www.Lenze.com
P203.01	Start method	Normal	[0]	After start command, the standard ramps are active.
		DC braking	[1]	After start command, the "DC braking" function is active for the time set in P704.02.
		Flying restart circuit	[2]	After the start command, the flying restart circuit is active.
		Premagnetization	[3]	After start command, the standard ramps are active and the premagnetization of the motor is activated. This reduces the motor current and smoothes the acceleration curve during the starting process (only relevant in the V/f motor control mode).

Display code	Designation	Possible settings/value ranges	Keypad code	Information
P203.03	Stop method	Coasting	[0]	The motor has no torque (coasts down to standstill).
		Standard ramp	[1]	The motor is brought to a standstill with the deceleration time 1 P221.00 (or deceleration time 2 P223.00 if activated).
		Quick stop ramp	[2]	The motor is brought to a standstill with the deceleration time (P225.00) set for the "quick stop" function.
		Switch-off positioning	[3]	Is similar to the stop method "standard ramp [1]". Depending on the actual output frequency, however, the inverter delays the beginning of the down-ramping so that the number of motor revolutions until a standstill is reached and thus the stopping position is always relatively constant.
P208.01	Mains voltage	230 Veff	[0]	Selection of the mains voltage for actuating the inverter.
		400 Veff	[1]	
		480 Veff	[2]	
		120 Veff	[3]	
P210.00	Min. frequency	0.0 ... 599.0 Hz		Lower limit value for all frequency setpoints.
P211.00	Max. frequency	Device for 50-Hz mains: 50 Hz * Device for 60-Hz mains: 60 Hz *		Upper limit value for all frequency setpoints.
P220.00	Acceleration 1	0.0 ... 5.0 ... 3600.0 s		Acceleration time 1.
P221.00	Deceleration 1	0.0 ... 5.0 ... 3600.0 s		Deceleration time 1
P300.00	Motor ctrl mode	Servo control (SC ASM)	[2]	This control mode is used for servo control of an asynchronous motor. This motor control mode is described in the commissioning manual. http://www.Lenze.com
		Sensorless control (SL PSM)	[3]	This control type is used for the sensorless control of a synchronous motor. This motor control mode is described in the commissioning manual. http://www.Lenze.com
		Sensorless vector control (SLVC)	[4]	This control type is used for sensorless vector control of an asynchronous motor. For this purpose, observe the parameters P327.04 and P327.05 for identifying and calibrating the motor.
		VFC open loop	[6]	This control mode is used for the speed control of an asynchronous motor via a V/f characteristic and is the simplest control mode.
		V/f characteristic control (VFC closed loop)	[7]	The control mode is used for speed control of an asynchronous motor via a V/f characteristic with speed feedback. This motor control mode is described in the commissioning manual. http://www.Lenze.com
P302.00	V/f characteristic shape	Linear	[0]	Linear characteristic for drives with constant load torque over the speed.
		Square-law	[1]	Square-law characteristic for drives with a square-law load torque over the speed.
		Eco	[3]	Linear characteristic with energy optimization in the partial load operational range.
P303.01	Base voltage	0 ... 230 ... 5000 V *		Base voltage and base frequency define the V/f ratio and thus the gradient of the V/f characteristic. <ul style="list-style-type: none"> The V/f base voltage is usually set to the rated motor voltage. The V/f base frequency is usually set to the rated motor frequency.
P303.02	Base frequency	Device for 50-Hz mains: 50 Hz * Device for 60-Hz mains: 60 Hz *		Base voltage and base frequency define the V/f ratio and thus the gradient of the V/f characteristic. <ul style="list-style-type: none"> The V/f base voltage is usually set to the rated motor voltage. The V/f base frequency is usually set to the rated motor frequency.
P304.00	Limitation of rotation	Only clockwise (CW)	[0]	The motor can only be rotated clockwise (CW). The transfer of negative frequency and PID setpoints to the motor control is prevented.
		Both rotation directions	[1]	Both directions of motor rotation are enabled.
P305.00	Switching frequency	8 kHz var/opt/4 *		Selection of the inverter switching frequency.
P306.01	Overload selection	Heavy duty	[0]	Load characteristic for high dynamic requirements.
		Light duty	[1]	Load characteristic for low dynamic requirements.
P308.01	Max. load for 60s	30 ... 150 ... 200 %		Maximum permissible thermal motor utilization (max. permissible motor current for 60 seconds). With regard to rated motor current (P323.00)
P316.01	Fixed V/f boost	0.0 ... 2.5 ... 20.0 % *		Constant voltage boost for the V/f characteristic control without feedback.

Display code	Designation	Possible settings/value ranges	Keypad code	Information
P323.00	Motor current	0.001 ... 1.700 ... 500.000 A *		Setting of the rated motor current according to motor nameplate.
P324.00	Max current	0.0 ... 200.0 ... 3000.0 %		Maximum overload current of the inverter.
P400.01	Inverter enable	TRUE	[1]	Assignment of a trigger to the “inverter enable” function. Trigger = TRUE: The inverter is enabled (unless there is another cause for inverter disable). Trigger = FALSE: The inverter is disabled. The motor has no torque and coasts.
P400.02	Run	Digital input 1	[11]	Assignment of a trigger to the “Run” function. Function 1: Start / stop motor (default setting) Function 1 is active if no further start commands (start forward/start reverse) have been connected to triggers, no keypad control is active and no network control is active. Trigger = TRUE Let motor rotate forward (CW). Trigger = FALSE: Stop motor according to stop function (P203.03). Function 2: Start enable/stop motor Function 2 is active if further start commands have been connected to triggers, the keypad control is active or the network control is active. Trigger = TRUE: Start commands of the active control source are enabled. Trigger = FALSE: Stop motor.
P400.03	Quick stop	Not connected	[0]	Assignment of a trigger to the “Activate quick stop” function. Trigger = TRUE: Activate quick stop. Quick stop ramp P225.00. Trigger = FALSE: Deactivate quick stop
P400.04	Error reset	Digital input 2	[12]	Assignment of a trigger to the “Reset error” function. Trigger = FALSE > TRUE (edge): Active error is reset (acknowledged) if the error condition is not active anymore and the error is resettable. Trigger = FALSE: No action.
P400.05	DC braking	Not connected	[0]	Assignment of a trigger to the “Activate DC braking” function. Trigger = TRUE: Activate DC braking. Trigger = FALSE: Deactivate DC braking.
P400.06	Start forward	Not connected	[0]	Assignment of a trigger to the “Start forward (CW)” function. Trigger = FALSE > TRUE (edge): Let motor rotate forward. Trigger = TRUE > FALSE (edge): No action. Stop via P400.01 (default setting of digital input 1).
P400.07	Start reverse	Not connected	[0]	Assignment of a trigger to the “Start reverse (CCW)” function. Trigger = FALSE > TRUE (edge): Let motor rotate backward. Trigger = TRUE > FALSE (edge): No action. Stop via P400.01 (default setting of digital input 1).
P400.08	Run forward	Not connected	[0]	Assignment of a trigger to the “Run forward (CW)” function. Trigger = TRUE: Let motor rotate forward. Trigger = FALSE: Stop motor. Stop via P400.01 (default setting of digital input 1).
P400.09	Run reverse	Not connected	[0]	Assignment of a trigger to the “Run reverse (CCW)” function. Trigger = TRUE: Let motor rotate backward. Trigger = FALSE: Stop motor. Stop via P400.01 (default setting of digital input 1).
P400.13	Reverse rot. dir.	Digital input 3	[13]	Assignment of a trigger to the “Reverse rotating direction” function. Trigger = TRUE: The setpoint specified is inverted (i.e. the sign is inverted). Trigger = FALSE: No action / deactivate function again.

Display code	Designation	Possible settings/value ranges	Keypad code	Information
P400.18	Setp: Preset B0	Digital input 4	[14]	Assignment of a trigger to the "Activate preset (bit 0)" function. Bit with the valency 20 for the bit-coded selection and activation of a parameterized setpoint (preset value). Trigger = FALSE: Bit = "0". Trigger = TRUE: Bit = "1".
P400.19	Setp: Preset B1	Digital input 5	[15]	Assignment of a trigger to the "Activate preset (bit 1)" function. Bit with the valency 21 for the bit-coded selection and activation of a parameterized setpoint (preset value). Trigger = FALSE: Bit = "0". Trigger = TRUE: Bit = "1".
P400.20	Setp: Preset B2	Not connected	[0]	Assignment of a trigger to the "Activate preset (bit 2)" function. Bit with the valency 22 for the bit-coded selection and activation of a parameterized setpoint (preset value). Trigger = FALSE: Bit = "0". Trigger = TRUE: Bit = "1".
P420.01	Relay function	Running	[50]	TRUE if inverter and start are enabled and output frequency > 0.2 Hz. Otherwise FALSE.
		Ready for operation	[51]	TRUE if inverter is ready for operation (no error active, no STO active and DC-bus voltage ok). Otherwise FALSE.
		Operation enabled	[52]	TRUE if inverter and start are enabled. Otherwise FALSE.
		Stop active	[53]	TRUE if inverter is enabled and motor is not started and output frequency = 0.
		Error active	[56]	TRUE if error is active. Otherwise FALSE.
		Device warning active	[58]	TRUE if warning is active. Otherwise FALSE.
P420.02	DO1 function	Release brake	[115]	Assignment of a trigger to digital output 1. Trigger = FALSE: X3/DO1 set to LOW level. Trigger = TRUE: X3/DO1 set to HIGH level.
P430.01	AI1 input area	0 ... 10 V DC	[0]	Definition of the input range.
		0 ... 5 V DC	[1]	
		2 ... 10 V DC	[2]	
		-10 ... +10 V DC	[3]	
		4 ... 20 mA	[4]	
		0 ... 20 mA	[5]	
P430.02	AI1 freq @ min	- 1000.0 ... 0.0 ... 1000.0 Hz		Definition of the setting range for AI1. <ul style="list-style-type: none"> Rotating direction according to sign. The standard setpoint source for operating mode is selected in P201.01.
P430.03	AI1 freq @ max	50.0 Hz * 60.0 Hz *		Definition of the setting range for "MS: Velocity mode". <ul style="list-style-type: none"> Rotating direction according to sign. The standard setpoint source for operating mode is selected in P201.01.
P440.01	AO1 output area	Inhibited	[0]	Definition of the output range.
		0 ... 10 V DC	[1]	
		0 ... 5 V DC	[2]	
		2 ... 10 V DC	[3]	
		4 ... 20 mA	[4]	
		0 ... 20 mA	[5]	

Display code	Designation	Possible settings/value ranges	Keypad code	Information
P440.02	AO1 function	Output frequency	[1]	Actual output frequency (resolution: 0.1 Hz).
		Frequency setpoint	[2]	Actual frequency setpoint (resolution: 0.1 Hz).
		Analog input 1	[3]	Input signal of analog input 1 (resolution: 0.1 %).
P440.03	AO1 min. Signal	-2147483648 ... 0 ... 2147483647		Definition of the signal value that corresponds to the minimum value at analog output 1.
P440.04	AO1 max. signal	-2147483648 ... 1000 ... 2147483647		Definition of the signal value that corresponds to the maximum value at analog output 1.
P450.01	Freq. preset 1	0.0 ... 20.0 ... 599.0 Hz		Parameterizable frequency setpoints (preset 1).
P450.02	Freq. preset 2	0.0 ... 40.0 ... 599.0 Hz		Parameterizable frequency setpoints (preset 2).
P450.03	Freq. preset 3	0.0 ... 50.0 – 40.0 ... 599.0 Hz *		Parameterizable frequency setpoints (preset 3).
P450.04	Freq. preset 4	0.0 ... 0.0 ... 599.0 Hz		Parameterizable frequency setpoints (preset 4).
* Default setting dependent on the model				

7.4.2 Group 2: Basic setting

Display code	Designation	Possible settings	Keypad code	Information
P225.00	Quick stop deceleration time	1.0 s		<p>Quick stop deceleration time for "MS: Velocity mode"</p> <ul style="list-style-type: none"> If the "Quick stop" function is activated, the motor is brought to a standstill within the deceleration time set here. The deceleration time set refers to the deceleration from the maximum frequency set (P211.00) to standstill. In the case of a lower actual frequency, the actual deceleration time is reduced accordingly. Setting is not effective in the operating mode P301.00 = "CiA:Velocity mode".

7.4.3 Group 3: Motor control

Display code	Designation	Possible settings	Keypad code	Information
P320.04	Rated speed	50 ... 50000 rpm		General motor data.
P320.05	Rated frequency	1.0 ... 10000.0 Hz		Carry out settings as specified by motor nameplate data.
P320.06	Rated power	0.00 ... 655.35 kW		Note!
P320.07	Rated voltage	0 ... 65535 V		When you enter the motor nameplate data, take into account the phase connection implemented for the motor (star or delta connection). Only enter the data applying to the connection type selected.
P320.08	Cos phi	0.00 ... 1.00		
P327.04	Identify motor data	0 ... 1		<p>1 = start automatic identification of the motor data.</p> <ul style="list-style-type: none"> Inverter characteristics, motor equivalent circuit diagram data and controller settings are identified and set automatically. During the procedure, the motor is energized!
P327.05	Calibrate motor data (non-energized)	0 ... 1		<p>1 = start automatic calibration of the motor data.</p> <ul style="list-style-type: none"> A default inverter characteristic is loaded. The motor equivalent circuit diagram data and controller settings are calculated on the basis of the currently set rated motor data. The motor is not energized.

7.4.4 Group 7: Additional functions

Display code	Designation	Possible settings	Keypad code	Information
P700.01	Device commands: Load default settings	Off / ready	[0]	Only status feedback
		On / start	[1]	<p>1 = reset all parameters in the RAM memory of the inverter to the default setting that is stored in the inverter firmware.</p> <ul style="list-style-type: none"> All parameter changes made by the user are lost during this process! This process may take some seconds. When the device command has been executed successfully, the value 0 is shown. Loading parameters has a direct effect on cyclic communication: The data exchange for control is interrupted and a communication error is generated.
P700.03	Save USER data	Off / ready	[0]	<p>1 = save current parameter settings in the user memory of the memory module with mains failure protection.</p> <ul style="list-style-type: none"> It may take some seconds to execute the task. When the device command has been executed successfully, the value 0 is shown. Do not switch off the supply voltage during the saving process and do not unplug the memory module from the inverter! When the inverter is switched on, all parameters are automatically loaded from the user memory of the memory module to the RAM memory of the inverter.
		On / start	[1]	
		In progress	[2]	
		Action cancelled	[3]	
		No access	[4]	
No access (Inverter disabled)	[5]			

8 Troubleshooting

8.1 Error message

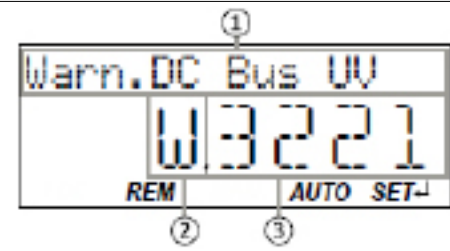

If an error is pending, the keypad shows the following information.

	1 = error text	
	2 = error type	F = fault
		T = trouble
		W = warning
3 = error code (hexadecimal)		
Faults (F) and trouble (T) are displayed continuously. The inverter is disabled.		
Warnings (W) are displayed every 2 seconds for a short time. The inverter is probably disabled.		

8.2 Reset error

Reset error via keypad

Errors can be reset via the  key if the cause of the error has been eliminated and no blocking time is active.

- ▶ Press the  key to reset the error. The motor is stopped.
- ▶ Press the  key to reset the stop.

Reset error via terminal control

When terminal control is used, errors can be reset in 2 ways:











1. Via start signal **P400.02** (default setting of digital input 1).
 - Cause of error has been eliminated and no blocking time is active.
 - The signal at the digital input 1 (**P400.02**) must drop and then be applied again.
2. Via **P400.04** (default setting of digital input 2).
 - Cause of error has been eliminated and no blocking time is active.
 - The error is reset if a signal is applied to digital input 2 (**P400.04**).

8.3 Error codes

Error code	Description	Classification	Remedy	Blocking time [s]	Reset possible
2250	CiA: Continuous overcurrent (inside the device)	Fault	<ul style="list-style-type: none"> • Check motor and wiring for short circuit. • Check brake resistor and wiring. • Check motor circuit (delta connection, star connection). • Check setting of the motor data. 	5	Yes
2320	Short circuit or earth leakage on the motor side	Fault	<ul style="list-style-type: none"> • Check motor cable. • Check the length of the motor cable. • Use shorter or lower-capacitance motor cable. 	5	Yes
2340	CiA: Short circuit (inside the device)	Fault	<ul style="list-style-type: none"> • Check motor cable for short circuit. 	5	Yes
2350	CiA: $i^2 \cdot t$ overload (thermal state)	Fault	<ul style="list-style-type: none"> • Check drive sizing. • Check machine/driven mechanics for excessive load. • Check setting of the motor data. • Reduce values for slip compensation (P315.01, P315.02) and oscillation damping (P318.01, P318.02). 	5	Yes
2382	Error: Device utilisation (lxt) too high	Fault	<ul style="list-style-type: none"> • Check drive sizing. • Reduce maximum overload current of the inverter (P324.00). • In case of high mass inertias, reduce maximum overload current of the inverter (P324.00) to 150 %. 	3	Yes
2383	Warning: Device utilisation (lxt) too high	Warning	<ul style="list-style-type: none"> • Check drive sizing. 	0	Yes
3120	Mains phase fault	Fault	<ul style="list-style-type: none"> • Check wiring of the mains connection • Check fuses. 	0	Yes
3210	DC bus overvoltage	Fault	<ul style="list-style-type: none"> • Reduce dynamic performance of the load profile. • Check mains voltage. • Check settings for braking energy management. • Connect brake resistor to the power unit and activate the integrated brake chopper. (P706.01 = 0: brake resistance). 	0	Yes
3211	Warning: DC bus overvoltage	Warning	<ul style="list-style-type: none"> • Reduce dynamic performance of the load profile. • Check mains voltage. • Check settings for braking energy management. • Connect brake resistor to the power unit and activate the integrated brake chopper. (P706.01 = 0: brake resistance). 	0	Yes
3220	DC bus undervoltage	Trouble	<ul style="list-style-type: none"> • Check mains voltage. • Check fuses. • Check DC-bus voltage (P105.00). • Check mains settings. 	0	Yes
3221	Warning: DC bus undervoltage	Warning	<ul style="list-style-type: none"> • Check mains voltage. • Check fuses. • Check DC-bus voltage. • Check mains settings. 	0	Yes
3222	DC-bus voltage too low for switch-on	Warning	<ul style="list-style-type: none"> • Check mains voltage. • Check fuses. • Check mains settings. 	0	Yes
4210	PU: Overtemperature fault	Fault	<ul style="list-style-type: none"> • Check mains voltage. • Provide for a sufficient cooling of the device (display of the heatsink temperature in P117.01). • Clean fan and ventilation slots. If required, replace fan. • Reduce switching frequency (P305.00). 	0	Yes
4281	Heatsink fan warning	Warning	<ul style="list-style-type: none"> • Clean fan and ventilation slots. If required, replace fan. The fans can be unlocked via locking hooks and can then be removed. 	0	Yes
4310	Error: Motor overtemperature	Fault	<ul style="list-style-type: none"> • Check drive sizing. • Check motor temperature sensor and wiring (X109/T1 and X109/T2). 	5	Yes

Error code	Description	Classification	Remedy	Blocking time [s]	Reset possible
5112	24 V supply fault	Warning	<ul style="list-style-type: none"> Check optional external 24V voltage supply (terminal X3/24E), if connected. Check mains voltage. 	0	Yes
5180	24-V supply overload	Warning	<ul style="list-style-type: none"> Check 24-V output and digital outputs for earth fault or overload. 	0	Yes
6280	Trigger/functions connected incorrectly	Trouble	<ul style="list-style-type: none"> Check and correct the assignment of the triggers to the functions. With keypad or network control, the two functions "Inverter enable" (P400.01) and "Run" (P400.02) can also be set to "Constant TRUE [1]" to start the motor. 	0	Yes
7180	Motor overcurrent	Fault	<ul style="list-style-type: none"> Check motor load. • Check drive sizing. Adapt the set error threshold (P353.01). 	1	Yes
9080	Keypad removed	Fault	<ul style="list-style-type: none"> Plug on the keypad again or activate another control source. 	0	Yes
FF02	Error: Brake resistor overload	Fault	<ul style="list-style-type: none"> Check drive sizing. Check settings for the braking energy management. <p>Note: The error will be reset if the thermal load falls below the error threshold (P707.09) of - 20 %.</p>	5	Yes
FF06	Motor overspeed	Fault	<ul style="list-style-type: none"> Adapt the maximum motor speed (P322.00) and the error threshold (P350.01). 	1	Yes
FF36	Warning: Brake resistor overload	Warning	<ul style="list-style-type: none"> Check drive sizing. Check settings for the braking energy management. <p>Note: The warning will be reset if the thermal load falls below the warning threshold (P707.08) of - 20 %.</p>	0	Yes
FF37	Automatic start disabled	Fault	<ul style="list-style-type: none"> Deactivate start command and reset error. 	0	Yes
FF85	Keypad full control active	Warning	<ul style="list-style-type: none"> To exit the control mode, press the  keypad key. 	0	Yes

8.4 LED status

LED "RDY" (blue)	LED "ERR" (red)	Status/meaning
off	off	No supply voltage.
		Mains voltage is switched on, inverter is initialized.
 flashes	off	Inverter is disabled, ready for operation.
	 flashes	Safe torque off (STO) active, warning active.
 flashes	off	Inverter inhibited.
	 flashes fast	Inverter disabled, warning active.
		Inverter disabled, error active.
	 every 1.5 s on	Inverter disabled, no DC-bus voltage.
	off	Inverter enabled.
	off	The motor rotates according to the specified setpoint or quick stop active.
	 flashes fast	Inverter enabled, warning active. The motor rotates according to the specified setpoint or quick stop active.
	 flashes	Inverter enabled, quick stop as response to fault active.

9 Further documents

For certain tasks, information is available in further documents.

Document	Contents/topics
Project Planning document	Fundamental information on project planning and ordering the product
Commissioning document	Fundamental information for the installation and commissioning of the product
Mounting instructions	Fundamental information on mounting the product

The documents can be found in the [Lenze Doc Finder](#).

10 Disposal

If pollutants are disposed off improperly, they may cause a lasting damage to human health and the environment. Thus, electrical and electronic equipment must be collected separately from unsorted municipal waste so that it may be recycled or disposed of properly.

If available, put the components to the company internal disposal from where it is passed on to specialized waste management companies.

It is also possible to return the components to the manufacturer. For this purpose, please contact the customer service of the manufacturer.

More detailed information on disposal can be obtained from the corresponding specialist firms and the competent authorities.

The packaging of the component must be disposed of separately. Paper, cardboard and plastics must be recycled.

11 Glossary

Abbreviation	Meaning
AIE	Error acknowledgement ("Acknowledge In Error")
OFF state	Signal status of the safety sensor when it triggers or responds
QSP	Quick stop

© 01/2020 | 3.0

Lenze Drives GmbH
Postfach 10 13 52, 31763 Hameln
Breslauer Straße 3, 32699 Extertal
GERMANY
HR Lemgo B 6478
Phone: +49 5154 82-0
Fax: +49 5154 82-2800
E-mail: Sales.de@Lenze.com
Web: www.Lenze.com

Lenze Service GmbH
Breslauer Straße 3, 32699 Extertal
GERMANY
Phone: 0080002446877 (24 h Helpline)
Fax: +49 5154 82-1112
E-mail: Service.de@Lenze.com

Lenze