



TERMINAL

Optimale Lösungen für industrielle Beleuchtung und Leitungsführung – sowohl im Elektroinstallationshandwerk, als auch im Maschinen- und Schaltschrankbau.

Diesem Anspruch wird LICATEC als inhabergeführtes mittelständisches Unternehmen mit hoher Flexibilität und kurzen Entscheidungswegen schon seit mehr als 40 Jahren gerecht.

Wir entwickeln und produzieren innovative und montagefreundliche Systeme, um unseren Kunden die Arbeit zu erleichtern.

Über unser gut ausgebautes internationales Vertriebsnetz gewährleisten wir die kompetente Beratung vor Ort, unsere Zentrallogistik sichert die schnelle und termingerechte Belieferung, oft bis direkt auf die Baustelle.

Weltweit vertrauen, mit weiterhin stark steigender Tendenz, bereits mehr als 5000 Kunden unseren Produkten und unserem Service – für uns ein großer Ansporn, den eingeschlagenen Weg konsequent weiter zu verfolgen.

Alle technischen Daten, Abbildungen und Preisangaben wurden sorgfältig erstellt. Irrtümer vorbehalten. Technische Änderungen, die der Weiterentwicklung dienen, behalten wir uns vor.

Unverbindliche Richtpreise ohne Mehrwertsteuer

Unsere Lieferungs- und Zahlungsbedingungen finden Sie im Internet unter www.licatec.de/agb.

The provision of optimal solutions for industrial lighting and cable conduit systems – both in the electrical installation trade and in mechanical engineering and switch cabinet construction.

The owner-managed medium-sized company LICATEC has been meeting these requirements for more than 40 years with its high degree of flexibility and short decision-making paths.

We develop and produce innovative and easy to install systems which make our client's work easier.

Our well-developed international sales network enables us to guarantee competent local advice and our central logistics secures the fast on time delivery, often onto the construction site.

More than 5000 customers place their trust in our products and our service, and that with a growing tendency – this is a great motivation for us to consistently continue along this road.

All technical data and illustrations have been prepared with care. Errors excepted. We reserve the right to make any technical modifications which serve further development.

Not binding suggested prices excl. VAT

Please see www.licatec.de/agb for reference regarding our Terms of Delivery and Payment.

Allgemeine Merkmale / General features Terminal	4-5
Terminal F 2000	6-7
Terminal F 2000 halogenfrei / halogen-free	8-9
Terminal DIN	10-11
Terminal DIN halogenfrei / halogen-free	12-13
Terminal Safety	14-15
Terminal Zubehör	16-19



Terminal

Verdrahtungskanäle / Control Panel Trunkings

Allgemeine Merkmale:

- optimaler Deckelsitz, leichte Montage und Demontage
- Sollbruchstellen an den Stegen und am Kanalboden
- Einsatz von Trennstegen möglich
- Bodenlochung nach DIN, Stanzbild bei jeder Länge identisch
- Gratfrei geprägt - keine Verletzungsgefahr für den Monteur und die Kabel
- Lieferlänge: 2 m, mit Deckel
- Fixlängen: auf Anfrage
- alle Abmessungen auch ohne Stanzungen lieferbar

Optimaler Deckelsitz
Ideal fit of cover

Gratfrei geprägt
Keine Verletzungsgefahr für
den Monteur und die Kabel
Smooth fingers
Will not hurt the installer
or damage the cables

Sollbruchstellen an den Stegen
Notch points at the slids of trunking

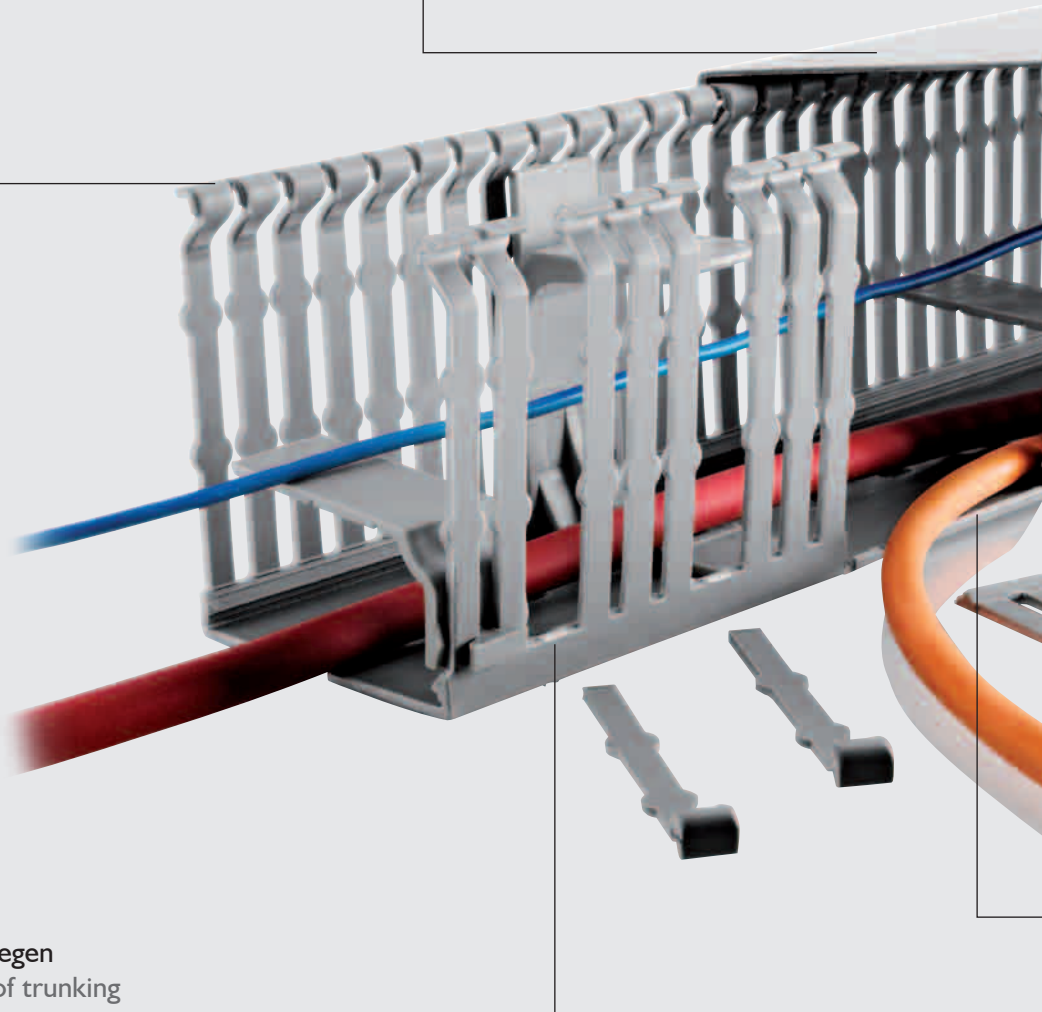

General Features:

- ideal fit of cover, easy assembly and disassembly.
- notch points at the slids and base of trunkings
- use of dividers possible
- perforated base according to DIN, identical punch picture for each length
- Smooth fingers - will not hurt the installer or damage the cables
- delivery length: 2 m, with cover
- fixed lengths: on request
- all dimensions can be supplied without punches

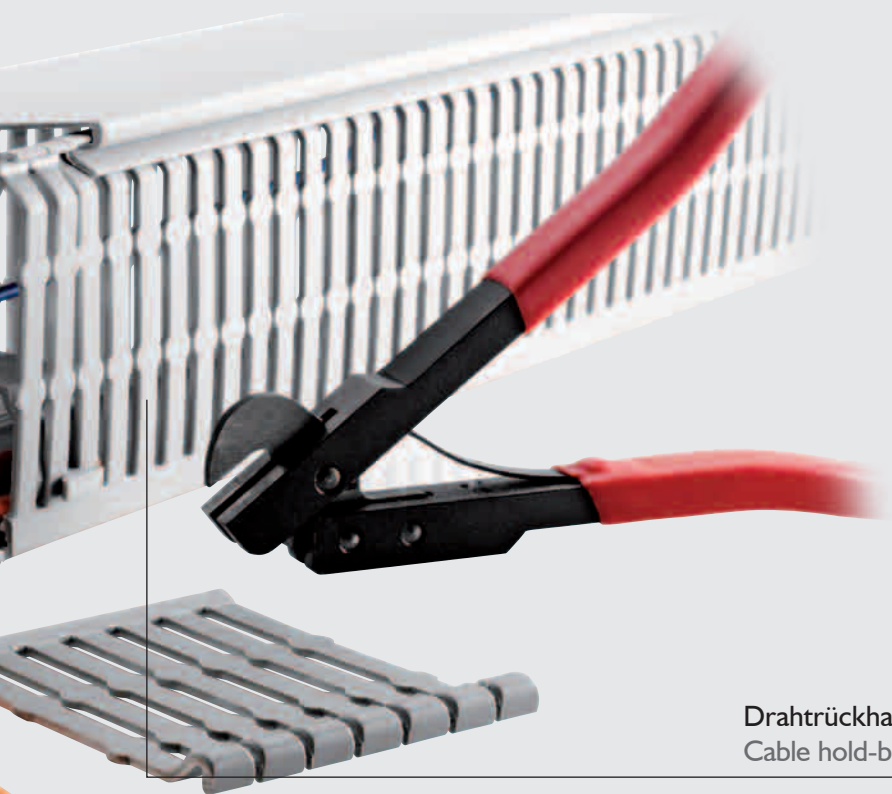

Drahrückhaltenasen
Cable hold-back noses



Sollbruchstellen am Kanalboden
Notch points at the base of trunking

Terminal F 2000

Verdrahtungskanäle / Control Panel Trunkings



RoHS



Bureau Veritas



Underwriter Laboratories UL



EPLAN

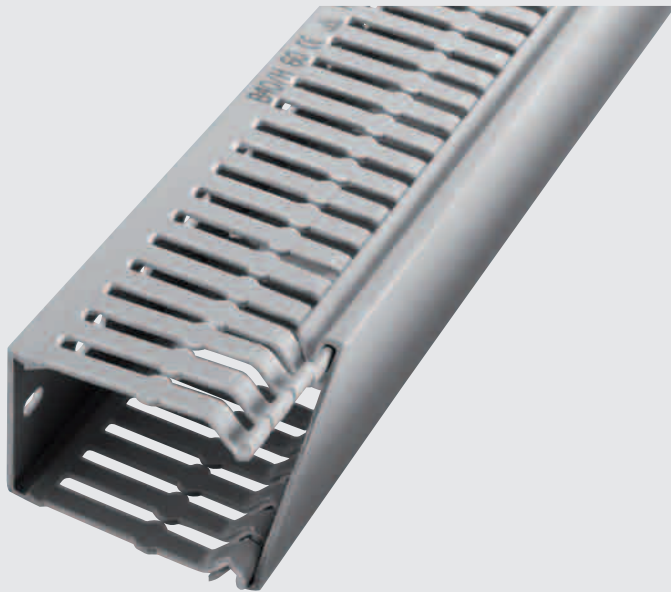

Material: Hart-PVC bleifrei, schwer entflammbar, entsprechend UL 94V0, selbstverlöschend, temperaturbeständig -20° C bis +60° C.

Besondere Merkmale:

- Deckelkontur 90°
- Drahrückhaltenasen ab der Bauhöhe 60 mm
- Farbe: grau, RAL 7030

Material: rigid-PVC, lead-free, hard to inflame, according to UL 94V0 self-extinguishing, temperature-resistant -20° C up to + 60° C.

Specific Features:

- cover contour 90°
- cable hold-back noses from installation height 60 mm onwards
- colour: grey, RAL 7030

Bauhöhe 30/40

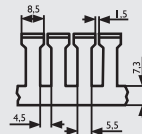

Bauhöhe 80

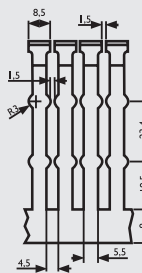

Bauhöhe 120

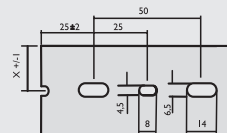
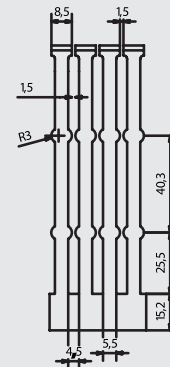

Bis Breite 60 mm

Up to width 60 mm

Bauhöhe 60

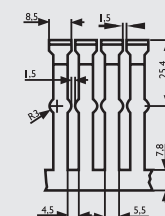

Bauhöhe 100

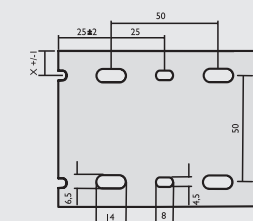
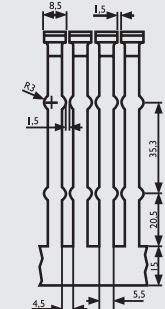

Ab Breite 80 mm

From width 80 mm upwards

Nennmaß Nominal Size B x H/W x H in mm	Innenmaße Interior Dimensions B x H/W x H in mm	Anzahl der Leitungen bei Füllmenge 50 % Quantity of Cables with Filling Capacity of 50 %			Art.-Nr. Art.-No.	VE / m PU / m	€ / m
		0,75 mm ² Ø 2,8	1,0 mm ² Ø 2,9	1,5 mm ² Ø 3,2			
30 x 30	27 x 27	44	41	34	7308-I	64	4,02
25 x 40	22 x 37	53	50	41	7309-I	68	3,95
30 x 40	27 x 37	64	60	49	7310-I	60	4,36
40 x 40	37 x 37	105	98	80	7311-I	52	5,13
60 x 40	56 x 37	164	152	125	7312-I	40	6,19
25 x 60	22 x 56	79	76	61	7319-I	60	5,08
30 x 60	26 x 56	95	92	73	7320-I	52	5,46
40 x 60	36 x 56	162	151	124	7321-I	48	7,06
60 x 60	56 x 56	245	229	188	7322-I	36	8,53
80 x 60	76 x 56	333	310	255	7323-I	32	10,84
100 x 60	96 x 56	417	389	319	7324-I	22	12,74
120 x 60	115 x 56	505	470	387	7325-I	20	14,48
25 x 80	22 x 76	109	101	83	7329-I	56	7,40
30 x 80	26 x 76	131	122	100	7330-I	48	7,91
40 x 80	36 x 76	231	216	177	7331-I	40	9,17
60 x 80	56 x 76	350	326	268	7332-I	36	11,03
80 x 80	76 x 76	475	443	364	7333-I	24	13,36
100 x 80	96 x 76	595	554	455	7334-I	24	14,26
120 x 80	115 x 76	720	670	551	7335-I	16	16,73
30 x 100	26 x 96	160	150	123	7340-I	32	14,24
40 x 100	36 x 96	263	247	202	7343-I	24	15,06
60 x 100	56 x 96	432	406	331	7341-I	32	16,59
80 x 100	76 x 96	585	547	450	7344-I	20	18,57
100 x 100	96 x 96	734	684	562	7342-I	16	20,54
150 x 100	145 x 96	1272	1043	856	7345-I	8	22,28
40 x 120	35 x 116	316	284	238	7351-I	24	17,21
60 x 120	55 x 116	496	447	372	7352-I	24	19,54
80 x 120	75 x 116	676	609	508	7353-I	20	22,54

Deckel / Covers

Nennmaß Nominal Size in mm	Art.-Nr. Art.-No.	VE / m PU / m	€ / m
25	5509-I	10	1,56
30	5510-I	10	1,84
40	5511-I	10	2,07
60	5512-I	10	2,99

Nennmaß Nominal Size in mm	Art.-Nr. Art.-No.	VE / m PU / m	€ / m
80	5513-I	10	3,66
100	5514-I	10	4,86
120	5515-I	10	5,50
150	5021-I	10	8,18

Terminal F 2000 halogenfrei / halogenfree

Verdrahtungskanäle / Control Panel Trunkings



Hergestellt aus UL-gelistetem
Material File-Nr.: 353371
Made of material in accordance
with UL-file-No. 353371

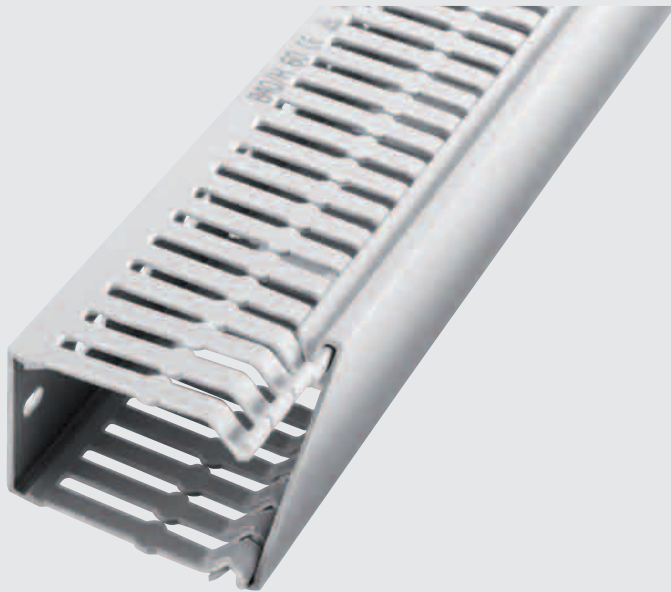

Diese Serie wird aus halogenfreiem Kunststoff gem. VDE 0472, Teil 815 gefertigt. Das Material setzt im Brandfall keine toxischen Gase frei. Temperaturbeständigkeit -25°C bis $+90^{\circ}\text{C}$.

Besondere Merkmale:

- Deckelkontur 90°
- Drahrückhaltenasen ab der Bauhöhe 60 mm
- Farbe: grau, RAL 7035

This series is made of halogen-free plastic, in accordance with VDE 0472, part 815. In case of a fire this material does not set free any toxic gases. Temperature-resistant -25°C up to $+90^{\circ}\text{C}$.

Specific Features:

- cover contour 90°
- cable hold-back noses from installation height 60 mm onwards
- colour: grey, RAL 7035

Bauhöhe 30

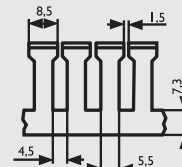

Bauhöhe 60

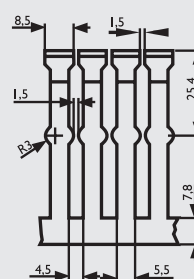

Bauhöhe 100

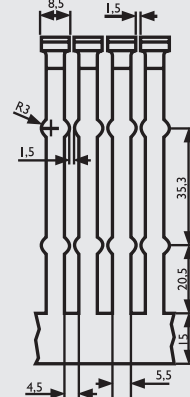

Bauhöhe 40

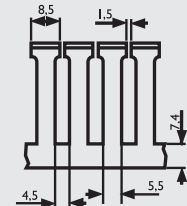

Bauhöhe 80

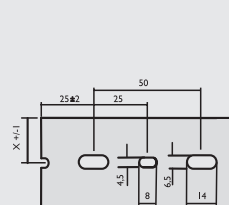
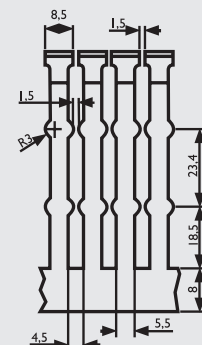

Bis Breite 60 mm

Up to width 60 mm

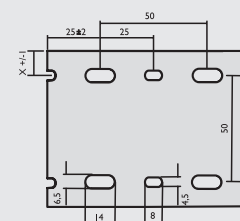

Ab Breite 80 mm

Width 80 mm upwards

Nennmaß Nominal Size B x H/W x H in mm	Innenmaße Interior Dimensions B x H/W x H in mm	Anzahl der Leitungen bei Füllmenge 50 % Quantity of Cables with Filling Cables of 50 %			Art.-Nr. Art.-No.	VE / m PU / m	€/ m
		0,75 mm ² Ø 2,8	1,0 mm ² Ø 2,9	1,5 mm ² Ø 3,2			
30 x 30	27 x 27	44	41	34	7358-I	64	7,48
25 x 40	22 x 37	53	50	41	7359-I	68	8,44
60 x 40	56 x 37	164	152	125	7362-I	40	10,57
25 x 60	22 x 56	79	76	61	7369-I	60	9,79
40 x 60	36 x 56	162	151	124	7371-I	48	12,06
60 x 60	56 x 56	245	229	188	7372-I	36	13,36
80 x 60	76 x 56	333	310	255	7373-I	32	17,49
25 x 80	22 x 76	109	101	83	7379-I	56	13,39
40 x 80	36 x 76	231	216	177	7381-I	40	14,41
60 x 80	56 x 76	350	326	268	7382-I	36	19,84
80 x 80	76 x 76	475	443	364	7383-I	24	22,67
100 x 80	96 x 76	595	554	455	7384-I	24	25,24
60 x 100	56 x 96	432	406	331	7391-I	32	22,67

Deckel Covers

Nennmaß Nominal Size in mm	Art.-Nr. Art.-No.	VE / m PU / m	€/ m
25	5519-I	10	3,01
30	5520-I	10	3,24
40	5521-I	10	3,45

Nennmaß Nominal Size in mm	Art.-Nr. Art.-No.	VE / m PU / m	€/ m
60	5522-I	10	5,01
80	5523-I	10	5,80
100	5524-I	10	6,24

Terminal DIN

Verdrahtungskanäle / Control Panel Trunkings



RoHS



Underwriter Laboratories UL



Licatec Terminal DIN Verdrahtungskanäle, entsprechen EN 50085.

Material: Hart-PVC bleifrei, schwerentflammbar, entsprechend UL 94V0, selbstverlöschend, temperaturbeständig -20° C bis +60° C.

Besondere Merkmale:

- Drahrückhaltenasen ab Bauhöhe 75 mm
- neu: Klebeband K9 als Fixierhilfe am Kanalboden
- Farbe: grau, RAL 7030

Licatec Terminal DIN Control panel trunkings, in accordance with EN 50085.

Material: rigid-PVC, lead-free, hard to inflame, according to UL 94V0 self-extinguishing, temperature-resistant -20° C up to + 60° C.

Specific features:

- cable hold-back noses from height 75 mm onwards
- new: self-adhesive tape K9 as retaining aid on the bottom of the trunking
- colour: grey, RAL 7030

Bauhöhe 25

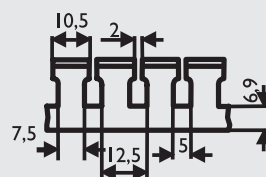

Bauhöhe 37,5

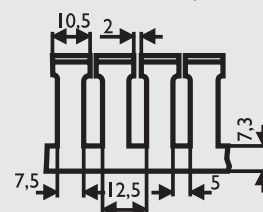

Bauhöhe 50

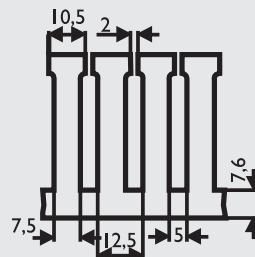

Bauhöhe 75

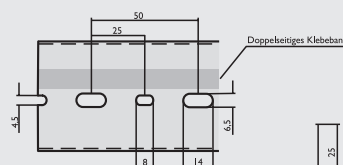
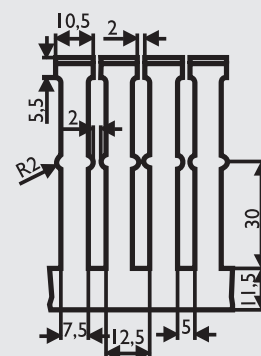

Bis Breite 50 mm

Up to width 50 mm

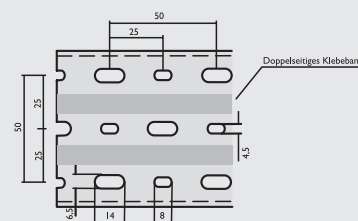

Ab Breite 75 mm

Width 75 mm upwards

Nennmaß Nominal Size B x H/W x H in mm	Innenmaße Interior Dimensions B x H/W x H in mm	Anzahl der Leitungen bei Füllmenge 50 % Quantity of Cables with Filling Cables of 50 %			Art.-Nr. Art.-No.	VE / m PU / m	€/ m
		0,75 mm ² Ø 2,8	1,0 mm ² Ø 2,9	1,5 mm ² Ø 3,2			
25 x 25	20 x 20	32	30	25	7610-I	48	2,40
25 x 37,5	20 x 33	55	55	41	7620-I	54	2,67
37,5 x 37,5	33 x 33	80	75	61	7621-I	40	3,44
50 x 37,5	45 x 33	121	112	92	7622-I	32	4,77
25 x 50	20 x 45	73	68	56	7630-I	44	3,19
37,5 x 50	33 x 45	121	112	92	7631-I	32	4,09
50 x 50	45 x 45	165	153	126	7632-I	42	5,16
75 x 50	70 x 45	256	239	196	7633-I	28	6,16
100 x 50	95 x 45	347	324	266	7634-I	20	8,38
25 x 75	20 x 70	114	109	87	7640-I	36	5,08
37,5 x 75	33 x 70	188	175	144	7641-I	24	5,40
50 x 75	45 x 70	256	239	196	7642-I	28	6,43
75 x 75	70 x 70	398	371	305	7643-I	24	8,38
100 x 75	95 x 70	540	504	414	7644-I	16	9,79
125 x 75	118 x 70	671	625	514	7645-I	16	12,69

Deckel Covers

Nennmaß Nominal Size in mm	Art.-Nr. Art.-No.	VE / m PU / m	€/ m
25	5015-I	48	1,37
37,5	5016-I	24	1,64
50	5017-I	24	1,93

Nennmaß Nominal Size in mm	Art.-Nr. Art.-No.	VE / m PU / m	€/ m
75	5018-I	24	3,17
100	5019-I	12	3,89
125	5020-I	12	4,68

Terminal DIN halogenfrei / halogenfree

Verdrahtungskanäle / Control Panel Trunkings



Hergestellt aus UL-gelistetem
Material File-Nr.: 353371
Made of material in accordance
with UL-file-No. 353371



Licatec Terminal Verdrahtungskanäle DIN entsprechen EN 50085. Diese Serie wird aus halogenfreiem Kunststoff gem. VDE 0472, Teil 815 gefertigt. Das Material setzt im Brandfall keine toxischen Gase frei. Temperaturbeständigkeit -25°C bis $+90^{\circ}\text{C}$.

Besondere Merkmale:

- Drahrückhaltenasen ab Bauhöhe 75 mm
- Farbe: grau, RAL 7035

Licatec Terminal Control panel trunkings DIN, in accordance with EN 50085. This series is made of halogen-free plastic, in accordance with VDE 0472, part 815. In case of a fire this material does not set free any toxic gases. Temperature-resistant -25°C up to $+90^{\circ}\text{C}$.

Specific Features:

- cable hold-back noses from height 75 mm onwards
- colour: grey, RAL 7035

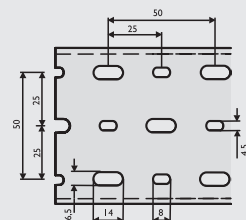
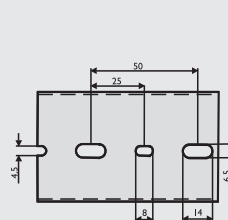
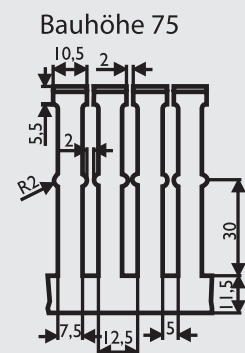
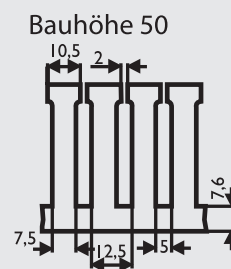
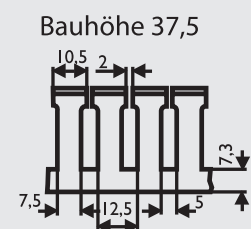
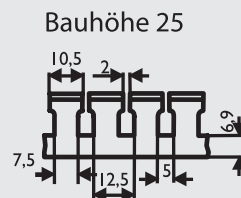

Bis Breite 50 mm
Up to width 50 mm

Ab Breite 75 mm
Width 75 mm upwards

Nennmaß Nominal Size B x H/W x H in mm	Innenmaße Interior Dimensions B x H/W x H in mm	Anzahl der Leitungen bei Füllmenge 50 % Quantity of Cables with Filling Cables of 50 %			Art.-Nr. Art.-No.	VE / m PU / m	€/ m
		0,75 mm ² Ø 2,8	1,0 mm ² Ø 2,9	1,5 mm ² Ø 3,2			
25 x 25	20 x 20	32	30	25	7656-1	48	7,00
25 x 37,5	20 x 33	55	55	41	7650-1	54	7,72
37,5 x 37,5	33 x 33	80	75	61	7651-1	40	7,96
25 x 50	20 x 45	73	68	56	7660-1	44	9,08
37,5 x 50	33 x 45	121	112	92	7661-1	32	9,48
50 x 50	45 x 45	165	153	126	7662-1	42	10,81
75 x 50	70 x 45	256	239	196	7663-1	28	13,87
100 x 50	95 x 45	347	324	266	7664-1	20	17,87
25 x 75	20 x 70	114	109	87	7670-1	36	13,09
37,5 x 75	33 x 70	188	175	144	7671-1	24	13,61
50 x 75	45 x 70	256	239	196	7672-1	28	14,86
75 x 75	70 x 70	398	371	305	7673-1	24	19,09
100 x 75	95 x 70	540	504	414	7674-1	16	22,25
125 x 75	118 x 70	671	625	514	7675-1	16	24,62

Deckel Covers

Nennmaß Nominal Size in mm	Art.-Nr. Art.-No.	VE / m PU / m	€/ m
25	5030-1	48	3,01
37,5	5031-1	24	3,29
50	5032-1	24	4,01

Nennmaß Nominal Size in mm	Art.-Nr. Art.-No.	VE / m PU / m	€/ m
75	5033-1	24	5,13
100	5034-1	12	6,24
125	5035-1	12	7,62

Terminal Safety

Verdrahtungskanäle / Control Panel Trunkings



Licatec Terminal Verdrahtungskanäle Safety sind für die Verwendung in eigensicheren Bereichen vorgesehen und entsprechen der Norm EN 50020.

Material: Hart-PVC bleifrei, schwerentflammbar, entsprechend UL 94V0, selbstverlöschend, temperaturbeständig -20° C bis +60° C.

Besondere Merkmale:

- Drahrückhaltenasen ab Bauhöhe 60 mm
- Farbe: blau, RAL 5015

Licatec Terminal control panel trunkings Safety are intended for the use in separately secured areas and correspond to the regulation EN 50020.

Material: rigid-PVC, lead-free, hard to inflame, according to UL 94V0 self-extinguishing, temperature-resistant -20° C up to + 60° C.

Specific Features:

- cable hold-back noses from height 60 mm onwards
- colour: blue, RAL 5015

Bauhöhe 60

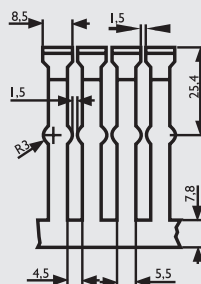

Bauhöhe 100

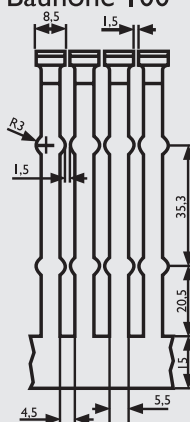

Bauhöhe 80

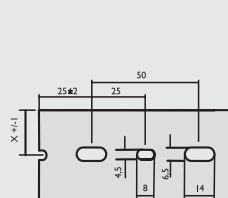
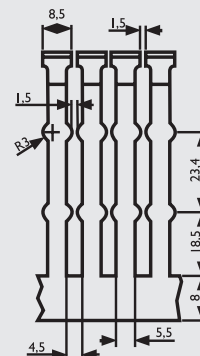

Bis Breite 60 mm
Up to width 60 mm

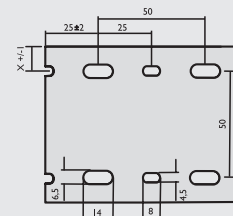

Ab Breite 80 mm
Width 80 mm upwards

Nennmaß Nominal Size B x H/W x H in mm	Innenmaße Interior Dimensions B x H/W x H in mm	Anzahl der Leitungen bei Füllmenge 50 % Quantity of Cables with Filling Cables of 50 %			Art.-Nr. Art.-No.	VE / m PU / m	€/ m
		0,75 mm ² Ø 2,8	1,0 mm ² Ø 2,9	1,5 mm ² Ø 3,2			
40 x 60	36 x 56	162	151	124	7521	48	7,76
60 x 60	56 x 56	245	229	188	7522	36	9,39
80 x 60	76 x 56	333	310	255	7523	32	11,92
30 x 80	26 x 76	131	122	100	7530	48	8,76
40 x 80	36 x 76	231	216	177	7531	40	10,06
60 x 80	56 x 76	350	326	268	7532	36	12,13
80 x 80	76 x 76	475	443	364	7533	24	14,70
100 x 80	96 x 76	595	554	455	7534	24	15,59
60 x 100	56 x 96	432	406	331	7541	32	18,26
100 x 100	96 x 96	734	684	562	7542	16	22,60

Terminal Zubehör / Accessoires

Verdrahtungskanäle / Control Panel Trunkings

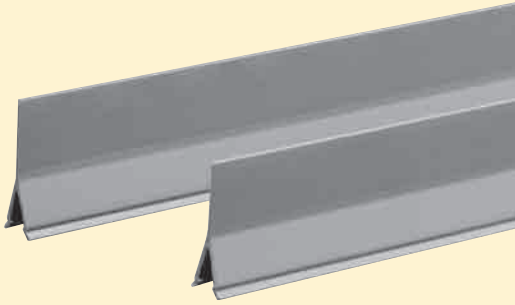

Trennsteg, nur in Verbindung mit Universal-Drathalter
Dividers only in combination with universal wire holders

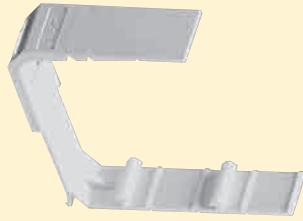

Universal Draht- und Trennsteghalter
Universal wire and divider holder

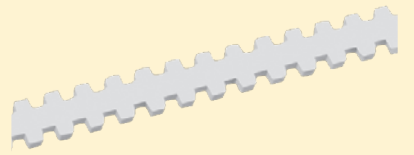

Haltezung
Retaining strip

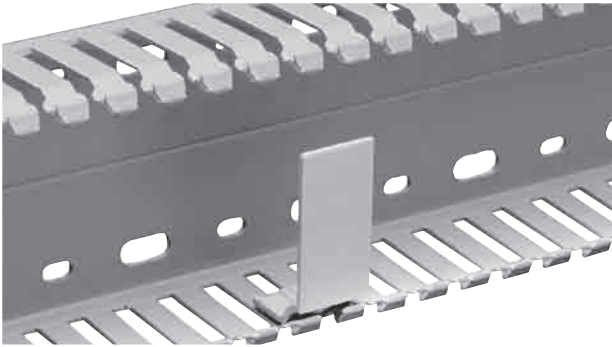

Drathalter Standard
Wire holder standard

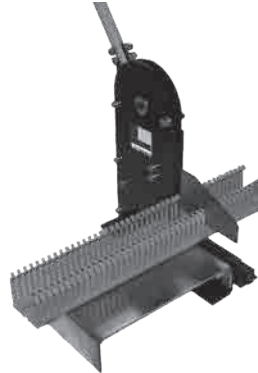

Verdrahtungskanalschneidergerät
Control Panel Trunking Cutting Device

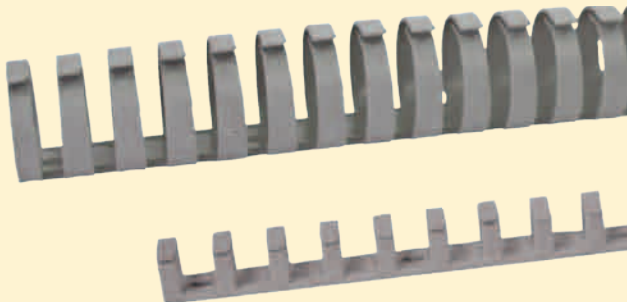

Flexible Verdrahtungskanäle
Flexible wiring ducts

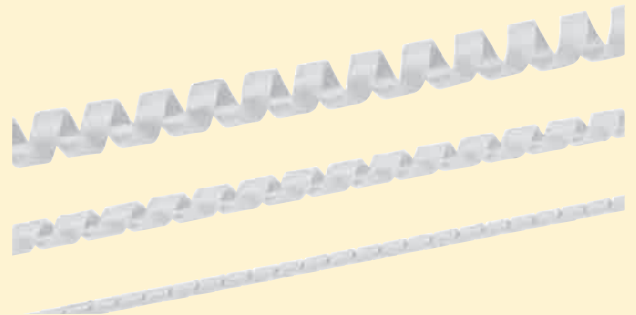

Spiralschläuche
Spiral tubes

Trennstege / Dividers

Abmessungen in mm / Dimensions in mm		Höhe / Height in mm	Materialbeschreibung / Description of Material	Art.-Nr. / Art.-No.	VE / m / PU / m	€ / m
Für Bauhöhe / For Install-height	Länge / Length					
60/75	2000	40	PVC	9053	10	4,30
80/100	2000	60	PVC	8830	10	11,14

Universal Draht- und Trennsteghalter / Universal Wire and Divider Holder

Für	Materialbeschreibung / Description of Material	Einsetzbar ab Breite / Applicable Width	Art.-Nr. / Art.-No.	VE / St. / PU / pcs.	€ / St. / pcs.
F 2000 + Safety	PS	40 mm	7801	50	1,51
DIN + DIN halogenfrei / free	PS	37,5 mm	7804	50	1,51

Drahthalter Standard / Standard Wire Holder

Länge / Length in mm	Materialbeschreibung / Description of Material	Art.-Nr. / Art.-No.	VE / St. / PU / pcs.	€ / St. / pcs.
70	PS	7803	400	0,78

Haltezung PP halogenfrei / Retaining Strip PP halogen-free

Länge / Length in mm	Ø in mm	Art.-Nr. / Art.-No.	VE / St. / PU / pcs.	€ / St. / pcs.
147,5		7802	500	0,50

Verdrahtungskanalschneidergerät / Control Panel Trunking Cutting Device

Art.-Nr. / Art.-No.	Schnittbreite / Cutting Width
7819	max 125 mm

Flex. Verdrahtungskanäle halogenfrei schwerentflammbar UL94VO / Flex. Wiring Ducts halogen-free according to UL94VO self-extinguishing

Länge / Length in mm	Ø in mm	Materialbeschreibung / Description of Material	Art.-Nr. / Art.-No.	VE / St. / PU / pcs.	€ / St. / pcs.
500	10x10	PP	7860-1	100	3,61
500	20	PP	7861-1	60	4,03
500	30	PP	7862-1	36	4,57
500	40	PP	7863-1	24	7,74

Eplan ist ein Konstruktionsprogramm, in dessen Portal jetzt alle Licatec Verdrahtungskanäle hinterlegt sind.

Spiralschläuche halogenfrei / Spiral Tubes halogenfree

Bündelung mm Ø / Bunching mm Ø	Ø in mm	Materialbeschreibung / Description of Material	Einsatztemperatur / Temperature-resistant	Art.-Nr. / Art.-No.	VE / m / PU / m	€ / 100 m.
5 - 20	4	PE	-60° C bis / to +90° C	7806-1	30	93,97
10 - 100	9	PE	-60° C bis / to +90° C	7812-1	30	191,41
20 - 150	16	PE	-60° C bis / to +90° C	7822-1	30	450,10

Terminal Zubehör / Accessoires

Verdrahtungskanäle / Control Panel Trunkings

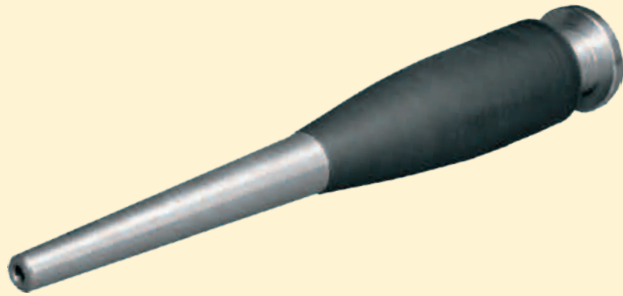

Setzwerkzeug und Spreiznieten
Setting tool and body-bound rivets

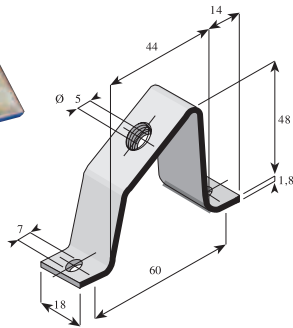
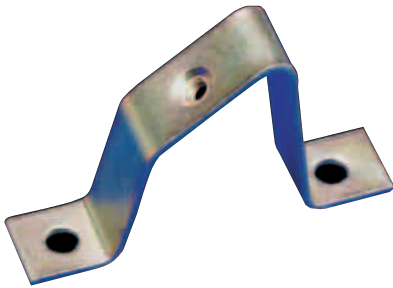

Schrägmontagewinkel
Sloping bracket



Ausklinzange
Cutting pliers

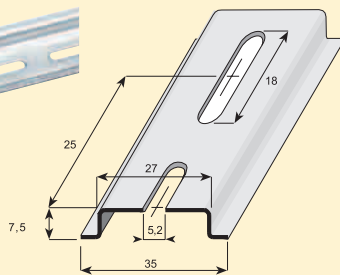
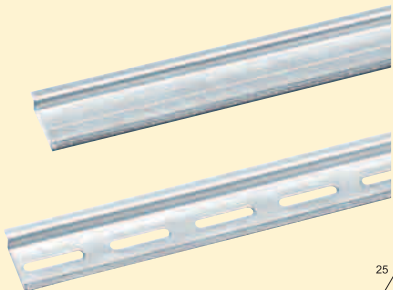

Hutschienen, Höhe 7,5 mm
Top-hat rails, height 7,5 mm

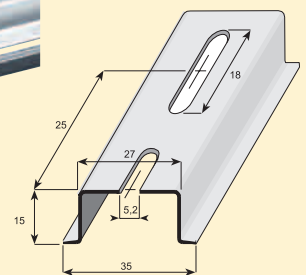
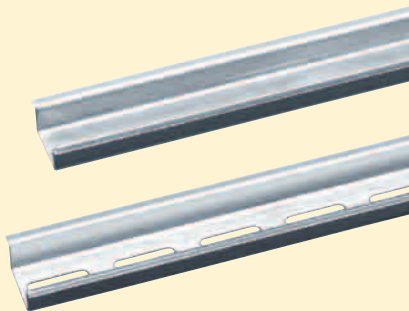

Hutschienen, Höhe 15 mm
Top-hat rails, height 15 mm

Spreiznieten / Body-Bound Rivets

Bohrung Ø mm erforderlich Drilling Ø mm necessary	Ø in mm	Materialbeschreibung Description of Material	Art.-Nr. / Art.-No.	VE / St. / PU / pcs.	€ / 100 St. / pcs.
3,5	3,5	PA	7814	4000	9,27
5,2	5	PA	7815	4000	10,44
6,2	6	PA	7816	4000	10,44
6,5	6,5	PA	7816.5	2000	15,50

Setzwerkzeug / Setting Tool

	Ø in mm	Art.-Nr. Art.-No.	VE / St. PU / pcs.	€ St. / pcs.
für Niete / For rivets	6	7817-1	1	54,21



Ausklinkzange / Cutting Pliers

	Artikel-Nr. Art.-No.	VE/St. PU/pcs.	€ / St. / pcs.
	7880-1	1	110,26

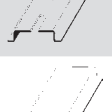

Schrägmontagewinkel / Sloping Bracket

Breite / Width in mm	Höhe / Height in mm	Ø in mm	Materialbeschreibung Description of Material	Artikel-Nr. / Art.-No.	VE/St. / PU/ pcs.	€ / St. / pcs.
60	48	M5	Stahl / Steel	7879	100	1,64
60	130	M5	Stahl / Steel	7879.1	50	5,12

Hutschienen nach EN60715 / Top-Hat Rails acc. EN60715

35 x 7,5 x 2000	Mat.-Dicke / Mat.-Thickn.	Artikel-Nr. / Art.-No.	VE/m PU/m	€ / m
galvanisch verzinkt, passiviert, gelocht elec.zinc-plated, passivated, with bores	 1,0 mm	7875	40	4,75
sendzimirverzinkt, gelocht zinc-plated, with bores	 1,0 mm	7895	40	3,43
galvanisch verzinkt, passiviert, ungelocht elec.zinc-plated, passivated, without bores	 1,0 mm	7872	40	4,46
sendzimirverzinkt, ungelocht zinc-plated, without bores	 1,0 mm	7892	40	3,29

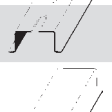
Hutschienen nach EN60715 / Top-Hat Rails acc. EN60715

35 x 15 x 2000	Mat.-Dicke / Mat.-Thickn.	Artikel-Nr. / Art.-No.	VE/m PU/m	€ / m
galvanisch verzinkt, passiviert, gelocht elec.zinc-plated, passivated, with bores	 1,5 mm	7876	20	7,96
sendzimirverzinkt, gelocht zinc-plated, with bores	 1,5 mm	7896	20	6,49
galvanisch verzinkt, passiviert, ungelocht elec.zinc-plated, passivated, without bores	 1,5 mm	7873	20	7,31
sendzimirverzinkt, ungelocht zinc-plated, without bores	 1,5 mm	7893	20	6,37

Weitere Hut- und C-Schienen auf Anfrage / Other dimensions on request
Fixlängen auf Anfrage / Fixed lengths on request

„Lehnen Sie sich zurück!“



Fotografie, Grafik, Text, all rights reserved by MoS Media Group 03/2013, LICATEC®

**„Sie haben den direkten
Kontakt zu Licattec gefunden!“**



Licattec GmbH
Licht und Kabelführungssysteme

Alfred-Nobel-Straße 2-14
50226 Frechen
Germany
Tel.: +49 (0) 22 34 / 9 55 66 - 0
Fax: +49 (0) 22 34 / 9 55 66 - 955

Licattec GmbH
Leuchtenbau und Kabelführungssysteme

Erzstraße 7
09618 Brand-Erbisdorf
Germany
Tel.: +49 (0) 3 73 22 / 33 5 - 0
Fax: +49 (0) 3 73 22 / 25 13