

PRKT

Aktor-/Sensor-Anschlussleitung, M12-Kupplung mit selbstsicherndem Schraubverschluss und angespritztem Kabel, Sechskantmutter aus Edelstahl – besonders für den Einsatz in Nahrungsmittelmaschinen geeignet –

Actuator/sensor cordset, single-ended, M12 female connector with self-locking threaded joint and molded cable, hexagon screw in stainless steel – especially designed for use in food processing equipment –

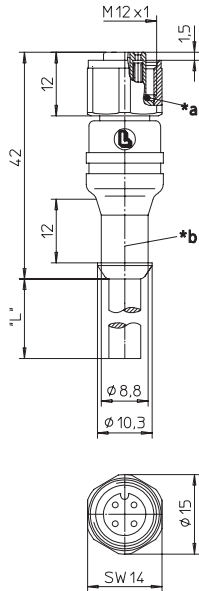

- *a O-Ring
O-ring
- *b Schutzschlauchmontage
hose mounting

PRKWT

Aktor-/Sensor-Anschlussleitung, M12-Winkelkupplung mit selbstsicherndem Schraubverschluss und angespritztem Kabel, Sechskantmutter aus Edelstahl – besonders für den Einsatz in Nahrungsmittelmaschinen geeignet –

Actuator/sensor cordset, single-ended, M12 female right angle connector with self-locking threaded joint and molded cable, hexagon screw in stainless steel – especially designed for use in food processing equipment –

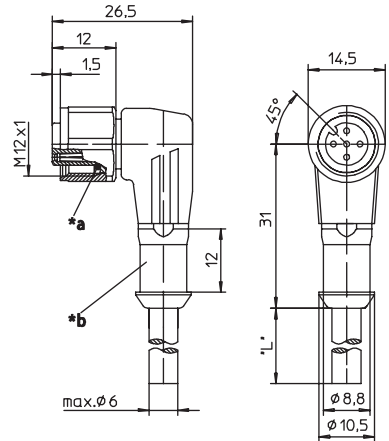

- *a O-Ring
O-ring
- *b Schutzschlauchmontage
hose mounting

**Pinbelegung
Pin assignment**

**4-polig
4 poles**



- 1 = braun / brown
- 2 = weiß / white
- 3 = blau / blue
- 4 = schwarz / black

**5-polig
5 poles**









- 1 = braun / brown
- 2 = weiß / white
- 3 = blau / blue
- 4 = schwarz / black
- 5 = grau / grey

Anschlussleitungen für Aktoren, Sensoren und Verteiler Cordsets, single-ended, for actuators, sensors and distribution boxes

Technische Daten	
Umgebungstemperatur	-25°C / +70°C
Werkstoffe	
Gehäuse / Griffkörper	PVC
Kontaktträger	PVC
Kontakt	CuSn, unternickelt und 0,3 µm vergoldet
Gewindebuchse / Rändelschraube/-mutter / Sechskantschraube/-mutter / Hülse	Edelstahl
O-Ring	EPDM
Mechanische Daten	
Schutzart	IP 67 / IP 69K Nur im verschraubten Zustand mit den dazugehörigen Gegenstücken.
Elektrische Daten	
Durchgangswiderstand	≤ 5 mΩ
Nennstrom bei 40°C	4 A
Nennspannung	4-polig 240 V 5-polig 60 V
Bemessungsspannung	4-polig 250 V 5-polig 63 V
Prüfspannung	4-polig 2,0 kV eff. / 60 s 5-polig 1,5 kV eff. / 60 s
Isolationswiderstand	> 10 ⁹ Ω
Verschmutzungsgrad	3

Technical data	
Operating temperature range	-25°C / +70°C
Materials	
Housing / Molded body	PVC
Insert	PVC
Contact	CuSn, pre-nickel and 0.3 microns gold-plated
Receptacle shell / knurled screw/nut / hexagon screw/nut / sleeve	stainless steel
O-ring	EPDM
Mechanical data	
Degree of protection	IP 67 / IP 69K Only in locked position with its proper counterparts.
Electrical data	
Contact resistance	≤ 5 mΩ
Nominal current at 40°C	4 A
Nominal voltage	4 poles 240 V 5 poles 60 V
Rated voltage	4 poles 250 V 5 poles 63 V
Test voltage	4 poles 2.0 kV eff. / 60 s 5 poles 1.5 kV eff. / 60 s
Insulation resistance	> 10 ⁹ Ω
Pollution degree	3

Bestellbezeichnung Designation		Polzahl Poles	Mantel Outer jacket	
PRKT 4-07/... M	PRKWT 4-07/... M	4	PVC	  
PRKT 5-56/... M	PRKWT 5-56/... M	5	PVC	  
Standardlängen: 5 M / 10 M / 25 M Andere Kabellängen oder Leitungsaufbauten auf Anfrage.		Standard lengths: 5 M / 10 M / 25 M Other cable lengths or cable specifications on request.		