

RKT

Aktor-/Sensor-Anschlussleitung, M12-Kupplung mit selbstsicherndem Schraubverschluss und angespritztem Kabel
 8-6-polig: zum Anschluss an steckbaren Miniatur-Sensor-Verteiler Typ SBS
 12-polig: zum Anschluss an steckbaren Aktor-Sensor-Verteiler Typ ASBSM

Actuator/sensor cordset, single-ended, M12 female connector with self-locking threaded joint and molded cable
 8-6-poles: to connect at plug-gable miniature sensor distribution box type SBS
 12 poles: to connect at plug-gable miniature actuator/sensor distribution box type ASBSM

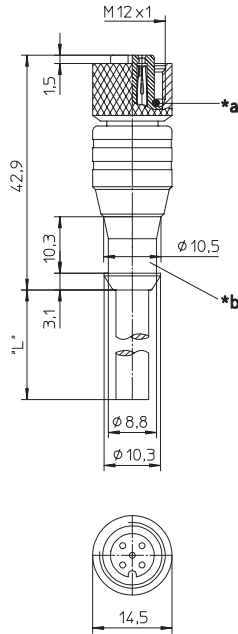

*a O-Ring
 O-ring
 *b Schutzschlauchmontage
 hose mounting

RKWT

Aktor-/Sensor-Anschlussleitung, M12-Winkelkupplung mit selbstsicherndem Schraubverschluss und angespritztem Kabel
 8-6-polig: zum Anschluss an steckbaren Miniatur-Sensor-Verteiler Typ SBS

Actuator/sensor cordset, single-ended, M12 female right angle connector with self-locking threaded joint and molded cable
 8-6-poles: to connect at plug-gable miniature sensor distribution box type SBS

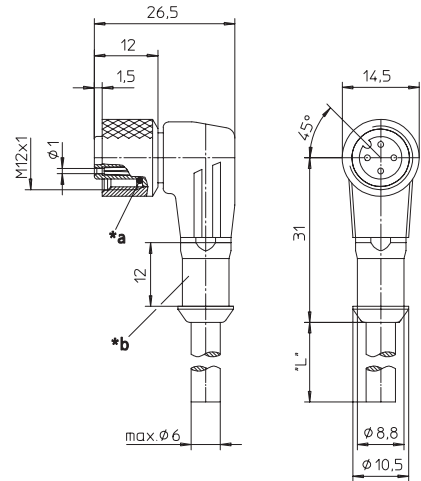

*a O-Ring
 O-ring
 *b Schutzschlauchmontage
 hose mounting

Pinbelegung Pin assignment

3-polig 3 poles

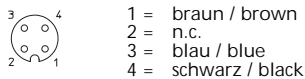

4-polig 4 poles

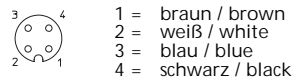

5-polig 5 poles

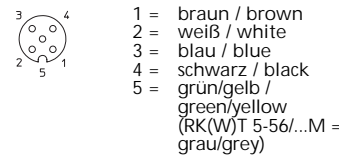

6-polig 6 poles

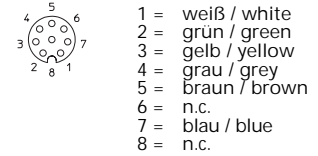

8-polig 8 poles

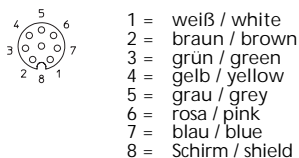



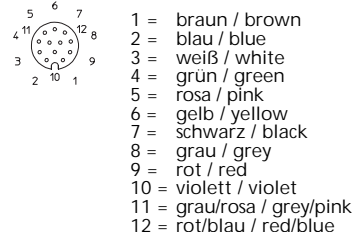























































12-polig 12 poles



Anschlussleitungen für Aktoren, Sensoren und Verteiler Cordsets, single-ended, for actuators, sensors and distribution boxes

Technische Daten		Technical data	
Umgebungstemperatur	-25°C / +80°C	Operating temperature range	-25°C / +80°C
Werkstoffe		Materials	
Gehäuse / Griffkörper	TPU	Housing / Molded body	TPU
Kontaktträger	TPU	Insert	TPU
Kontakt	CuSn (12-polig: CuZn), unternickelt und 0,3 µm vergoldet	Contact	CuSn (12 poles: CuZn), pre-nickelated and 0.3 microns gold-plated
Gewindebuchse / Rändelschraube/-mutter / Sechskantschraube/-mutter / Hülse O-Ring	CuZn, vernickelt FKM	Receptacle shell / knurled screw/nut / hexagon screw/nut / sleeve O-ring	CuZn, nickel-plated FKM
Mechanische Daten		Mechanical data	
Schutzart	IP 67 Nur im verschraubten Zustand mit den dazugehörigen Gegenstücken.	Degree of protection	IP 67 Only in locked position with its proper counterparts.
Elektrische Daten		Electrical data	
Durchgangswiderstand	≤ 5 mΩ	Contact resistance	≤ 5 mΩ
Nennstrom bei 40°C	3- bis 5-polig 4 A, 6- bis 12-polig 2 A	Nominal current at 40°C	3-5 poles 4 A, 6-12 poles 2 A
Nennspannung	3- bis 4-polig 240 V, 5-polig 60 V, 6- bis 12-polig 30 V	Nominal voltage	3-4 poles 240 V, 5 poles 60 V, 6-12 poles 30 V
Bemessungsspannung	3- bis 4-polig 250 V, 5-polig 63 V, 6- bis 12-polig 36 V	Rated voltage	3-4 poles 250 V, 5 poles 63 V, 6-12 poles 36 V
Prüfspannung	3- bis 4-polig 2,0 kV eff. / 60 s 5- bis 8-polig 1,5 kV eff. / 60 s 12-polig 0,5 kV eff. / 60 s	Test voltage	3-4 poles 2.0 kV eff. / 60 s 5-8 poles 1.5 kV eff. / 60 s 12 poles 0.5 kV eff. / 60 s
Isolationswiderstand	> 10 ⁹ Ω	Insulation resistance	> 10 ⁹ Ω
Verschmutzungsgrad	3	Pollution degree	3

Bestellbezeichnung Designation		Polzahl Poles	Mantel Outer jacket	
RKT 4-3-06/... M	RKWT 4-3-06/... M		PVC	 
RKT 4-3-224/... M	RKWT 4-3-224/... M	3	PUR halogenfrei / halogen free	   
RKT 4-3-260/... M	RKWT 4-3-260/... M		PUR halogenfrei / halogen free schweißfunkenfest / welding spark proof	    
RKT 4-07/... M	RKWT 4-07/... M		PVC	 
RKT 4-225/... M	RKWT 4-225/... M	4	PUR halogenfrei / halogen free	   
RKT 4-251/... M	RKWT 4-251/... M		PUR halogenfrei / halogen free schweißfunkenfest / welding spark proof	    
			PUR halogenfrei / halogen free schweißfunkenfest / welding spark proof	    
RKT 5-56/... M	RKWT 5-56/... M		PVC	 
RKT 5-226/... P89 <small>(Pin 2 und 4 nicht belegt / Pin 2 and 4 not connected)</small>		5	PUR halogenfrei / halogen free	   
RKT 5-228/... M	RKWT 5-228/... M		PUR halogenfrei / halogen free	   
RKT 5-259/... M			PUR halogenfrei / halogen free schweißfunkenfest / welding spark proof	    
RKT 8-6-268/... M	RKWT 8-6-268/... M	6	PUR halogenfrei / halogen free schweißfunkenfest / welding spark proof	     
RKT 8-6-337/... M	RKWT 8-6-337/... M		PUR halogenfrei / halogen free	   
RKT 8-282/... M	RKWT 8-282/... M	8	PUR	   
RKT 12-348/... M	RKWT 12-348/... M	12	PUR halogenfrei / halogen free	  

Standardlängen: 2 M / 5 M / 10 M
Andere Kabellängen oder Leitungsaufbauten auf Anfrage.

Standard lengths: 2 M / 5 M / 10 M
Other cable lengths or cable specifications on request.