

RSMV

Aktor-/Sensor-Anschlussleitung, M8-Stecker mit selbstsicherndem Schraubverschluss und angespritztem Kabel

Actuator/sensor cordset, single-ended, M8 male connector with self-locking threaded joint and molded cable

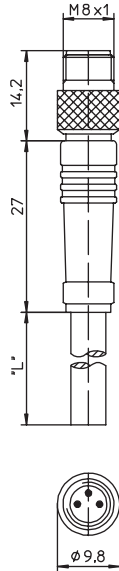

RSMWV

Aktor-/Sensor-Anschlussleitung, M8-Winkelstecker mit selbstsicherndem Schraubverschluss und angespritztem Kabel

Actuator/sensor cordset, single-ended, M8 male right angle connector with self-locking threaded joint and molded cable

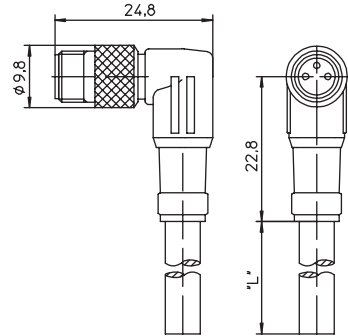

Pinbelegung
Pin assignment

3-polig
3 poles



- 1 = braun / brown
- 3 = blau / blue
- 4 = schwarz / black













4-polig
4 poles



- 1 = braun / brown
- 2 = weiß / white
- 3 = blau / blue
- 4 = schwarz / black

Anschlussleitungen für Aktoren, Sensoren und Verteiler Cordsets, single-ended, for actuators, sensors and distribution boxes

Technische Daten		Technical data	
Umgebungstemperatur	-40°C / +90°C	Operating temperature range	-40°C / +90°C
Werkstoffe		Materials	
Gehäuse / Griffkörper	TPU	Housing / Molded body	TPU
Kontaktträger	PA / TPU	Insert	PA / TPU
Kontakt	CuZn, unternickelt und 0,8 µm vergoldet	Contact	CuZn, pre-nickeled and 0.8 microns gold-plated
Gewindebuchse / Rändelschraube/-mutter / Sechskantschraube/-mutter / Hülse	CuZn, vernickelt	Receptacle shell / knurled screw/nut / hexagon screw/nut / sleeve	CuZn, nickel-plated
Mechanische Daten		Mechanical data	
Schutzart	IP 67 Nur im verschraubten Zustand mit den dazugehörigen Gegenstücken.	Degree of protection	IP 67 Only in locked position with its proper counterparts.
Elektrische Daten		Electrical data	
Durchgangswiderstand	≤ 5 mΩ	Contact resistance	≤ 5 mΩ
Nennstrom bei 40°C	4 A	Nominal current at 40°C	4 A
Nennspannung	3-polig 60 V 4-polig 30 V	Nominal voltage	3 poles 60 V 4 poles 30 V
Bemessungsspannung	3-polig 63 V 4-polig 36 V	Rated voltage	3 poles 63 V 4 poles 36 V
Prüfspannung	3-polig 1,5 kV eff. / 60 s 4-polig 0,8 kV eff. / 60 s	Test voltage	3 poles 1.5 kV eff. / 60 s 4 poles 0.8 kV eff. / 60 s
Isolationswiderstand	> 10 ⁹ Ω	Insulation resistance	> 10 ⁹ Ω
Verschmutzungsgrad	3	Pollution degree	3

Bestellbezeichnung Designation	Polzahl Poles	Mantel Outer jacket	
RSMV 3-06/... M	RSMWV 3-06/... M	PVC	 
RSMV 3-224/... M	RSMWV 3-224/... M	PUR halogenfrei / halogen free	   
RSMV 4-07/... M	RSMWV 4-07/... M	PVC	 
RSMV 4-225/... M	RSMWV 4-225/... M	PUR halogenfrei / halogen free	   
Standardlängen: 2 M / 5 M / 10 M Andere Kabellängen oder Leitungsaufbauten auf Anfrage.		Standard lengths: 2 M / 5 M / 10 M Other cable lengths or cable specifications on request.	