



Product range >> Measuring transducers

**art. nr.: 62011**

**SWMU 41.51 25A/4...20mA 0...10V 230V AC  
Cl.0.5**



---

### Electrical Attributes:

Primary current:	25 A
Measuring output 1:	4...20 {mA}
Measuring output 2:	0...10 {V}
Auxiliary voltage AC:	230 V AC
Class:	0,5

---

### Dimensions:

{Schiene}:	40 x 12 mm
Round conductor:	27 mm
Width:	80 mm
Height:	135 mm
Depth:	71 mm
Weight:	350 {g}



**Technical Drawing:**

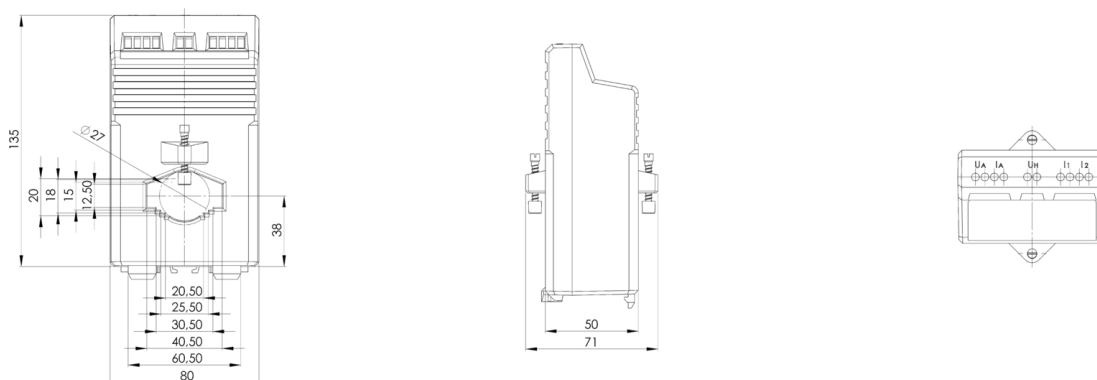

**Contact:**

MBS AG  
Sulzbach Messwandler  
Eisbachstraße 51  
D-74429 Sulzbach-Laufen

Tel.: +49 7976 9851-0  
Fax: +49 7976 9851-90  
orders@mbs-ag.com

