



Product range >> Measuring transducers

art. nr.: 66026

**SWMU 41.51 800A/4...20mA 0...10V 24V DC
Cl.0.5**



Electrical Attributes:

Primary current:	800 A
Measuring output 1:	4...20 {mA}
Measuring output 2:	0...10 {V}
Auxiliary voltage DC:	24 V DC
Class:	0,5

Dimensions:

{Schiene}:	40 x 12 mm
Round conductor:	27 mm
Width:	80 mm
Height:	135 mm
Depth:	71 mm
Weight:	250 {g}



Technical Drawing:

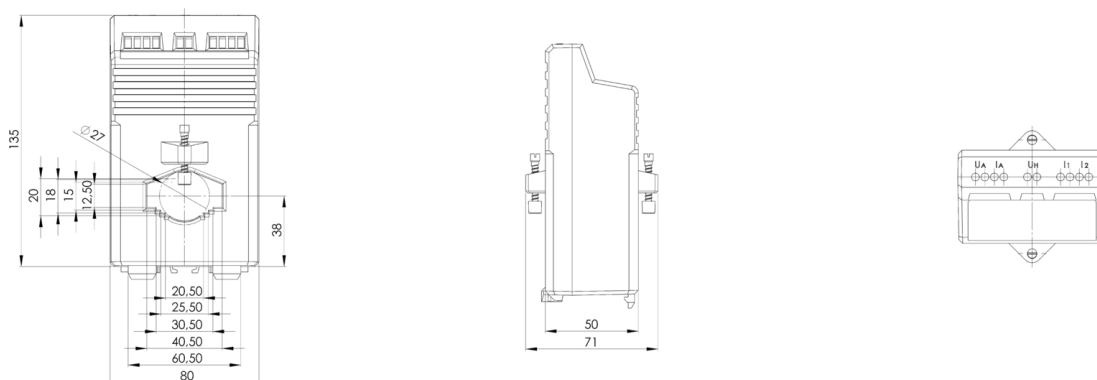

Contact:

MBS AG
Sulzbach Messwandler
Eisbachstraße 51
D-74429 Sulzbach-Laufen

Tel.: +49 7976 9851-0
Fax: +49 7976 9851-90
orders@mbs-ag.com

