

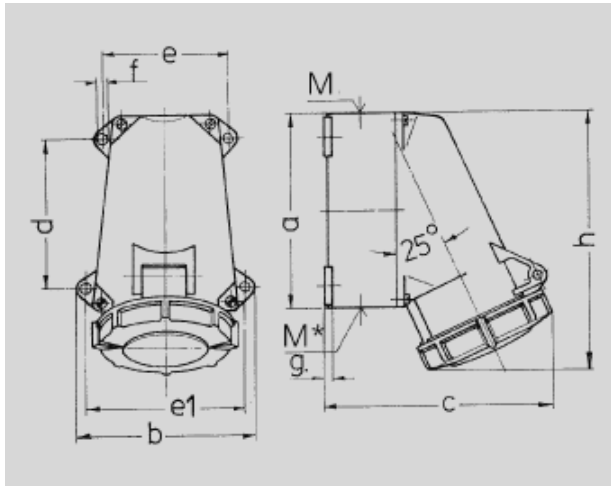

 Part no. : 1196  
**Receptacle**

with 4 external fixing holes, with one cable entry at top and one blind cable entry (can be cut out) at bottom



| Drawing<br>1 MB 219   | Amp.<br>Poles | 16                    |      |      | 32            |      |      |
|---|---------------|-----------------------|------|------|---------------|------|------|
|   |               | 3                     | 4    | 5    | 3             | 4    | 5    |
| Dim. in mm  | a             | 95                    | 95   | 95   | 120           | 120  | 120  |
|   | b             | 102                   | 102  | 102  | 112           | 112  | 112  |
|   | c             | 115                   | 124  | 129  | 143           | 143  | 150  |
|   | d             | 64,2                  | 64,2 | 64,2 | 90,2          | 90,2 | 90,2 |
|   | e             | 77,5                  | 77,5 | 77,5 | 79            | 79   | 79   |
|   | e1            | 88                    | 88   | 88   | 98,5          | 98,5 | 98,5 |
|   | f             | 5,5                   | 5,5  | 5,5  | 5,5           | 5,5  | 5,5  |
|   | g             | 5                     | 5    | 5    | 5             | 5    | 5    |
|   | h             | 128                   | 128  | 132  | 160           | 160  | 160  |
|   | M             | 20                    | 25   | 25   | 32            | 32   | 32   |
|   | M*            | 20                    | 25   | 25   | M32 (blind)   |      |      |
|   |               | (blind) to be cut out |      |      | to be cut out |      |      |
| Max. cable diam. (mm)   |               | 15                    | 18   | 18   | 25            | 25   | 25   |
| Terminal for cond. cross section (mm <sup>2</sup> ) min.-max. |               | 1,5                   | 1,5  | 1,5  | 2,5           | 2,5  | 2,5  |
|   |               | -4                    | -4   | -4   | -10           | -10  | -10  |

 Article-group : **1049**

voltages : 400V

rated current : 16A

pole : 4 pole







IP protection types : IP67

position of ground contact : 6h

packing unit : 0010

weight : 270 g

**PART NUMBERS**

|             | V      | <b>110V</b>   | <b>230V</b>   | <b>400V</b>   | <b>500V</b>   | <b>&gt;50-500V</b>  |   |
|-------------|--------|---|---|---|---|---|---|
|             | Hz     | 50,60   | 50,60   | 50,60   | 50,60   | 100-300   | 300-500   |
|             | colour |  |  |  |  |  |  |
|             | amp.   |   |   |   |   |   |   |
| <b>16 A</b> | 3      | 1193  | 1192  | 1211  |   |   |   |
|             | 4      | 1194  | 1195  | <b>1196</b>   | 1197  | 1212  | 1213  |
|             | 5      | 1198  | 1199  | 1200  |   |   |   |
| <b>32 A</b> | 3      | 1201  | 1202  | 1203  |   |   |   |
|             | 4      | 1204  | 1205  | 1206  | 1207  | 1214  | 1215  |
|             | 5      | 1208  | 1209  | 1210  |   |   |   |