

Panel mounted receptacle with TwinCONTACT - Part no. 1746



- screwless spring terminals
- suitable for through wiring
- 20° inclination

Protection type	IP 44
Ampere	32A
Poles	5p
Voltage	400V
Hertz	50-60 Hz
Earth position	6h
Contact	standard
Connection technology	Screwless - TwinCONTACT

Std. Pack. 10 Qty.

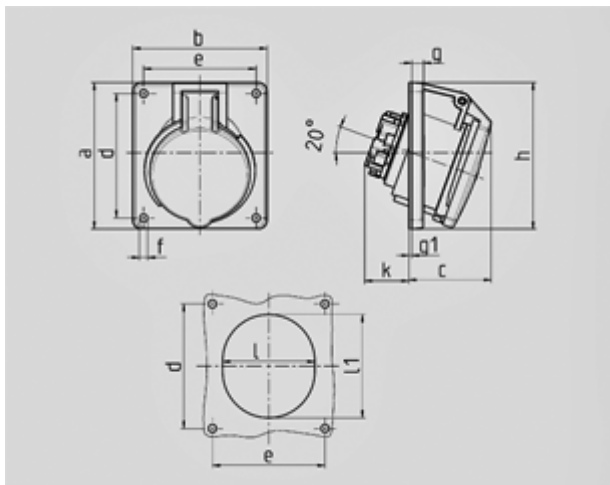

Drawing	Amp.	16			32		
		3	4	5	3	4	5
1 MB 465	Poles						
Dim. in mm	a	73,5	100	100	100	100	100
	b	64	92	92	92	92	92
	c	52	58	58	61	61	60
	d	60	85	85	85	85	85
	e	52	77	77	77	77	77
	f	5,5	5,5	5,5	5,5	5,5	5,5
	g	7	8	8	8	8	8
	g.1	2	2	2	2	2	2
	h	79	100	100	103	103	105
	k	31	31	31	44	44	54
	l	52	55	65	70	70	73
	l1	60	63	72	82	82	85
	Terminal for cond. cross section (mm²) min.-max.	1,5	1,5	1,5	2,5	2,5	2,5
		-4	-4	-4	-6	-6	-6