

Plug StarTOP® with SafeCONTACT - Part no. 948

- screwless, with insulating displacing technique
- SafeCONTACT
- cable gland and sealing
- strain relief and protection against kinking
- enclosure with thread lock and safety slide

Protection type	IP 44
Ampere	16A
Poles	3p
Voltage	230V
Hertz	50-60 Hz
Earth position	6h
Contact	standard
Connection technology	Screwless - SafeCONTACT

Std. Pack. 10 Qty.

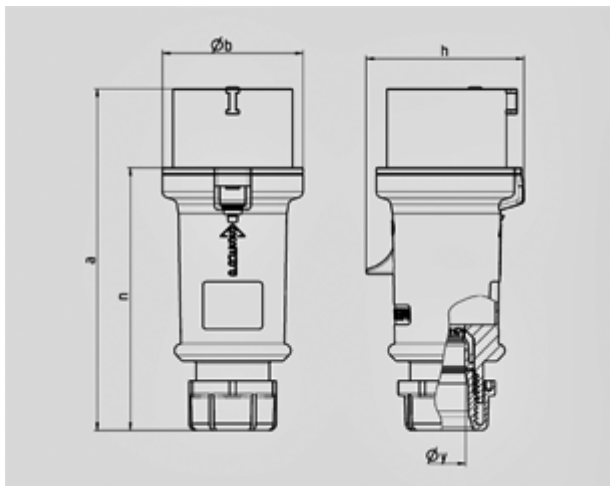

Drawing	Amp.	16			32		
		Poles			3	4	5
2 MB 214							
Dim. in mm	a	148	160	160	197	197	197
	b	55	65,6	65,6	75	75	75
	h	61	72,5	72,5	80,5	80,5	85
	n	112	123,5	123,5	152	152	152
	y	14,5	16	16	22	22	22
Terminal for cond. cross		1	1	1	2,5	2,5	2,5
section (mm ²) min.-max.		-2,5	-2,5	-2,5	-6	-6	-6