





Main switch, 3 pole + 1 N/O, 20 A, STOP function, 90 °, Lockable in the 0 (Off) position, surface mounting

Part no. T0-2-15679/11/SVB-SW
Article no. 207150

Delivery program

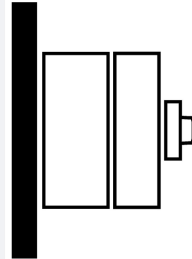
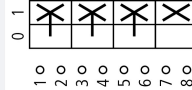
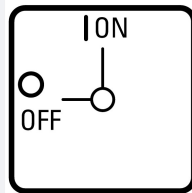
| | | | |
|---|----------------|-----------------|--|
| Product range | | | Main switch maintenance switch Repair switch |
| Part group reference | | | T0 |
| Stop Function | | | STOP function With black rotary handle and locking ring |
| Number of poles | | | 3 pole |
| Auxiliary contacts | | | |
|  | | N/O | 1 |
|  | | N/C | 0 |
| Locking facility | | | Lockable in the 0 (Off) position |
| Degree of Protection | | | IP65 |
| Design | | | totally insulated surface mounting  |
| Contact sequence | | |  |
| Switching angle | | ° | 90 |
| Function | | |  |
| Motor rating AC-23A, 50 - 60 Hz | | | |
| 400 V | P | kW | 5.5 |
| Rated uninterrupted current | I _u | A | 20 |
| Number of contact units | | contact unit(s) | 2 |

Technical data

| | | | |
|---------------------|--|--|---|
| General | | | |
| Standards | | | IEC/EN 60947, VDE 0660, IEC/EN 60204 Switch-disconnector according to IEC/EN 60947-3 |
| Climatic proofing | | | Damp heat, constant, to IEC 60068-2-78 Damp heat, cyclic, to IEC 60068-2-30 |
| Ambient temperature | | | |

| | | | |
|---|-----------|------|-------------------------------|
| Enclosed | | °C | -25 - +40 |
| Overtoltage category/pollution degree | | | III/3 |
| Rated impulse withstand voltage | U_{imp} | V AC | 6000 |
| Mechanical shock resistance | | g | 15 |
| Mounting position | | | As required |
| Protection against direct contact when actuated from front (EN 50274) | | | Finger and back-of-hand proof |

Contacts

| | | | |
|---|----------|-----------|--|
| Mechanical variables | | | |
| Number of poles | | | 3 pole |
| Auxiliary contacts | | | |
| | | N/O | 1 |
| | | N/C | 0 |
| Electrical characteristics | | | |
| Rated operational voltage | U_e | V AC | 690 |
| Rated uninterrupted current | I_u | A | 20 |
| Note on rated uninterrupted current I_u | | | Rated uninterrupted current I_u is specified for max. cross-section. |
| Load rating with intermittent operation, class 12 | | | |
| AB 25 % DF | | $x I_e$ | 2 |
| AB 40 % DF | | $x I_e$ | 1.6 |
| AB 60 % DF | | $x I_e$ | 1.3 |
| Short-circuit rating | | | |
| Fuse | | A gG/gL | 20 |
| Rated short-time withstand current (1 s current) | I_{cw} | A_{rms} | 320 |
| Note on rated short-time withstand current I_{cw} | | | Current for a time of 1 second |
| Rated conditional short-circuit current | I_q | kA | 6 |

Switching capacity

| | | | |
|--|--------------|----------|-------|
| $\cos \varphi$ rated making capacity as per IEC 60947-3 | | A | 130 |
| Rated breaking capacity $\cos \varphi$ to IEC 60947-3 | | A | |
| 230 V | | A | 100 |
| 400/415 V | | A | 110 |
| 500 V | | A | 80 |
| 690 V | | A | 60 |
| Safe isolation to EN 61140 | | | |
| between the contacts | | V AC | 440 |
| Current heat loss per contact at I_e | | W | 0.6 |
| Current heat loss per auxiliary circuit at I_e (AC-15/230 V) | | CO | 0.6 |
| Lifespan, mechanical | Operations | $x 10^6$ | > 0.4 |
| Maximum operating frequency | Operations/h | | 1200 |
| AC | | | |
| AC-3 | | | |
| Rating, motor load switch | P | kW | |
| 220 V 230 V | P | kW | 3 |
| 230 V Star-delta | P | kW | 5.5 |
| 400 V 415 V | P | kW | 5.5 |
| 400 V Star-delta | P | kW | 7.5 |
| 500 V | P | kW | 5.5 |
| 500 V Star-delta | P | kW | 7.5 |
| 690 V | P | kW | 4 |
| 690 V Star-delta | P | kW | 5.5 |
| Rated operational current motor load switch | | | |
| 230 V | I_e | A | 11.5 |
| 230 V star-delta | I_e | A | 20 |
| 400V 415 V | I_e | A | 11.5 |
| 400 V star-delta | I_e | A | 20 |

| | | | |
|---|-------------------|----------------|---|
| 500 V | I _e | A | 9 |
| 500 V star-delta | I _e | A | 15.6 |
| 690 V | I _e | A | 4.9 |
| 690 V star-delta | I _e | A | 8.5 |
| AC-21A | | | |
| Rated operational current switch | | | |
| 440 V | I _e | A | 20 |
| AC-23A | | | |
| Motor rating AC-23A, 50 - 60 Hz | | | |
| 230 V | P | kW | 3 |
| 400 V 415 V | P | kW | 5.5 |
| 500 V | P | kW | 7.5 |
| 690 V | P | kW | 5.5 |
| Rated operational current motor load switch | | | |
| 230 V | I _e | A | 13.3 |
| 400 V 415 V | I _e | A | 13.3 |
| 500 V | I _e | A | 13.3 |
| 690 V | I _e | A | 7.6 |
| DC | | | |
| DC-1, Load-break switches L/R = 1 ms | | | |
| Rated operational current | I _e | A | 10 |
| Voltage per contact pair in series | | V | 60 |
| DC-21A | | | |
| Rated operational current | I _e | A | 1 |
| Contacts | | Quantity | 1 |
| DC-23A, motor load switch L/R = 15 ms | | | |
| 24 V | | | |
| Rated operational current | I _e | A | 10 |
| Contacts | | Quantity | 1 |
| 48 V | | | |
| Rated operational current | I _e | A | 10 |
| Contacts | | Quantity | 2 |
| 60 V | | | |
| Rated operational current | I _e | A | 10 |
| Contacts | | Quantity | 3 |
| 120 V | | | |
| Rated operational current | I _e | A | 5 |
| Contacts | | Quantity | 3 |
| 240 V | | | |
| Rated operational current | I _e | A | 5 |
| Contacts | | Quantity | 5 |
| DC-13, Control switches L/R = 50 ms | | | |
| Rated operational current | I _e | A | 10 |
| Voltage per contact pair in series | | V | 32 |
| Control circuit reliability at 24 V DC, 10 mA | Fault probability | H _F | < 10 ⁻⁵ , < 1 fault in 100000 operations |

Terminal capacities

| | | | |
|-------------------------------------|--|-----------------|--------------------------------------|
| Solid or stranded | | mm ² | 1 x (1 - 2,5) 2 x (1 - 2,5) |
| Flexible with ferrules to DIN 46228 | | mm ² | 1 x (0.75 - 2.5) 2 x (0.75 - 2.5) |
| Terminal screw | | | M3.5 |
| Max. tightening torque | | Nm | 1 |

Technical safety parameters:

| | | | |
|-------|--|--|---|
| Notes | | | B10 _d values as per EN ISO 13849-1, table C1 |
|-------|--|--|---|

Rating data for approved types

| | | | |
|-------------------|--|-------|------|
| Terminal capacity | | | |
| Terminal screw | | | M3.5 |
| Tightening torque | | lb-in | 8.83 |

Design verification as per IEC/EN 61439

| | | | |
|--|------------|----|--|
| Technical data for design verification | | | |
| Rated operational current for specified heat dissipation | I_n | A | 20 |
| Heat dissipation per pole, current-dependent | P_{vid} | W | 0.6 |
| Equipment heat dissipation, current-dependent | P_{vid} | W | 0 |
| Static heat dissipation, non-current-dependent | P_{vs} | W | 0 |
| Heat dissipation capacity | P_{diss} | W | 0 |
| Operating ambient temperature min. | | °C | -25 |
| Operating ambient temperature max. | | °C | 40 |
| IEC/EN 61439 design verification | | | |
| 10.2 Strength of materials and parts | | | |
| 10.2.2 Corrosion resistance | | | Meets the product standard's requirements. |
| 10.2.3.1 Verification of thermal stability of enclosures | | | Meets the product standard's requirements. |
| 10.2.3.2 Verification of resistance of insulating materials to normal heat | | | Meets the product standard's requirements. |
| 10.2.3.3 Verification of resistance of insulating materials to abnormal heat and fire due to internal electric effects | | | Meets the product standard's requirements. |
| 10.2.4 Resistance to ultra-violet (UV) radiation | | | Please enquire |
| 10.2.5 Lifting | | | Does not apply, since the entire switchgear needs to be evaluated. |
| 10.2.6 Mechanical impact | | | Does not apply, since the entire switchgear needs to be evaluated. |
| 10.2.7 Inscriptions | | | Meets the product standard's requirements. |
| 10.3 Degree of protection of ASSEMBLIES | | | Does not apply, since the entire switchgear needs to be evaluated. |
| 10.4 Clearances and creepage distances | | | Meets the product standard's requirements. |
| 10.5 Protection against electric shock | | | Does not apply, since the entire switchgear needs to be evaluated. |
| 10.6 Incorporation of switching devices and components | | | Does not apply, since the entire switchgear needs to be evaluated. |
| 10.7 Internal electrical circuits and connections | | | Is the panel builder's responsibility. |
| 10.8 Connections for external conductors | | | Is the panel builder's responsibility. |
| 10.9 Insulation properties | | | |
| 10.9.2 Power-frequency electric strength | | | Is the panel builder's responsibility. |
| 10.9.3 Impulse withstand voltage | | | Is the panel builder's responsibility. |
| 10.9.4 Testing of enclosures made of insulating material | | | Is the panel builder's responsibility. |
| 10.10 Temperature rise | | | The panel builder is responsible for the temperature rise calculation. Eaton will provide heat dissipation data for the devices. |
| 10.11 Short-circuit rating | | | Is the panel builder's responsibility. The specifications for the switchgear must be observed. |
| 10.12 Electromagnetic compatibility | | | Is the panel builder's responsibility. The specifications for the switchgear must be observed. |
| 10.13 Mechanical function | | | The device meets the requirements, provided the information in the instruction leaflet (IL) is observed. |

Technical data ETIM 6.0

| | | | |
|--|--|---|-----------|
| Low-voltage industrial components (EG000017) / Switch disconnector (EC000216) | | | |
| Electric engineering, automation, process control engineering / Low-voltage switch technology / Off-load switch, circuit breaker, control switch / Switch disconnector (ecl@ss8.1-27-37-14-03 [AKF060010]) | | | |
| Version as main switch | | | Yes |
| Version as maintenance-/service switch | | | Yes |
| Version as safety switch | | | No |
| Version as emergency stop installation | | | No |
| Version as reversing switch | | | No |
| Max. rated operation voltage U_e AC | | V | 690 |
| Rated operating voltage | | V | 690 - 690 |
| Rated permanent current I_u | | A | 20 |
| Rated permanent current at AC-21, 400 V | | A | 20 |

| | | |
|---|----|----------------------------|
| Rated operation power at AC-3, 400 V | kW | 5.5 |
| Rated short-time withstand current I _{cw} | kA | 0.32 |
| Rated operation power at AC-23, 400 V | kW | 5.5 |
| Switching power at 400 V | kW | 5.5 |
| Conditioned rated short-circuit current I _q | kA | 6 |
| Number of poles | | 3 |
| Number of auxiliary contacts as normally closed contact | | 0 |
| Number of auxiliary contacts as normally open contact | | 1 |
| Number of auxiliary contacts as change-over contact | | 0 |
| Motor drive optional | | No |
| Motor drive integrated | | No |
| Voltage release optional | | No |
| Device construction | | Complete device in housing |
| Suitable for ground mounting | | Yes |
| Suitable for front mounting 4-hole | | No |
| Suitable for front mounting center | | No |
| Suitable for distribution board installation | | No |
| Suitable for intermediate mounting | | No |
| Colour control element | | Black |
| Type of control element | | Door coupling rotary drive |
| Interlockable | | Yes |
| Type of electrical connection of main circuit | | Screw connection |
| Degree of protection (IP), front side | | IP65 |

Dimensions

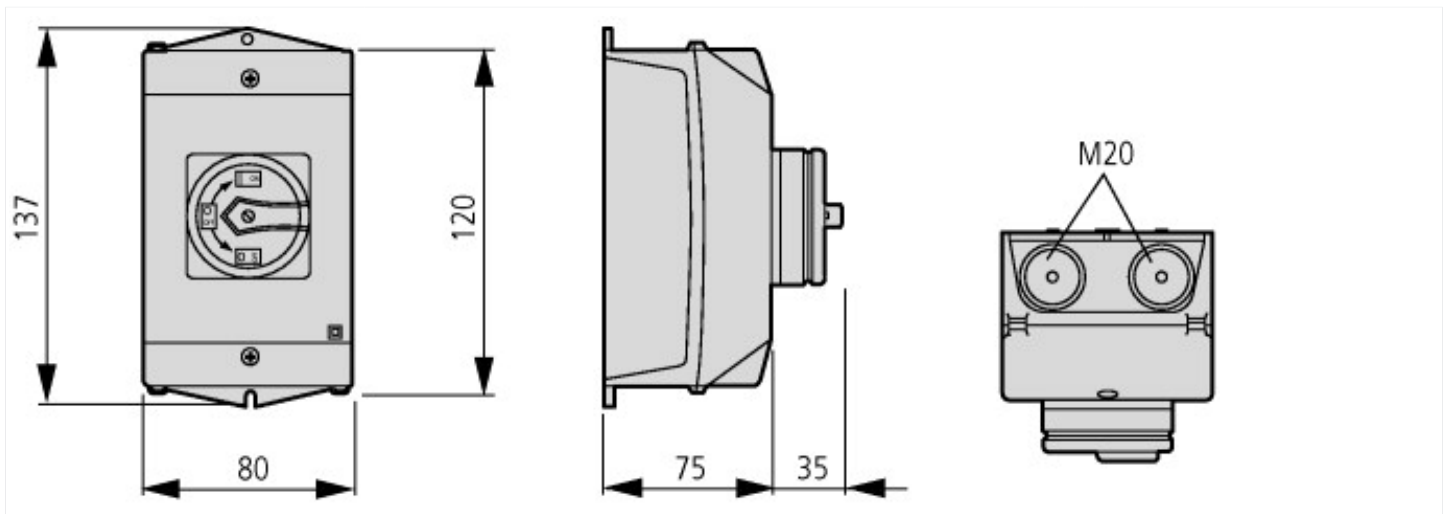

M4

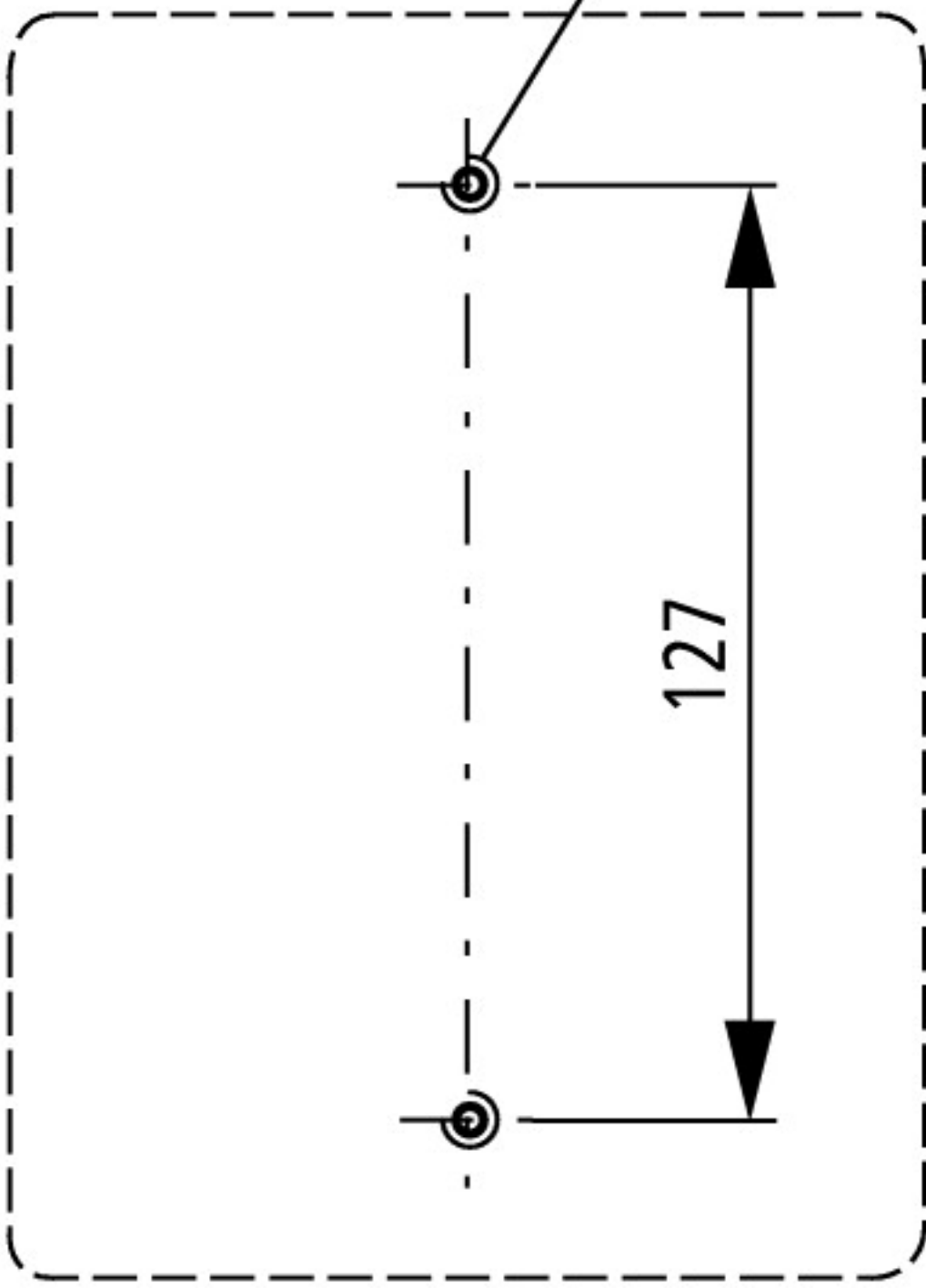

Drilling dimensions base



$d = 4 - 8 \text{ mm}$

$b + d \leq 47 \text{ mm}$

$d = 0.16 - 0.31''$

$b + d \leq 1.85''$

 3 padlocks

Additional product information (links)

IL03801007Z (AWA1150-1687) Cam switch: Surface mounting enclosure

| | |
|---|---|
| IL03801007Z (AWA1150-1687) Cam switch: Surface mounting enclosure | ftp://ftp.moeller.net/DOCUMENTATION/AWA_INSTRUCTIONS/IL03801007Z2016_07.pdf |
| Form for ordering non-standard front plates | http://ecat.moeller.net/flip-cat/?edition=HPLEN&startpage=4.87 |
| Display flip catalog page. | http://ecat.moeller.net/flip-cat/?edition=K115A&startpage=40 |
| Technical overview cam switch, switch-disconnector | http://de.ecat.moeller.net/flip-cat/?edition=HPLTEv1&startpage=4.2 |
| System overview cam switch T | http://de.ecat.moeller.net/flip-cat/?edition=HPLTEv1&startpage=4.4 |
| System overview switch-disconnector P | http://de.ecat.moeller.net/flip-cat/?edition=HPLTEv1&startpage=4.6 |
| Key to part numbers Cam switch | http://de.ecat.moeller.net/flip-cat/?edition=HPLTEv1&startpage=4.8 |
| Key to part numbers Switch-disconnector | http://de.ecat.moeller.net/flip-cat/?edition=HPLTEv1&startpage=4.8 |
| Switches for ATEX | http://www.coopercrouse-hinds.eu/en/products/25-ex-safety-and-main-current-switches.html |