

Last Revised: 2014-11-06 07:14:39.0

Low-Cost M Series Multifunction Data Acquisition - 16-Bit, 250 kS/s, up to 80 Analog Inputs

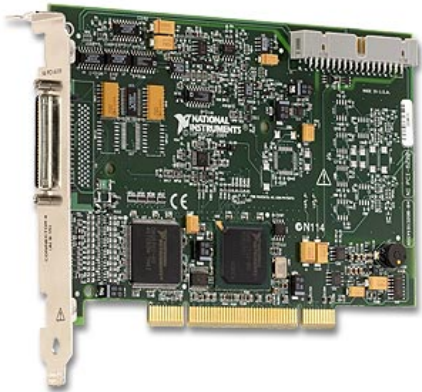

- NI recommends high-speed M Series (NI 625x) for 5X faster sampling rates, high-accuracy M Series (NI 628x) for 4X higher resolution, or industrial M Series (NI 623x) for 60 VDC isolation and superior noise rejection
- 16, 32, or 80 analog inputs at 16 bits, 250 kS/s
- Up to 4 analog outputs at 16 bits, 833 kS/s (6 μ s full-scale settling time)
- Programmable input range (± 10 , ± 5 , ± 1 , ± 0.2 V) per channel
- Up to 48 TTL/CMOS digital I/O lines (up to 32 hardware-timed at 1 MHz)
- Two 32-bit, 80 MHz counter/timers
- Digital triggering
- X1, X2, or X4 quadrature encoder inputs

Overview

NI M Series low-cost multifunction data acquisition (DAQ) devices provide optimized functionality for cost-sensitive applications. They have up to 80 analog inputs, 48 digital I/O lines, four analog outputs, two counter/timers, and digital triggering. Low-cost M Series devices have a one-year calibration interval. For better accuracy, faster speeds, and an extended two-year calibration service, consider high-speed and high-accuracy M Series devices.

[Back to Top](#)

Requirements and Compatibility

OS Information

- Linux®
- Mac OS X
- Windows 2000/XP
- Windows 7
- Windows Vista x64/x86

Driver Information

- NI-DAQmx
- NI-DAQmx Base

Software Compatibility

- ANSI C
- LabVIEW
- LabWindows/CVI
- Measurement Studio
- SignalExpress
- Visual Basic
- Visual Studio .NET

[Back to Top](#)

Comparison Tables

Family	Bus	Analog Inputs	Analog Input Resolution (bits)	Analog Outputs (AO)	AO Resolution (bits)	Max AO Rate (kS/S)	AO Range (V)	Digital I/O	Correlated (clocked) DIO
NI 6220	PCI, PXI	16	16	-	-	-	-	24	8, up to 1 MHz
NI 6221	PCI, PXI, USB	16	16	2	16	833	± 10	24	8, up to 1 MHz
NI 6221 (37-pin)	PCI	16	16	2	16	833	± 10	10	2, up to 1 MHz
NI 6224	PCI, PXI	32	16	-	-	-	-	48	32, up to 1 MHz

Family	Bus	Analog Inputs	Analog Input Resolution (bits)	Analog Outputs (AO)	AO Resolution (bits)	Max AO Rate (kS/S)	AO Range (V)	Digital I/O	Correlated (clocked) DIO
NI 6225	PCI, PXI, USB	80	16	2	16	833	±10	24	8, up to 1 MHz
NI 6229	PCI, PXI, USB	32	16	4	16	833	±10	48	32, up to 1 MHz

[Back to Top](#)

Application and Technology

M Series for Test

For test, you can use 16-bit, 250 kS/s analog inputs and 1 MHz digital lines with NI signal conditioning for applications including data logging and sensor measurements. Low-cost M Series devices are compatible with the NI SCC and SCXI signal conditioning platforms, which provide amplification, filtering, and power for virtually every type of sensor. These platforms also are compliant with IEEE 1451.4 smart transducer electronic data sheet (TEDS) sensors, which provide digital storage for sensor data sheet information.

M Series for Control

Low-cost M Series digital lines can drive 24 mA for relay and actuator control. With up to four analog outputs, two 80 MHz counter/timers, and six DMA channels, M Series devices can execute multiple control loops simultaneously. Low-cost M Series devices also have direct support for encoder measurements, protected digital lines, and digital debounce filters for control applications. With up to 80 analog inputs, 32 clocked digital lines at rates of 1 MHz, and four analog outputs, you can execute multiple control loops with a single device. For higher-count control loops, you can use M Series devices in conjunction and tightly synchronized with National Instruments analog output devices for 64 or more loops.

M Series for Design

You can use the wide range of I/O – from 80 analog inputs to 48 digital lines – to measure and verify prototype designs. M Series devices and NI LabVIEW SignalExpress interactive measurement software deliver benchtop measurements to the PC. With LabVIEW SignalExpress interactive configuration-based steps, you can quickly create design verification tests. The fast acquisition and generation rates of low-cost M Series devices along with LabVIEW SignalExpress provide on-the-fly design analysis. You can convert your tested and verified LabVIEW SignalExpress projects to LabVIEW applications for immediate M Series DAQ use and bridge the gap between test, control, and design applications.

Hybrid-Slot-Compatible PXI Modules

PXI M Series modules are hybrid-slot-compatible so that you can use them in both PXI slots and the hybrid slots found in new PXI Express chassis. The PXI Systems Alliance specifies that hybrid-slot-compatible PXI modules use modified slot connectors to mechanically fit in both PXI slots and hybrid slots. This mechanical change:

- Provides compatibility with past, current, and future PXI chassis
- Maintains existing product specifications
- Requires no software changes (application or driver)
- Maintains speed and capability of all PXI communication (PXI Express signaling is not provided)

However, hybrid-slot-compatible PXI modules do not include the pins used to implement PXI local bus communication, which is used for backplane SCXI control from the right-most PXI slot in PXI/SCXI combination chassis (NI PXI-1010, PXI-1011, PXI-1050, and PXI-1052). For these applications, NI provides unmodified PXI M Series modules that maintain the required local bus capabilities. Refer to the SCXI Control of PXI/SCXI Combination Chassis section in the Ordering Information section for part numbers.

Simultaneous and Intelligent Data Acquisition

When you need to obtain performance from a data acquisition device beyond the capabilities of a multifunction data acquisition device, National Instruments provides simultaneous sampling with NI S Series and intelligent data acquisition with NI R Series. The S Series architecture dedicates an analog-to-digital converter (ADC) per channel to provide higher aggregate sampling rates compared to multiplexed devices. S Series devices are ideal for applications including IF digitization, transient recording, ultrasound and sonar testing, and high-energy physics. R Series multifunction DAQ devices contain a field-programmable gate array (FPGA) that is reconfigurable using the LabVIEW FPGA Module. R Series multifunction devices combine analog input, analog output, and digital I/O on a single device. You can customize these devices to develop capabilities such as complete control over the synchronization and timing of all signals and operations; user-defined onboard decision-making logic; and digital lines individually configurable as input, output, counter/timers, pulse-width modulation (PWM), flexible encoder inputs, or user-defined communication protocols.

Industrial M Series

When you need performance and accuracy from a data acquisition device in an electrically noisy or harsh environment, consider industrial NI M Series devices. They offer a set of high-reliability features, including isolation, ±20 mA current I/O, 24 V digital logic levels, and digital debounce filters. Isolation prevents ground loops, rejects high common-mode voltages, and protects users and equipment from high-voltage transients. Four to 20 mA current loops are immune to most sources of electrical noise and voltage (IR) drops along extensive cable lengths. Sourcing or sinking 24 V digital I/O interfaces directly with pumps, valves, relays, and other industry-standard sensors and actuators; programmable debounce filters remove glitches and spikes from switches and relays connected to digital input lines.

Recommended Accessories

Signal conditioning is required for sensor measurements or voltage inputs greater than 10 V. NI SCXI is a versatile, high-performance signal conditioning platform optimized for high-channel-count applications. NI SCC provides portable, flexible signal conditioning options on a per-channel basis. Visit ni.com/sigcon for NI signal conditioning resources. The NI PCI-6221 (37-Pin) offers a 37-pin D-Sub connector that lowers connectivity costs by 80 percent. The D-Sub connector makes the PCI-6221 (37-Pin) ideal for OEM applications; however, its connector is not compatible with SCC or SCXI signal conditioning.

Recommended Driver Software

National Instruments measurement services software, built around NI-DAQmx driver software, includes intuitive application programming interfaces, configuration tools, I/O assistants, and other tools designed to reduce system setup, configuration, and development time. National Instruments recommends using the latest version of NI-DAQmx driver software for application development in NI LabVIEW and LabWindows™/CVI, ANSI C/C++, C#, Visual Basic .NET, and Visual Basic 6.0. To download the most recent version of NI-DAQmx software, visit ni.com/support/daq/versions. Linux and Mac OS X users can program M Series devices with NI-DAQmx Base driver software. M Series devices are compatible with the following versions (or later) of NI application software – LabVIEW, LabWindows/CVI, or Measurement Studio versions 7.x; LabVIEW SignalExpress 1.x; VI Logger 2.0; or LabVIEW with the LabVIEW Real-Time Module 7.1. M Series devices are not compatible with the Traditional NI-DAQ (Legacy) driver.

NI measurement services software speeds up your development with features including the following:

- A guide to create fast and accurate measurements with no programming using the DAQ Assistant
- Automatic code generation to create your application in LabVIEW; LabWindows/CVI; LabVIEW SignalExpress; and C#, Visual Studio .NET, ANSI C/C++, or Visual Basic using Measurement Studio
- Multithreaded streaming technology for 1,000 times performance improvements
- Automatic timing, triggering, and synchronization routing to make advanced applications easy
- Thousands of free software downloads available at ni.com/zone to jump-start your project
- Software configuration of all digital I/O features without hardware switches/jumpers
- Single programming interface for analog input, analog output, digital I/O, and counters on hundreds of multifunction DAQ hardware devices

M Series devices are compatible with the following versions (or later) of NI application software – LabVIEW, LabWindows/CVI, or Measurement Studio versions 7.x; and LabVIEW SignalExpress 2.x.

[Back to Top](#)

Ordering Information

For a complete list of accessories, visit the product page on ni.com.

[Back to Top](#)

Software Recommendations

LabVIEW Professional Development System for Windows



- Advanced software tools for large project development
- Automatic code generation using DAQ Assistant and Instrument I/O Assistant
- Tight integration with a wide range of hardware
- Advanced measurement analysis and digital signal processing
- Open connectivity with DLLs, ActiveX, and .NET objects
- Capability to build DLLs, executables, and MSI installers

SignalExpress for Windows

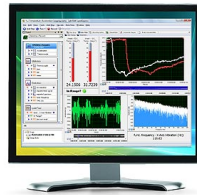

- Quickly configure projects without programming
- Control over 400 PC-based and stand-alone instruments
- Log data from more than 250 data acquisition devices
- Perform basic signal processing, analysis, and file I/O
- Scale your application with automatic LabVIEW code generation
- Create custom reports or easily export data to LabVIEW, DIAdem or Microsoft Excel

NI LabWindows™/CVI for Windows



- Real-time advanced 2D graphs and charts
- Complete hardware compatibility with IVI, VISA, DAQ, GPIB, and serial
- Analysis tools for array manipulation, signal processing statistics, and curve fitting
- Simplified cross-platform communication with network variables
- Measurement Studio .NET tools (included in LabWindows/CVI Full only)
- The mark LabWindows is used under a license from Microsoft Corporation.

NI Measurement Studio Professional Edition

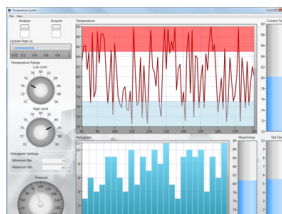

- Customizable graphs and charts for WPF, Windows Forms, and ASP.NET Web Forms UI design
- Analysis libraries for array operations, signal generation, windowing, filters, signal processing
- Hardware integration support with native .NET data acquisition and instrument control libraries
- Automatic code generation for all NI-DAQmx data acquisition hardware
- Intelligent and efficient data-logging libraries for streaming measurement data to disk
- Support for Microsoft Visual Studio .NET 2012/2010/2008

[Back to Top](#)

Support and Services

System Assurance Programs

NI system assurance programs are designed to make it even easier for you to own an NI system. These programs include configuration and deployment services for your NI PXI, CompactRIO, or Compact FieldPoint system. The NI Basic System Assurance Program provides a simple integration test and ensures that your system is delivered completely assembled in one box. When you configure your system with the NI Standard System Assurance Program, you can select from available NI system driver sets and application development environments to create customized, reorderable software configurations. Your system arrives fully assembled and tested in one box with your software preinstalled. When you order your system with the standard program, you also receive system-specific documentation including a bill of materials, an integration test report, a recommended maintenance plan, and frequently asked question documents. Finally, the standard program reduces the total cost of owning an NI system by providing three years of warranty coverage and calibration service. Use the online product advisors at ni.com/advisor to find a system assurance program to meet your needs.

Calibration

NI measurement hardware is calibrated to ensure measurement accuracy and verify that the device meets its published specifications. To ensure the ongoing accuracy of your measurement hardware, NI offers basic or detailed recalibration service that provides ongoing ISO 9001 audit compliance and confidence in your measurements. To learn more about NI calibration services or to locate a qualified service center near you, contact your local sales office or visit ni.com/calibration.

Technical Support

Get answers to your technical questions using the following National Instruments resources.

- **Support** - Visit ni.com/support to access the NI KnowledgeBase, example programs, and tutorials or to contact our applications engineers who are located in NI sales offices around the world and speak the local language.
- **Discussion Forums** - Visit forums.ni.com for a diverse set of discussion boards on topics you care about.
- **Online Community** - Visit community.ni.com to find, contribute, or collaborate on customer-contributed technical content with users like you.

Repair

While you may never need your hardware repaired, NI understands that unexpected events may lead to necessary repairs. NI offers repair services performed by highly trained technicians who quickly return your device with the guarantee that it will perform to factory specifications. For more information, visit ni.com/repair.

Training and Certifications

The NI training and certification program delivers the fastest, most certain route to increased proficiency and productivity using NI software and hardware. Training builds the skills to more efficiently develop robust, maintainable applications, while certification validates your knowledge and ability.

- **Classroom training in cities worldwide** - the most comprehensive hands-on training taught by engineers.
- **On-site training at your facility** - an excellent option to train multiple employees at the same time.
- **Online instructor-led training** - lower-cost, remote training if classroom or on-site courses are not possible.
- **Course kits** - lowest-cost, self-paced training that you can use as reference guides.
- **Training memberships** and training credits - to buy now and schedule training later.

Visit ni.com/training for more information.

Extended Warranty

NI offers options for extending the standard product warranty to meet the life-cycle requirements of your project. In addition, because NI understands that your requirements may change, the extended warranty is flexible in length and easily renewed. For more information, visit ni.com/warranty.

OEM

NI offers design-in consulting and product integration assistance if you need NI products for OEM applications. For information about special pricing and services for OEM customers, visit ni.com/oem.

Alliance

Our Professional Services Team is comprised of NI applications engineers, NI Consulting Services, and a worldwide National Instruments Alliance Partner program of more than 700 independent consultants and integrators. Services range from start-up assistance to turnkey system integration. Visit ni.com/alliance.

[Back to Top](#)

Detailed Specifications

Specifications listed below are typical at 25 °C unless otherwise noted. Refer to the *M Series User Manual* for more information about NI 622x devices.

Analog Input	
Number of channels	
NI 6220/6221	8 differential or 16 single ended
NI 6224/6229	16 differential or 32 single ended
NI 6225	40 differential or 80 single ended
ADC resolution	16 bits
DNL	No missing codes guaranteed
INL	Refer to the <i>AI Absolute Accuracy Table</i>
Sampling rate	
Maximum	250 kS/s single channel, 250 kS/s multi-channel (aggregate)
Minimum	No minimum
Timing accuracy	50 ppm of sample rate
Timing resolution	50 ns
Input coupling	DC
Input range	±10 V, ±5 V, ±1 V, ±0.2 V
Maximum working voltage for analog inputs (signal + common mode)	±11 V of AI GND
CMRR (DC to 60 Hz)	92 dB

Input impedance	
Device on	
AI+ to AI GND	>10 G Ω in parallel with 100 pF
AI- to AI GND	>10 G Ω in parallel with 100 pF
Device off	
AI+ to AI GND	820 Ω
AI- to AI GND	820 Ω
Input bias current	\pm 100 pA
Crosstalk (at 100 kHz)	
Adjacent channels	-75 dB
Non-adjacent channels	-90 dB ¹
Small signal bandwidth (-3 dB)	700 kHz
Input FIFO size	4,095 samples
Scan list memory	4,095 entries
Data transfers	
PCI/PXI devices	DMA (scatter-gather), interrupts, programmed I/O
USB devices	USB Signal Stream, programmed I/O
Overvoltage protection (AI <0..79>, AI SENSE, AI SENSE 2)	
Device on	\pm 25 V for up to two AI pins
Device off	\pm 15 V for up to two AI pins
Input current during overvoltage condition	\pm 20 mA max/AI pin

¹ For USB-6225 devices, channel AI <0..15> crosstalk to channel AI <64..79> is -71 dB; applies to channels with 64-channel separation, for example, AI (x) and AI (x + 64).

Settling Time for Multichannel Measurements

Accuracy, full scale step, all ranges

\pm 90 ppm of step (\pm 6 LSB)	4 μ s convert interval
\pm 30 ppm of step (\pm 2 LSB)	5 μ s convert interval
\pm 15 ppm of step (\pm 1 LSB)	7 μ s convert interval

Typical Performance Graphs

Settling Error Versus Time for Different Source Impedances

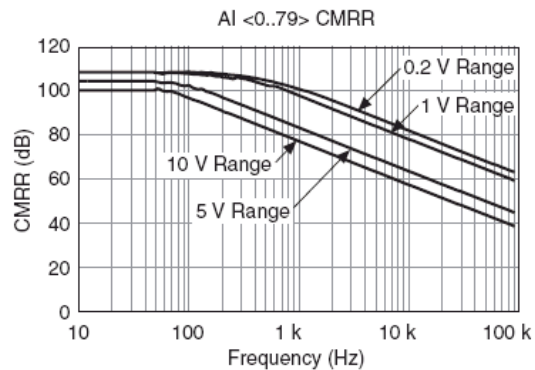
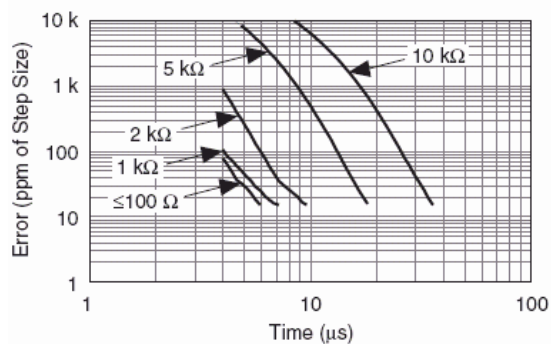

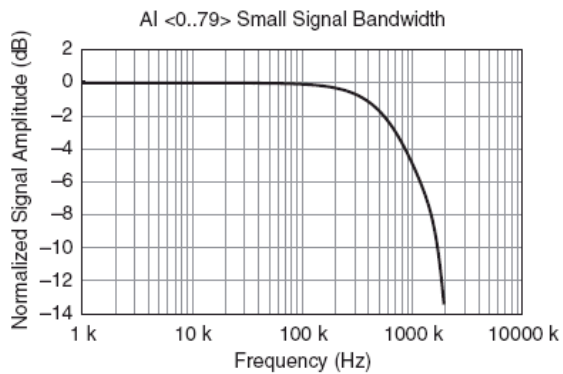

Analog Output

Number of channels

NI 6220/6224	0
NI 6221/6225	2
NI 6229	4

DAC resolution	16 bits
----------------	---------

DNL	±1 LSB
-----	--------

Monotonicity	16 bit guaranteed
--------------	-------------------

Maximum update rate

1 channel	833 kS/s
2 channels	740 kS/s per channel
3 channels	666 kS/s per channel
4 channels	625 kS/s per channel

Timing accuracy	50 ppm of sample rate
-----------------	-----------------------

Timing resolution	50 ns
-------------------	-------

Output range	±10 V
--------------	-------

Output coupling	DC
-----------------	----

Output impedance	0.2 Ω
------------------	-------

Output current drive	±5 mA
----------------------	-------

Overdrive protection	±25 V
----------------------	-------

Overdrive current	10 mA
-------------------	-------

Power-on state	±20 mV ²
----------------	---------------------

Power-on glitch	400 mV for 200 ms
-----------------	-------------------

Output FIFO size	8,191 samples shared among channels used
------------------	--

Data transfers

PCI/PXI devices	DMA (scatter-gather), interrupts, programmed I/O
-----------------	--

USB devices	USB Signal Stream, programmed I/O
-------------	-----------------------------------

AO waveform modes:

- Non-periodic waveform
- Periodic waveform regeneration mode from onboard FIFO
- Periodic waveform regeneration from host buffer including dynamic update

Settling time, full scale step 15 ppm (1 LSB)	6 μs
---	------

Slew rate	15 V/μs
-----------	---------

Glitch energy	
---------------	--

Magnitude	100 mV
-----------	--------

Duration	2.6 μs
----------	--------

² For all USB-6221/6229 Screw Terminal devices, when powered on, the analog output signal is not defined until after USB configuration is complete.

Calibration (AI and AO)

Recommended warm-up time 15 minutes

Calibration interval 1 year

AI Absolute Accuracy Table

Nominal Range		Residual Gain Error (ppm of Reading)	Gain Tempco (ppm/°C)	Reference Tempco	Residual Offset Error (ppm of Range)	Offset Tempco (ppm of Range/°C)	INL Error (ppm of Range)	Random Noise, σ (μ Vrms)	Absolute Accuracy at Full Scale ¹ (μ V)	Sensitivity ² (μ V)
Positive Full Scale	Negative Full Scale									
10	-10	75	25	5	20	57	76	244	3,100	97.6
5	-5	85	25	5	20	60	76	122	1,620	48.8
1	-1	95	25	5	25	79	76	30	360	12.0
0.2	-0.2	135	25	5	80	175	76	13	112	5.2

AbsoluteAccuracy = Reading · (GainError) + Range · (OffsetError) + NoiseUncertainty

GainError = ResidualGainError + GainTempco · (TempChangeFromLastInternalCal) + ReferenceTempco · (TempChangeFromLastExternalCal)

OffsetError = ResidualAIOffsetError + OffsetTempco · (TempChangeFromLastInternalCal) + INL_Error

NoiseUncertainty = $\frac{\text{RandomNoise} \cdot 3}{\sqrt{100}}$ For a coverage factor of 3 σ and averaging 100 points.

¹ Absolute accuracy at full scale on the analog input channels is determined using the following assumptions:

TempChangeFromLastExternalCal = 10 °C

TempChangeFromLastInternalCal = 1 °C

number_of_readings = 100

CoverageFactor = 3 σ

For example, on the 10 V range, the absolute accuracy at full scale is as follows:

GainError = 75 ppm + 25 ppm · 1 + 5 ppm · 10 GainError = 150 ppm

OffsetError = 20 ppm + 57 ppm · 1 + 76 ppm OffsetError = 153 ppm

NoiseUncertainty = $\frac{244 \mu\text{V} \cdot 3}{\sqrt{100}}$ NoiseUncertainty = 73 μ V

AbsoluteAccuracy = 10 V · (GainError) + 10 V · (OffsetError) + NoiseUncertainty AbsoluteAccuracy = 3,100 μ V

² Sensitivity is the smallest voltage change that can be detected. It is a function of noise.

Accuracies listed are valid for up to one year from the device external calibration.

AO Absolute Accuracy Table

Nominal Range		Residual Gain Error (ppm of Reading)	Gain Tempco (ppm/°C)	Reference Tempco	Residual Offset Error (ppm of Range)	Offset Tempco (ppm of Range/°C)	INL Error (ppm of Range)	Absolute Accuracy at Full Scale ¹ (μ V)
Positive Full Scale	Negative Full Scale							
10	-10	90	10	5	40	5	128	3,230

¹ Absolute Accuracy at full scale numbers is valid immediately following internal calibration and assumes the device is operating within 10 °C of the last external calibration. Accuracies listed are valid for up to one year from the device external calibration.

AbsoluteAccuracy = OutputValue · (GainError) + Range · (OffsetError)

GainError = ResidualGainError + GainTempco · (TempChangeFromLastInternalCal) + ReferenceTempco · (TempChangeFromLastExternalCal)

OffsetError = ResidualOffsetError + AOffsetTempco · (TempChangeFromLastInternalCal) + INL_Error

Digital I/O/PFI

Static Characteristics

Number of channels

NI 6220/6221 (68-pin)/6225	24 total 8 (P0.<0..7>) 16 (PFI <0..7>/P1, PFI <8..15>/P2)
PCI-6221 (37-pin)	10 total 2 (P0.<0, 1>) 8 (PFI <0..7>/P1)
NI 6224/6229	48 total 32 (P0.<0..31>) 16 (PFI <0..7>/P1, PFI <8..15>/P2)
Ground reference	D GND
Direction control	Each terminal individually programmable as input or output
Pull-down resistor	50 kΩ typical, 20 kΩ minimum
Input voltage protection ³	±20 V on up to two pins

³ Stresses beyond those listed under *Input voltage protection* may cause permanent damage to the device.

Waveform Characteristics (Port 0 Only)

Terminals used	
NI 6220/6221 (68-pin)/6225	Port 0 (P0.<0..7>)
PCI-6221 (37-pin)	Port 0 (P0.<0, 1>)
NI 6224/6229	Port 0 (P0.<0..31>)
Port/sample size	
NI 6220/6221 (68-pin)/6225	Up to 8 bits
PCI-6221 (37-pin)	Up to 2 bits
NI 6224/6229	Up to 32 bits
Waveform generation (DO) FIFO	2,047 samples
Waveform acquisition (DI) FIFO	2,047 samples
DI or DO Sample Clock frequency ⁴	0 to 1 MHz
Data transfers	
PCI/PXI devices	DMA (scatter-gather), interrupts, programmed I/O
USB devices	USB Signal Stream, programmed I/O
DO or DI Sample Clock source ⁵	Any PFI, RTSI, AI Sample or Convert Clock, AO Sample Clock, Ctr <i>n</i> Internal Output, and many other signals

⁴ Performance can be dependent on bus latency and volume of bus activity.

⁵ The digital subsystem does not have its own dedicated internal timing engine. Therefore, a sample clock must be provided from another subsystem on the device or an external source.

PFI/Port 1/Port 2 Functionality⁶

Functionality	Static digital input, static digital output, timing input, timing output
Timing output sources	Many AI, AO, counter, DI, DO timing signals
Debounce filter settings	125 ns, 6.425 μs, 2.56 ms, disable; high and low transitions; selectable per input

⁶ Port 2 is not available on PCI-6221 (37-pin) devices.

Recommended Operation Conditions, PCI/PXI Devices		
Level	Min	Max
Input high voltage (V_{IH})	2.2 V	5.25 V
Input low voltage (V_{IL})	0 V	0.8 V
Output high current (I_{OH})	—	-24 mA
P0.<0..31> PFI <0..15>/P1/P2	—	-16 mA
Output low current (I_{OL})	—	24 mA
P0.<0..31> PFI <0..15>/P1/P2	—	16 mA

Recommended Operation Conditions, USB Devices		
Level	Min	Max
Input high voltage (V_{IH})	2.2 V	5.25 V

Input low voltage (V_{IL})	0 V	0.8 V
Output high current (I_{OH})		
P0.<0..15>	—	-24 mA
P0.<16..31>	—	-16 mA
PFI <0..15>/P1/P2	—	-16 mA
Output low current (I_{OL})		
P0.<0..15>	—	24 mA
P0.<16..31>	—	16 mA
PFI <0..15>/P1/P2	—	16 mA

Electrical Characteristics		
Level	Min	Max
Positive-going threshold (V_{T+})	—	2.2 V
Negative-going threshold (V_{T-})	0.8 V	—
Delta VT hysteresis ($V_{T+} - V_{T-}$)	0.2 V	—
I_{IL} input low current ($V_{in} = 0$ V)	—	-10 μ A
I_{IH} input high current ($V_{in} = 5$ V)	—	250 μ A

Digital I/O Characteristics⁶

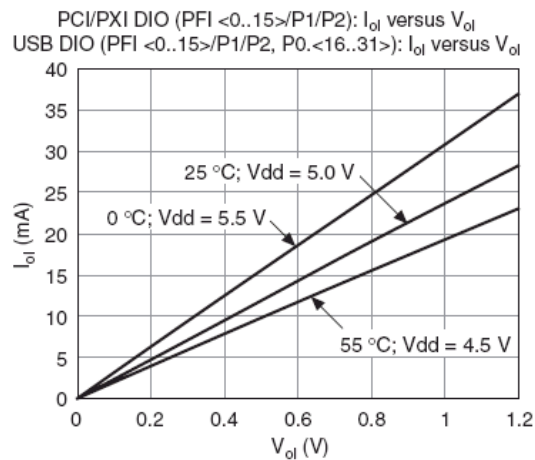
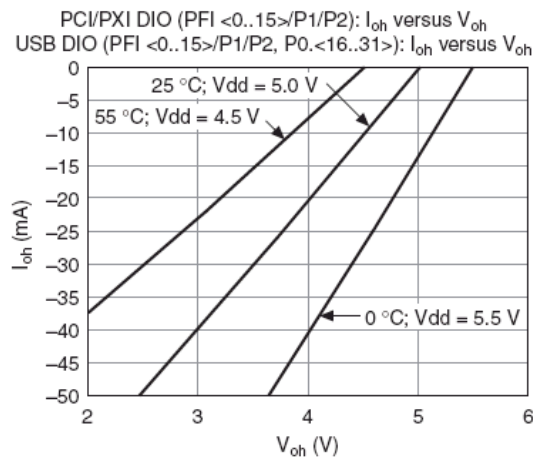
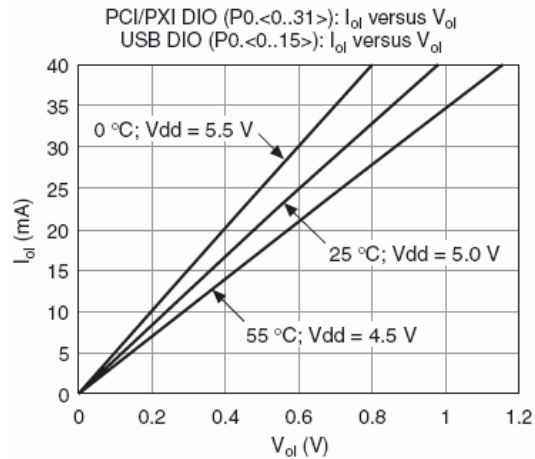
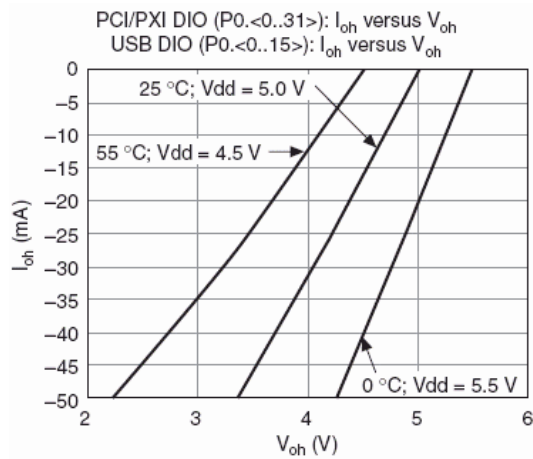

General-Purpose Counter/Timers

Number of counter/timers	2
Resolution	32 bits
Counter measurements	Edge counting, pulse, semi-period, period, two-edge separation
Position measurements	X1, X2, X4 quadrature encoding with Channel Z reloading; two-pulse encoding
Output applications	Pulse, pulse train with dynamic updates, frequency division, equivalent time sampling

Internal base clocks	80 MHz, 20 MHz, 0.1 MHz
External base clock frequency	0 MHz to 20 MHz
Base clock accuracy	50 ppm
Inputs	Gate, Source, HW_Arm, Aux, A, B, Z, Up_Down
Routing options for inputs	Any PFI, RTSI, PXI_TRIG, PXI_STAR, analog trigger, many internal signals
FIFO	2 samples
Data transfers	
PCI/PCIe/PXI/PXle devices	Dedicated scatter-gather DMA controller for each counter/timer; interrupts, programmed I/O
USB devices	USB Signal Stream, programmed I/O

Frequency Generator

Number of channels	1
Base clocks	10 MHz, 100 kHz
Divisors	1 to 16
Base clock accuracy	50 ppm

Output can be available on any PFI or RTSI terminal.

Phase-Locked Loop (PLL)

Number of PLLs	1
Reference signal	PXI_STAR, PXI_CLK10, RTSI <0..7>
Output of PLL	80 MHz Timebase; other signals derived from 80 MHz Timebase including 20 MHz and 100 kHz Timebases

External Digital Triggers

Source	Any PFI, RTSI, PXI_TRIG, PXI_STAR
Polarity	Software-selectable for most signals
Analog input function	Start Trigger, Reference Trigger, Pause Trigger, Sample Clock, Convert Clock, Sample Clock Timebase
Analog output function	Start Trigger, Pause Trigger, Sample Clock, Sample Clock Timebase
Counter/timer functions	Gate, Source, HW_Arm, Aux, A, B, Z, Up_Down
Digital waveform generation (DO) function	Sample Clock
Digital waveform acquisition (DI) function	Sample Clock

Device-To-Device Trigger Bus

PCI/PCIe devices	RTSI <0..7> ⁷
PXI/PXle devices	PXI_TRIG <0..7>, PXI_STAR
USB devices	None
Output selections	10 MHz Clock; frequency generator output; many internal signals
Debounce filter settings	125 ns, 6.425 μ s, 2.56 ms, disable; high and low transitions; selectable per input

⁷ In other sections of this document, *RTSI* refers to RTSI <0..7> for PCI devices or PXI_TRIG <0..7> for PXI devices.

Bus Interface

PCI/PXI devices	3.3 V or 5 V signal environment
USB devices	USB 2.0 Hi-Speed or full-speed ⁸
DMA channels (PCI/PXI devices)	6, analog input, analog output, digital input, digital output, counter/timer 0, counter/timer 1
USB Signal Stream (USB devices)	4, can be used for analog input, analog output, digital input, digital output, counter/timer 0, counter/timer 1

All PXI-625x devices support one of the following features:

- May be installed in PXI Express hybrid slots

▪ Or, may be used to control SCXI in PXI/SCXI combo chassis

⁸ If you are using a USB M Series device in full-speed mode, device performance will be lower and you will not be able to achieve maximum sampling/update rates.

M Series Device	M Series Part Number	SCXI Control in PXI/SCXI Combo Chassis	PXI Express Hybrid Slot Compatible
PXI-6220	191332B-04	No	Yes
PXI-6221	191332B-03	No	Yes
	191332B-13	Yes	No
PXI-6224	191332B-02	No	Yes
PXI-6225	192227A-01	No	Yes
PXI-6229	191332B-01	No	Yes
	191332B-11	Yes	No
Earlier versions of PXI-6220/6221/6224/6229	191332A-0x	Yes	No

Power Requirements

Current draw from bus during no-load condition⁹

PCI/PXI devices	
+5 V	0.02 A ¹⁰
+3.3 V	0.25 A ¹⁰
+12 V	0.15 A

Current draw from bus during AI and AO overvoltage condition⁹

PCI/PXI devices	
+5 V	0.02 A ¹⁰
+3.3 V	0.25 A ¹⁰
+12 V	0.25 A

 **Caution** USB-622x devices must be powered with NI offered AC adapter or a National Electric Code (NEC) Class 2 DC source that meets the power requirements for the device and has appropriate safety certification marks for country of use.

USB power supply requirements 11 to 30 VDC, 20 W, locking or non-locking power jack with 0.080" diameter center pin, 5/16-32 thread for locking collars

⁹ Does not include P0/PFI/P1/P2 and +5 V terminals.

¹⁰ PCI-6221 (37-pin) devices do not use +3.3 V from the bus. The 3.3 V current draw, shown in the *Power Requirements* section, comes from the +5 V instead.

Power Limits

 **Caution** Exceeding the power limits may cause unpredictable behavior by the device and/or PC/chassis.

PCI devices	
+5 V terminal (connector 0)	1 A max ¹¹
+5 V terminal (connector 1)	1 A max ¹¹
PXI devices	
+5 V terminal (connector 0)	1 A max ¹¹
+5 V terminal (connector 1)	1 A max ¹¹
P0/PFI/P1/P2 and +5 V terminals combined	2 A max
USB devices	
+5 V terminal	1 A max ¹¹
P0/PFI/P1/P2 and +5 V terminals combined	2 A max
Power supply fuse	2 A, 250 V

¹¹ Has a self-resetting fuse that opens when current exceeds this specification.

Physical Requirements

Printed circuit board dimensions	
PCI-6220/6221/6224/6225/6229	9.7 x 15.5 cm (3.8 x 6.1 in.)
PXI-6220/6221/6224/6225/6229	Standard 3U PXI

Enclosure dimensions (includes connectors)	
USB-6221/6225/6229 Screw Terminal	26.67 x 17.09 x 4.45 cm (10.5 x 6.73 x 1.75 in.)
USB-6221/6229 BNC	28.6 x 17 x 6.9 cm (11.25 x 6.7 x 2.7 in.)
USB-6225 Mass Termination	18.8 x 17.09 x 4.45 cm (7.4 x 6.73 x 1.75 in.)
USB-6221/6225/6229 OEM	Refer to the <i>NI USB-622x/625x OEM User Guide</i>
Weight	
PCI-6220	91 g (3.2 oz)
PCI-6221 (68-pin)	92 g (3.2 oz)
PCI-6221 (37-pin)	95 g (3.3 oz)
PCI-6224	99 g (3.5 oz)
PCI-6225	103 g (3.6 oz)
PCI-6229	101 g (3.5 oz)
PXI-6220	158 g (5.5 oz)
PXI-6221	162 g (5.7 oz)
PXI-6224	170 g (5.9 oz)
PXI-6225	174 g (6.1 oz)
PXI-6229	171 g (6.0 oz)
USB-6221 Screw Terminal	1.2 kg (2 lb 10 oz)
USB-6225/6229 Screw Terminal	1.24 kg (2 lb 11 oz)
USB-6225 Mass Termination	907 g (2 lb)
USB-6221 OEM	131 g (4.6 oz)
USB-6225/6229 OEM	162 g (5.7 oz)
I/O connector	
PCI/PXI-6220/6221 (68-pin)	1 68-pin VHDCI
PCI/PXI-6224/6225/6229	2 68-pin VHDCI
PCI-6221 (37-pin)	1 37-pin D-SUB
USB-6221 Screw Terminal	64 screw terminals
USB-6225/6229 Screw Terminal	128 screw terminals
USB-6221 BNC	21 BNCs and 30 screw terminals
USB-6229 BNC	32 BNCs and 60 screw terminals
USB-6225 Mass Termination	2 68-pin SCSI
USB-6221/6225/6229 Screw Terminal/ USB-6221/6229 BNC screw terminal wiring	16-28 AWG
Maximum Working Voltage¹²	
NI 6220/6221/6224/6225/6229 channel-to-earth	11 V, Measurement Category I
 Caution Do not use for measurements within Categories II, III, or IV.	
¹² <i>Maximum working voltage</i> refers to the signal voltage plus the common-mode voltage.	
Environmental	
Operating temperature	
PCI/PXI devices	0 to 55 °C
USB devices	0 to 45 °C
Storage temperature	-20 to 70 °C
Humidity	10 to 90% RH, noncondensing
Maximum altitude	2,000 m
Pollution Degree (indoor use only)	2
Shock and Vibration (PXI Devices Only)	

Operational shock	30 g peak, half-sine, 11 ms pulse (Tested in accordance with IEC-60068-2-27. Test profile developed in accordance with MIL-PRF-28800F.)
Random vibration	
Operating	5 to 500 Hz, 0.3 g _{rms}
Nonoperating	5 to 500 Hz, 2.4 g _{rms} (Tested in accordance with IEC-60068-2-64. Nonoperating test profile exceeds the requirements of MIL-PRF-28800F, Class 3.)

Safety

This product is designed to meet the requirements of the following standards of safety for electrical equipment for measurement, control, and laboratory use:

- IEC 61010-1, EN 61010-1
- UL 61010-1, CSA 61010-1



Note For UL and other safety certifications, refer to the product label or visit ni.com/certification, search by model number or product line, and click the appropriate link in the Certification column.

Electromagnetic Compatibility

This product is designed to meet the requirements of the following standards of EMC for electrical equipment for measurement, control, and laboratory use:

- EN 61326 EMC requirements; Minimum Immunity
- EN 55011 Emissions; Group 1, Class A
- CE, C-Tick, ICES, and FCC Part 15 Emissions; Class A



Note For EMC compliance, operate this device with shielded cables.

CE Compliance

This product meets the essential requirements of applicable European Directives, as amended for CE marking, as follows:

- 73/23/EEC; Low-Voltage Directive (safety)
- 89/336/EEC; Electromagnetic Compatibility Directive (EMC)



Note Refer to the Declaration of Conformity (DoC) for this product for any additional regulatory compliance information. To obtain the DoC for this product, visit ni.com/certification, search by model number or product line, and click the appropriate link in the Certification column.

Environmental Management

National Instruments is committed to designing and manufacturing products in an environmentally responsible manner. NI recognizes that eliminating certain hazardous substances from our products is beneficial not only to the environment but also to NI customers.

For additional environmental information, refer to the NI and the Environment Web page at ni.com/environment. This page contains the environmental regulations and directives with which NI complies, as well as other environmental information not included in this document.

Waste Electrical and Electronic Equipment (WEEE)



At the end of their life cycle, all products must be sent to a WEEE recycling center. For more information about WEEE recycling centers and National Instruments WEEE initiatives, visit ni.com/environment/weee.htm.

电子信息产品污染控制管理办法（中国 RoHS）



中国客户 National Instruments 符合中国电子信息产品中限制使用某些有害物质指令 (RoHS)。关于 National Instruments 中国 RoHS 合规性信息, 请登录 ni.com/environment/rohs_china。(For information about China RoHS compliance, go to ni.com/environment/rohs_china.)

[Back to Top](#)

Pinouts/Front Panel Connections

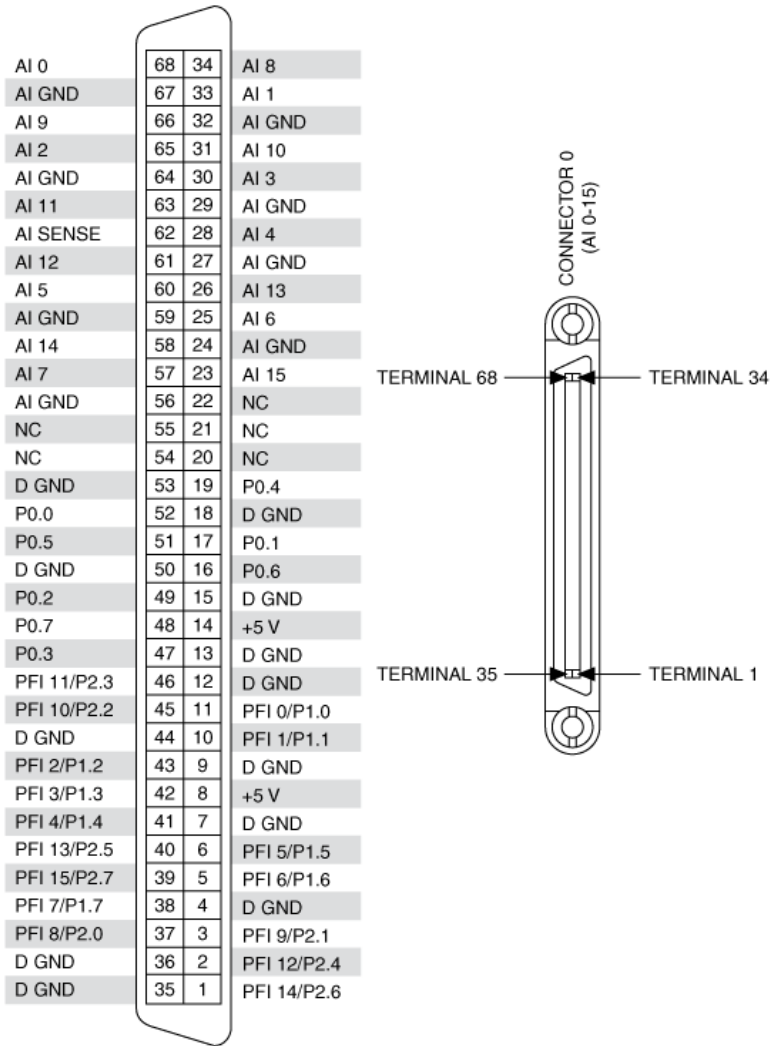

NC = No Connect

PCI/PXI-6220 Pinout

AI 0	68	34	AI 8
AI GND	67	33	AI 1
AI 9	66	32	AI GND
AI 2	65	31	AI 10
AI GND	64	30	AI 3
AI 11	63	29	AI GND
AI SENSE	62	28	AI 4
AI 12	61	27	AI GND
AI 5	60	26	AI 13
AI GND	59	25	AI 6
AI 14	58	24	AI GND
AI 7	57	23	AI 15
AI GND	56	22	AO 0
AO GND	55	21	AO 1
AO GND	54	20	NC
D GND	53	19	P0.4
P0.0	52	18	D GND
P0.5	51	17	P0.1
D GND	50	16	P0.6
P0.2	49	15	D GND
P0.7	48	14	+5 V
P0.3	47	13	D GND
PFI 11/P2.3	46	12	D GND
PFI 10/P2.2	45	11	PFI 0/P1.0
D GND	44	10	PFI 1/P1.1
PFI 2/P1.2	43	9	D GND
PFI 3/P1.3	42	8	+5 V
PFI 4/P1.4	41	7	D GND
PFI 13/P2.5	40	6	PFI 5/P1.5
PFI 15/P2.7	39	5	PFI 6/P1.6
PFI 7/P1.7	38	4	D GND
PFI 8/P2.0	37	3	PFI 9/P2.1
D GND	36	2	PFI 12/P2.4
D GND	35	1	PFI 14/P2.6

NC = No Connect

PCI/PXI-6221 (68-Pin) Pinout

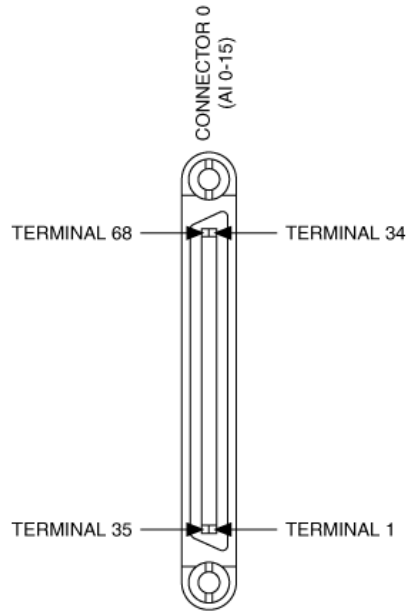

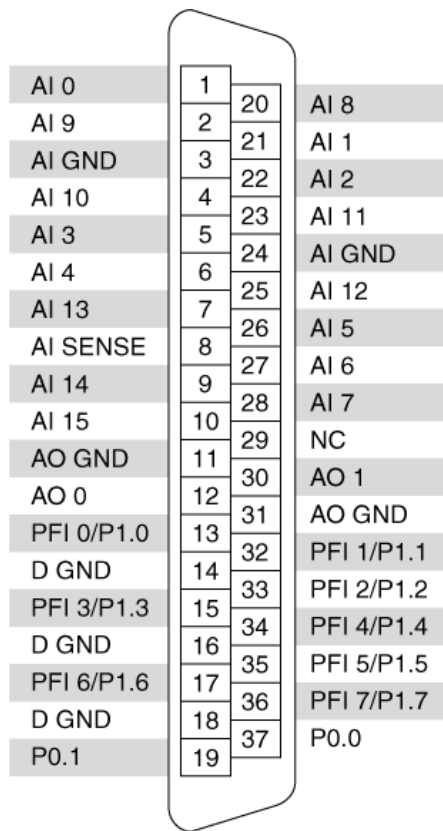

NC = No Connect

PCI-6221 (37-Pin) Pinout

AI 0	68	34	AI 8
AI GND	67	33	AI 1
AI 9	66	32	AI GND
AI 2	65	31	AI 10
AI GND	64	30	AI 3
AI 11	63	29	AI GND
AI SENSE	62	28	AI 4
AI 12	61	27	AI GND
AI 5	60	26	AI 13
AI GND	59	25	AI 6
AI 14	58	24	AI GND
AI 7	57	23	AI 15
AI GND	56	22	NC
NC	55	21	NC
NC	54	20	NC
D GND	53	19	P0.4
P0.0	52	18	D GND
P0.5	51	17	P0.1
D GND	50	16	P0.6
P0.2	49	15	D GND
P0.7	48	14	+5 V
P0.3	47	13	D GND
PFI 11/P2.3	46	12	D GND
PFI 10/P2.2	45	11	PFI 0/P1.0
D GND	44	10	PFI 1/P1.1
PFI 2/P1.2	43	9	D GND
PFI 3/P1.3	42	8	+5 V
PFI 4/P1.4	41	7	D GND
PFI 13/P2.5	40	6	PFI 5/P1.5
PFI 15/P2.7	39	5	PFI 6/P1.6
PFI 7/P1.7	38	4	D GND
PFI 8/P2.0	37	3	PFI 9/P2.1
D GND	36	2	PFI 12/P2.4
D GND	35	1	PFI 14/P2.6

NC = No Connect

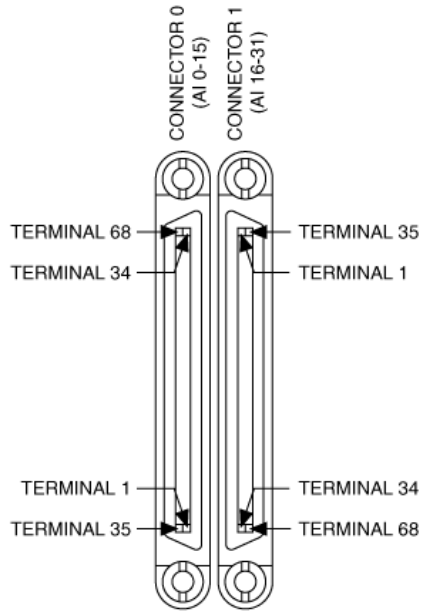

P0.30	1	35	D GND
P0.28	2	36	D GND
P0.25	3	37	P0.24
D GND	4	38	P0.23
P0.22	5	39	P0.31
P0.21	6	40	P0.29
D GND	7	41	P0.20
+5 V	8	42	P0.19
D GND	9	43	P0.18
P0.17	10	44	D GND
P0.16	11	45	P0.26
D GND	12	46	P0.27
D GND	13	47	P0.11
+5 V	14	48	P0.15
D GND	15	49	P0.10
P0.14	16	50	D GND
P0.9	17	51	P0.13
D GND	18	52	P0.8
P0.12	19	53	D GND
NC	20	54	NC
NC	21	55	NC
NC	22	56	AI GND
AI 31	23	57	AI 23
AI GND	24	58	AI 30
AI 22	25	59	AI GND
AI 29	26	60	AI 21
AI GND	27	61	AI 28
AI 20	28	62	AI SENSE 2
AI GND	29	63	AI 27
AI 19	30	64	AI GND
AI 26	31	65	AI 18
AI GND	32	66	AI 25
AI 17	33	67	AI GND
AI 24	34	68	AI 16

NC = No Connect

PCI/PXI-6224 Pinout

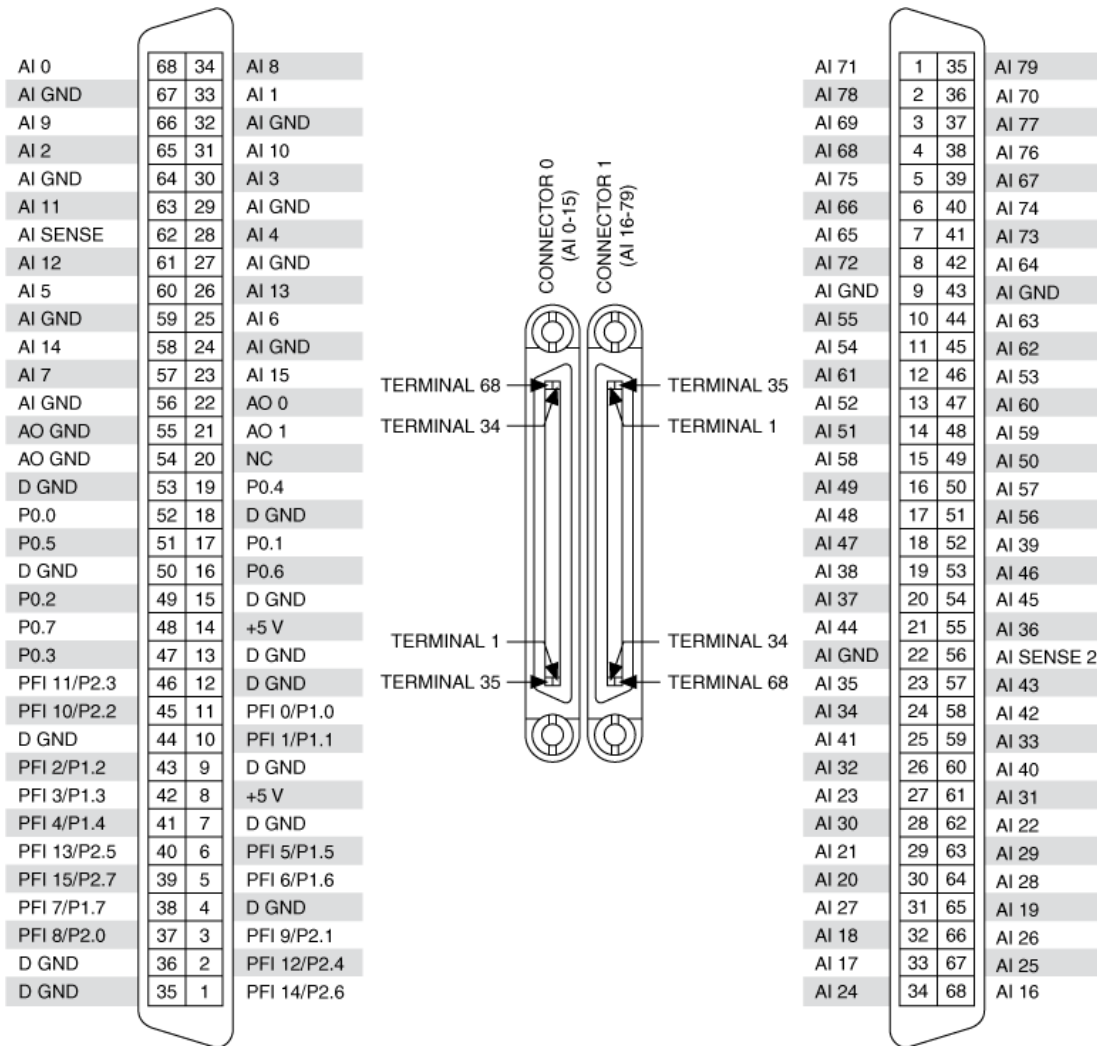

NC = No Connect

PCI/PXI-6225 Pinout

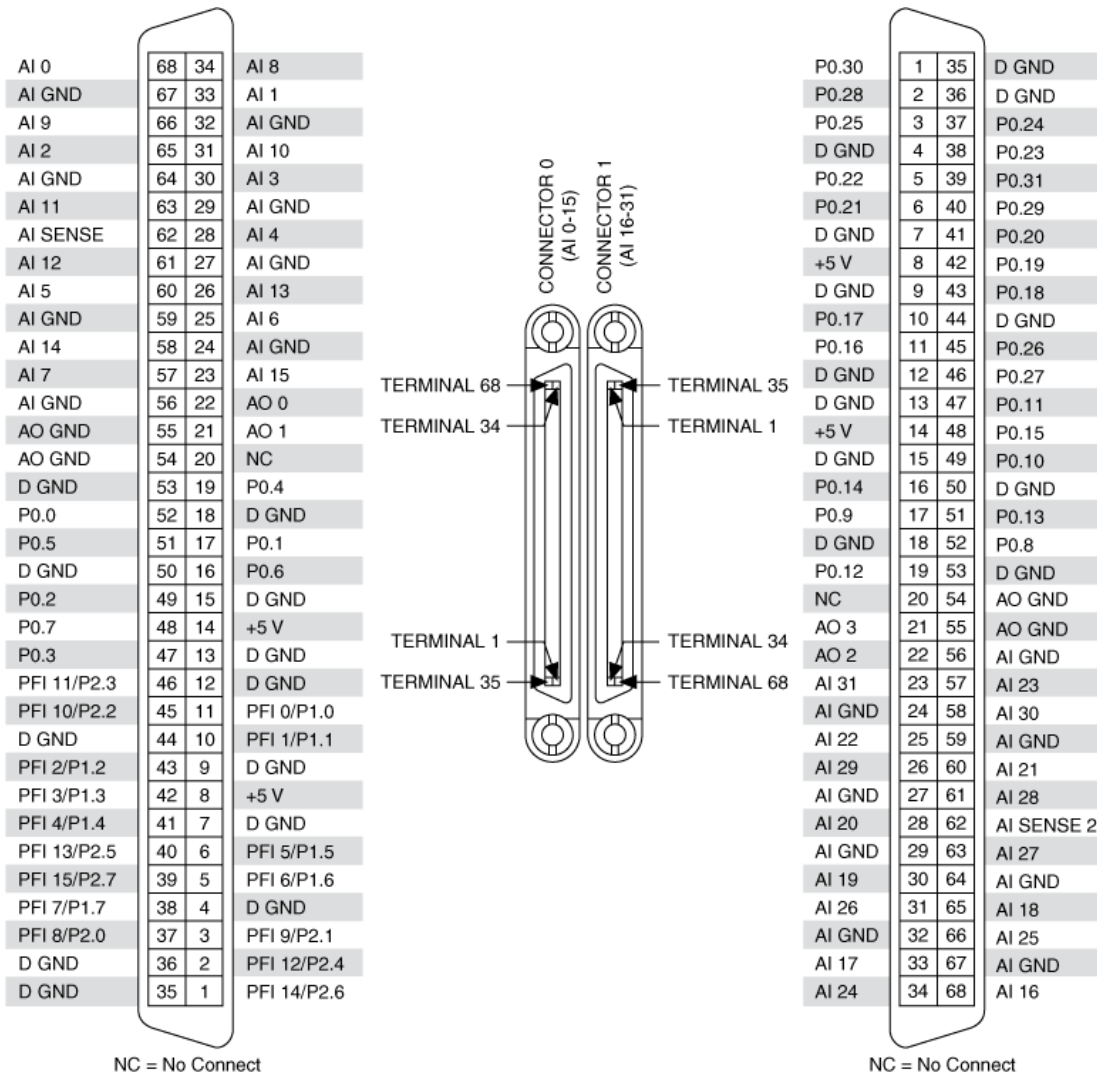

[Back to Top](#)

©2008 National Instruments. All rights reserved. CVI, LabVIEW, Measurement Studio, National Instruments, NI, ni.com, SCXI, and SignalExpress are trademarks of National Instruments. The mark LabWindows is used under a license from Microsoft Corporation. Windows is a registered trademark of Microsoft Corporation in the United States and other countries. Linux® is the registered trademark of Linus Torvalds in the U.S. and other countries. Other product and company names listed are trademarks or trade names of their respective companies.

[My Profile](#) | [RSS](#) | [Privacy](#) | [Legal](#) | [Contact NI](#) © 2014 National Instruments Corporation. All rights reserved.