

Features

- 1-channel isolated barrier
- 24 V DC supply (Power Rail)
- Dry contact or NAMUR inputs
- Usable as signal splitter (1 input and 2 outputs)
- Relay contact output
- Fault relay contact output
- Line fault detection (LFD)
- Reversible mode of operation
- Up to SIL 2 acc. to IEC 61508/IEC 61511

Function

This isolated barrier is used for intrinsic safety applications. It transfers digital signals (NAMUR sensors/mechanical contacts) from a hazardous area to a safe area.

The proximity sensor or switch controls a form C changeover relay contact for the safe area load. The normal output state can be reversed using switch S1. Switch S2 allows output II to be switched between a signal output or an error message output. Switch S3 is used to enable or disable line fault detection of the field circuit.

During an error condition, the relays revert to their de-energized state and the LEDs indicate the fault according to NAMUR NE44.

A unique collective error messaging feature is available when used with the Power Rail system.

Assembly

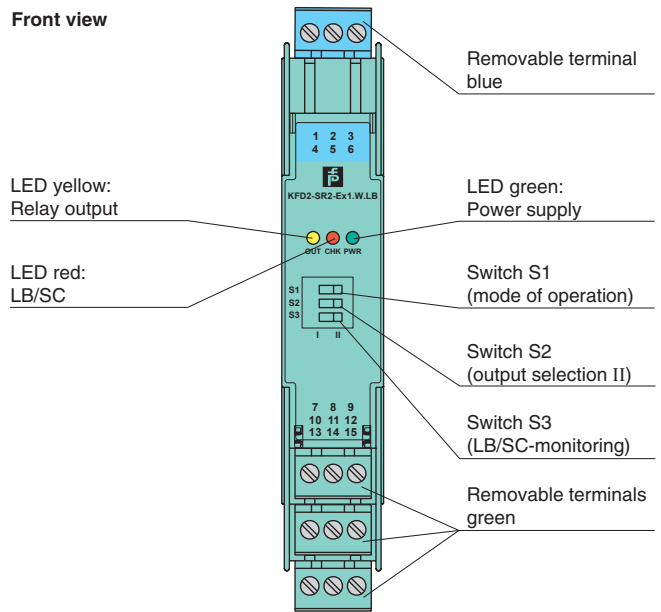

Connection

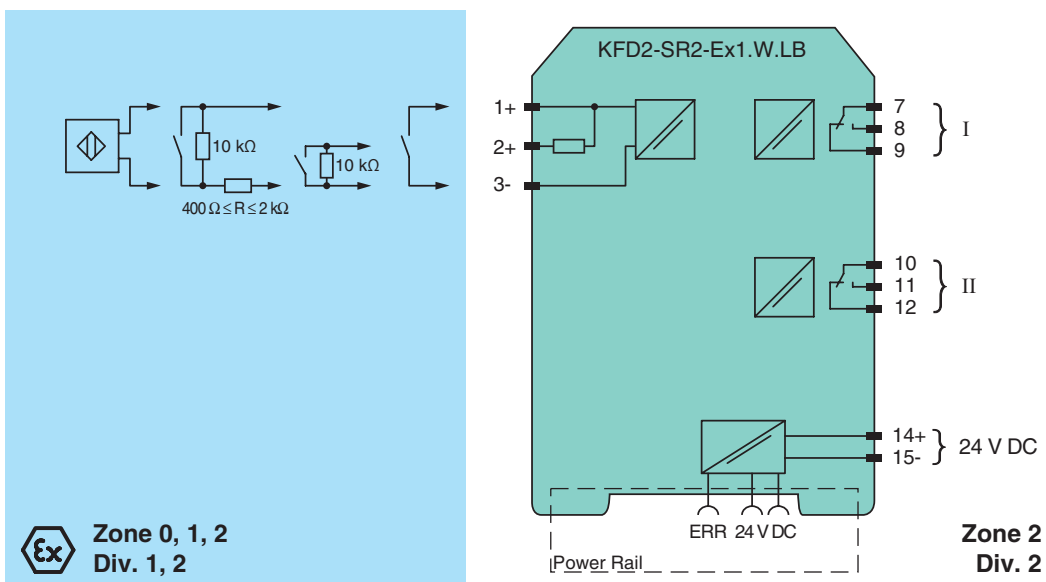

Release date 2018-06-19 07:42 Date of issue 2018-06-19 132959_eng.xml

Refer to "General Notes Relating to Pepperl+Fuchs Product Information".

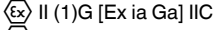
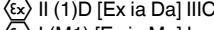
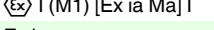
General specifications	
Signal type	Digital Input
Functional safety related parameters	
Safety Integrity Level (SIL)	SIL 2
Supply	
Connection	Power Rail or terminals 14+, 15-
Rated voltage U_r	20 ... 30 V DC
Ripple	≤ 10 %
Rated current I_r	≤ 50 mA
Power dissipation	1 W
Power consumption	< 1.3 W
Input	
Connection side	field side
Connection	terminals 1+, 2+, 3-
Rated values	acc. to EN 60947-5-6 (NAMUR)
Open circuit voltage/short-circuit current	approx. 8 V DC / approx. 8 mA
Switching point/switching hysteresis	1.2 ... 2.1 mA / approx. 0.2 mA
Line fault detection	breakage $I \leq 0.1$ mA , short-circuit $I > 6$ mA
Pulse/Pause ratio	≥ 20 ms / ≥ 20 ms
Output	
Connection side	control side
Connection	output I: terminals 7, 8, 9 ; output II: terminals 10, 11, 12
Output I	signal ; relay
Output II	signal or error message ; relay
Contact loading	253 V AC/2 A/cos $\phi > 0.7$; 126.5 V AC/4 A/cos $\phi > 0.7$; 40 V DC/2 A resistive load
Minimum switch current	2 mA / 24 V DC
Energized/De-energized delay	approx. 20 ms / approx. 20 ms
Mechanical life	10 ⁷ switching cycles
Transfer characteristics	
Switching frequency	≤ 10 Hz
Galvanic isolation	
Input/Output	reinforced insulation according to IEC/EN 61010-1, rated insulation voltage 300 V _{eff}
Input/power supply	reinforced insulation according to IEC/EN 61010-1, rated insulation voltage 300 V _{eff}
Output/power supply	reinforced insulation according to IEC/EN 61010-1, rated insulation voltage 300 V _{eff}
Output/Output	reinforced insulation according to IEC/EN 61010-1, rated insulation voltage 300 V _{eff}
Indicators/settings	
Display elements	LEDs
Control elements	DIP-switch
Configuration	via DIP switches
Labeling	space for labeling at the front
Directive conformity	
Electromagnetic compatibility	
Directive 2014/30/EU	EN 61326-1:2013 (industrial locations)
Low voltage	
Directive 2014/35/EU	EN 61010-1:2010
Conformity	
Electromagnetic compatibility	NE 21:2006
Degree of protection	IEC 60529:2001
Input	EN 60947-5-6:2000
Ambient conditions	
Ambient temperature	-20 ... 60 °C (-4 ... 140 °F)
Mechanical specifications	
Degree of protection	IP20
Connection	screw terminals
Mass	approx. 150 g
Dimensions	20 x 119 x 115 mm (0.8 x 4.7 x 4.5 inch) , housing type B2
Mounting	on 35 mm DIN mounting rail acc. to EN 60715:2001
Data for application in connection with hazardous areas	
EU-Type Examination Certificate	PTB 00 ATEX 2080
Marking	  
Input	Ex ia
Voltage U_o	10.5 V

Release date 2018-06-19 07:42 Date of issue 2018-06-19 132959_eng.xml

Refer to "General Notes Relating to Pepperl+Fuchs Product Information".

Pepperl+Fuchs Group
www.pepperl-fuchs.com

USA: +1 330 486 0002
pa-info@us.pepperl-fuchs.com

Germany: +49 621 776 2222
pa-info@de.pepperl-fuchs.com

Singapore: +65 6779 9091
pa-info@sg.pepperl-fuchs.com

Current	I_o	13 mA
Power	P_o	34 mW (linear characteristic)
Supply		
Maximum safe voltage	U_m	253 V AC / 125 V DC (Attention! U_m is no rated voltage.)
Output		
Contact loading		253 V AC/2 A/cos $\phi > 0.7$; 126.5 V AC/4 A/cos $\phi > 0.7$; 40 V DC/2 A resistive load
Maximum safe voltage	U_m	253 V AC (Attention! The rated voltage can be lower.)
Fault indication output		
Maximum safe voltage	U_m	40 V DC (Attention! U_m is no rated voltage.)
Certificate		
Marking		PF 08 CERT 0803
Input		Ex ic
Voltage	U_o	10.5 V
Current	I_o	13 mA
Power	P_o	34 mW (linear characteristic)
Output		
Contact loading		253 V AC/2 A/cos $\phi > 0.7$; 126.5 V AC/4 A/cos $\phi > 0.7$; 40 V DC/2 A resistive load
Certificate		
Marking		TÜV 99 ATEX 1493 X
Output		Ex II 3G Ex nA nC IIC T4
Contact loading		50 V AC/4 A/cos $\phi > 0.7$; 40 V DC/2 A resistive load
Galvanic isolation		
Input/Output		safe electrical isolation acc. to IEC/EN 60079-11, voltage peak value 375 V
Input/power supply		safe electrical isolation acc. to IEC/EN 60079-11, voltage peak value 375 V
Directive conformity		
Directive 2014/34/EU		EN 60079-0:2012+A11:2013 , EN 60079-11:2012 , EN 60079-15:2010
International approvals		
FM approval		
Control drawing		116-0035
UL approval		
Control drawing		116-0145
CSA approval		
Control drawing		116-0047
IECEX approval		
Approved for		[Ex ia Ga] IIC, [Ex ia Da] IIIC, [Ex ia Ma] I
General information		
Supplementary information		Observe the certificates, declarations of conformity, instruction manuals, and manuals where applicable. For information see www.pepperl-fuchs.com .

Configuration

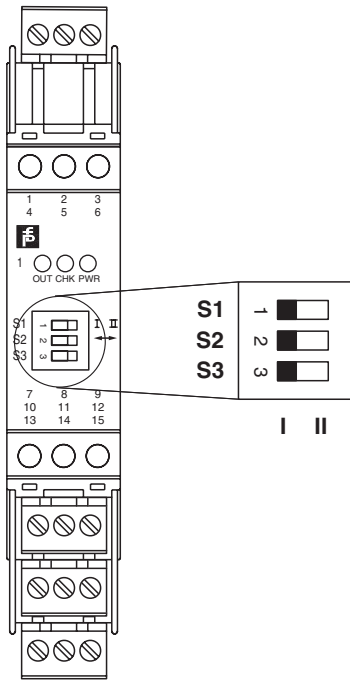

Switch position

S	Function		Position
1	Mode of operation Output I (relay) energized	with high input current	I
		with low input current	II
2	Assignment Output II (relay)	switching state like output I	I
		fault signal output (de-energized if fault)	II
3	Line fault detection	ON	I
		OFF	II

Operating status

Control circuit	Input signal
Initiator high impedance/ contact opened	low input current
Initiator low impedance/ contact closed	high input current
Lead breakage, lead short-circuit	Line fault

Factory settings: switch 1, 2 and 3 in position I

Maximum switching power of output contacts

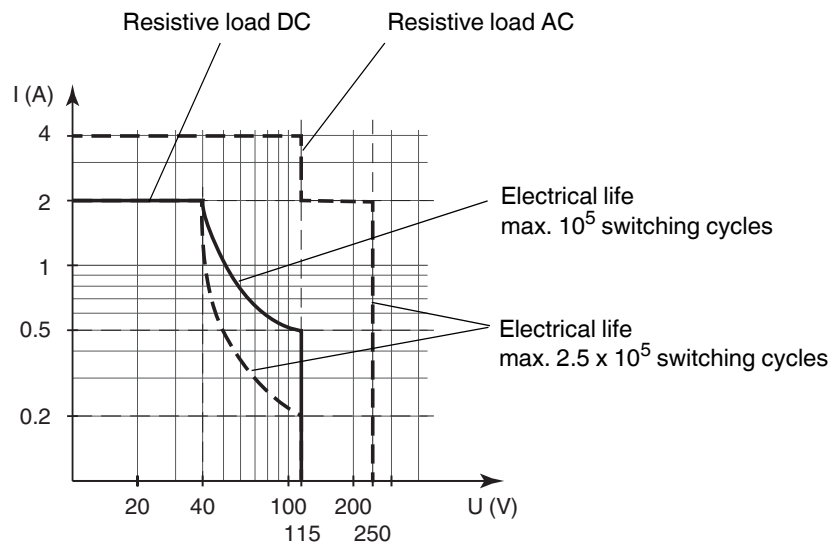

The maximum number of switching cycles is depending on the electrical load and may be higher when reduced currents and voltages are applied.

Accessories

Power feed module KFD2-EB2

The power feed module is used to supply the devices with 24 V DC via the Power Rail. The fuse-protected power feed module can supply up to 150 individual devices depending on the power consumption of the devices. Collective error messages received from the Power Rail activate a galvanically-isolated mechanical contact.

Power Rail UPR-03

The Power Rail UPR-03 is a complete unit consisting of the electrical insert and an aluminium profile rail 35 mm x 15 mm. To make electrical contact, the devices are simply engaged.

Profile Rail K-DUCT with Power Rail

The profile rail K-DUCT is an aluminum profile rail with Power Rail insert and two integral cable ducts for system and field cables. Due to this assembly no additional cable guides are necessary.



Power Rail and Profile Rail must not be fed via the device terminals of the individual devices!

Release date 2018-06-19 07:42 Date of issue 2018-06-19 132959_eng.xml

Refer to "General Notes Relating to Pepperl+Fuchs Product Information".