

Inductive sensor NCN40-L2-N0-V1

- Sensor head bidirectional and rotatable
- 40 mm non-flush
- Quick mounting bracket
- Usable up to SIL 2 acc. to IEC 61508

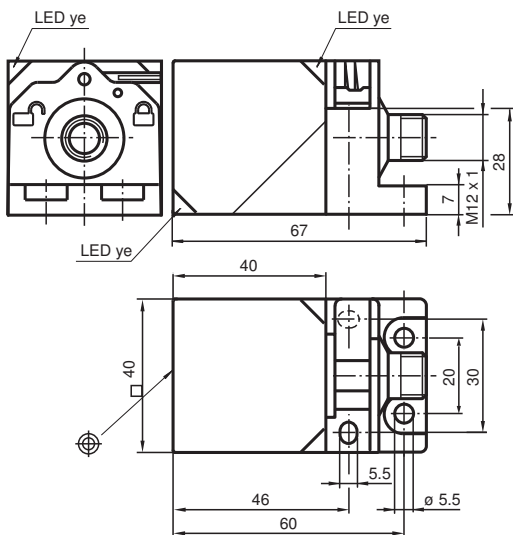

Dimensions



Technical Data

General specifications

Switching function		Normally closed (NC)
Output type		NAMUR
Rated operating distance	s_n	40 mm
Installation		non-flush
Assured operating distance	s_a	0 ... 32.4 mm
Actual operating distance	s_r	36 ... 44 mm
Reduction factor r_{AI}		0.31
Reduction factor r_{Cu}		0.3
Reduction factor r_{304}		0.74

Nominal ratings

Nominal voltage	U_o	8.2 V (R_i approx. 1 k Ω)
Switching frequency	f	0 ... 150 Hz
Hysteresis	H	typ. 5 %

Release date: 2020-12-14 Date of issue: 2020-12-14 Filename: 182706_eng.pdf

Refer to "General Notes Relating to Pepperl+Fuchs Product Information".

Pepperl+Fuchs Group
www.pepperl-fuchs.com

USA: +1 330 486 0001
fa-info@us.pepperl-fuchs.com

Germany: +49 621 776 1111
fa-info@de.pepperl-fuchs.com

Singapore: +65 6779 9091
fa-info@sg.pepperl-fuchs.com

 PEPPERL+FUCHS

Technical Data

Reverse polarity protection		reverse polarity protected
Short-circuit protection		yes
Current consumption		
Measuring plate not detected		≥ 2.2 mA
Measuring plate detected		≤ 1 mA
Switching state indicator		LED, yellow
Functional safety related parameters		
MTTF _d		1670 a
Mission Time (T _M)		20 a
Diagnostic Coverage (DC)		0 %
Compliance with standards and directives		
Standard conformity		
Standards		EN 60947-5-2:2007 EN 60947-5-2/A1:2012 IEC 60947-5-2:2007 IEC 60947-5-2 AMD 1:2012
Approvals and certificates		
IECEX approval		
Equipment protection level Ga		IECEX PTB 11.0021X
Equipment protection level Gb		IECEX PTB 11.0021X
Equipment protection level Da		IECEX PTB 11.0021X
Equipment protection level Mb		IECEX PTB 11.0021X
ATEX approval		
Equipment protection level Ga		PTB 00 ATEX 2032 X
Equipment protection level Gb		PTB 00 ATEX 2032 X
Equipment protection level Gc (ic)		PF13CERT2895 X
Equipment protection level Da		PTB 00 ATEX 2032 X
Equipment protection level Dc (tc)		PF15CERT3774X
EAC conformity		
Protection class		II
Rated insulation voltage	U _i	253 V
Rated impulse withstand voltage	U _{imp}	4000 V
UL approval		
Ordinary Location		E87056
Hazardous Location		E501628
Control drawing		116-0451
CCC approval		
Hazardous Location		2020322315002302
NEPSI approval		
NEPSI certificate		GYJ16.1394X
Marine approval		
		DNVGL TAA00001A5
Ambient conditions		
Ambient temperature		-25 ... 100 °C (-13 ... 212 °F)
Storage temperature		-40 ... 100 °C (-40 ... 212 °F)
Mechanical specifications		
Connection type		Connector plug M12 x 1 , 4-pin
Housing material		PA
Sensing face		PA
Degree of protection		IP69K
Mass		130 g
General information		
Use in the hazardous area		see instruction manuals

Release date: 2020-12-14 Date of issue: 2020-12-14 Filename: 182706_eng.pdf

Refer to "General Notes Relating to Pepperl+Fuchs Product Information".

Pepperl+Fuchs Group
www.pepperl-fuchs.comUSA: +1 330 486 0001
fa-info@us.pepperl-fuchs.comGermany: +49 621 776 1111
fa-info@de.pepperl-fuchs.comSingapore: +65 6779 9091
fa-info@sg.pepperl-fuchs.com

PEPPERL+FUCHS

Connection

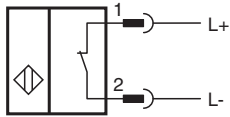





Connection Assignment



Wire colors in accordance with EN 60947-5-6

1	BN	(brown)
2	BU	(blue)

Accessories

	V1-G-N-2M-PUR	Female cordset single-ended M12 straight A-coded, 2-pin, PUR cable blue, NAMUR
	V1-W-N-2M-PUR	Female cordset single-ended M12 angled A-coded, 2-pin, PUR cable blue, NAMUR
	MHW 01	Modular mounting bracket
	KCD2-SR-Ex1.LB	24 V DC
	KCD2-E2L	Sensor output interface terminal with lead breakage monitoring

Release date: 2020-12-14 Date of issue: 2020-12-14 Filename: 182706_eng.pdf