

AB-SK TOP - Support bracket



3062090

<https://www.phoenixcontact.com/de/produkte/3062090>

Please be informed that the data shown in this PDF document is generated from our online catalog. Please find the complete data in the user documentation. Our general terms of use for downloads are valid.

Support bracket, Bracket for busbars, set every 20 cm, width: 5.2 mm, height: 102.4 mm, number of positions: 1, color: gray, mounting type: DIN rail mounting



Your advantages

- For mounting SK and SKS shield connection clamps
- Can be labeled with zack marker strip and KLM terminal strip markers
- Compact design with 5.2 mm pitch
- Parking option for FBS plug-in bridges
- For user-friendly shield connection, especially for single and multi-level terminal blocks and devices with a front connection
- The 3 x 10 mm rail can be mounted in the supports vertically, horizontally, and at a 45° angle for optimum conductor placement
- End bracket function

Commercial data

Item number	3062090
Packing unit	10 pc
Minimum order quantity	10 pc
Sales key	B1 - Markierung Montage
Product key	BE7113
Catalog page	Page 570 (C-3-2019)
GTIN	4046356592086
Weight per piece (including packing)	17,69 g
Weight per piece (excluding packing)	14,273 g
Customs tariff number	39269097
Country of origin	CN

AB-SK TOP - Support bracket

3062090

<https://www.phoenixcontact.com/de/produkte/3062090>

Technical data

Notes

General	direct contact with NS 35
---------	---------------------------

Product properties

Product type	Support
Number of positions	1

Electrical properties

Nominal current I_N	0 A
-----------------------	-----

Dimensions

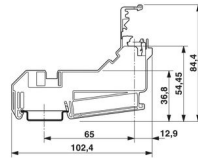
Dimensional drawing	
Width	5.2 mm
Height	102.4 mm
Depth on NS 35/7,5	63.2 mm
Depth on NS 35/15	70.7 mm

Material specifications

Color	gray
Material	PA
Insulating material	PA
Static insulating material application in cold	-60 °C
Temperature index of insulating material (DIN EN 60216-1 (VDE 0304-21))	130 °C
Relative insulation material temperature index (Elec., UL 746 B)	130 °C

Environmental and real-life conditions

Ambient conditions

Ambient temperature (operation)	-60 °C ... 105 °C (max. short-term operating temperature RTI Elec.)
Ambient temperature (storage/transport)	-25 °C ... 60 °C (for a short time, not exceeding 24 h, -60 °C to +70 °C)
Ambient temperature (assembly)	-5 °C ... 70 °C
Ambient temperature (actuation)	-5 °C ... 70 °C
Permissible humidity (storage/transport)	30 % ... 70 %

Mounting

Mounting type	DIN rail mounting
---------------	-------------------

AB-SK TOP - Support bracket

3062090

<https://www.phoenixcontact.com/de/produkte/3062090>



Drawings

Dimensional drawing

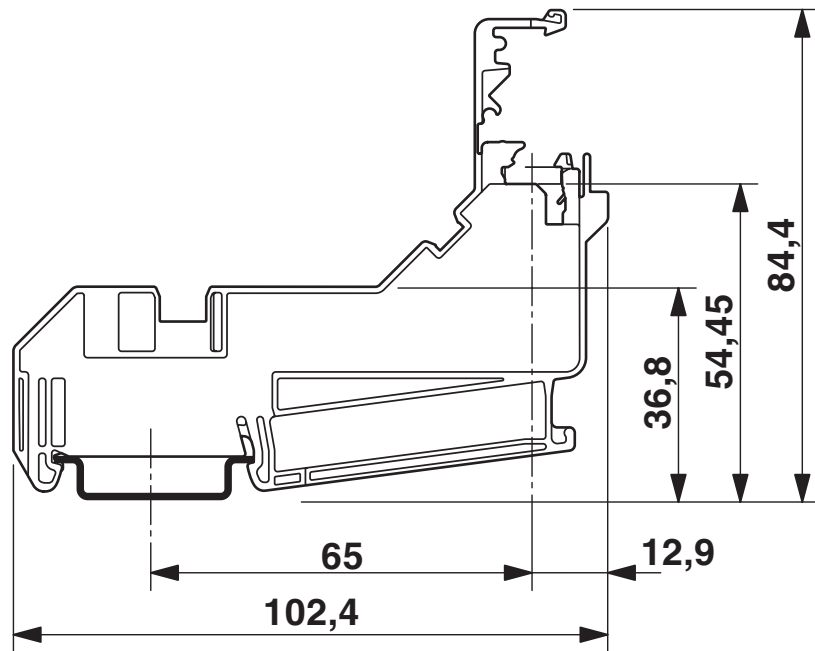

AB-SK TOP - Support bracket



3062090

<https://www.phoenixcontact.com/de/produkte/3062090>

Classifications

ECLASS

ECLASS-11.0	27400607
ECLASS-12.0	27400607
ECLASS-13.0	27400607

ETIM

ETIM 9.0	EC001166
----------	----------

UNSPSC

UNSPSC 21.0	39121700
-------------	----------

AB-SK TOP - Support bracket

3062090

<https://www.phoenixcontact.com/de/produkte/3062090>



Environmental product compliance

China RoHS	Environmentally friendly use period: unlimited = EFUP-e
	No hazardous substances above threshold values

AB-SK TOP - Support bracket

3062090

<https://www.phoenixcontact.com/de/produkte/3062090>



Accessories

NLS-CU 3/10 SN 55MM 2X5,5 - Neutral busbar

5406304

<https://www.phoenixcontact.com/de/produkte/5406304>

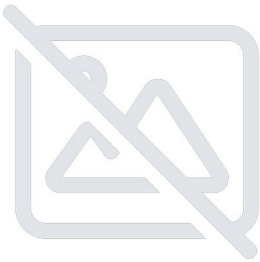

Neutral busbar, material: Copper, tin-plated

NLS-CU 3/10 SN 300MM 2X5,2 - Neutral busbar

5406221

<https://www.phoenixcontact.com/de/produkte/5406221>

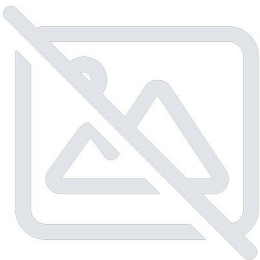

Neutral busbar

AB-SK TOP - Support bracket

3062090

<https://www.phoenixcontact.com/de/produkte/3062090>



NLS-CU 3/10 SN 175MM - Neutral busbar

5406194

<https://www.phoenixcontact.com/de/produkte/5406194>

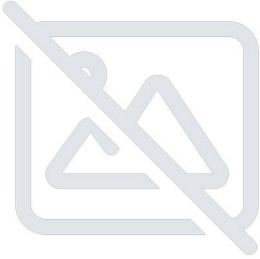

Neutral busbar

NLS-CU 3/10 SN 630MM - Neutral busbar

5406185

<https://www.phoenixcontact.com/de/produkte/5406185>

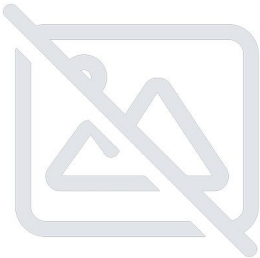

Neutral busbar, material: Copper, tin-plated

AB-SK TOP - Support bracket

3062090

<https://www.phoenixcontact.com/de/produkte/3062090>



NLS-CU 3/10 SN 550MM - Neutral busbar

5406184

<https://www.phoenixcontact.com/de/produkte/5406184>

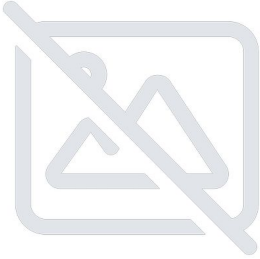

Neutral busbar, material: Copper, tin-plated

NLS-CU 3/10 SN 1550MM - Neutral busbar

5406170

<https://www.phoenixcontact.com/de/produkte/5406170>

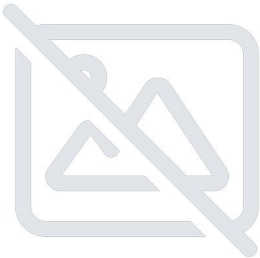

Neutral busbar, material: Copper, tin-plated

AB-SK TOP - Support bracket

3062090

<https://www.phoenixcontact.com/de/produkte/3062090>



NLS-CU 3/10 SN 93MM - Neutral busbar

5406159

<https://www.phoenixcontact.com/de/produkte/5406159>

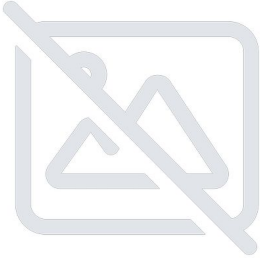

Neutral busbar, material: Copper, tin-plated

NLS-CU 3/10 16.31.19.040-AA - Neutral busbar

5405865

<https://www.phoenixcontact.com/de/produkte/5405865>

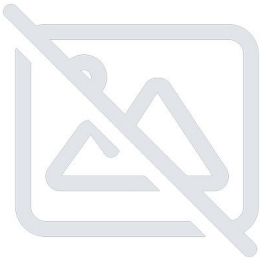

Neutral busbar, material: Copper, tin-plated

AB-SK TOP - Support bracket

3062090

<https://www.phoenixcontact.com/de/produkte/3062090>



NLS-CU 3/10 95MM ZG.160452 - Neutral busbar

5405857

<https://www.phoenixcontact.com/de/produkte/5405857>

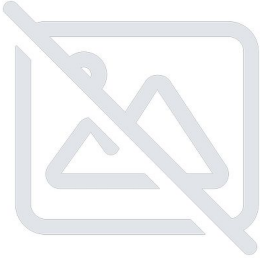

Neutral busbar, material: Copper, tin-plated

NLS-CU 3/10 58MM ZG.155646 - Neutral busbar

5405855

<https://www.phoenixcontact.com/de/produkte/5405855>

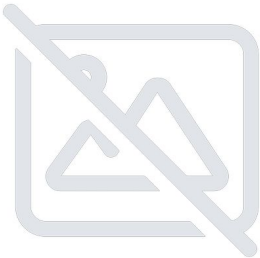

Neutral busbar, material: Copper, tin-plated

AB-SK TOP - Support bracket

3062090

<https://www.phoenixcontact.com/de/produkte/3062090>



NLS-CU 3/10 SN 90MM LANG - Neutral busbar

5405836

<https://www.phoenixcontact.com/de/produkte/5405836>

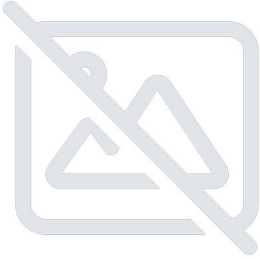

Neutral busbar, material: Copper, tin-plated

NLS-CU 3/10 245MM LG - Neutral busbar

5405831

<https://www.phoenixcontact.com/de/produkte/5405831>

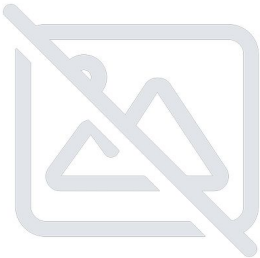

Neutral busbar, material: Copper, tin-plated

AB-SK TOP - Support bracket

3062090

<https://www.phoenixcontact.com/de/produkte/3062090>



NLS 3/10 AV 134/134 - Neutral busbar

3062870

<https://www.phoenixcontact.com/de/produkte/3062870>



Angled rail for holding the C-NBB busbar connector

NLS-CU 3/10 SN 150MM 2X3,5 - Neutral busbar

1044718

<https://www.phoenixcontact.com/de/produkte/1044718>

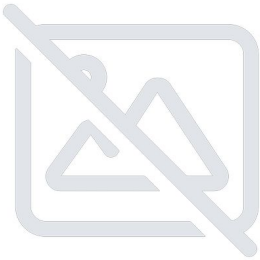

PEN conductor busbar, 3 mm x 10 mm

AB-SK TOP - Support bracket

3062090

<https://www.phoenixcontact.com/de/produkte/3062090>



NLS-CU 3/10 220MM 4X4,5 1XM4 - Neutral busbar

1013677

<https://www.phoenixcontact.com/de/produkte/1013677>



PEN conductor busbar, 3 mm x 10 mm

NLS-CU 3/10 SN 1000MM - Neutral busbar

0402174

<https://www.phoenixcontact.com/de/produkte/0402174>



Neutral busbar, DIN VDE 0611-4: 1991-02, material: Copper, tin-plated, color: silver

AB-SK TOP - Support bracket

3062090

<https://www.phoenixcontact.com/de/produkte/3062090>



NLS-CU 3/10 SN 2000MM - Neutral busbar

0402006

<https://www.phoenixcontact.com/de/produkte/0402006>



Neutral busbar, DIN VDE 0611-4: 1991-02, material: Copper, tin-plated, color: silver

Phoenix Contact 2024 © - all rights reserved

<https://www.phoenixcontact.com>

PHOENIX CONTACT Deutschland GmbH

Flachsmarktstraße 8

D-32825 Blomberg

+49 52 35/3-1 20 00

info@phoenixcontact.de