

Signal conditioner - MINI MCR-2-I4-U-PT



2902003

<https://www.phoenixcontact.com/de/produkte/2902003>

Please be informed that the data shown in this PDF document is generated from our Online Catalog. Please find the complete data in the user documentation. Our General Terms of Use for Downloads are valid.



3-way signal conditioner with plug-in connection technology for the electrical isolation of analog signals. Input signal: 4 mA ... 20 mA, output signal: 0 V ... 10 V, push-in connection technology

Product Description

Standard signal 3-way signal conditioner with plug-in connection technology for the electrical isolation, conversion, amplification, and filtering of standard signals. The measuring transducer supports fault monitoring and NFC communication.

Commercial Data

Item number	2902003
Packing unit	1 pc
Minimum order quantity	1 pc
Sales Key	J1 - MSR-Technik
Product Key	CK1411
Catalog Page	Page 76 (C-5-2019)
GTIN	4063151174538
Weight per Piece (including packing)	107 g
Weight per Piece (excluding packing)	95,3 g
Customs tariff number	85437090
Country of origin	DE

Technical Data

Notes

Utilization restriction

EMC note	EMC: class A product, see manufacturer's declaration in the download area
----------	---

Product properties

Product type	Signal conditioner
No. of channels	1
Type	Signal conditioner

Insulation characteristics

Overvoltage category	II
Pollution degree	2

Electrical properties

No. of channels	1
Electrical isolation	3-way isolation
Electrical isolation between input and output	yes
Limit frequency (3 dB)	approx. 30 Hz
Protective circuit	Transient protection
Step response (10-90%)	approx. 10 ms
Maximum temperature coefficient	0.01 %/K
Temperature coefficient, typical	0.01 %/K
Maximum transmission error	0.1 % (of final value)

Electrical isolation Input/output/power supply

Rated insulation voltage	300 V _{rms}
Test voltage	3 kV AC (50 Hz, 60 s)
Insulation	Reinforced insulation according to IEC/EN 61010-1

Supply

Nominal supply voltage	24 V DC
Supply voltage range	9.6 V DC ... 30 V DC (The DIN rail connector (ME 6,2 TBUS-2 1,5/5-ST-3,81 GN, item no. 2869728) can be used to bridge the supply voltage. It can be snapped onto a 35 mm DIN rail in accordance with EN 60715)
Typical current consumption	25 mA (24 V DC)
	54 mA (12 V DC)
Power consumption	≤ 200 mW (at 9.6 V DC)

Input data

Signal: Current

Number of inputs	1
------------------	---

Signal conditioner - MINI MCR-2-I4-U-PT



2902003

<https://www.phoenixcontact.com/de/produkte/2902003>

Configurable/programmable	no
Current input signal	4 mA ... 20 mA
Input resistance current input	approx. 63 Ω (+0.7 V for test diode)

Output data

Signal: Voltage

Number of outputs	1
Configurable/programmable	no
Voltage output signal	0 V ... 10 V
Max. voltage output signal	11 V
Short-circuit current	< 15 mA
Load/output load voltage output	≥ 10 kΩ
Ripple	< 20 mV _{PP} (at 10 kΩ)

Connection data

Connection method	Push-in connection
Stripping length	10 mm
Conductor cross section solid	0.2 mm ² ... 2.5 mm ² (with ferrule) 0.14 mm ² ... 2.5 mm ² (without ferrule)
Conductor cross section flexible	0.14 mm ² ... 2.5 mm ²
Conductor cross section AWG	24 ... 12 (flexible)

LED signaling

Status display	Green LED (supply voltage)
----------------	----------------------------

Dimensions

Width	6.2 mm
Height	109.81 mm
Depth	119.2 mm

Material specifications

Fire protection for rail vehicles (DIN EN 45545-2) R22	HL 1 - HL 2
Fire protection for rail vehicles (DIN EN 45545-2) R23	HL 1 - HL 2
Fire protection for rail vehicles (DIN EN 45545-2) R24	HL 1 - HL 2
Housing material	PBT

Environmental and real-life conditions

Ambient conditions

Degree of protection	IP20 (not assessed by UL)
Ambient temperature (operation)	-40 °C ... 70 °C
Ambient temperature (storage/transport)	-40 °C ... 85 °C
Permissible humidity (operation)	5 % ... 95 % (non-condensing)

Approval data

Signal conditioner - MINI MCR-2-I4-U-PT



2902003

<https://www.phoenixcontact.com/de/produkte/2902003>

CE

Certificate	CE-compliant
-------------	--------------

ATEX

Identification	<input type="checkbox"/> II 3 G Ex ec IIC T4 Gc
Certificate	BVS 19 ATEX E 047 X

UKCA Ex (UKEX)

Identification	<input type="checkbox"/> II 3 G Ex ec IIC T4 Gc
Certificate	PxCIF21UKEX2902000X

IECEX

Identification	Ex ec IIC T4 Gc
Certificate	IECEX BVS 19.0041X

CCC / China-Ex

Identification	Ex nA IIC T4 Gc
----------------	-----------------

UL, USA / Canada

Identification	UL 508 Listed
	Class I, Div. 2, Groups A, B, C, D T6
	Class I, Zone 2, Group IIC T6

Shipbuilding approval

Certificate	DNV GL TAA00002UA
-------------	-------------------

EAC Ex

Identification	<input type="checkbox"/> 2Ex ec IIC T4 Gc
Certificate	BY/112 02.01 TP012 103.01 00079

DNV GL data

Temperature	B
Humidity	B
Vibration	A
EMC	A
Enclosure	Required protection according to the Rules shall be provided upon installation on board

EMC data

Electromagnetic compatibility	Conformance with EMC directive
Noise emission	EN 61000-6-4
Noise immunity	EN 61000-6-2
Note	When being exposed to interference, there may be minimal deviations.

Electrostatic discharge

Standards/regulations	EN 61000-4-2
-----------------------	--------------

Electrostatic discharge

Signal conditioner - MINI MCR-2-I4-U-PT



2902003

<https://www.phoenixcontact.com/de/produkte/2902003>

Comments	Safety measures must be taken to prevent electrostatic discharge.
----------	---

Electromagnetic HF field

Designation	Electromagnetic RF field
Standards/regulations	EN 61000-4-3

Fast transients (burst)

Designation	Fast transients (burst)
Standards/regulations	EN 61000-4-4

Surge current load (surge)

Standards/regulations	EN 61000-4-5
-----------------------	--------------

Conducted interference

Designation	Conducted interferences
Standards/regulations	EN 61000-4-6

Standards and regulations

Electrical isolation	3-way isolation
----------------------	-----------------

GB Standard

Standards/regulations	GB 3836.1
	GB 3836.8

Mounting

Mounting type	DIN rail mounting
Assembly instructions	The DIN rail connector can be used for bridging the supply voltage. It can be snapped onto a 35 mm EN 60715 DIN rail.
Mounting position	any

Signal conditioner - MINI MCR-2-I4-U-PT

2902003

<https://www.phoenixcontact.com/de/produkte/2902003>

Drawings

Block diagram

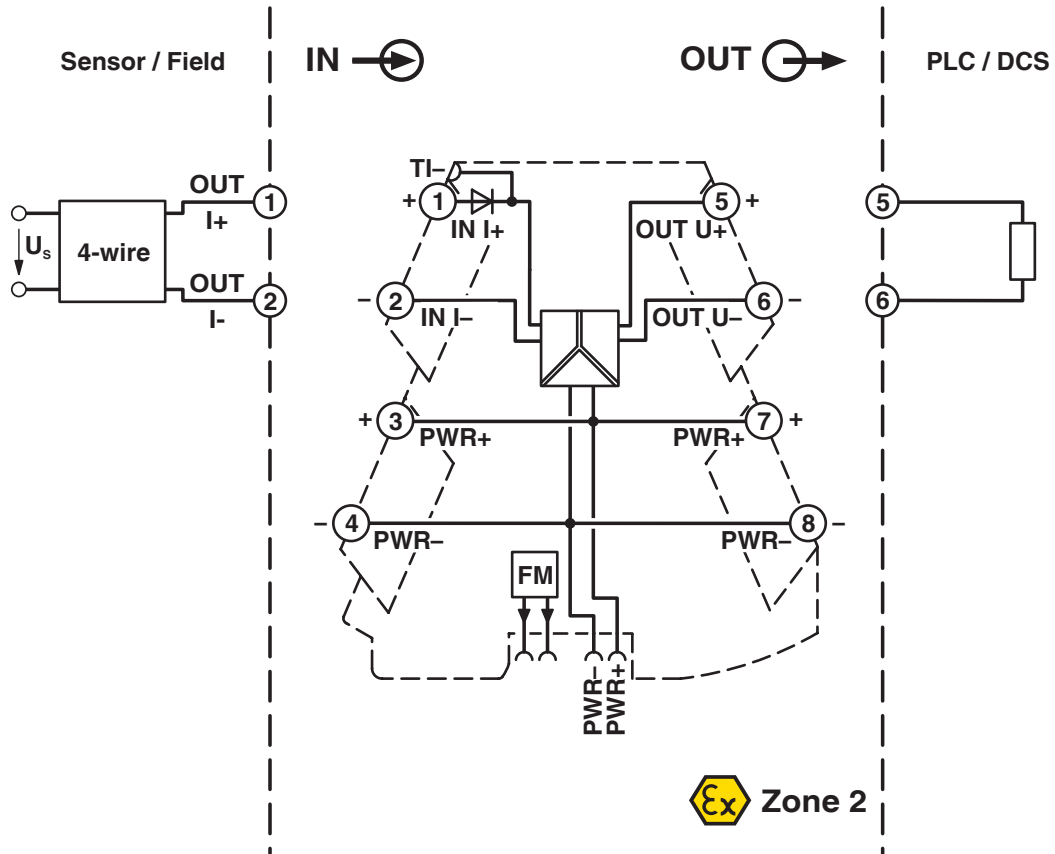

Signal conditioner - MINI MCR-2-I4-U-PT



2902003

<https://www.phoenixcontact.com/de/produkte/2902003>

Approvals



DNV GL

Approval ID: TAA00002UA



UL Listed

Approval ID: FILE E 238705

Nominal Voltage U_N

Nominal Current I_N

Cross Section AWG

Cross Section mm^2

-

-



CCC

Approval ID: 2021322310003859



cUL Listed

Approval ID: FILE E 238705

Nominal Voltage U_N

Nominal Current I_N

Cross Section AWG

Cross Section mm^2

-

-



EAC Ex

Approval ID: RU C-DE.AB72.B.02066



IECEX

Approval ID: IECEX BVS 19.0041X



cUL Listed

Approval ID: FILE E 196811

Nominal Voltage U_N

Nominal Current I_N

Cross Section AWG

Cross Section mm^2

-

-



UL Listed

Approval ID: FILE E 196811

Nominal Voltage U_N

Nominal Current I_N

Cross Section AWG

Cross Section mm^2

-

-



ATEX

Approval ID: BVS 19 ATEX E 047 X

Signal conditioner - MINI MCR-2-I4-U-PT



2902003

<https://www.phoenixcontact.com/de/produkte/2902003>



ATEX

Approval ID: 2902037_Ex-n

cULus Listed

cULus Listed

Signal conditioner - MINI MCR-2-I4-U-PT



2902003

<https://www.phoenixcontact.com/de/produkte/2902003>

Classifications

ECLASS

ECLASS-9.0	27210120
ECLASS-10.0.1	27210120
ECLASS-11.0	27210120

ETIM

ETIM 8.0	EC002653
----------	----------

UNSPSC

UNSPSC 21.0	39121000
-------------	----------

Signal conditioner - MINI MCR-2-I4-U-PT



2902003

<https://www.phoenixcontact.com/de/produkte/2902003>

Environmental Product Compliance

REACH SVHC	Lead 7439-92-1
China RoHS	Environmentally Friendly Use Period = 50 years
	For information on hazardous substances, refer to the manufacturer's declaration available under "Downloads"

Signal conditioner - MINI MCR-2-I4-U-PT

2902003

<https://www.phoenixcontact.com/de/produkte/2902003>

Accessories

Module carrier

Module carrier - TC-D37SUB-AIO16-MP-PS-UNI - 2906640

<https://www.phoenixcontact.com/de/produkte/2906640>

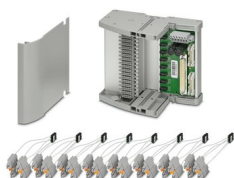

Universal Termination Carrier for connecting 16 MINI Analog Pro signal conditioners to digital or analog I/O cards, via D-SUB connector, 37-pos. (1:1 connection), with HART multiplexer connection

Module carrier

Module carrier - TC-D37SUB-ADIO16-MP-P-UNI - 2906639

<https://www.phoenixcontact.com/de/produkte/2906639>



Universal Termination Carrier for connecting 16 MINI Analog Pro signal conditioners to digital or analog I/O cards, via D-SUB connector, 37-pos. (1:1 connection)

Signal conditioner - MINI MCR-2-I4-U-PT

2902003

<https://www.phoenixcontact.com/de/produkte/2902003>



System adapter

System adapter - MINI MCR-2-V8-FLK 16 - 2901993

<https://www.phoenixcontact.com/de/produkte/2901993>



Eight MINI Analog Pro signal conditioners and measuring transducers can be connected to a controller with minimal cabling effort and without any errors using system adapters and system cabling.

DIN rail bus connectors

DIN rail bus connectors - ME 6,2 TBUS-2 1,5/5-ST-3,81 GY - 2695439

<https://www.phoenixcontact.com/de/produkte/2695439>



DIN rail connector (TBUS), 5-pos., for bridging the supply voltage, can be snapped onto NS 35/... DIN rail in accordance with EN 60715

Signal conditioner - MINI MCR-2-I4-U-PT

2902003

<https://www.phoenixcontact.com/de/produkte/2902003>



Power supply unit

Power supply unit - QUINT4-SYS-PS/1AC/24DC/2.5/SC - 2904614

<https://www.phoenixcontact.com/de/produkte/2904614>



Primary-switched power supply unit, QUINT POWER, Screw connection, DIN rail mounting, input: 1-phase, output: 24 V DC / 2.5 A

DIN rail bus connectors

DIN rail bus connectors - ME 6,2 TBUS-2 1,5/5-ST-3,81 GN - 2869728

<https://www.phoenixcontact.com/de/produkte/2869728>

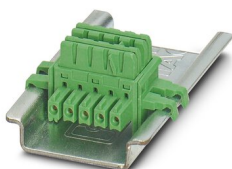

DIN rail connector for DIN rail mounting. Universal for TBUS housing. Gold-plated contacts, 5-pos.

Signal conditioner - MINI MCR-2-I4-U-PT

2902003

<https://www.phoenixcontact.com/de/produkte/2902003>

Power terminal block

Power terminal block - MINI MCR-2-PTB - 2902066

<https://www.phoenixcontact.com/de/produkte/2902066>



Power terminal with plug-in connection technology for delivering the supply voltage to the DIN rail connector. Monitoring of the supply voltages in combination with the fault monitoring module. Screw connection technology

Power terminal block

Power terminal block - MINI MCR-2-PTB-PT - 2902067

<https://www.phoenixcontact.com/de/produkte/2902067>



Power terminal with plug-in connection technology for delivering the supply voltage to the DIN rail connector. Monitoring of the supply voltages in combination with the fault monitoring module. Push-in connection technology

Signal conditioner - MINI MCR-2-I4-U-PT

2902003

<https://www.phoenixcontact.com/de/produkte/2902003>

Monitoring module

Monitoring module - MINI MCR-2-FM-RC - 2904504

<https://www.phoenixcontact.com/de/produkte/2904504>



Fault monitoring module with plug-in connection technology for evaluating and reporting group errors from the FM system and for monitoring the supply voltages. Error message via N/C contact. Screw connection technology, standard configuration

Monitoring module

Monitoring module - MINI MCR-2-FM-RC-PT - 2904508

<https://www.phoenixcontact.com/de/produkte/2904508>

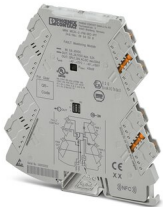

Fault monitoring module with plug-in connection technology for evaluating and reporting group errors from the FM system and for monitoring the supply voltages. Error message via N/C contact. Push-in connection technology, standard configuration

Signal conditioner - MINI MCR-2-I4-U-PT

2902003

<https://www.phoenixcontact.com/de/produkte/2902003>

Connector set

Connector set - FASTCON PRO-SET - 2906227

<https://www.phoenixcontact.com/de/produkte/2906227>



FASTCON Pro plug set consisting of four plugs with screw connection, one for each position on the module. Suitable for all MINI Analog Pro modules.

Connector set

Connector set - FASTCON PRO-SET-PT - 2906228

<https://www.phoenixcontact.com/de/produkte/2906228>



FASTCON Pro plug set consisting of four plugs with push-in connection, one for each position on the module. Suitable for all MINI Analog Pro modules.

Signal conditioner - MINI MCR-2-I4-U-PT

2902003

<https://www.phoenixcontact.com/de/produkte/2902003>

Marker for end clamp

Marker for end clamp - UCT-EM (30X5) - 0801505

<https://www.phoenixcontact.com/de/produkte/0801505>



Marker for end clamp, Sheet, white, unlabeled, can be labeled with: TOPMARK NEO, TOPMARK LASER, BLUEMARK ID COLOR, BLUEMARK ID, BLUEMARK CLED, THERMOMARK PRIME, THERMOMARK CARD 2.0, THERMOMARK CARD, mounting type: snapped, lettering field size: 30 x 5 mm, Number of individual labels: 24

Marker for end clamp

Marker for end clamp - UCT-EM (30X5) CUS - 0801589

<https://www.phoenixcontact.com/de/produkte/0801589>



Marker for end clamp, can be ordered: by sheet, white, labeled according to customer specifications, mounting type: snapped into marker carrier, lettering field size: 30 x 5 mm, Number of individual labels: 24

Signal conditioner - MINI MCR-2-I4-U-PT

2902003

<https://www.phoenixcontact.com/de/produkte/2902003>

Marker strip

Marker strip - SK 5,0 WH:REEL - 0805221

<https://www.phoenixcontact.com/de/produkte/0805221>



Marker strip, Roll, white, unlabeled, can be labeled with: THERMOMARK E.300 (D)/600 (D), THERMOMARK ROLL 2.0, THERMOMARK ROLL, THERMOMARK ROLL X1, THERMOMARK ROLLMASTER 300/600, THERMOMARK X1.2, mounting type: adhesive, for terminal block width: 5 mm, lettering field size: continuous x 5 mm, Number of individual labels: 90000

Plastic label

Plastic label - UC-EMLP (15X5) - 0819301

<https://www.phoenixcontact.com/de/produkte/0819301>



Plastic label, Sheet, white, unlabeled, can be labeled with: BLUEMARK ID COLOR, BLUEMARK ID, BLUEMARK CLED, PLOTMARK, CMS-P1-PLOTTER, mounting type: adhesive, lettering field size: 15 x 5 mm, Number of individual labels: 10

Signal conditioner - MINI MCR-2-I4-U-PT

2902003

<https://www.phoenixcontact.com/de/produkte/2902003>

Plastic label

Plastic label - UC-EMLP (15X5) YE - 0822615

<https://www.phoenixcontact.com/de/produkte/0822615>

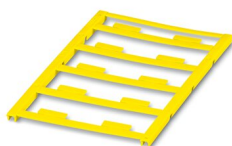

Plastic label, Sheet, yellow, unlabeled, can be labeled with: BLUEMARK ID COLOR, BLUEMARK ID, BLUEMARK CLED, PLOTMARK, CMS-P1-PLOTTER, mounting type: adhesive, lettering field size: 15 x 5 mm, Number of individual labels: 10

Plastic label

Plastic label - UC-EMLP (15X5) CUS - 0824550

<https://www.phoenixcontact.com/de/produkte/0824550>



Plastic label, can be ordered: by sheet, white, labeled according to customer specifications, mounting type: adhesive, lettering field size: 15 x 5 mm

2902003

<https://www.phoenixcontact.com/de/produkte/2902003>

Plastic label

Plastic label - UC-EMLP (15X5) YE CUS - 0824551

<https://www.phoenixcontact.com/de/produkte/0824551>

Plastic label, can be ordered: by sheet, yellow, labeled according to customer specifications, mounting type: adhesive, lettering field size: 15 x 5 mm

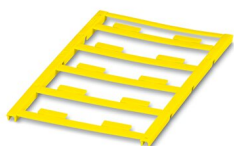

Plastic label

Plastic label - UC-EMLP (15X5) SR - 0828095

<https://www.phoenixcontact.com/de/produkte/0828095>

Plastic label, Sheet, silver, unlabeled, can be labeled with: BLUEMARK ID COLOR, BLUEMARK ID, BLUEMARK CLED, PLOTMARK, CMS-P1-PLOTTER, mounting type: adhesive, lettering field size: 15 x 5 mm, Number of individual labels: 10

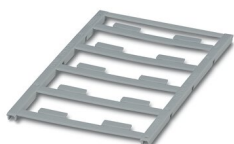

Signal conditioner - MINI MCR-2-I4-U-PT

2902003

<https://www.phoenixcontact.com/de/produkte/2902003>

Plastic label

Plastic label - UC-EMLP (15X5) SR CUS - 0828099

<https://www.phoenixcontact.com/de/produkte/0828099>



Plastic label, can be ordered: by sheet, silver, labeled according to customer specifications, mounting type: adhesive, lettering field size: 15 x 5 mm, Number of individual labels: 10

Plastic label

Plastic label - US-EMLP (15X5) - 0828790

<https://www.phoenixcontact.com/de/produkte/0828790>



Plastic label, Card, white, unlabeled, can be labeled with: BLUEMARK ID COLOR, BLUEMARK ID, THERMOMARK PRIME, THERMOMARK CARD 2.0, THERMOMARK CARD, mounting type: adhesive, lettering field size: 15 x 5 mm, Number of individual labels: 189

Signal conditioner - MINI MCR-2-I4-U-PT

2902003

<https://www.phoenixcontact.com/de/produkte/2902003>

Plastic label

Plastic label - US-EMLP (15X5) YE - 0828873

<https://www.phoenixcontact.com/de/produkte/0828873>



Plastic label, Card, yellow, unlabeled, can be labeled with: BLUEMARK ID COLOR, BLUEMARK ID, THERMOMARK PRIME, THERMOMARK CARD 2.0, THERMOMARK CARD, mounting type: adhesive, lettering field size: 15 x 5 mm, Number of individual labels: 189

Plastic label

Plastic label - US-EMLP (15X5) SR - 0828874

<https://www.phoenixcontact.com/de/produkte/0828874>



Plastic label, Card, silver, unlabeled, can be labeled with: BLUEMARK ID COLOR, BLUEMARK ID, THERMOMARK PRIME, THERMOMARK CARD 2.0, THERMOMARK CARD, mounting type: adhesive, lettering field size: 15 x 5 mm, Number of individual labels: 189

Signal conditioner - MINI MCR-2-I4-U-PT

2902003

<https://www.phoenixcontact.com/de/produkte/2902003>

Plastic label

Plastic label - US-EMLP (15X5) CUS - 0830076

<https://www.phoenixcontact.com/de/produkte/0830076>

Plastic label, can be ordered: by card, white, labeled according to customer specifications, mounting type: adhesive, lettering field size: 15 x 5 mm, Number of individual labels: 189



Plastic label

Plastic label - US-EMLP (15X5) YE CUS - 0830077

<https://www.phoenixcontact.com/de/produkte/0830077>

Plastic label, can be ordered: by card, yellow, labeled according to customer specifications, mounting type: adhesive, lettering field size: 15 x 5 mm, Number of individual labels: 189



Signal conditioner - MINI MCR-2-I4-U-PT

2902003

<https://www.phoenixcontact.com/de/produkte/2902003>

Plastic label

Plastic label - US-EMLP (15X5) SR CUS - 0830078

<https://www.phoenixcontact.com/de/produkte/0830078>

Plastic label, can be ordered: by card, silver, labeled according to customer specifications, mounting type: adhesive, lettering field size: 15 x 5 mm, Number of individual labels: 189



Marker for end clamp

Marker for end clamp - UCT-EM (30X5) YE - 0830340

<https://www.phoenixcontact.com/de/produkte/0830340>

Marker for end clamp, Sheet, yellow, unlabeled, can be labeled with: TOPMARK NEO, TOPMARK LASER, BLUEMARK ID COLOR, BLUEMARK ID, BLUEMARK CLED, THERMOMARK PRIME, THERMOMARK CARD 2.0, THERMOMARK CARD, mounting type: snapped, lettering field size: 30 x 5 mm, Number of individual labels: 24



Signal conditioner - MINI MCR-2-I4-U-PT

2902003

<https://www.phoenixcontact.com/de/produkte/2902003>



Marker for end clamp

Marker for end clamp - UCT-EM (30X5) YE CUS - 0830348

<https://www.phoenixcontact.com/de/produkte/0830348>

Marker for end clamp, can be ordered: by sheet, yellow, labeled according to customer specifications, mounting type: snapped into marker carrier, lettering field size: 30 x 5 mm, Number of individual labels: 24



Phoenix Contact 2022 © - all rights reserved

<https://www.phoenixcontact.com>

PHOENIX CONTACT Deutschland GmbH

Flachsmarktstraße 8

D-32825 Blomberg

+49 52 35/3-1 20 00

info@phoenixcontact.de