

PTPOWER 185-FE - High-current terminal block



1054724

<https://www.phoenixcontact.com/de/produkte/1054724>

Please be informed that the data shown in this PDF document is generated from our online catalog. Please find the complete data in the user documentation. Our general terms of use for downloads are valid.



High-current terminal block, nom. voltage: 1000 V, nominal current: 309 A, number of connections: 2, number of positions: 1, connection method: PowerTurn connection, 1 level, cross section: 95 mm² - 185 mm², mounting type: NS 35/15, color: black/yellow

Your advantages

- Quick and easy connection is now also possible for large conductors with the high-current terminal block
- In addition to using the existing test pick-off, pick-off terminal blocks can be connected, each of which can also accommodate two test cables
- The Push-in connection terminal blocks are characterized by the system features of the CLIPLINE complete system and by easy and tool-free wiring of conductors with ferrules or solid conductors
- The compact design enables wiring in a confined space

Commercial data

Item number	1054724
Packing unit	3 pc
Minimum order quantity	3 pc
Sales key	A1 - Reihenklemmen
Product key	BE2211
Catalog page	Page 141 (C-1-2019)
GTIN	4055626690834
Weight per piece (including packing)	350 g
Weight per piece (excluding packing)	350 g
Customs tariff number	85369010
Country of origin	PL

PTPOWER 185-FE - High-current terminal block



1054724

<https://www.phoenixcontact.com/de/produkte/1054724>

Technical data

Product properties

Product type	High current terminal block
Number of positions	1
Number of connections	2
Number of rows	1
Potentials	1

Insulation characteristics

Overvoltage category	III
Degree of pollution	3

Electrical properties

Rated surge voltage	8 kV
Maximum power dissipation for nominal condition	9.55 W

Connection data

Number of connections per level	2
Nominal cross section	150 mm ²

1 level

Stripping length	40 mm
Internal cylindrical gage	B14
Connection in acc. with standard	IEC 60947-7-1
Conductor cross section rigid	95 mm ² ... 185 mm ²
Cross section AWG	250 kcmil ... 350 kcmil (converted acc. to IEC)
Conductor cross section flexible	95 mm ² ... 185 mm ²
Conductor cross section, flexible [AWG]	250 kcmil ... 350 kcmil (converted acc. to IEC)
Conductor cross-section flexible (ferrule without plastic sleeve)	95 mm ² ... 150 mm ²
Flexible conductor cross section (ferrule with plastic sleeve)	95 mm ² ... 150 mm ²
Cross-section with insertion bridge, rigid	95 mm ² ... 150 mm ²
Cross-section with insertion bridge, flexible	95 mm ² ... 150 mm ²
Cross-section with insertion bridge, flexible, with ferrule without plastic sleeve	95 mm ² ... 120 mm ²
Cross-section with insertion bridge, flexible, with ferrule with plastic sleeve	95 mm ² ... 120 mm ²
Nominal current	309 A
Maximum load current	309 A (with 150 mm ² conductor cross section)
Nominal voltage	1000 V

1 level Connection cross sections directly pluggable

Conductor cross section rigid	95 mm ² ... 185 mm ²
Conductor cross-section flexible (ferrule without plastic sleeve)	95 mm ² ... 150 mm ²
Flexible conductor cross section (ferrule with plastic sleeve)	95 mm ² ... 150 mm ²

PTPOWER 185-FE - High-current terminal block



1054724

<https://www.phoenixcontact.com/de/produkte/1054724>

Dimensions

Width	31 mm
Height	116.4 mm
Depth on NS 35/15	116.5 mm

Material specifications

Color	black/yellow
Flammability rating according to UL 94	V0
Insulating material group	I
Insulating material	PA

Mechanical properties

Mechanical data

Open side panel	No
-----------------	----

Environmental and real-life conditions

Ambient conditions

Ambient temperature (operation)	-60 °C ... 110 °C (Operating temperature range incl. self-heating; for max. short-term operating temperature, see RTI Elec.)
Ambient temperature (storage/transport)	-25 °C ... 60 °C (for a short time, no longer than 24 h, -60°C to +70°C)
Ambient temperature (assembly)	-5 °C ... 70 °C
Ambient temperature (actuation)	-5 °C ... 70 °C
Permissible humidity (operation)	20 % ... 90 %
Permissible humidity (storage/transport)	30 % ... 70 %

Standards and regulations

Connection in acc. with standard	IEC 60947-7-1
----------------------------------	---------------

Mounting

Mounting type	NS 35/15
---------------	----------

PTPOWER 185-FE - High-current terminal block

1054724

<https://www.phoenixcontact.com/de/produkte/1054724>

Drawings

Schematic diagram

PTPOWER

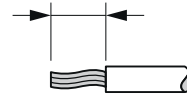
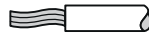

AGK 10-PTPOWER	0,5 mm ² ... 16 mm ²	18 mm
PTPOWER 35	2,5 mm ² ... 35 mm ²	25 mm
PTPOWER 50	10 mm ² ... 50 mm ²	32 mm
PTPOWER 95	25 mm ² ... 95 mm ²	40 mm
PTPOWER 185	95 mm ² ... 185 mm ²	40 mm

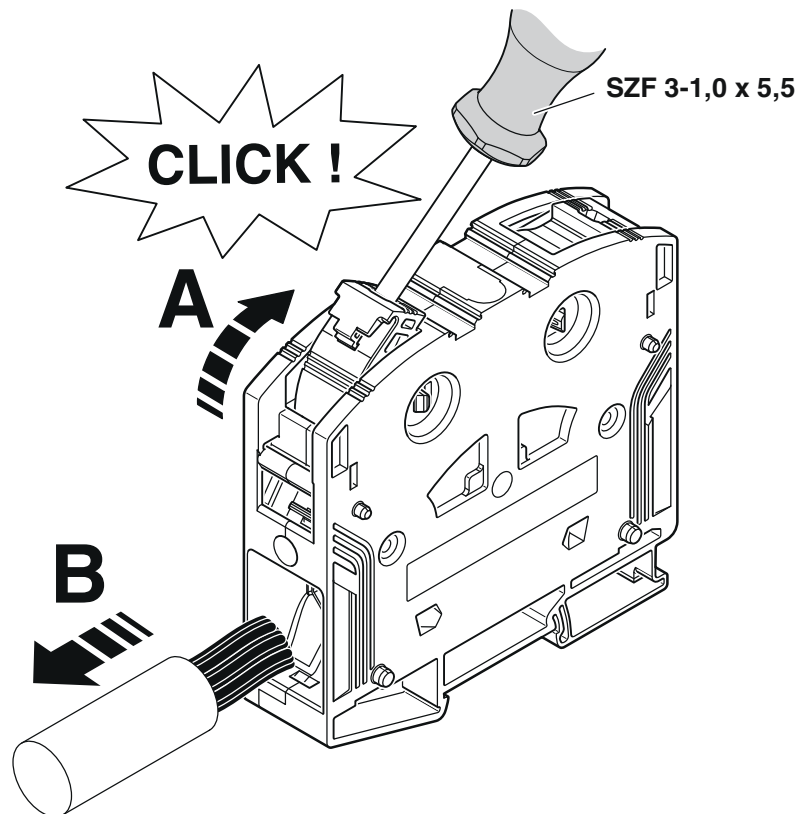

PPOWER 185-FE - High-current terminal block



1054724

<https://www.phoenixcontact.com/de/produkte/1054724>

Circuit diagram



PTPOWER 185-FE - High-current terminal block





1054724

<https://www.phoenixcontact.com/de/produkte/1054724>

Approvals

To download certificates, visit the product detail page: <https://www.phoenixcontact.com/de/produkte/1054724>

 UL Recognized Approval ID: E60425				
	Nominal voltage U_N	Nominal current I_N	Cross section AWG	Cross section mm^2
Use group F	1000 V	290 A	3/0 - 350	-
Use group E	1000 V	290 A	3/0 - 350	-

 EAC Approval ID: RU C-DE.BL08.B.00644				
---	--	--	--	--

 DNV Approval ID: TAE00000Z9				
---	--	--	--	--

PTPOWER 185-FE - High-current terminal block



1054724

<https://www.phoenixcontact.com/de/produkte/1054724>

Classifications

ECLASS

ECLASS-11.0	27141120
ECLASS-13.0	27250101

ETIM

ETIM 9.0	EC000897
----------	----------

UNSPSC

UNSPSC 21.0	39121400
-------------	----------

PTPOWER 185-FE - High-current terminal block



1054724

<https://www.phoenixcontact.com/de/produkte/1054724>

Environmental product compliance

EU RoHS

Fulfills EU RoHS substance requirements	Yes, No exemptions
---	--------------------

China RoHS

Environment friendly use period (EFUP)	EFUP-E
	No hazardous substances above the limits

EU REACH SVHC

REACH candidate substance (CAS No.)	No substance above 0.1 wt%
-------------------------------------	----------------------------

PTPOWER 185-FE - High-current terminal block

1054724

<https://www.phoenixcontact.com/de/produkte/1054724>

Accessories

i Note: Applying some accessories below might limit this product.

EB 2-31/PT - Insertion bridge

3215057

<https://www.phoenixcontact.com/de/produkte/3215057>

Insertion bridge, pitch: 31 mm, number of positions: 2, length: 78 mm, color: red



i Max. current carrying capacity: 232 A

EB 3-31/PT - Insertion bridge

3215058

<https://www.phoenixcontact.com/de/produkte/3215058>

Insertion bridge, pitch: 31 mm, number of positions: 3, length: 78 mm, color: red



i Max. current carrying capacity: 232 A

PTPOWER 185-FE - High-current terminal block

1054724

<https://www.phoenixcontact.com/de/produkte/1054724>

AGK 10-PTPOWER - Pick-off terminal block

3260145

<https://www.phoenixcontact.com/de/produkte/3260145>



Pick-off terminal block, nom. voltage: 1500 V, nominal current: 57 A, number of connections: 2, connection method: Push-in connection, 1 level, Rated cross section: 10 mm², cross section: 0.5 mm² - 16 mm², mounting type: on base element, color: gray

AGK 10-PTPOWER BU - Pick-off terminal block

3260148

<https://www.phoenixcontact.com/de/produkte/3260148>



Pick-off terminal block, nom. voltage: 1500 V, nominal current: 57 A, number of connections: 2, connection method: Push-in connection, 1 level, Rated cross section: 10 mm², cross section: 0.5 mm² - 16 mm², mounting type: on base element, color: blue

PTPOWER 185-FE - High-current terminal block

1054724

<https://www.phoenixcontact.com/de/produkte/1054724>

AGK 10-PTPOWER GN/YE - Pick-off terminal block

3260151

<https://www.phoenixcontact.com/de/produkte/3260151>



Pick-off terminal block, nom. voltage: 1500 V, nominal current: 57 A, number of connections: 2, connection method: Push-in connection, 1 level, Rated cross section: 10 mm², cross section: 0.5 mm² - 16 mm², mounting type: on base element, color: green/yellow

AGK 10-PTPOWER BK/YE - Pick-off terminal block

3260154

<https://www.phoenixcontact.com/de/produkte/3260154>



Pick-off terminal block, nom. voltage: 1500 V, nominal current: 57 A, number of connections: 2, connection method: Push-in connection, 1 level, Rated cross section: 10 mm², cross section: 0.5 mm² - 16 mm², mounting type: on base element, color: black/yellow

PTPOWER 185-FE - High-current terminal block

1054724

<https://www.phoenixcontact.com/de/produkte/1054724>

CEC PTPOWER 95/185 - Cover

1056087

<https://www.phoenixcontact.com/de/produkte/1056087>

Cover, yellow, labeled: Lightning flash, mounting type: plug in



NS 35/15 PERF 2000MM - DIN rail perforated

1201730

<https://www.phoenixcontact.com/de/produkte/1201730>



DIN rail perforated, Pack of 25 (50 m), similar to EN 60715, material: Steel, galvanized, passivated with a thick layer, Standard profile, color: silver

PTPOWER 185-FE - High-current terminal block

1054724

<https://www.phoenixcontact.com/de/produkte/1054724>

NS 35/15 UNPERF 2000MM - DIN rail, unperforated

1201714

<https://www.phoenixcontact.com/de/produkte/1201714>



DIN rail, unperforated, Pack of 25 (50 m), similar to EN 60715, material: Steel, galvanized, passivated with a thick layer, Standard profile, color: silver

NS 35/15 WH PERF 2000MM - DIN rail perforated

0806602

<https://www.phoenixcontact.com/de/produkte/0806602>



DIN rail perforated, Pack of 25 (50 m), similar to EN 60715, material: Steel, Galvanized, white passivated, Standard profile, color: white

PTPOWER 185-FE - High-current terminal block



1054724

<https://www.phoenixcontact.com/de/produkte/1054724>

NS 35/15 WH UNPERF 2000MM-VPE 10 - DIN rail, unperforated

1204135

<https://www.phoenixcontact.com/de/produkte/1204135>



DIN rail, unperforated, Pack of 10 (20 m), similar to EN 60715, material: Steel, Galvanized, white passivated, Standard profile, color: silver

NS 35/15 AL UNPERF 2000MM - DIN rail, unperforated

1201756

<https://www.phoenixcontact.com/de/produkte/1201756>



DIN rail, unperforated, similar to EN 60715, material: Aluminum, uncoated, Standard profile, color: silver

PTPOWER 185-FE - High-current terminal block

1054724

<https://www.phoenixcontact.com/de/produkte/1054724>

NS 35/15 ZN PERF 2000MM - DIN rail perforated

1206599

<https://www.phoenixcontact.com/de/produkte/1206599>



DIN rail perforated, Pack of 25 (50 m), similar to EN 60715, material: Steel, galvanized, Standard profile, color: silver

NS 35/15 ZN UNPERF 2000MM - DIN rail, unperforated

1206586

<https://www.phoenixcontact.com/de/produkte/1206586>



DIN rail, unperforated, Pack of 25 (50 m), similar to EN 60715, material: Steel, galvanized, Standard profile, color: silver

PTPOWER 185-FE - High-current terminal block



1054724

<https://www.phoenixcontact.com/de/produkte/1054724>

NS 35/15 CU UNPERF 2000MM-VPE 10 - DIN rail, unperforated

1201895

<https://www.phoenixcontact.com/de/produkte/1201895>



DIN rail, unperforated, Pack of 10 (20 m), similar to EN 60715, material: Copper, uncoated, Standard profile, color: copper-colored

NS 35/15 CAP - End cap

1206573

<https://www.phoenixcontact.com/de/produkte/1206573>

DIN rail end piece, for DIN rail NS 35/15



PTPOWER 185-FE - High-current terminal block



1054724

<https://www.phoenixcontact.com/de/produkte/1054724>

ZB 10:UNBEDRUCKT - Zack marker strip

1053001

<https://www.phoenixcontact.com/de/produkte/1053001>



Zack marker strip, Strip, white, unlabeled, can be labeled with: PLOTMARK, CMS-P1-PLOTTER, mounting type: snapped, for terminal block width: 10.2 mm, lettering field size: 10.5 x 10.15 mm, Number of individual labels: 10

ZB 10 CUS - Zack marker strip

0824941

<https://www.phoenixcontact.com/de/produkte/0824941>



Zack marker strip, can be ordered: Strip, white, labeled according to customer specifications, mounting type: snap into tall marker groove, for terminal block width: 10.2 mm, lettering field size: 10,15 x 10,5 mm, Number of individual labels: 10

PTPOWER 185-FE - High-current terminal block



1054724

<https://www.phoenixcontact.com/de/produkte/1054724>

ZB10,LGS:FORTL.ZAHLEN - Zack marker strip

1053014

<https://www.phoenixcontact.com/de/produkte/1053014>



Zack marker strip, Strip, white, labeled, can be labeled with: CMS-P1-PLOTTER, printed horizontally: consecutive numbers 1 ... 10, 11 ... 20, etc. up to 91 ... 100, mounting type: snapped, for terminal block width: 10.2 mm, lettering field size: 10,15 x 10,5 mm, Number of individual labels: 10

ZB10,QR:FORTL.ZAHLEN - Zack marker strip

1053027

<https://www.phoenixcontact.com/de/produkte/1053027>



Zack marker strip, Strip, white, labeled, can be labeled with: CMS-P1-PLOTTER, Printed vertically: consecutive numbers 1 ... 10, 11 ... 20, etc. up to 91 ... 100, mounting type: snapped, for terminal block width: 10.2 mm, lettering field size: 10,15 x 10,5 mm, Number of individual labels: 10

PTPOWER 185-FE - High-current terminal block



1054724

<https://www.phoenixcontact.com/de/produkte/1054724>

ZB10,LGS:L1-N,PE - Marker for terminal blocks

1053412

<https://www.phoenixcontact.com/de/produkte/1053412>



Marker for terminal blocks, Strip, white, labeled, can be labeled with: CMS-P1-PLOTTER, horizontal: L1, L2, L3, N, PE, L1, L2, L3, N, PE, mounting type: snapped, for terminal block width: 10.2 mm, lettering field size: 10,15 x 10,5 mm, Number of individual labels: 10

ZB10,LGS:U-N - Marker for terminal blocks

1053438

<https://www.phoenixcontact.com/de/produkte/1053438>



Marker for terminal blocks, Strip, white, labeled, can be labeled with: CMS-P1-PLOTTER, horizontal: U, V, W, N, GND, U, V, W, N, GND, mounting type: snapped, for terminal block width: 10.2 mm, lettering field size: 10,15 x 10,5 mm, Number of individual labels: 10

PTPOWER 185-FE - High-current terminal block



1054724

<https://www.phoenixcontact.com/de/produkte/1054724>

UC-TM 10 - Marker for terminal blocks

0818069

<https://www.phoenixcontact.com/de/produkte/0818069>



Marker for terminal blocks, Sheet, white, unlabeled, can be labeled with: BLUEMARK ID COLOR, BLUEMARK ID, BLUEMARK CLED, PLOTMARK, CMS-P1-PLOTTER, mounting type: snapped, for terminal block width: 10.2 mm, lettering field size: 9.6 x 10.5 mm, Number of individual labels: 48

UC-TM 10 CUS - Marker for terminal blocks

0824605

<https://www.phoenixcontact.com/de/produkte/0824605>



Marker for terminal blocks, can be ordered: by sheet, white, labeled according to customer specifications, mounting type: snap into tall marker groove, for terminal block width: 10.2 mm, lettering field size: 9.6 x 10.5 mm, Number of individual labels: 48

PTPOWER 185-FE - High-current terminal block



1054724

<https://www.phoenixcontact.com/de/produkte/1054724>

UCT-TM 10 - Marker for terminal blocks

0829142

<https://www.phoenixcontact.com/de/produkte/0829142>



Marker for terminal blocks, Sheet, white, unlabeled, can be labeled with: TOPMARK NEO, TOPMARK LASER, BLUEMARK ID COLOR, BLUEMARK ID, BLUEMARK CLED, THERMOMARK PRIME, THERMOMARK CARD 2.0, THERMOMARK CARD, mounting type: snapped, for terminal block width: 10.2 mm, lettering field size: 8.9 x 9.6 mm, Number of individual labels: 36

UCT-TM 10 CUS - Marker for terminal blocks

0829623

<https://www.phoenixcontact.com/de/produkte/0829623>



Marker for terminal blocks, can be ordered: by sheet, white, labeled according to customer specifications, mounting type: snap into tall marker groove, for terminal block width: 10.2 mm, lettering field size: 8.9 x 9.6 mm, Number of individual labels: 36

PTPOWER 185-FE - High-current terminal block



1054724

<https://www.phoenixcontact.com/de/produkte/1054724>

MPS-MT - Test plug

0201744

<https://www.phoenixcontact.com/de/produkte/0201744>



Test plug, with solder connection up to 1 mm² conductor cross section, number of positions: 1, color: gray

MPS-IH WH - Insulating sleeve

0201663

<https://www.phoenixcontact.com/de/produkte/0201663>

Insulating sleeve, color: white



PTPOWER 185-FE - High-current terminal block

1054724

<https://www.phoenixcontact.com/de/produkte/1054724>

MPS-IH RD - Insulating sleeve

0201676

<https://www.phoenixcontact.com/de/produkte/0201676>

Insulating sleeve, color: red



MPS-IH BU - Insulating sleeve

0201689

<https://www.phoenixcontact.com/de/produkte/0201689>

Insulating sleeve, color: blue

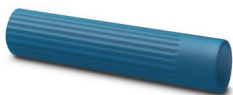

PTPOWER 185-FE - High-current terminal block

1054724

<https://www.phoenixcontact.com/de/produkte/1054724>

MPS-IH YE - Insulating sleeve

0201692

<https://www.phoenixcontact.com/de/produkte/0201692>

Insulating sleeve, color: yellow



MPS-IH GN - Insulating sleeve

0201702

<https://www.phoenixcontact.com/de/produkte/0201702>

Insulating sleeve, color: green



PTPOWER 185-FE - High-current terminal block

1054724

<https://www.phoenixcontact.com/de/produkte/1054724>



MPS-IH GY - Insulating sleeve

0201728

<https://www.phoenixcontact.com/de/produkte/0201728>

Insulating sleeve, color: gray



MPS-IH BK - Insulating sleeve

0201731

<https://www.phoenixcontact.com/de/produkte/0201731>

Insulating sleeve, color: black



PTPOWER 185-FE - High-current terminal block

1054724

<https://www.phoenixcontact.com/de/produkte/1054724>

SZF 3-1,0X5,5 - Screwdriver

1206612

<https://www.phoenixcontact.com/de/produkte/1206612>



Actuation tool, for ST terminal blocks, also suitable for use as a bladed screwdriver, size: 1.0 x 5.5 x 150 mm, 2-component grip, with non-slip grip

SZS 0,8X4,0 VDE - Screwdriver

1212508

<https://www.phoenixcontact.com/de/produkte/1212508>



Screwdriver, slot-headed, VDE insulated, size: 0.8 x 4.0 x 100 mm, 2-component grip, with non-slip grip

PTPOWER 185-FE - High-current terminal block

1054724

<https://www.phoenixcontact.com/de/produkte/1054724>

SZK PZ2 VDE - Screwdriver

1206463

<https://www.phoenixcontact.com/de/produkte/1206463>



Screwdriver, PZ crosshead, VDE insulated, size: PZ 2 x 100 mm, 2-component grip, with non-slip grip

SF-PH 2-100 S-VDE - Screwdriver

1212694

<https://www.phoenixcontact.com/de/produkte/1212694>



Screwdriver, crosshead PH (lasered), insulated, size: PH 2 x 100, 2-component handle, with non-slip grip

PTPOWER 185-FE - High-current terminal block



1054724

<https://www.phoenixcontact.com/de/produkte/1054724>

PROJECT COMPLETE - Software

1050453

<https://www.phoenixcontact.com/de/produkte/1050453>



Intuitive planning and marking software for configuring terminal strips and for professional marking of marking materials for terminal blocks, conductors, cables, devices, and systems. The software is available for download

A 95 -40 - Ferrule

3241242

<https://www.phoenixcontact.com/de/produkte/3241242>



Ferrule, color: silver

PTPOWER 185-FE - High-current terminal block

1054724

<https://www.phoenixcontact.com/de/produkte/1054724>

A 120 -40 - Ferrule

1090640

<https://www.phoenixcontact.com/de/produkte/1090640>



Ferrule, color: silver

CRIMPFOX 50R - Crimping pliers

1212041

<https://www.phoenixcontact.com/de/produkte/1212041>



Crimping pliers, for ferrules without insulating collar according to DIN 46228 Part 1 and ferrules with insulating collar according to DIN 46228 Part 4, 35 mm² ... 50 mm², lateral entry, WM crimp

PTPOWER 185-FE - High-current terminal block



1054724

<https://www.phoenixcontact.com/de/produkte/1054724>

CRIMPFOX-M - Crimping pliers

1212072

<https://www.phoenixcontact.com/de/produkte/1212072>



Basic pliers, for accommodating dies for a wide range of type of contacts

CRIMPFOX-C120 - Crimping pliers

1212318

<https://www.phoenixcontact.com/de/produkte/1212318>



Basic pliers, for accommodating dies for a wide range of type of contacts up to 120 mm²

Phoenix Contact 2024 © - all rights reserved
<https://www.phoenixcontact.com>

PHOENIX CONTACT Deutschland GmbH
Flachsmarktstraße 8
D-32825 Blomberg
+49 52 35/3-1 20 00
info@phoenixcontact.de