

PTPOWER 95-PE - Ground terminal



3260106

<https://www.phoenixcontact.com/de/produkte/3260106>

Please be informed that the data shown in this PDF document is generated from our online catalog. Please find the complete data in the user documentation. Our general terms of use for downloads are valid.



Ground terminal, number of connections: 2, number of positions: 1, connection method: PowerTurn connection, Rated cross section: 95 mm², cross section: 25 mm² - 95 mm², mounting type: 2.3 mm copper DIN rail, color: green-yellow

Your advantages

- Quick and easy connection is now also possible for large conductors with the high-current terminal block
- The compact design enables wiring in a confined space
- The Push-in connection terminal blocks are characterized by the system features of the CLIPLINE complete system and by easy and tool-free wiring of conductors with ferrules or solid conductors
- In addition to using the existing test pick-off, pick-off terminal blocks can be connected, each of which can also accommodate two test cables
- Tested for railway applications

Commercial data

Item number	3260106
Packing unit	3 pc
Minimum order quantity	3 pc
Sales key	A1 - Reihenklemmen
Product key	BE2221
Catalog page	Page 139 (C-1-2019)
GTIN	4046356778749
Weight per piece (including packing)	338,3 g
Weight per piece (excluding packing)	302 g
Customs tariff number	85369010
Country of origin	PL

3260106

<https://www.phoenixcontact.com/de/produkte/3260106>

Technical data

Product properties

Product type	Ground terminal block
Area of application	Railway industry
	Machine building
	Plant engineering
Number of positions	1
Number of connections	2
Number of rows	1

Insulation characteristics

Overvoltage category	III
Degree of pollution	3

Electrical properties

Rated surge voltage	8 kV
Maximum power dissipation for nominal condition	7.54 W

Connection data

Grounding foot	Yes
Number of connections per level	2
Nominal cross section	95 mm ²
Note	May only be mounted on 2.3 mm copper DIN rails
Stripping length	40 mm
Connection in acc. with standard	IEC 60947-7-2
Conductor cross section rigid	25 mm ² ... 95 mm ²
Cross section AWG	2 ... 3/0 (converted acc. to IEC)
Conductor cross section flexible	25 mm ² ... 95 mm ²
Conductor cross section, flexible [AWG]	2 ... 3/0 (converted acc. to IEC)
Conductor cross-section flexible (ferrule without plastic sleeve)	25 mm ² ... 95 mm ²
Flexible conductor cross section (ferrule with plastic sleeve)	25 mm ² ... 95 mm ²
Cross-section with insertion bridge, rigid	70 mm ²
Cross-section with insertion bridge, flexible	70 mm ²
Nominal cross section	95 mm ²

Connection cross sections directly pluggable

Conductor cross section rigid	25 mm ² ... 95 mm ²
Conductor cross-section flexible (ferrule without plastic sleeve)	25 mm ² ... 95 mm ²
Flexible conductor cross section (ferrule with plastic sleeve)	25 mm ² ... 95 mm ²

Ex data

Rated data (ATEX/IECEx)

Identification	Ⓔ II 2 GD Ex eb IIC Gb
----------------	------------------------

PTPOWER 95-PE - Ground terminal



3260106

<https://www.phoenixcontact.com/de/produkte/3260106>

Operating temperature range	-60 °C ... 110 °C
Ex-certified accessories	1206612 SZF 3-1,0X5,5
	1201662 E/AL-NS 35
output	(Permanent)

Ex connection data General

Ferrule length	40 mm
Stripping length	40 mm
Nominal cross section	95 mm ²
Rated cross section AWG	4/0
Connection capacity rigid	25 mm ² ... 95 mm ²
Connection capacity AWG	4 ... 4/0
Conductor cross section flexible, with ferrule without plastic sleeve min.	25 mm ²
Conductor cross section flexible, with ferrule without plastic sleeve max.	95 mm ²
Single conductor/terminal point, flexible, with ferrule, without plastic sleeve, AWG	4 ... 4/0

Dimensions

Width	25 mm
Height	105.5 mm
Depth on NS 35/15	108.7 mm

Material specifications

Color	green-yellow
Flammability rating according to UL 94	V0
Insulating material group	I
Insulating material	PA
Static insulating material application in cold	-60 °C
Temperature index of insulation material (DIN EN 60216-1 (VDE 0304-21))	125 °C
Relative insulation material temperature index (Elec., UL 746 B)	130 °C
Fire protection for rail vehicles (DIN EN 45545-2) R22	HL 1 - HL 3
Fire protection for rail vehicles (DIN EN 45545-2) R23	HL 1 - HL 3
Fire protection for rail vehicles (DIN EN 45545-2) R24	HL 1 - HL 3
Fire protection for rail vehicles (DIN EN 45545-2) R26	HL 1 - HL 3
Calorimetric heat release NFPA 130 (ASTM E 1354)	27,5 MJ/kg
Surface flammability NFPA 130 (ASTM E 162)	passed
Specific optical density of smoke NFPA 130 (ASTM E 662)	passed
Smoke gas toxicity NFPA 130 (SMP 800C)	passed

Mechanical properties

Mechanical data

Open side panel	No
-----------------	----

Environmental and real-life conditions

Oscillation/broadband noise

Specification	DIN EN 50155 (VDE 0115-200):2008-03
Spectrum	Service life test category 2, bogie-mounted
Frequency	$f_1 = 5 \text{ Hz}$ to $f_2 = 250 \text{ Hz}$
ASD level	6.12 (m/s ²)/Hz
Acceleration	3.12g
Test duration per axis	5 h
Test directions	X-, Y- and Z-axis
Result	Test passed

Shocks

Specification	DIN EN 50155 (VDE 0115-200):2008-03
Pulse shape	Half-sine
Acceleration	30g
Shock duration	18 ms
Number of shocks per direction	3
Test directions	X-, Y- and Z-axis (pos. and neg.)
Result	Test passed

Ambient conditions

Ambient temperature (operation)	-60 °C ... 110 °C (Operating temperature range incl. self-heating; for max. short-term operating temperature, see RTI Elec.)
Ambient temperature (storage/transport)	-25 °C ... 60 °C (for a short time, not exceeding 24 h, -60 °C to +70 °C)
Ambient temperature (assembly)	-5 °C ... 70 °C
Ambient temperature (actuation)	-5 °C ... 70 °C
Permissible humidity (operation)	20 % ... 90 %
Permissible humidity (storage/transport)	30 % ... 70 %

Standards and regulations

Connection in acc. with standard	IEC 60947-7-2
----------------------------------	---------------

Mounting

Mounting type	2.3 mm copper DIN rail
---------------	------------------------

PTPOWER 95-PE - Ground terminal

3260106

<https://www.phoenixcontact.com/de/produkte/3260106>

Drawings

Schematic diagram

PTPOWER

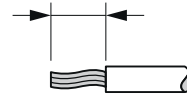
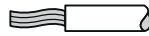

AGK 10-PTPOWER	0,5 mm ² ... 16 mm ²	18 mm
PTPOWER 35	2,5 mm ² ... 35 mm ²	25 mm
PTPOWER 50	10 mm ² ... 50 mm ²	32 mm
PTPOWER 95	25 mm ² ... 95 mm ²	40 mm
PTPOWER 185	95 mm ² ... 185 mm ²	40 mm

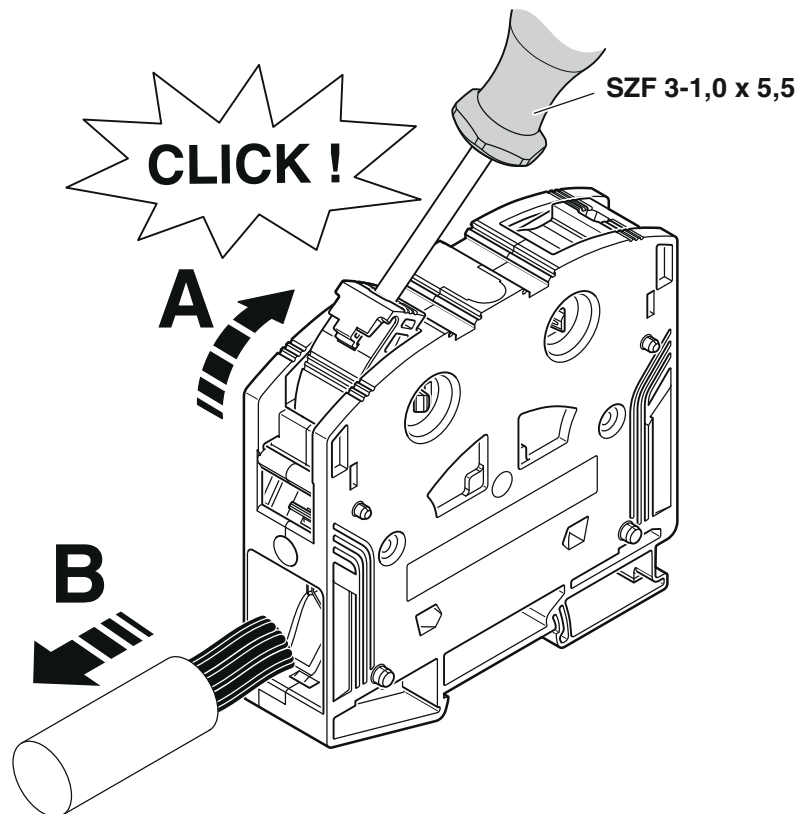

PTPOWER 95-PE - Ground terminal

3260106

<https://www.phoenixcontact.com/de/produkte/3260106>

Circuit diagram

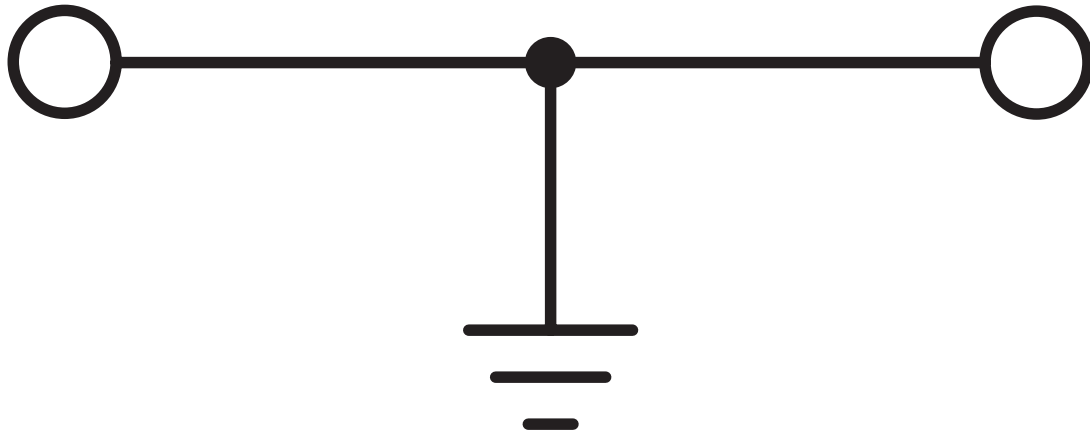

PTPOWER 95-PE - Ground terminal





3260106

<https://www.phoenixcontact.com/de/produkte/3260106>

Approvals

To download certificates, visit the product detail page: <https://www.phoenixcontact.com/de/produkte/3260106>

 **CSA**
Approval ID: 13631

 **EAC**
Approval ID: RU C-DE.BL08.B.00644

DNV
Approval ID: TAE0000029

 **cUL Recognized**
Approval ID: E60425

	Nominal voltage U_N	Nominal current I_N	Cross section AWG	Cross section mm^2
Use group C	-	-	4 - 4/0	-

 **UL Recognized**
Approval ID: E60425

	Nominal voltage U_N	Nominal current I_N	Cross section AWG	Cross section mm^2
Use group E	-	-	4 - 4/0	-

 **CSA**
Approval ID: 13631

 **EAC Ex**
Approval ID: RU C-DE.HA91.B.00066

 **CCC**
Approval ID: 2020322313000630

 **UKCA-EX**
Approval ID: CML 22UKEX1227U

 **IECEx**

PPOWER 95-PE - Ground terminal



3260106

<https://www.phoenixcontact.com/de/produkte/3260106>

Approval ID: IECExSEV14.0013U



ATEX

Approval ID: SEV14ATEX0156U

	Nominal voltage U_N	Nominal current I_N	Cross section AWG	Cross section mm^2
	-	-	-	25 - 95



IECEx

Approval ID: IECExSEV14.0013U

cULus Recognized

PTPOWER 95-PE - Ground terminal



3260106

<https://www.phoenixcontact.com/de/produkte/3260106>

Classifications

ECLASS

ECLASS-11.0	27141141
ECLASS-13.0	27250103

ETIM

ETIM 9.0	EC000901
----------	----------

UNSPSC

UNSPSC 21.0	39121400
-------------	----------

PTPOWER 95-PE - Ground terminal



3260106

<https://www.phoenixcontact.com/de/produkte/3260106>

Environmental product compliance

EU RoHS

Fulfills EU RoHS substance requirements	Yes, No exemptions
---	--------------------

China RoHS

Environment friendly use period (EFUP)	EFUP-E
	No hazardous substances above the limits

EU REACH SVHC

REACH candidate substance (CAS No.)	No substance above 0.1 wt%
-------------------------------------	----------------------------

PTPOWER 95-PE - Ground terminal

3260106

<https://www.phoenixcontact.com/de/produkte/3260106>

Accessories

 Note: Applying some accessories below might limit this product.

EB 2-25/PT - Insertion bridge

3260157

<https://www.phoenixcontact.com/de/produkte/3260157>

Insertion bridge, pitch: 25 mm, number of positions: 2, length: 73 mm, color: red



 Max. current carrying capacity: 150 A

EB 3-25/PT - Insertion bridge

3260160

<https://www.phoenixcontact.com/de/produkte/3260160>

Insertion bridge, pitch: 25 mm, number of positions: 3, length: 73 mm, color: red



 Max. current carrying capacity: 150 A

PTPOWER 95-PE - Ground terminal

3260106

<https://www.phoenixcontact.com/de/produkte/3260106>



AGK 10-PTPOWER - Pick-off terminal block

3260145

<https://www.phoenixcontact.com/de/produkte/3260145>



Pick-off terminal block, nom. voltage: 1500 V, nominal current: 57 A, number of connections: 2, connection method: Push-in connection, 1 level, Rated cross section: 10 mm², cross section: 0.5 mm² - 16 mm², mounting type: on base element, color: gray

AGK 10-PTPOWER BU - Pick-off terminal block

3260148

<https://www.phoenixcontact.com/de/produkte/3260148>



Pick-off terminal block, nom. voltage: 1500 V, nominal current: 57 A, number of connections: 2, connection method: Push-in connection, 1 level, Rated cross section: 10 mm², cross section: 0.5 mm² - 16 mm², mounting type: on base element, color: blue

PTPOWER 95-PE - Ground terminal

3260106

<https://www.phoenixcontact.com/de/produkte/3260106>



AGK 10-PTPOWER GN/YE - Pick-off terminal block

3260151

<https://www.phoenixcontact.com/de/produkte/3260151>

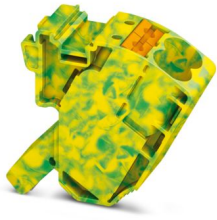

Pick-off terminal block, nom. voltage: 1500 V, nominal current: 57 A, number of connections: 2, connection method: Push-in connection, 1 level, Rated cross section: 10 mm², cross section: 0.5 mm² - 16 mm², mounting type: on base element, color: green/yellow

AGK 10-PTPOWER BK/YE - Pick-off terminal block

3260154

<https://www.phoenixcontact.com/de/produkte/3260154>



Pick-off terminal block, nom. voltage: 1500 V, nominal current: 57 A, number of connections: 2, connection method: Push-in connection, 1 level, Rated cross section: 10 mm², cross section: 0.5 mm² - 16 mm², mounting type: on base element, color: black/yellow

PTPOWER 95-PE - Ground terminal

3260106

<https://www.phoenixcontact.com/de/produkte/3260106>



CEC PTPOWER 95/185 - Cover

1056087

<https://www.phoenixcontact.com/de/produkte/1056087>



Cover, yellow, labeled: Lightning flash, mounting type: plug in

ZB 10:UNBEDRUCKT - Zack marker strip

1053001

<https://www.phoenixcontact.com/de/produkte/1053001>



Zack marker strip, Strip, white, unlabeled, can be labeled with: PLOTMARK, CMS-P1-PLOTTER, mounting type: snapped, for terminal block width: 10.2 mm, lettering field size: 10.5 x 10.15 mm, Number of individual labels: 10

PTPOWER 95-PE - Ground terminal

3260106

<https://www.phoenixcontact.com/de/produkte/3260106>



ZB 10 CUS - Zack marker strip

0824941

<https://www.phoenixcontact.com/de/produkte/0824941>



Zack marker strip, can be ordered: Strip, white, labeled according to customer specifications, mounting type: snap into tall marker groove, for terminal block width: 10.2 mm, lettering field size: 10,15 x 10,5 mm, Number of individual labels: 10

ZB10,LGS:FORTL.ZAHLEN - Zack marker strip

1053014

<https://www.phoenixcontact.com/de/produkte/1053014>



Zack marker strip, Strip, white, labeled, can be labeled with: CMS-P1-PLOTTER, printed horizontally: consecutive numbers 1 ... 10, 11 ... 20, etc. up to 91 ... 100, mounting type: snapped, for terminal block width: 10.2 mm, lettering field size: 10,15 x 10,5 mm, Number of individual labels: 10

PTPOWER 95-PE - Ground terminal

3260106

<https://www.phoenixcontact.com/de/produkte/3260106>

ZB10,QR:FORTL.ZAHLEN - Zack marker strip

1053027

<https://www.phoenixcontact.com/de/produkte/1053027>



Zack marker strip, Strip, white, labeled, can be labeled with: CMS-P1-PLOTTER, Printed vertically: consecutive numbers 1 ... 10, 11 ... 20, etc. up to 91 ... 100, mounting type: snapped, for terminal block width: 10.2 mm, lettering field size: 10,15 x 10,5 mm, Number of individual labels: 10

ZB10,LGS:L1-N,PE - Marker for terminal blocks

1053412

<https://www.phoenixcontact.com/de/produkte/1053412>



Marker for terminal blocks, Strip, white, labeled, can be labeled with: CMS-P1-PLOTTER, horizontal: L1, L2, L3, N, PE, L1, L2, L3, N, PE, mounting type: snapped, for terminal block width: 10.2 mm, lettering field size: 10,15 x 10,5 mm, Number of individual labels: 10

PTPOWER 95-PE - Ground terminal

3260106

<https://www.phoenixcontact.com/de/produkte/3260106>



ZB10,LGS:U-N - Marker for terminal blocks

1053438

<https://www.phoenixcontact.com/de/produkte/1053438>



Marker for terminal blocks, Strip, white, labeled, can be labeled with: CMS-P1-PLOTTER, horizontal: U, V, W, N, GND, U, V, W, N, GND, mounting type: snapped, for terminal block width: 10.2 mm, lettering field size: 10,15 x 10,5 mm, Number of individual labels: 10

UC-TM 10 - Marker for terminal blocks

0818069

<https://www.phoenixcontact.com/de/produkte/0818069>



Marker for terminal blocks, Sheet, white, unlabeled, can be labeled with: BLUEMARK ID COLOR, BLUEMARK ID, BLUEMARK CLED, PLOTMARK, CMS-P1-PLOTTER, mounting type: snapped, for terminal block width: 10.2 mm, lettering field size: 9.6 x 10.5 mm, Number of individual labels: 48

PTPOWER 95-PE - Ground terminal

3260106

<https://www.phoenixcontact.com/de/produkte/3260106>



UC-TM 10 CUS - Marker for terminal blocks

0824605

<https://www.phoenixcontact.com/de/produkte/0824605>



Marker for terminal blocks, can be ordered: by sheet, white, labeled according to customer specifications, mounting type: snap into tall marker groove, for terminal block width: 10.2 mm, lettering field size: 9.6 x 10.5 mm, Number of individual labels: 48

UCT-TM 10 - Marker for terminal blocks

0829142

<https://www.phoenixcontact.com/de/produkte/0829142>



Marker for terminal blocks, Sheet, white, unlabeled, can be labeled with: TOPMARK NEO, TOPMARK LASER, BLUEMARK ID COLOR, BLUEMARK ID, BLUEMARK CLED, THERMOMARK PRIME, THERMOMARK CARD 2.0, THERMOMARK CARD, mounting type: snapped, for terminal block width: 10.2 mm, lettering field size: 8.9 x 9.6 mm, Number of individual labels: 36

PTPOWER 95-PE - Ground terminal

3260106

<https://www.phoenixcontact.com/de/produkte/3260106>



UCT-TM 10 CUS - Marker for terminal blocks

0829623

<https://www.phoenixcontact.com/de/produkte/0829623>



Marker for terminal blocks, can be ordered: by sheet, white, labeled according to customer specifications, mounting type: snap into tall marker groove, for terminal block width: 10.2 mm, lettering field size: 8.9 x 9.6 mm, Number of individual labels: 36

ZBF10:UNBEDRUCKT - Zack Marker strip, flat

0809997

<https://www.phoenixcontact.com/de/produkte/0809997>



Zack Marker strip, flat, Strip, white, unlabeled, can be labeled with: CMS-P1-PLOTTER, PLOTMARK, mounting type: snapped, for terminal block width: 10 mm, lettering field size: 5.15 x 10 mm, Number of individual labels: 10

PTPOWER 95-PE - Ground terminal

3260106

<https://www.phoenixcontact.com/de/produkte/3260106>

ZBF10 CUS - Zack Marker strip, flat

0825031

<https://www.phoenixcontact.com/de/produkte/0825031>



Zack Marker strip, flat, can be ordered: Strip, white, labeled according to customer specifications, mounting type: snap into flat marker groove, for terminal block width: 10 mm, lettering field size: 5.15 x 10 mm, Number of individual labels: 10

ZBF10,LGS:FORTL.ZAHLEN - Zack Marker strip, flat

0810009

<https://www.phoenixcontact.com/de/produkte/0810009>



Zack Marker strip, flat, Strip, white, labeled, printed horizontally: consecutive numbers 1 ... 10, 11 ... 20, etc. up to 91 ... 100, mounting type: snapped, for terminal block width: 10 mm, lettering field size: 5.15 x 10 mm, Number of individual labels: 10

PTPOWER 95-PE - Ground terminal

3260106

<https://www.phoenixcontact.com/de/produkte/3260106>

ZBF10,QR:FORTL.ZAHLEN - Zack Marker strip, flat

0810025

<https://www.phoenixcontact.com/de/produkte/0810025>



Zack Marker strip, flat, Strip, white, labeled, Printed vertically: consecutive numbers 1 ... 10, 11 ... 20, etc. up to 91 ... 100, mounting type: snapped, for terminal block width: 10 mm, lettering field size: 5.15 x 10 mm, Number of individual labels: 10

UC-TMF 10 - Marker for terminal blocks

0818124

<https://www.phoenixcontact.com/de/produkte/0818124>



Marker for terminal blocks, Sheet, white, unlabeled, can be labeled with: BLUEMARK ID COLOR, BLUEMARK ID, BLUEMARK CLED, PLOTMARK, CMS-P1-PLOTTER, mounting type: snapped, for terminal block width: 10.2 mm, lettering field size: 9.6 x 5.1 mm, Number of individual labels: 48

PTPOWER 95-PE - Ground terminal

3260106

<https://www.phoenixcontact.com/de/produkte/3260106>

UC-TMF 10 CUS - Marker for terminal blocks

0824662

<https://www.phoenixcontact.com/de/produkte/0824662>



Marker for terminal blocks, can be ordered: by sheet, white, labeled according to customer specifications, mounting type: snap into flat marker groove, for terminal block width: 10.2 mm, lettering field size: 9.6 x 5.1 mm, Number of individual labels: 48

UCT-TMF 10 - Marker for terminal blocks

0829204

<https://www.phoenixcontact.com/de/produkte/0829204>



Marker for terminal blocks, Sheet, white, unlabeled, can be labeled with: TOPMARK NEO, TOPMARK LASER, BLUEMARK ID COLOR, BLUEMARK ID, BLUEMARK CLED, THERMOMARK PRIME, THERMOMARK CARD 2.0, THERMOMARK CARD, mounting type: snapped, for terminal block width: 10.2 mm, lettering field size: 9.4 x 4.7 mm, Number of individual labels: 36

PTPOWER 95-PE - Ground terminal

3260106

<https://www.phoenixcontact.com/de/produkte/3260106>



UCT-TMF 10 CUS - Marker for terminal blocks

0829679

<https://www.phoenixcontact.com/de/produkte/0829679>



Marker for terminal blocks, can be ordered: by sheet, white, labeled according to customer specifications, mounting type: snap into flat marker groove, for terminal block width: 10.2 mm, lettering field size: 9.4 x 4.7 mm, Number of individual labels: 36

MPS-MT - Test plug

0201744

<https://www.phoenixcontact.com/de/produkte/0201744>



Test plug, with solder connection up to 1 mm² conductor cross section, number of positions: 1, color: gray

PTPOWER 95-PE - Ground terminal

3260106

<https://www.phoenixcontact.com/de/produkte/3260106>



MPS-IH WH - Insulating sleeve

0201663

<https://www.phoenixcontact.com/de/produkte/0201663>

Insulating sleeve, color: white



MPS-IH RD - Insulating sleeve

0201676

<https://www.phoenixcontact.com/de/produkte/0201676>

Insulating sleeve, color: red



PTPOWER 95-PE - Ground terminal

3260106

<https://www.phoenixcontact.com/de/produkte/3260106>



MPS-IH BU - Insulating sleeve

0201689

<https://www.phoenixcontact.com/de/produkte/0201689>

Insulating sleeve, color: blue

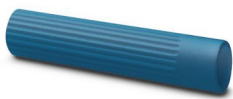

MPS-IH YE - Insulating sleeve

0201692

<https://www.phoenixcontact.com/de/produkte/0201692>

Insulating sleeve, color: yellow



PTPOWER 95-PE - Ground terminal

3260106

<https://www.phoenixcontact.com/de/produkte/3260106>



MPS-IH GN - Insulating sleeve

0201702

<https://www.phoenixcontact.com/de/produkte/0201702>

Insulating sleeve, color: green



MPS-IH GY - Insulating sleeve

0201728

<https://www.phoenixcontact.com/de/produkte/0201728>

Insulating sleeve, color: gray



PTPOWER 95-PE - Ground terminal

3260106

<https://www.phoenixcontact.com/de/produkte/3260106>



MPS-IH BK - Insulating sleeve

0201731

<https://www.phoenixcontact.com/de/produkte/0201731>

Insulating sleeve, color: black



SZF 3-1,0X5,5 - Screwdriver

1206612

<https://www.phoenixcontact.com/de/produkte/1206612>

Actuation tool, for ST terminal blocks, also suitable for use as a bladed screwdriver, size: 1.0 x 5.5 x 150 mm, 2-component grip, with non-slip grip



PTPOWER 95-PE - Ground terminal

3260106

<https://www.phoenixcontact.com/de/produkte/3260106>



SZS 0,8X4,0 VDE - Screwdriver

1212508

<https://www.phoenixcontact.com/de/produkte/1212508>



Screwdriver, slot-headed, VDE insulated, size: 0.8 x 4.0 x 100 mm, 2-component grip, with non-slip grip

SF-PHSL 2-100 VDE - Screwdriver

1212288

<https://www.phoenixcontact.com/de/produkte/1212288>



Screwdriver, positive/negative PH slot, VDE insulated, size: PH 2 x 100, 2-component grip, with non-slip grip

PTPOWER 95-PE - Ground terminal

3260106

<https://www.phoenixcontact.com/de/produkte/3260106>



PROJECT COMPLETE - Software

1050453

<https://www.phoenixcontact.com/de/produkte/1050453>



Intuitive planning and marking software for configuring terminal strips and for professional marking of marking materials for terminal blocks, conductors, cables, devices, and systems. The software is available for download

CRIMPFOX 25R - Crimping pliers

1212039

<https://www.phoenixcontact.com/de/produkte/1212039>



Crimping pliers, for ferrules without insulating collar according to DIN 46228 Part 1 and ferrules with insulating collar according to DIN 46228 Part 4, 10 mm² ... 25 mm², lateral entry, WM crimp

PTPOWER 95-PE - Ground terminal

3260106

<https://www.phoenixcontact.com/de/produkte/3260106>

CRIMPFOX 50R - Crimping pliers

1212041

<https://www.phoenixcontact.com/de/produkte/1212041>



Crimping pliers, for ferrules without insulating collar according to DIN 46228 Part 1 and ferrules with insulating collar according to DIN 46228 Part 4, 35 mm² ... 50 mm², lateral entry, WM crimp

CRIMPFOX-M - Crimping pliers

1212072

<https://www.phoenixcontact.com/de/produkte/1212072>



Basic pliers, for accommodating dies for a wide range of type of contacts

PTPOWER 95-PE - Ground terminal

3260106

<https://www.phoenixcontact.com/de/produkte/3260106>



CRIMPFOX-C120 - Crimping pliers

1212318

<https://www.phoenixcontact.com/de/produkte/1212318>



Basic pliers, for accommodating dies for a wide range of type of contacts up to 120 mm²

Phoenix Contact 2024 © - all rights reserved

<https://www.phoenixcontact.com>

PHOENIX CONTACT Deutschland GmbH

Flachsmarktstraße 8

D-32825 Blomberg

+49 52 35/3-1 20 00

info@phoenixcontact.de