

## UMSTBVK 2,5/16-G-5,08

Order No.: 1788253

The figure shows a 10-position version of the product

<http://catalog.phoenixcontact.net/phoenix/treeViewClick.do?UID=1788253>

Plug component, Nominal current: 12 A, Rated voltage (III/2): 320 V,  
Number of positions: 16, Pitch: 5.08 mm, Connection method: Screw  
connection, Color: green, Contact surface: Tin, Assembly: DIN rail

### Commercial data

EAN	 4 017918 043315
Pack	50 Pcs.
Customs tariff	85366990
Product key	105121
Catalog page information	Page 333 (CC-2011)

### Product notes

WEEE/RoHS-compliant since:  
01/01/2003



<http://www.download.phoenixcontact.com>  
Please note that the data given here has been taken from the online catalog. For comprehensive information and data, please refer to the user documentation. The General Terms and Conditions of Use apply to Internet downloads.

### Technical data

#### Dimensions / positions

Width	42.5 mm
Pitch	5.08 mm
Dimension a	76.2 mm
Number of positions	16

Screw thread	M3
Tightening torque, min	0.5 Nm
Tightening torque max	0.6 Nm

**Technical data**

Range of articles	UMSTBVK 2,5/...-G
Insulating material group	I
Rated surge voltage (III/3)	4 kV
Rated surge voltage (III/2)	4 kV
Rated surge voltage (II/2)	4 kV
Rated voltage (III/2)	320 V
Rated voltage (II/2)	630 V
Connection in acc. with standard	EN-VDE
Nominal current $I_N$	12 A
Nominal voltage $U_N$	320 V
Nominal cross section	2.5 mm <sup>2</sup>
Insulating material	PA
Inflammability class according to UL 94	V2
Internal cylindrical gage	A3
Stripping length	7 mm

**Connection data**

Conductor cross section solid min.	0.2 mm <sup>2</sup>
Conductor cross section solid max.	2.5 mm <sup>2</sup>
Conductor cross section stranded min.	0.2 mm <sup>2</sup>
Conductor cross section stranded max.	2.5 mm <sup>2</sup>
Conductor cross section stranded, with ferrule without plastic sleeve min.	0.25 mm <sup>2</sup>
Conductor cross section stranded, with ferrule without plastic sleeve max.	2.5 mm <sup>2</sup>
Conductor cross section stranded, with ferrule with plastic sleeve min.	0.25 mm <sup>2</sup>
Conductor cross section stranded, with ferrule with plastic sleeve max.	2.5 mm <sup>2</sup>
2 conductors with same cross section, solid min.	0.2 mm <sup>2</sup>
2 conductors with same cross section, solid max.	1 mm <sup>2</sup>
2 conductors with same cross section, stranded min.	0.2 mm <sup>2</sup>

2 conductors with same cross section, stranded max.	1.5 mm <sup>2</sup>
2 conductors with same cross section, stranded, ferrules without plastic sleeve, min.	0.25 mm <sup>2</sup>
2 conductors with same cross section, stranded, ferrules without plastic sleeve, max.	1 mm <sup>2</sup>
2 conductors with same cross section, stranded, TWIN ferrules with plastic sleeve, min.	0.5 mm <sup>2</sup>
2 conductors with same cross section, stranded, TWIN ferrules with plastic sleeve, max.	1.5 mm <sup>2</sup>
Conductor cross section AWG/kcmil min.	24
Conductor cross section AWG/kcmil max	12

### Certificates / Approvals

Certification CB, CSA, CUL, GOST, UL, VDE-PZI

### Accessories

Item	Designation	Description
<b>Assembly</b>		
1755477	MSTB-BL	Keying cap, for forming sections, plugs onto header pin, green insulating material
<b>General</b>		
1733169	EBP 2- 5	Insertion bridge, fully insulated, for plug connectors with 5.0 or 5.08 mm pitch, no. of positions: 2
<b>Marking</b>		
0804293	SK 5,08/3,8:FORTL.ZAHLEN	Marker cards, Card, white, Labeled, Horizontal: Consecutive numbers 1 - 10, 11 - 20, etc. up to 91 - (99)100, Mounting type: Adhesive, For terminal block width: 5.08 mm
<b>Plug/Adapter</b>		
1734401	CR-MSTB	Coding section, inserted into the recess in the header or the inverted plug, red insulating material
<b>Tools</b>		
1205053	SZS 0,6X3,5	Actuation tool, for ST terminal blocks, insulated, also suitable for use as a bladed screwdriver, size: 0.6 x 3.5 x 100 mm, 2-component grip, with non-slip grip

### Additional products

Item	Designation	Description
<b>General</b>		
1873197	FKC 2,5/16-ST-5,08	Plug component, Nominal current: 12 A, Rated voltage (III/2): 320 V, Number of positions: 16, Pitch: 5.08 mm, Connection method: Spring-cage conn., Color: green, Contact surface: Tin
1874099	FKCVR 2,5/16-ST-5,08	Plug component, Nominal current: 12 A, Rated voltage (III/2): 320 V, Number of positions: 16, Pitch: 5.08 mm, Connection method: Spring-cage conn., Color: green, Contact surface: Tin
1777426	FRONT-MSTB 2,5/16-ST-5,08	Plug component, Nominal current: 12 A, Rated voltage (III/2): 320 V, Number of positions: 16, Pitch: 5.08 mm, Connection method: Screw connection, Color: green, Contact surface: Tin
1757158	MSTB 2,5/16-ST-5,08	Plug component, Nominal current: 12 A, Rated voltage (III/2): 320 V, Number of positions: 16, Pitch: 5.08 mm, Connection method: Screw connection, Color: green, Contact surface: Tin
1764248	MSTB 2,5/16-STZ-5,08	Plug component, Nominal current: 12 A, Rated voltage (III/2): 320 V, Number of positions: 16, Pitch: 5.08 mm, Connection method: Screw connection, Color: green, Contact surface: Tin
1808955	MSTBC 2,5/16-ST-5,08	Plug component, Nominal current: 12 A, Rated voltage (III/2): 320 V, Number of positions: 16, Pitch: 5.08 mm, Connection method: Crimp connection, Color: green, Corresponding female crimp contacts with current [A] and conductor cross section range [mm <sup>2</sup> ] data: 10A/MSTBC-MT 0,5-1,0 (3190564); 10A/MSTBC-MT 0,5-1,0 BA (3190645); 12A/MSTBC-MT 1,5-2,5 (3190551); 12A/MSTBC-MT 1,5-2,5 BA (3190658). BA = Bandkontakte
1809640	MSTBC 2,5/16-STZ-5,08	Plug component, Nominal current: 12 A, Rated voltage (III/2): 320 V, Number of positions: 16, Pitch: 5.08 mm, Connection method: Crimp connection, Color: green, Corresponding female crimp contacts with current [A] and conductor cross section range [mm <sup>2</sup> ] data: 10A/MSTBC-MT 0,5-1,0 (3190564); 10A/MSTBC-MT 0,5-1,0 BA (3190645); 12A/MSTBC-MT 1,5-2,5 (3190551); 12A/MSTBC-MT 1,5-2,5 BA (3190658). BA = Bandkontakte
1769159	MSTBP 2,5/16-ST-5,08	Plug component, Nominal current: 12 A, Rated voltage (III/2): 320 V, Number of positions: 16, Pitch: 5.08 mm, Connection method: Screw connection, Color: green, Contact surface: Tin
1792388	MVSTBR 2,5/16-ST-5,08	Plug component, Nominal current: 12 A, Rated voltage (III/2): 320 V, Number of positions: 16, Pitch: 5.08 mm, Connection method: Screw connection, Color: green, Contact surface: Tin
1792896	MVSTBW 2,5/16-ST-5,08	Plug component, Nominal current: 12 A, Rated voltage (III/2): 320 V, Number of positions: 16, Pitch: 5.08 mm, Connection method: Screw connection, Color: green, Contact surface: Tin
1883844	QC 1/16-ST-5,08	Plug component, Nominal current: 10 A, Rated voltage (III/2): 630 V, Number of positions: 16, Pitch: 5.08 mm, Connection method: Insulation displacement connection QUICKON, Color: green, Contact surface: Tin

1826429	SMSTB 2,5/16-ST-5,08	Plug component, Nominal current: 12 A, Rated voltage (III/2): 320 V, Number of positions: 16, Pitch: 5.08 mm, Connection method: Screw connection, Color: green, Contact surface: Tin
---------	----------------------	---

## Drawings

### Dimensioned drawing

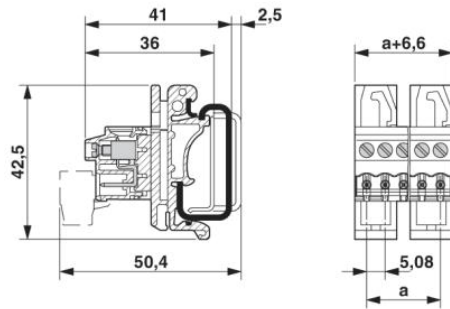

Connection data incl. use groups

---





**Address**

PHOENIX CONTACT Deutschland GmbH  
Flachmarktstr. 8  
32825 Blomberg, Germany  
Phone +49 5235 3 12000  
Fax +49 5235 3 41200  
<http://www.phoenixcontact.de>



© 2012 Phoenix Contact  
Technical modifications reserved;