

UMSTBVK 2,5/ 7-G-5,08

Order No.: 1788169

The figure shows a 10-position version of the product

<http://catalog.phoenixcontact.net/phoenix/treeViewClick.do?UID=1788169>

Plug component, Nominal current: 12 A, Rated voltage (III/2): 320 V,
Number of positions: 7, Pitch: 5.08 mm, Connection method: Screw
connection, Color: green, Contact surface: Tin, Assembly: DIN rail

Commercial data	
EAN	 4 017918 043223
Pack	50 Pcs.
Customs tariff	85366990
Product key	105121
Catalog page information	Page 333 (CC-2011)

Product notes

WEEE/RoHS-compliant since:
01/01/2003



<http://www.download.phoenixcontact.com>
Please note that the data given here has been taken from the online catalog. For comprehensive information and data, please refer to the user documentation. The General Terms and Conditions of Use apply to Internet downloads.

Technical data	
Dimensions / positions	
Width	42.5 mm
Pitch	5.08 mm
Dimension a	30.48 mm
Number of positions	7

Screw thread	M3
Tightening torque, min	0.5 Nm
Tightening torque max	0.6 Nm

Technical data

Range of articles	UMSTBVK 2,5/...-G
Insulating material group	I
Rated surge voltage (III/3)	4 kV
Rated surge voltage (III/2)	4 kV
Rated surge voltage (II/2)	4 kV
Rated voltage (III/2)	320 V
Rated voltage (II/2)	630 V
Connection in acc. with standard	EN-VDE
Nominal current I_N	12 A
Nominal voltage U_N	320 V
Nominal cross section	2.5 mm ²
Insulating material	PA
Inflammability class according to UL 94	V2
Internal cylindrical gage	A3
Stripping length	7 mm

Connection data

Conductor cross section solid min.	0.2 mm ²
Conductor cross section solid max.	2.5 mm ²
Conductor cross section stranded min.	0.2 mm ²
Conductor cross section stranded max.	2.5 mm ²
Conductor cross section stranded, with ferrule without plastic sleeve min.	0.25 mm ²
Conductor cross section stranded, with ferrule without plastic sleeve max.	2.5 mm ²
Conductor cross section stranded, with ferrule with plastic sleeve min.	0.25 mm ²
Conductor cross section stranded, with ferrule with plastic sleeve max.	2.5 mm ²
2 conductors with same cross section, solid min.	0.2 mm ²
2 conductors with same cross section, solid max.	1 mm ²
2 conductors with same cross section, stranded min.	0.2 mm ²

2 conductors with same cross section, stranded max.	1.5 mm ²
2 conductors with same cross section, stranded, ferrules without plastic sleeve, min.	0.25 mm ²
2 conductors with same cross section, stranded, ferrules without plastic sleeve, max.	1 mm ²
2 conductors with same cross section, stranded, TWIN ferrules with plastic sleeve, min.	0.5 mm ²
2 conductors with same cross section, stranded, TWIN ferrules with plastic sleeve, max.	1.5 mm ²
Conductor cross section AWG/kcmil min.	24
Conductor cross section AWG/kcmil max	12

Certificates / Approvals

Certification CB, CSA, CUL, GOST, UL, VDE-PZI

Accessories

Item	Designation	Description
Assembly		
1755477	MSTB-BL	Keying cap, for forming sections, plugs onto header pin, green insulating material
General		
1733169	EBP 2- 5	Insertion bridge, fully insulated, for plug connectors with 5.0 or 5.08 mm pitch, no. of positions: 2
Marking		
0804293	SK 5,08/3,8:FORTL.ZAHLEN	Marker cards, Card, white, Labeled, Horizontal: Consecutive numbers 1 - 10, 11 - 20, etc. up to 91 - (99)100, Mounting type: Adhesive, For terminal block width: 5.08 mm
Plug/Adapter		
1734401	CR-MSTB	Coding section, inserted into the recess in the header or the inverted plug, red insulating material
Tools		
1205053	SZS 0,6X3,5	Actuation tool, for ST terminal blocks, insulated, also suitable for use as a bladed screwdriver, size: 0.6 x 3.5 x 100 mm, 2-component grip, with non-slip grip

Additional products

Item	Designation	Description
General		
1873100	FKC 2,5/ 7-ST-5,08	Plug component, Nominal current: 12 A, Rated voltage (III/2): 320 V, Number of positions: 7, Pitch: 5.08 mm, Connection method: Spring-cage conn., Color: green, Contact surface: Tin
1874002	FKCVR 2,5/ 7-ST-5,08	Plug component, Nominal current: 12 A, Rated voltage (III/2): 320 V, Number of positions: 7, Pitch: 5.08 mm, Connection method: Spring-cage conn., Color: green, Contact surface: Tin
1777332	FRONT-MSTB 2,5/ 7-ST-5,08	Plug component, Nominal current: 12 A, Rated voltage (III/2): 320 V, Number of positions: 7, Pitch: 5.08 mm, Connection method: Screw connection, Color: green, Contact surface: Tin
1757064	MSTB 2,5/ 7-ST-5,08	Plug component, Nominal current: 12 A, Rated voltage (III/2): 320 V, Number of positions: 7, Pitch: 5.08 mm, Connection method: Screw connection, Color: green, Contact surface: Tin
1776113	MSTB 2,5/ 7-STZ-5,08	Plug component, Nominal current: 12 A, Rated voltage (III/2): 320 V, Number of positions: 7, Pitch: 5.08 mm, Connection method: Screw connection, Color: green, Contact surface: Tin
1808861	MSTBC 2,5/ 7-ST-5,08	Plug component, Nominal current: 12 A, Rated voltage (III/2): 320 V, Number of positions: 7, Pitch: 5.08 mm, Connection method: Crimp connection, Color: green, Corresponding female crimp contacts with current [A] and conductor cross section range [mm ²] data: 10A/MSTBC-MT 0,5-1,0 (3190564); 10A/MSTBC-MT 0,5-1,0 BA (3190645); 12A/MSTBC-MT 1,5-2,5 (3190551); 12A/MSTBC-MT 1,5-2,5 BA (3190658). BA = Bandkontakte
1809556	MSTBC 2,5/ 7-STZ-5,08	Plug component, Nominal current: 12 A, Rated voltage (III/2): 320 V, Number of positions: 7, Pitch: 5.08 mm, Connection method: Crimp connection, Color: green, Corresponding female crimp contacts with current [A] and conductor cross section range [mm ²] data: 10A/MSTBC-MT 0,5-1,0 (3190564); 10A/MSTBC-MT 0,5-1,0 BA (3190645); 12A/MSTBC-MT 1,5-2,5 (3190551); 12A/MSTBC-MT 1,5-2,5 BA (3190658). BA = Bandkontakte
1850482	MSTBO 2,5/ 7-GL-5,08	Header, Nominal current: 8 A, Rated voltage (III/2): 320 V, Number of positions: 7, Pitch: 5.08 mm, Color: green, Contact surface: Tin, Assembly: Soldering
1847152	MSTBO 2,5/ 7-GR-5,08	Header, Nominal current: 8 A, Rated voltage (III/2): 320 V, Number of positions: 7, Pitch: 5.08 mm, Color: green, Contact surface: Tin, Assembly: Soldering
1769065	MSTBP 2,5/ 7-ST-5,08	Plug component, Nominal current: 12 A, Rated voltage (III/2): 320 V, Number of positions: 7, Pitch: 5.08 mm, Connection method: Screw connection, Color: green, Contact surface: Tin
1792294	MVSTBR 2,5/ 7-ST-5,08	Plug component, Nominal current: 12 A, Rated voltage (III/2): 320 V, Number of positions: 7, Pitch: 5.08 mm, Connection method: Screw connection, Color: green, Contact surface: Tin

1792809	MVSTBW 2,5/ 7-ST-5,08	Plug component, Nominal current: 12 A, Rated voltage (III/2): 320 V, Number of positions: 7, Pitch: 5.08 mm, Connection method: Screw connection, Color: green, Contact surface: Tin
1883307	QC 1/ 7-ST-5,08	Plug component, Nominal current: 10 A, Rated voltage (III/2): 630 V, Number of positions: 7, Pitch: 5.08 mm, Connection method: Insulation displacement connection QUICKON, Color: green, Contact surface: Tin
1826335	SMSTB 2,5/ 7-ST-5,08	Plug component, Nominal current: 12 A, Rated voltage (III/2): 320 V, Number of positions: 7, Pitch: 5.08 mm, Connection method: Screw connection, Color: green, Contact surface: Tin

Drawings

Dimensioned drawing

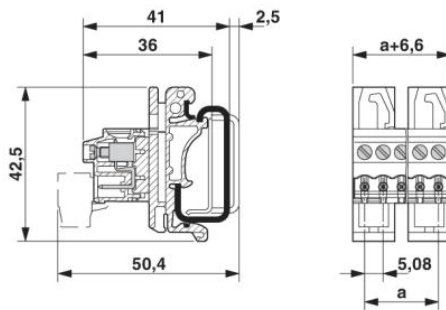

Connection data incl. use groups





Address

PHOENIX CONTACT Deutschland GmbH
Flachmarktstr. 8
32825 Blomberg, Germany
Phone +49 5235 3 12000
Fax +49 5235 3 41200
<http://www.phoenixcontact.de>



© 2012 Phoenix Contact
Technical modifications reserved;