



POWER SUPPLY

- 3AC 380-480V Wide-range Input
- Three Input Fuses Included
- Width only 110mm, Weight only 1.5kg
- 95.3% Full Load and Excellent Partial Load Efficiencies
- 50% BonusPower®, 1440W for up to 4s
- 83A Peak Current for 25ms for Easy Fuse Tripping
- Active PFC (Power Factor Correction)
- Active Filtering of Input Transients
- Negligible Low Input Inrush Current Surge
- Full Power Between -25°C and +60°C
- Current Sharing Feature for Parallel Use
- Internal Data Logging for Troubleshooting Included.
- Remote Control of Output Voltage
- DC-OK Relay Contact
- Shut-down Input
- 3 Year Warranty

GENERAL DESCRIPTION

The most outstanding features of the DIMENSION Q-Series DIN-rail power supplies are the extremely high efficiencies and the small sizes, which are achieved by a synchronous rectification and other technological designs.

Large power reserves of 150% support the starting of heavy loads such as DC-motors or capacitive loads. In many cases this allows the use of a unit from a lower wattage class which saves space and money.

High immunity to transients and power surges as well as low electromagnetic emission makes usage in nearly every environment possible.

The integrated output power manager, the three input fuses and near zero input inrush current make installation and usage simple. Diagnostics are easy due to the DC-ok relay, a green DC-OK LED and the red overload LED.

A large international approval package for a variety of applications makes this unit suitable for nearly every application.

SHORT-FORM DATA

Output voltage	DC 36V	nominal
Adjustment range	36 - 42V	
Output current	26.7 – 22.9A	continuous
	40 – 34.4A	short term (4s)
Output power	960W	continuous
	1440W	short term (4s)
Output ripple	< 130mVpp	20Hz to 20MHz
Input voltage	3AC 380-480V	-15%/+20%
Mains frequency	50-60Hz	±6%
AC Input current	1.65 / 1.35A	at 3x400 / 480Vac
Power factor	0.88 / 0.90	at 3x400 / 480Vac
AC Inrush current	typ. 4.5A peak	
Efficiency	95.3 / 95.2%	at 3x400 / 480Vac
Losses	47.3 / 48.4W	at 3x400 / 480Vac
Temperature range	-25°C to +70°C	operational
Derating	24W/°C	+60 to +70°C
Hold-up time	typ. 25 / 25ms	at 3x400 / 480Vac
Dimensions	110x124x127mm	WxHxD

ORDER NUMBERS

Power Supply	QT40.361	36-42V Standard unit
Accessory	ZM2.WALL	Wall mount bracket

MARKINGS





INDEX

	Page		Page
1. Intended Use	3	22. Approvals	18
2. Installation Requirements	3	23. Fulfilled Standards	18
3. AC-Input	4	24. Physical Dimensions and Weight	19
4. Input Inrush Current	5	25. Accessories	20
5. DC-Input	5	25.1. ZM2.WALL - Wall mounting bracket	20
6. Output	6	26. Application Notes	21
7. Hold-up Time	8	26.1. Repetitive Pulse Loading	21
8. DC-OK Relay Contact	9	26.2. Peak Current Capability	22
9. Shut-down Input	9	26.3. External Input Protection	22
10. Remote Control of Output Voltage	10	26.4. Using only 2 Legs of a 3-Phase System	23
11. Internal Data Logging	10	26.5. Charging of Batteries	24
12. Efficiency and Power Losses	11	26.6. Output Circuit Breakers	24
13. Reliability	12	26.7. Parallel Use to Increase Output Power	25
14. Functional Diagram	12	26.8. Parallel Use for Redundancy	25
15. Terminals and Wiring	13	26.9. Series Operation	26
16. Front Side and User Elements	14	26.10. Inductive and Capacitive Loads	26
17. EMC	15	26.11. Back-feeding Loads	26
18. Environment	16	26.12. Use in a Tightly Sealed Enclosure	26
19. Protection Features	17	26.13. Mounting Orientations	27
20. Safety Features	17		
21. Dielectric Strength	17		

The information presented in this document is believed to be accurate and reliable and may change without notice. No part of this document may be reproduced or utilized in any form without permission in writing from the publisher.

TERMINOLOGY AND ABBREVIATIONS

PE and  symbol	PE is the abbreviation for Protective Earth and has the same meaning as the symbol  .
Earth, Ground	This document uses the term "earth" which is the same as the U.S. term "ground".
T.b.d.	To be defined, value or description will follow later.
AC 400V	A figure displayed with the AC or DC before the value represents a nominal voltage with standard tolerances (usually $\pm 15\%$) included. E.g.: DC 12V describes a 12V battery disregarding whether it is full (13.7V) or flat (10V)
400Vac	A figure with the unit (Vac) at the end is a momentary figure without any additional tolerances included.
50Hz vs. 60Hz	As long as not otherwise stated, AC 230V parameters are valid at 50Hz mains frequency.
may	A key word indicating flexibility of choice with no implied preference.
shall	A key word indicating a mandatory requirement.
should	A key word indicating flexibility of choice with a strongly preferred implementation.

1. INTENDED USE

This device is designed for installation in an enclosure and is intended for the general use such as in industrial control, office, communication, and instrumentation equipment.

Do not use this power supply in equipment, where malfunction may cause severe personal injury or threaten human life.

This device is designed for use in non-hazardous, ordinary or unclassified locations.

2. INSTALLATION REQUIREMENTS

This device may only be installed and put into operation by qualified personnel.

This device does not contain serviceable parts. The tripping of an internal fuse is caused by an internal defect.

If damage or malfunction should occur during installation or operation, immediately turn power off and send unit to the factory for inspection.

Mount the unit on a DIN-rail so that the output and input terminals are located on the bottom of the unit. For other mounting orientations see de-rating requirements in this document. See chapter 26.13.

This device is designed for convection cooling and does not require an external fan. Do not obstruct airflow and do not cover ventilation grid (e.g. cable conduits) by more than 15%!

Keep the following installation clearances: 40mm on top, 20mm on the bottom, 5mm on the left and right sides are recommended when the device is loaded permanently with more than 50% of the rated power. Increase this clearance to 15mm in case the adjacent device is a heat source (e.g. another power supply).

⚠ WARNING Risk of electrical shock, fire, personal injury or death.

- Do not use the power supply without proper grounding (Protective Earth). Use the terminal on the input block for earth connection and not one of the screws on the housing.
- Turn power off before working on the device. Protect against inadvertent re-powering.
- Make sure that the wiring is correct by following all local and national codes.
- Do not modify or repair the unit.
- Do not open the unit as high voltages are present inside.
- Use caution to prevent any foreign objects from entering the housing.
- Do not use in wet locations or in areas where moisture or condensation can be expected.
- Do not touch during power-on, and immediately after power-off. Hot surfaces may cause burns.

3. AC-INPUT

AC input	nom.	3AC 380-480V	suitable for TN, TT and IT mains networks, grounding of one phase is allowed except in UL 508 applications
AC input range	min.	3x 323-576Vac	continuous operation
Allowed voltage L to earth	max.	576Vac	continuous, IEC 60664-1
Input frequency	nom.	50–60Hz	±6%
Turn-on voltage	typ.	3x 305Vac	steady-state value, load independent, see Fig. 3-1
Shut-down voltage	typ.	3x 275Vac	steady-state value, load independent, see Fig. 3-1

		3AC 400V	3AC 480V	
Input current	typ.	1.65A	1.35A	at 36V, 26.7A, symmetrical phase voltages, see Fig. 3-3
Power factor ^{*)}	typ.	0.88	0.90	at 36V, 26.7A, see Fig. 3-4
Start-up delay	typ.	500ms	600ms	see Fig. 3-2
Rise time	typ.	40ms	40ms	at 36V, 26.7A, resistive load, 0mF see Fig. 3-2
	typ.	45ms	45ms	at 36V, 26.7A, resistive load, 27mF see Fig. 3-2
Turn-on overshoot	max.	750mV	750mV	see Fig. 3-2

*) The power factor is the ratio of the true (or real) power to the apparent power in an AC circuit.

Fig. 3-1 Input voltage range

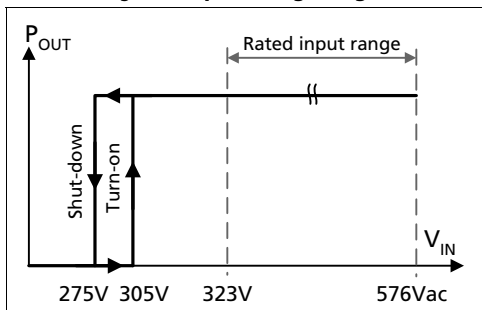

Fig. 3-2 Turn-on behavior, definitions

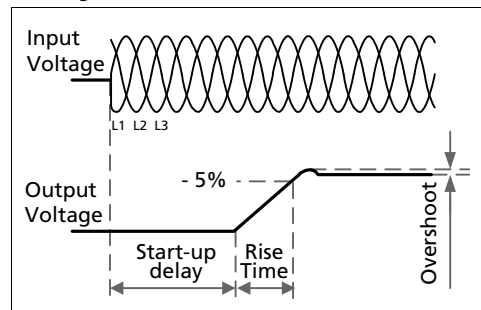

Fig. 3-3 Input current vs. output load at 36V

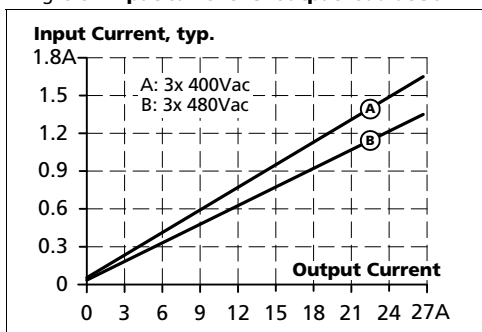
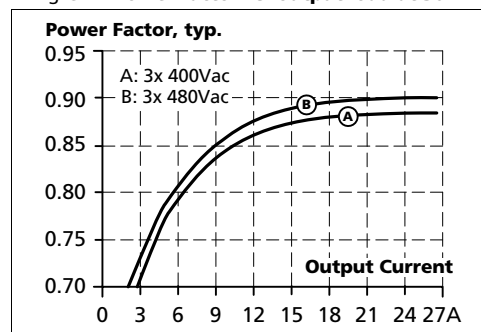

Fig. 3-4 Power factor vs. output load at 36V



4. INPUT INRUSH CURRENT

The power supply is equipped with an active inrush current limitation circuit, which limits the input inrush current after turn-on to a negligible low value. The input current is usually smaller than the steady state input current.

		3AC 400V	3AC 480V	
Inrush current ^{*)}	max.	6A _{peak}	6A _{peak}	over entire temperature range
	typ.	4.5A _{peak}	4.5A _{peak}	over entire temperature range
Inrush energy	max.	1.5A ² s	1.5A ² s	over entire temperature range
Inrush delay	typ.	500ms	600ms	

*) The charging current into EMI suppression capacitors is disregarded in the first microseconds after switch-on.

Fig. 4-1 Typical turn-on behaviour at nominal load and 25°C ambient temperature

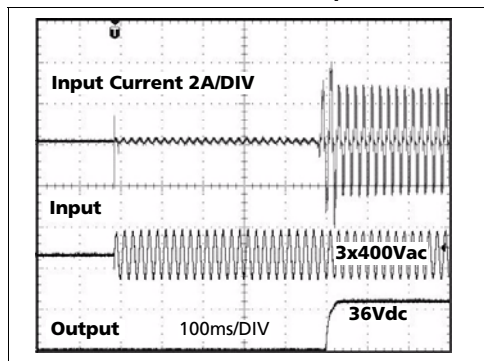

5. DC-INPUT

Do not operate this power supply with DC-input voltage.

6. OUTPUT

Output voltage	nom.	36V	
Adjustment range	min.	36-42V	guaranteed
	max.	45V ^{***)}	at clockwise end position of potentiometer
Factory setting	typ.	36.0V	±0.2%, at full load, cold unit, in "single use" mode
	typ.	36.0V	±0.2%, at full load, cold unit, in "parallel use" mode
	typ.	37.5V	at no load, cold unit, in "parallel use" mode
Line regulation	max.	10mV	3x323-576Vac
Load regulation	max.	50mV	in "single use" mode: static value, 0A→26A, see Fig. 6-1
	typ.	1500mV	in "parallel use" mode: static value, 0A→26A, see Fig. 6-2
Ripple and noise voltage	max.	130mVpp	20Hz to 20MHz, 50Ohm
Output current	nom.	26.7A	continuously available at 36V, see Fig. 6-1 and Fig. 6-2
	nom.	22.9A	continuously available at 42V, see Fig. 6-1 and Fig. 6-2
	nom.	40A	short term (4s) available BonusPower [®] *, at 36V, see Fig. 6-1, Fig. 6-2 and Fig. 6-4
	nom.	34.3A	short term (4s) available BonusPower [®] *, at 42V, see Fig. 6-1, Fig. 6-2 and Fig. 6-4
	typ.	73A	up to 25ms, output voltage stays above 30V, see Fig. 6-4, This peak current is available once every second. See chapter 26.2 for more peak current measurements.
Output power	nom.	960W	continuously available at 36-42V
	nom.	1440W ^{*)}	short term available BonusPower [®] *) at 36-42V
BonusPower [®] time	typ.	4s	duration until the output voltage dips, see Fig. 6-3
BonusPower [®] recovery time	typ.	7s	overload free time to reset power manager, see Fig. 6-5
Overload behavior		cont. current	see Fig. 6-1
Short-circuit current ^{**)}	min.	27A	continuous, load impedance 40mOhm, see Fig. 6-1
	max.	30A	continuous, load impedance 40mOhm, see Fig. 6-1
	min.	40A	short-term (4s), load impedance 40mOhm, see Fig. 6-1
	max.	45A	short-term (4s), load impedance 40mOhm, see Fig. 6-1
	typ.	33A	continuous, load impedance <10mOhm
	max.	37A	continuous, load impedance <10mOhm
Output capacitance	typ.	4 700µF	included in the power supply

*) **BonusPower[®], short term power capability (up to typ. 4s)**

The power supply is designed to support loads with a higher short-term power requirement without damage or shutdown. The short-term duration is hardware controlled by an output power manager. This BonusPower[®] is repeatedly available. Detailed information can be found in chapter 26.1. If the power supply is loaded longer with the BonusPower[®] than shown in the bonus-time diagram (see Fig. 6-3), the max. output power is automatically reduced to 960W.

***) Discharge current of output capacitors is not included.

****) This is the maximum output voltage which can occur at the clockwise end position of the potentiometer due to tolerances. It is not guaranteed value which can be achieved. The typical value is about 42.5V.

Fig. 6-1 **Output voltage vs. output current in "single use" mode, typ.**

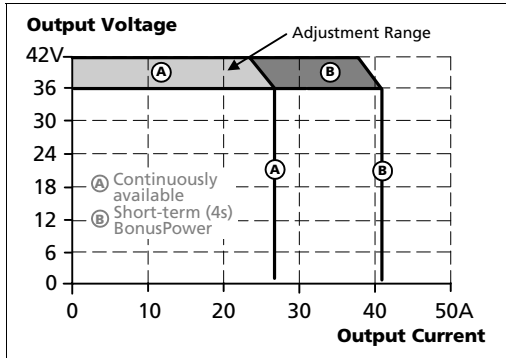

Fig. 6-2 **Output voltage vs. output current in "parallel use" mode, typ.**

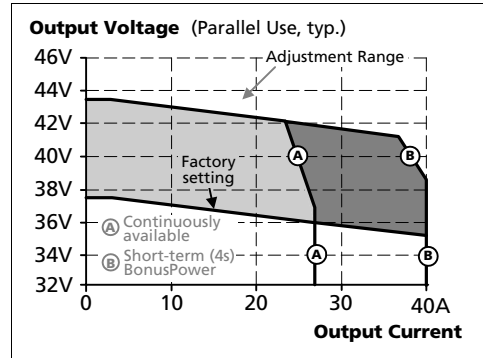

Fig. 6-3 **Bonus time vs. output power**

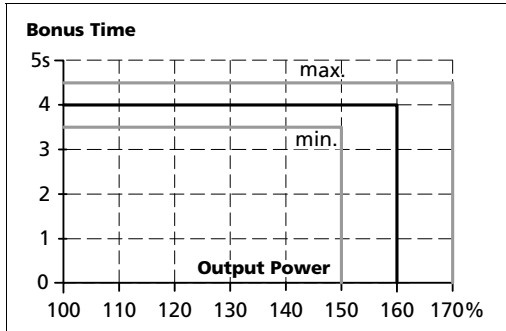

Fig. 6-4 **Dynamic overcurrent capability, typ.**

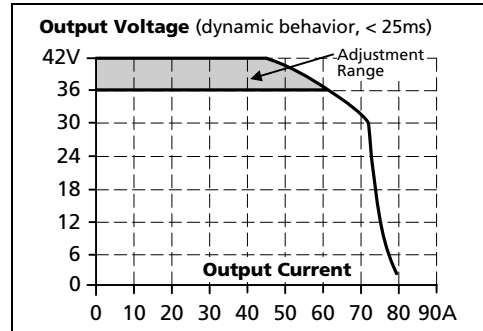
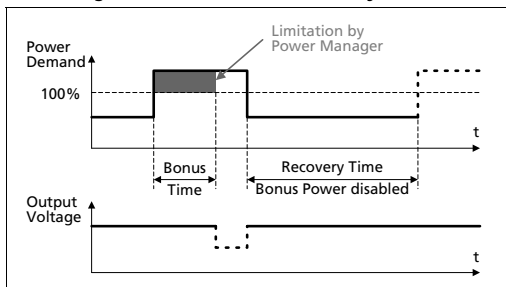

Fig. 6-5 **BonusPower® recovery time**



The BonusPower® is available as soon as power comes on and after the end of an output short circuit or output overload.

Fig. 6-6 **BonusPower® after input turn-on**

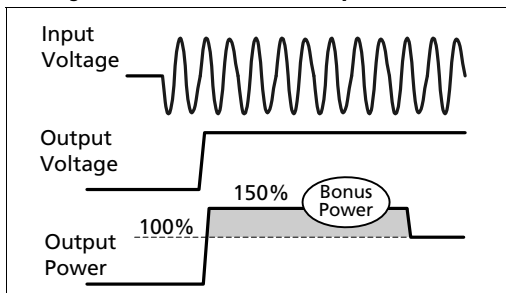
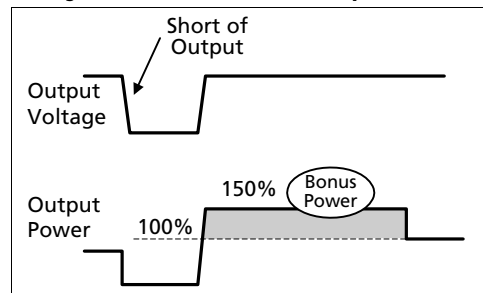

Fig. 6-7 **BonusPower® after output short**



7. HOLD-UP TIME

		3AC 400V ^{*)}	3AC 480V ^{*)}	
Hold-up Time	typ.	50ms	50ms	at 36V, 13.3A, see Fig. 7-1
	min.	40ms	40ms	at 36V, 13.3A, see Fig. 7-1
	typ.	25ms	25ms	at 36V, 26.7A, see Fig. 7-1
	min.	20ms	20ms	at 36V, 26.7A, see Fig. 7-1

^{*)} Curves and figures for operation on only 2 legs of a 3-phase system can be found in chapter 26.4

Fig. 7-1 Hold-up time vs. input voltage

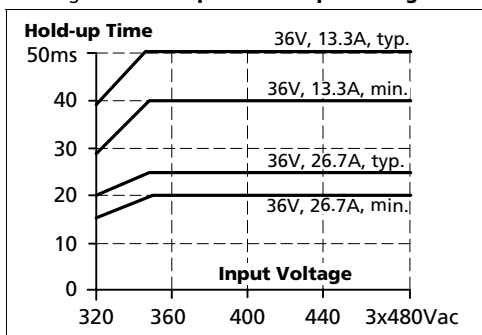
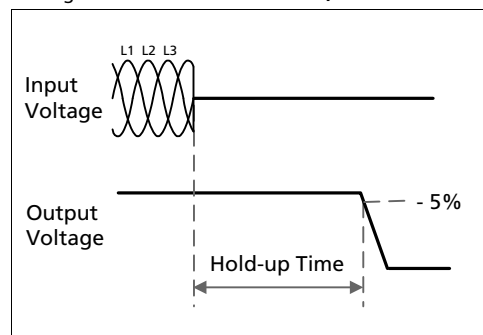

Fig. 7-2 Shut-down behavior, definitions



8. DC-OK RELAY CONTACT

This feature monitors the output voltage, which is produced by the power supply itself. It is independent of a back-fed voltage from a unit connected in parallel to the power supply output.

Contact closes	As soon as the output voltage reaches 90% of the adjusted output voltage.		
Contact opens	As soon as the output voltage dips more than 10% below the adjusted output voltage. Short dips will be extended to a signal length of 250ms. Dips shorter than 1ms will be ignored.		
Contact re-closes	As soon as the output voltage exceeds 90% of the adjusted voltage.		
Contact ratings	max	60Vdc 0.3A, 30Vdc 1A, 30Vac 0.5A	resistive load
	min	1mA at 5Vdc	min. permissible load
Isolation voltage	See dielectric strength table in section 21.		

Fig. 8-1 DC-ok relay contact behavior

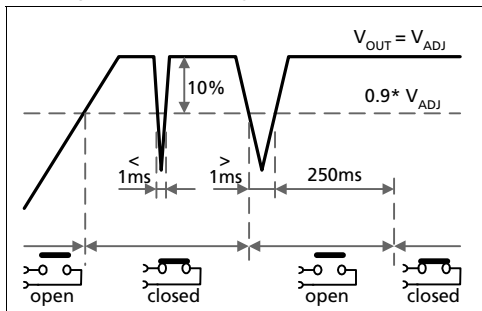

9. SHUT-DOWN INPUT

This feature allows a switch-off of the output of the power supply with a signal switch or an external voltage. The shut-down function ramps down and has no safety feature included. The shut-down occurs immediately while the turn-on is delayed up to 350ms. In a shut-down condition, the output voltage is $<3V$ and the output power is $<0.5W$.

The voltage between different minus pole output terminals must be below 1V when units are connected in parallel. In a series operation of multiple power supplies only wiring option "A" with individual signal switches is allowed.

Please note that option C requires a current sink capability of the voltage source. Do not use a blocking diode.

Fig. 9-1 Activation of the shut-down input

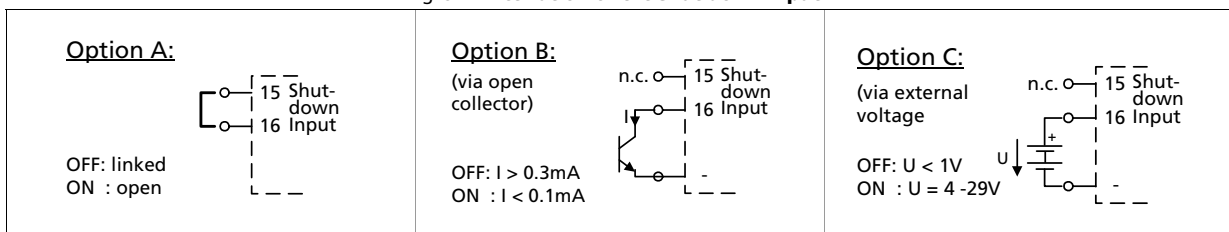

10. REMOTE CONTROL OF OUTPUT VOLTAGE

The shut-down input can also be used to remotely adjust the output voltage between typically 21Vdc and 42Vdc. All other functions of shut-down input remain the same.

The control voltage is referenced to the main ground (negative output voltage)

Fig. 10-1 Remote control of the output voltage

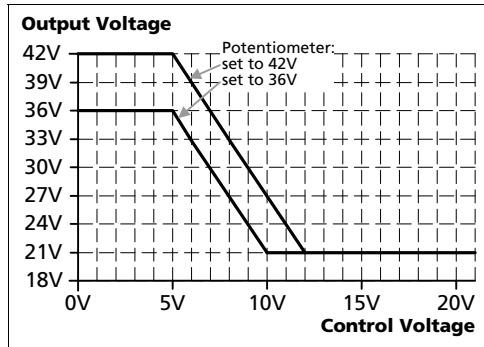
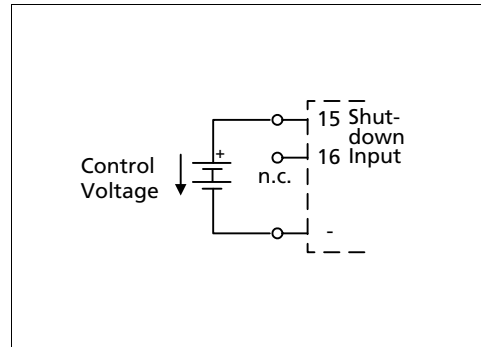

Fig. 10-2 Applying the control voltage



Instructions:

1. Set the unit into "Single Use" mode
2. Set the output voltage adjustment (36-42V) to the maximum desired voltage.
3. Apply a control voltage to reduce the output voltage

11. INTERNAL DATA LOGGING

A protected microcontroller inside the power supply acquires and stores operating data during the life of the unit. The data can be downloaded with a small tool and a special software by the PULS service and repair personnel, even when the unit is defect. The data allows for better troubleshooting. Analysis of what happened before a failure can be determined much more accurately.

The data will be acquired with a fixed sampling rate unless the peak detectors do trigger due to an abnormal condition. In such cases, the abnormal condition will be captured.

Acquired data:

- Family name of unit (QT40), revision of firmware
- Operational hours and expired portion of lifetime
- Operational data; latest 60 values with timestamps of the last 158 minutes of:
 - Number of over-voltage transients,
 - Average input voltage,
 - Peak input voltage,
 - Inside temperature,
 - Overloads > 2s,
 - Missing of one input phase (minimum output load required)
- Failure data; various errors such as:
 - Internal errors,
 - Over-temperature shut-down,
 - OVP,
 - Long-term overloads,
 - Remarkable temperatures inside the unit,
 -
- Number of turn-on sequences and overvoltage transients

12. EFFICIENCY AND POWER LOSSES

Efficiencies for 3-Phase operation:

		3AC 400V	3AC 480V	
Efficiency	typ.	95.3%	95.2%	at 36V, 26.7A
Average efficiency ^{*)}	typ.	94.7%	94.6%	25% at 6.7A, 25% at 13.3A, 25% at 20A, 25% at 26.7A
Power losses	typ.	1.5W	1.5W	with activated shut-down
	typ.	9.5W	9.8W	at 36V, 0A (no load)
	typ.	24.1W	25.0W	at 36V, 13.3A (half load)
	typ.	47.3W	48.4W	at 36V, 26.7A (full load)

*) The average efficiency is an assumption for a typical application where the power supply is loaded with 25% of the nominal load for 25% of the time, 50% of the nominal load for another 25% of the time, 75% of the nominal load for another 25% of the time and with 100% of the nominal load for the rest of the time.

Efficiencies when using only 2 legs of a 3-phase system:

		2AC 400V	2AC 480V	
Efficiency	typ.	94.4%**)	94.7%**)	at 36V, 26.7A
Power losses	typ.	56.9W**)	53.7W**)	at 36V, 26.7A (full load)

***) Curves can be found in chapter 26.4

Fig. 12-1 **Efficiency vs. output current at 36V, typ.**

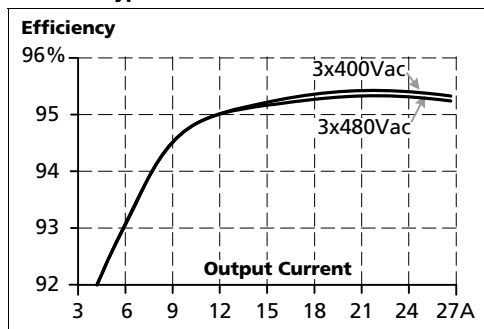

Fig. 12-2 **Losses vs. output current at 36V, typ.**

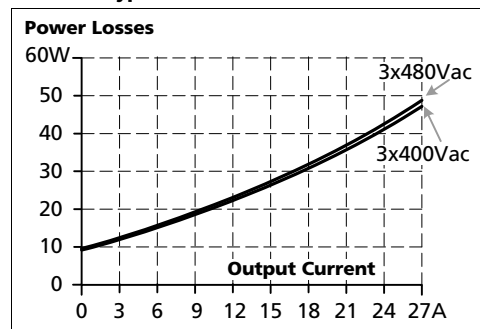

Fig. 12-3 **Efficiency vs. input voltage at 36V, 26.7A, typ.**

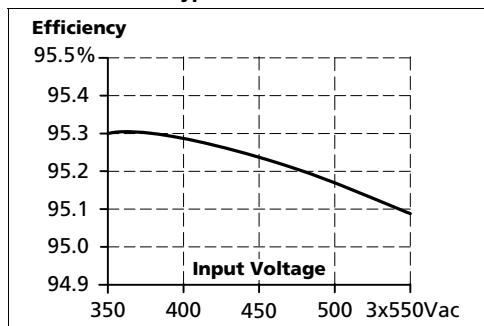
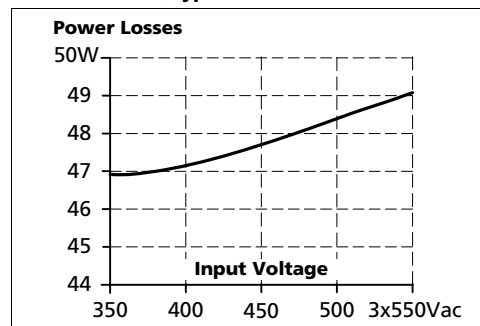

Fig. 12-4 **Losses vs. input voltage at 36V, 26.7A, typ.**



13. RELIABILITY

	3AC 400V	3AC 480V	
Calculated lifetime expectancy ^{*)}	314 000h ^{*)}	294 000h ^{*)}	at 36V, 13.3A and 25°C
	111 000h	104 000h	at 36V, 13.3A and 40°C
	179 000h ^{*)}	174 000h ^{*)}	at 36V, 26.7A and 25°C
	63 000h	62 000h	at 36V, 26.7A and 40°C
MTBF ^{**) SN 29500, IEC 61709}	375 000h	369 000h	at 36V, 26.7A and 40°C
	685 000h	678 000h	at 36V, 26.7A and 25°C
MTBF ^{**) MIL HDBK 217F}	158 000h	157 000h	at 36V, 26.7A and 40°C; Ground Benign GB40
	211 000h	210 000h	at 36V, 26.7A and 25°C; Ground Benign GB25

*) The **calculated lifetime expectancy** shown in the table indicates the minimum operating hours (service life) and is determined by the lifetime expectancy of the built-in electrolytic capacitors. Lifetime expectancy is specified in operational hours and is calculated according to the capacitor's manufacturer specification. The manufacturer of the electrolytic capacitors only guarantees a maximum life of up to 15 years (131 400h). Any number exceeding this value is a calculated theoretical lifetime which can be used to compare devices.

) **MTBF stands for **Mean Time Between Failure**, which is calculated according to statistical device failures, and indicates reliability of a device. It is the statistical representation of the likelihood of a unit to fail and does not necessarily represent the life of a product. The MTBF figure is a statistical representation of the likelihood of a device to fail. A MTBF figure of e.g. 1 000 000h means that statistically one unit will fail every 100 hours if 10 000 units are installed in the field. However, it can not be determined if the failed unit has been running for 50 000h or only for 100h.

14. FUNCTIONAL DIAGRAM

Fig. 14-1 Functional diagram

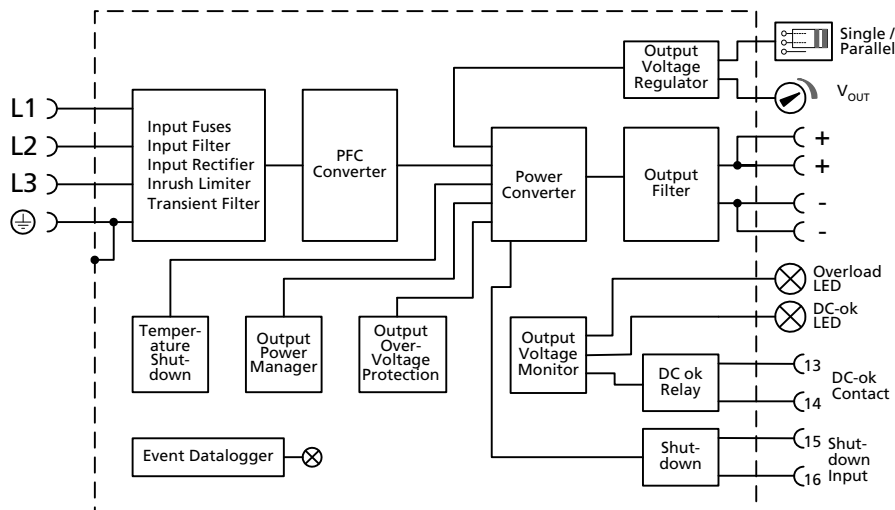

15. TERMINALS AND WIRING

The terminals are IP20 Finger safe constructed and suitable for field and factory wiring.

	Input	Output	DC-OK, Shut-down
Type	screw termination	screw termination	spring-clamp termination
Solid wire	0.5-6mm ²	0.5-16mm ²	0.15-1.5mm ²
Stranded wire	0.5-4mm ²	0.5-10mm ²	0.15-1.5mm ²
American Wire Gauge	AWG 20-10	AWG 22-8	AWG 26-14
Max. wire diameter	2.8mm (including ferrules)	5.2mm (including ferrules)	1.5mm (including ferrules)
Wire stripping length	7mm / 0.28inch	12mm / 0.5inch	7mm / 0.28inch
Screwdriver	3.5mm slotted or cross-head No 2	3.5mm or 5mm slotted or cross-head No 2	3mm slotted (to open the spring)
Recommended tightening torque	1Nm, 9lb.in	2.3Nm, 20.5lb.in	Not applicable

Instructions:

- a) Use appropriate copper cables that are designed for minimum operating temperatures of:
 60°C for ambient up to 45°C and
 75°C for ambient up to 60°C minimum
 90°C for ambient up to 70°C minimum.
- b) Follow national installation codes and installation regulations!
- c) Ensure that all strands of a stranded wire enter the terminal connection!
- d) Do not use the unit without PE connection.
- e) Unused terminal compartments should be securely tightened.
- f) Ferrules are allowed.

Daisy chaining:

Daisy chaining (jumping from one power supply output to the next) is allowed as long as the average output current through one terminal pin does not exceed 54A. If the current is higher, use a separate distribution terminal block as shown in Fig. 15-2.

Fig. 15-1 Daisy chaining of outputs

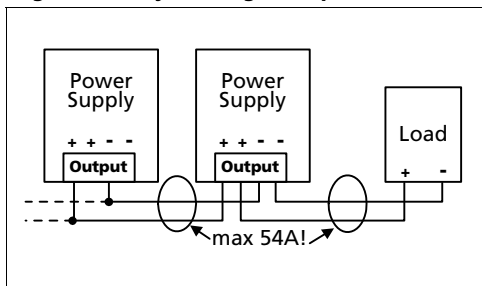
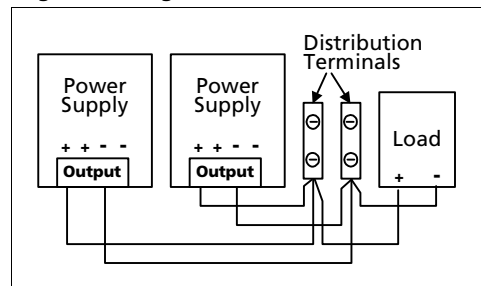
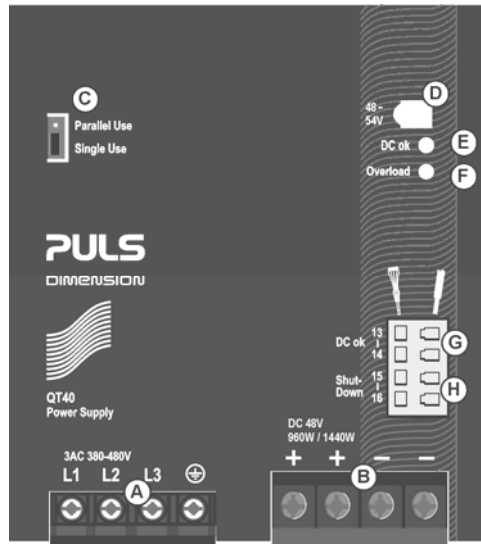

Fig. 15-2 Using distribution terminals



16. FRONT SIDE AND USER ELEMENTS

Fig. 16-1 Front side



- A Input Terminals** (Screw terminals)
L1, L2, L3 Line input
 \oplus ...PE (Protective Earth) input
- B Output Terminals** (Screw terminals, two pins per pole)
+ Positive output
- Negative (return) output
- C "Parallel Use" "Single Use" Selector**
 Set jumper to "Parallel Use" when power supplies are connected in parallel to increase the output power. In order to achieve a sharing of the load current between the individual power supplies, the "parallel use" regulates the output voltage in such a manner that the voltage at no load is approx. 4% higher than at nominal load. See also chapter 26.7. A missing jumper is equal to a "Single Use" mode.
- D Output Voltage Potentiometer**
 Multi turn potentiometer;
 Open the flap to set the output voltage.
 Factory set: 48.0V at full output current, "Single Use" mode.
- E DC-OK LED** (green)
 On, when the voltage on the output terminals is >90% of the adjusted output voltage
- F Overload LED** (red)
 - On, when the voltage on the output terminals is <90% of the adjusted output voltage, or in case of a short circuit in the output.
 - Flashing, when the shut-down has been activated or the unit has switched off due to over-temperature.
 - Input voltage is required
- G DC-OK Relay Contact**
 The DC-OK relay contact is synchronized with the DC-OK LED. See chapter 8 for details.
- H Shut-down and Remote Control Input**
 Allows the power supply to be shut down. Can be activated with a switch contact or an external voltage.
 The remote control input allows adjusting the output voltage between 21V and 42V. See chapter 9 and 10 for details.

Indicators, LEDs

	Overload LED	DC-OK LED	DC-OK Contact
Normal mode	OFF	ON	Closed
During BonusPower®	OFF	ON	Closed
Overload (Vout < 90%)	ON	OFF	Open
Output short circuit	ON	OFF	Open
Temperature Shut-down	flashing	OFF	Open
Active Shut-down input	flashing	OFF	Open
No input power	OFF	OFF	Open

17. EMC

The power supply is suitable for applications in industrial environment as well as in residential, commercial and light industry environment without any restrictions. A detailed EMC report is available on request.

EMC Immunity	According generic standards: EN 61000-6-1 and EN 61000-6-2			
Electrostatic discharge	EN 61000-4-2	contact discharge	8kV	Criterion A
		air discharge	15kV	Criterion A
Electromagnetic RF field	EN 61000-4-3	80MHz-2.7GHz	10V/m	Criterion A
Fast transients (Burst)	EN 61000-4-4	input lines	4kV	Criterion A
		output lines	2kV	Criterion A
		DC-OK signal (coupling clamp)	2kV	Criterion A
Surge voltage on input	EN 61000-4-5	L1 → L2, L2 → L3, L1 → L3	2kV	Criterion A
		L1 / L2 / L3 → PE	4kV	Criterion A
Surge voltage on output	EN 61000-4-5	+ → -	1kV	Criterion A
		+ / - → PE	1kV	Criterion A
Surge voltage on DC-OK	EN 61000-4-5	DC-OK signal → PE	1kV	Criterion A
Conducted disturbance	EN 61000-4-6	0.15-80MHz	10V	Criterion A
Mains voltage dips (Dips on three phases)	EN 61000-4-11	0% of 380Vac (0Vac)	0Vac, 20ms	Criterion A,
		0% of 480Vac (0Vac)	0Vac, 20ms	Criterion A
Mains voltage dips (Dips on two phases)	EN 61000-4-11	40% of 380Vac (152Vac)	200ms	Criterion A
		40% of 480Vac (192Vac)	200ms	Criterion A
		70% of 380Vac (266Vac)	500ms	Criterion A
		70% of 480Vac (336Vac)	500ms	Criterion A
Voltage interruptions	EN 61000-4-11	0% of 200Vac (=0V)	5000ms	Criterion C
Voltage sags	SEMI F47 0706	dips on two phases according to section 7.2. of the SEMI F47 standard		
		80% of 380Vac (304Vac)	1000ms	Criterion A
		70% of 380Vac (266Vac)	500ms	Criterion A
		50% of 380Vac (160Vac)	200ms	Criterion A
Powerful transients	VDE 0160	over entire load range	1550V, 1.3ms	Criterion A

Criteria:

A: Power supply shows normal operation behavior within the defined limits.

C: Temporary loss of function is possible. Power supply may shut-down and restarts by itself. No damage or hazards for the power supply will occur.

EMC Emission	According generic standards: EN 61000-6-3 and EN 61000-6-4	
Conducted emission input lines	EN 55011, EN 55022, FCC Part 15, CISPR 11, CISPR 22	Class B
Conducted emission output lines	IEC/CISPR 16-1-2, IEC/CISPR 16-2-1	5dB higher than average limits for DC power port according EN 61000-6-3**)
Radiated emission	EN 55011, EN 55022	Class B
Harmonic input current	EN 61000-3-2	fulfilled for class A equipment
Voltage fluctuations, flicker	EN 61000-3-3	fulfilled*)

This device complies with FCC Part 15 rules.

Operation is subjected to following two conditions: (1) this device may not cause harmful interference, and (2) this device must accept any interference received, including interference that may cause undesired operation.

*) Tested with constant current loads, non pulsing

***) Restrictions apply for applications in residential, commercial and light-industrial environments, where local DC power networks according to EN 61000-6-3 are involved. No restrictions for all kinds of industrial applications.

Switching Frequencies	The power supply has three converters with three different switching frequencies included. One is nearly constant. The others are variable.	
Switching frequency 1	105kHz	Resonant converter, nearly constant
Switching frequency 2	1kHz to 150kHz	Boost converter, load dependent
Switching frequency 3	40kHz to 300kHz	PFC converter, input voltage and load dependent

18. ENVIRONMENT

Operational temperature ^{*)}	-25°C to +70°C (-13°F to 158°F)	reduce output power according Fig. 18-1
Storage temperature	-40 to +85°C (-40°F to 185°F)	for storage and transportation
Output de-rating	24W/°C	60-70°C (140°F to 158°F)
Humidity ^{**)}	5 to 95% r.H.	IEC 60068-2-30
Vibration sinusoidal	2-17.8Hz: ±1.6mm; 17.8-500Hz: 1g ^{***)} 2 hours / axis	IEC 60068-2-6
Shock	15g 6ms, 10g 11ms ^{***)} 3 bumps / direction, 18 bumps in total	IEC 60068-2-27
Altitude	0 to 2000m (0 to 6 560ft) 2000 to 6000m (6 560 to 20 000ft)	without any restrictions reduce output power or ambient temperature, see Fig. 18-2
Altitude de-rating	60W/1000m or 5°C/1000m	IEC 62103, EN 50178, overvoltage category II > 2000m (6500ft), see Fig. 18-2
Over-voltage category	III II	IEC 62103, EN 50178, altitudes up to 2000m altitudes from 2000m to 6000m
Degree of pollution	2	IEC 62103, EN 50178, not conductive
LABS compatibility	The unit does not release any silicone or other LABS-critical substances and is suitable for use in paint shops.	

*) Operational temperature is the same as the ambient temperature and is defined as the air temperature 2cm below the unit. Curves and figures for operation on only 2 legs of a 3-phase system can be found in chapter 26.4.

***) Do not energize while condensation is present.

***) Higher levels allowed when using the wall mounting bracket ZM2.WALL

Fig. 18-1 Output current vs. ambient temp.

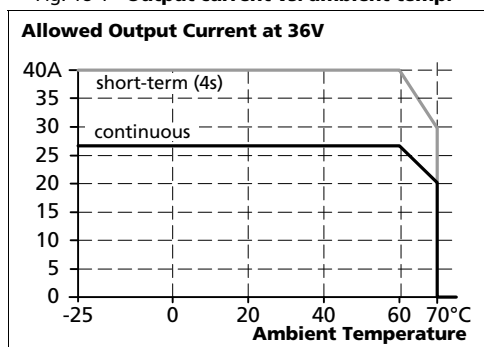
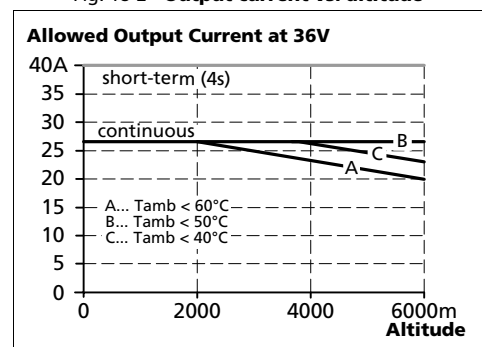

Fig. 18-2 Output current vs. altitude



19. PROTECTION FEATURES

Output protection	Electronically protected against overload, no-load and short-circuits ^{*)}	
Output over-voltage protection	typ. 45.5Vdc max. 48Vdc	In case of an internal power supply defect, a redundant circuit limits the maximum output voltage. The output shuts down and automatically attempts to restart.
Degree of protection	IP 20	EN/IEC 60529
Penetration protection	> 5mm	e.g. screws, small parts
Over-temperature protection	yes	Output shut-down with automatic restart
Input transient protection	MOV (Metal Oxide Varistor)	
Internal input fuse	included	not user replaceable

^{*)} In case of a protection event, audible noise may occur.

20. SAFETY FEATURES

Input / output separation ^{*)}	SELV PELV double or reinforced insulation	IEC/EN 60950-1 IEC/EN 60204-1, EN 50178, IEC 62103, IEC 60364-4-41
Class of protection	I	PE (Protective Earth) connection required
Isolation resistance	> 5MΩ	input to output, 500Vdc
PE resistance	< 0.1Ω	
Touch current (leakage current)	typ. 0.35mA / 0.64mA typ. 0.45mA / 0.91mA max. 0.45mA / 0.78mA max. 0.60mA / 1.20mA	3x400Vac, 50Hz, TN-,TT-mains / IT-mains 3x480Vac, 60Hz, TN-,TT-mains / IT-mains 3x440Vac, 50Hz, TN-,TT-mains / IT-mains 3x528Vac, 60Hz, TN-,TT-mains / IT-mains

^{*)} double or reinforced insulation

21. DIELECTRIC STRENGTH

The output voltage is floating and has no ohmic connection to the ground. Type and factory tests are conducted by the manufacturer. Field tests may be conducted in the field using the appropriate test equipment which applies the voltage with a slow ramp (2s up and 2s down). Connect all phase terminals together as well as all output poles before conducting the test. When testing, set the cut-off current settings to the value in the table below.

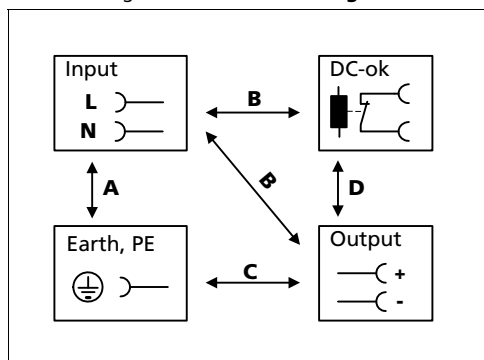

Fig. 21-1 Dielectric strength



		A	B	C	D
Type test	60s	2500Vac	3000Vac	500Vac	500Vac
Factory test	5s	2500Vac	2500Vac	500Vac	500Vac
Field test	5s	2000Vac	2000Vac	500Vac	500Vac
Cut-off current setting		> 10mA	> 10mA	> 40mA	> 1mA

To fulfil the PELV requirements according to EN 60204-1 § 6.4.1, we recommend that either the + pole, the - pole or any other part of the output circuit shall be connected to the protective earth system. This helps to avoid situations in which a load starts unexpectedly or can not be switched off when unnoticed earth faults occur.

22. APPROVALS

EC Declaration of Conformity		The CE mark indicates conformance with the - EMC directive 2004/108/EC, - Low-voltage directive (LVD) 2006/95/EC and - RoHS directive 2011/65/EC.
IEC 60950-1 2 nd Edition		CB Scheme, Information Technology Equipment
UL 508		Listed for use as Industrial Control Equipment; U.S.A. (UL 508) and Canada (C22.2 No. 107-1-01); E-File: E198865
UL 60950-1, 2 nd Edition		Recognized for use as Information Technology Equipment, Level 5; U.S.A. (UL 60950-1) and Canada (C22.2 No. 60950-1); E-File: E137006
GOST P		Certificate of Conformity for Russia and other GUS countries

23. FULFILLED STANDARDS

EN 61558-2-17	Safety of Power Transformers
IEC/EN 60204-1	Safety of Electrical Equipment of Machines
IEC/EN 61131-2	Programmable Controllers
EN 50178, IEC 62103	Electronic Equipment in Power Installations
SEMI F47-0706	Ride-through compliance for the semiconductor industry, fulfilled for 3AC 380V mains voltages and higher (Dips on two phases: 304Vac for 1000ms, 266Vac for 500ms and 190Vac for 200ms, Pout < 960W)

24. PHYSICAL DIMENSIONS AND WEIGHT

Weight	1500g / 3.3lb
DIN-Rail	Use 35mm DIN-rails according to EN 60715 or EN 50022 with a height of 7.5 or 15mm. The DIN-rail height must be added to the unit depth (127mm) to calculate the total required installation depth.
Installation Clearances	See chapter 2

Fig. 24-1 Front view

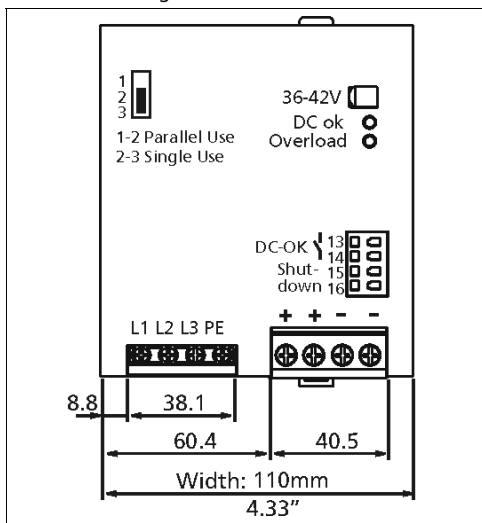
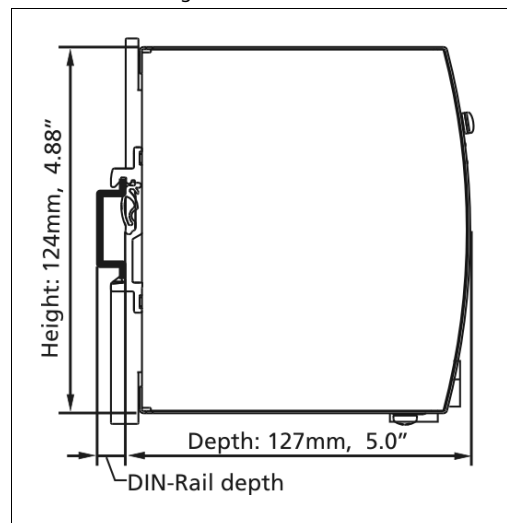

Fig. 24-2 Side view



25. ACCESSORIES

25.1. ZM2.WALL - WALL MOUNTING BRACKET

This bracket is used to mount specific DIMENSION units onto a flat surface without utilizing a DIN-Rail.

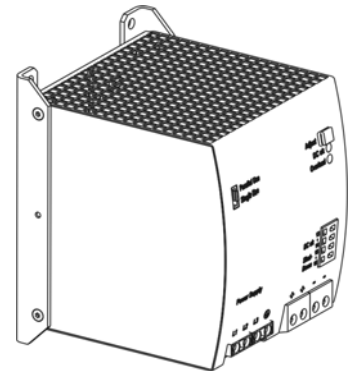
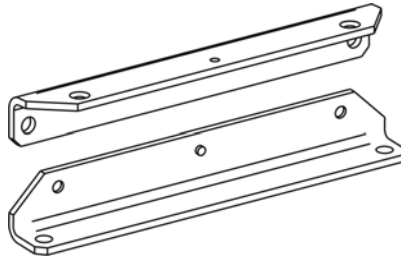

26. APPLICATION NOTES

26.1. REPETITIVE PULSE LOADING

Typically, a load current is not constant and varies over time. This power supply is designed to support loads with a higher short-term power demand (=BonusPower®). The short-term duration is hardware controlled by an output power manager and is available on a repeated basis. If the BonusPower® load lasts longer than the hardware controller allows it, the output voltage will dip and the next BonusPower® is available after the BonusPower® recovery time (see chapter 6) has elapsed.

To avoid this, the following rules must be met:

- The power demand of the pulse must be below 150% of the nominal output power.
- The duration of the pulse power must be shorter than the allowed BonusPower® time. (see output section)
- The average (R.M.S.) output current must be below the specified continuous output current.
If the R.M.S. current is higher, the unit will respond with a thermal shut-down after a period of time. Use the maximum duty cycle curve (Fig. 26-2) to check if the average output current is below the nominal current.
- The duty cycle must be below 0.75.

Fig. 26-1 Repetitive pulse loads, definitions

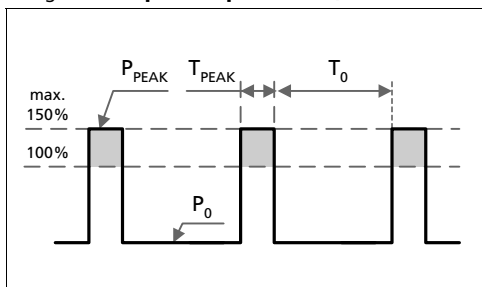

- P₀** Base load (W)
- P_{PEAK}** Pulse load (above 100%)
- T₀** Duration between pulses (s)
- T_{PEAK}** Pulse duration (s)

Fig. 26-2 Max. duty cycle curve

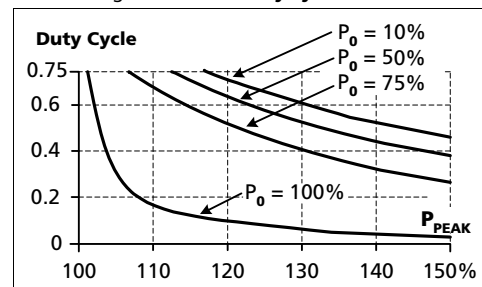

$$\text{DutyCycle} = \frac{T_{\text{peak}}}{T_{\text{peak}} + T_0}$$

$$T_0 = \frac{T_{\text{peak}} - (\text{DutyCycle} \times T_{\text{peak}})}{\text{DutyCycle}}$$

Example: A load is powered continuously with 480W (= 50% of the rated output load). From time to time a peak power of 1440W (= 150% of the rated output load) is needed for 1 second.

The question is: How often can this pulse be supplied without overloading the power supply?

- Make a vertical line at P_{PEAK} = 150% and a horizontal line where the vertical line crosses the P₀ = 50% curve. Read the max. duty cycle from the duty cycle-axis (= 0.37)
- Calculate the required pause (base load) length T₀:
- Result: The required pause length = 1.7s
- Max. repetition rate = pulse +pause length = **2.7s**

$$T_0 = \frac{T_{\text{peak}} - (\text{DutyCycle} \times T_{\text{peak}})}{\text{DutyCycle}} = \frac{1\text{s} - (0.37 \times 1\text{s})}{0.37} = \mathbf{1.7\text{s}}$$

More examples for pulse load compatibility:

P _{PEAK}	P ₀	T _{PEAK}	T ₀	P _{PEAK}	P ₀	T _{PEAK}	T ₀
1440W	960W	1s	>25s	1440W	480W	0.1s	>0.16s
1440W	0W	1s	>1.3s	1440W	480W	1s	>1.6s
1200W	480W	1s	> 0.75s	1440W	480W	3s	>4.9s

26.2. PEAK CURRENT CAPABILITY

The power supply can deliver peak currents (up to several milliseconds) which are higher than the specified short term currents.

This helps to start current demanding loads. Solenoids, contactors and pneumatic modules often have a steady state coil and a pick-up coil. The inrush current demand of the pick-up coil is several times higher than the steady-state current and usually exceeds the nominal output current (including the BonusPower®). The same situation applies when starting a capacitive load.

The peak current capability also ensures the safe operation of subsequent circuit breakers of load circuits. The load branches are often individually protected with circuit breakers or fuses. In case of a short or an overload in one branch circuit, the fuse or circuit breaker need a certain amount of over-current to open in a timely manner. This avoids voltage loss in adjacent circuits.

The extra current (peak current) is supplied by the power converter and the built-in large sized output capacitors of the power supply. The capacitors get discharged during such an event, which causes a voltage dip on the output. The following two examples show typical voltage dips:

Fig. 26-3 Peak load with 2x the nominal current for 50ms, typ.

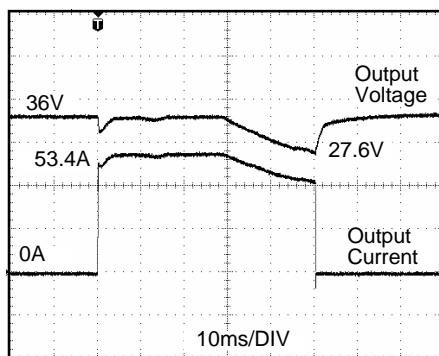

53.4A Peak load (resistive) for 50ms
Output voltage dips from 36V to 27.6V.

Fig. 26-4 Peak load with 5x the nominal current for 5ms, typ.

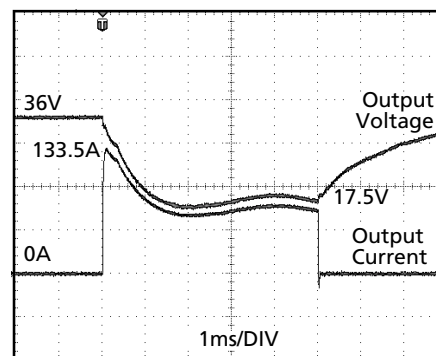

133.5A Peak load (resistive) for 5ms
Output voltage dips from 36V to 17.5V.

Please note: The DC-OK relay triggers when the voltage dips more than 10% for longer than 1ms.

Peak current voltage dips	typ.	from 36V to 27.6V	at 53.4A for 50ms, resistive load
	typ.	from 36V to 17V	at 133.5A for 2ms, resistive load
	typ.	from 36V to 17.5V	at 133.5A for 5ms, resistive load

26.3. EXTERNAL INPUT PROTECTION

The unit is tested and approved for branch circuits up to 30A (U.S.A.) and 32A (IEC). An external protection is only required if the supplying branch has an ampacity greater than this. Check also local codes and local requirements. In some countries local regulations might apply.

If an external fuse is necessary or utilized, minimum requirements need to be considered to avoid nuisance tripping of the circuit breaker. A minimum value of 6A B- or C-Characteristic breaker should be chosen.

26.4. USING ONLY 2 LEGS OF A 3-PHASE SYSTEM

No external protection devices are required to protect against a phase-loss failure.

This power supply can also be permanently operated on two legs of a 3-phase system. However, it is not recommended for this power class since the supplying 3-phase network can become unbalanced.

The output power must be reduced according to the curves below when operation on only two legs of a 3-phase system. A long-term exceeding of these limits will result in a thermal shut-down of the unit.

A use below 340Vac with more than 22A output current can also result in a thermal shut-down.

During power-on, some start-up attempts can occur until a permanent output power is available.

EMC performance, hold-up time, losses and output ripple differ from a three phase operation. Therefore, check suitability of your individual application.

Such use is not included in the UL approval. Additional tests might be necessary when the complete system has to be approved according to UL 508 or UL60950-1.

The screw of the terminal which remains unused must be securely tightened.

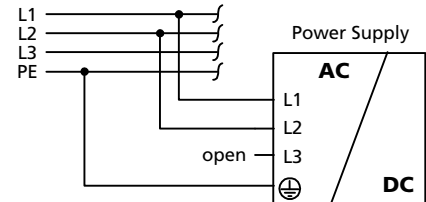

Fig. 26-5

Output current vs. ambient temperature

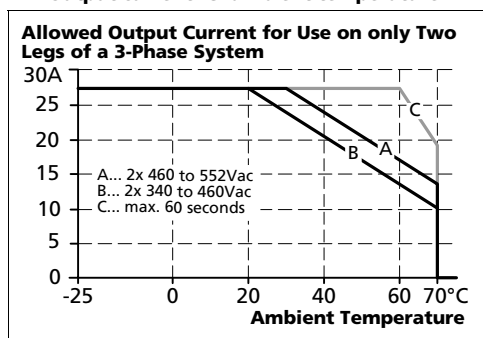

Fig. 26-6

Hold-up time vs. input voltage

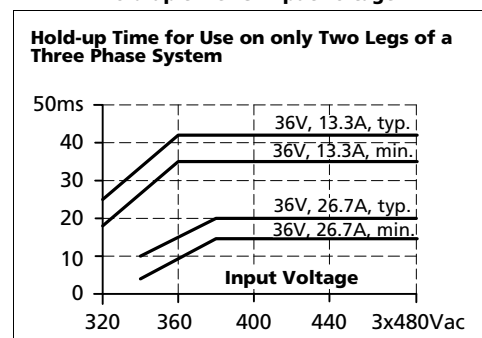

Fig. 26-7

Efficiency vs. output current at 36V

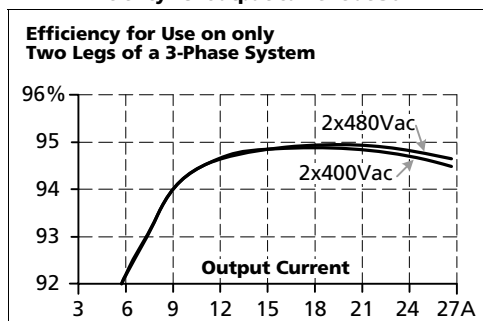
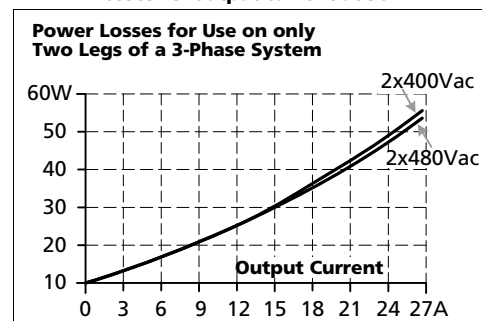

Fig. 26-8

Losses vs. output current at 36V



26.5. CHARGING OF BATTERIES

The power supply can be used to charge lead-acid or maintenance free batteries. (Three 12V batteries in series)

Instructions for charging batteries:

- a) Set output voltage (measured at no load and at the battery end of the cable) very precisely to the end-of-charge voltage.

End-of-charge voltage	41.7V	41.25V	40.8V	40.35V
Battery temperature	10°C	20°C	30°C	40°C

- b) Use a 32A or 40A circuit breaker (or blocking diode) between the power supply and the battery.
- c) Ensure that the output current of the power supply is below the allowed charging current of the battery.
- d) Use only matched batteries when putting 12V types in series.
- e) The return current to the power supply (battery discharge current) is typ. 25mA when the power supply is switched off (except in case a blocking diode is utilized).

26.6. OUTPUT CIRCUIT BREAKERS

Standard miniature circuit breakers (MCB's or UL1077 circuit breakers) are commonly used for AC-supply systems and may also be used on DC branches.

MCB's are designed to protect wires and circuits. If the ampere value and the characteristics of the MCB are adapted to the wire size that is used, the wiring is considered as thermally safe regardless of whether the MCB opens or not.

To avoid voltage dips and under-voltage situations in adjacent 36V branches which are supplied by the same source, a fast (magnetic) tripping of the MCB is desired. A quick shutdown within 10ms is necessary corresponding roughly to the ride-through time of PLC's. This requires power supplies with high current reserves and large output capacitors. Furthermore, the impedance of the faulty branch must be sufficiently small in order for the current to actually flow. The best current reserve in the power supply does not help if Ohm's law does not permit current flow. The following table has typical test results showing which B- and C-Characteristic MCBs magnetically trip depending on the wire cross section and wire length.

Fig. 26-9 Test circuit

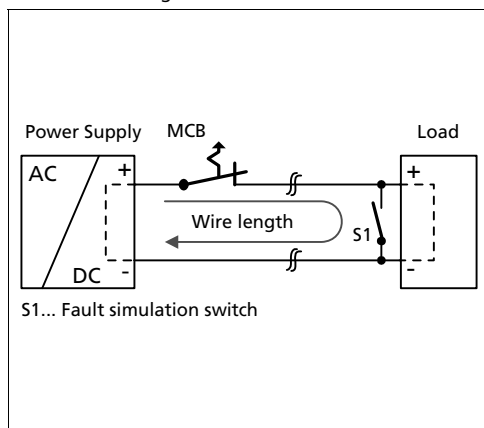

Maximal wire length*) for a fast (magnetic) tripping:

	0.75mm ²	1.0mm ²	1.5mm ²	2.5mm ²
C-2A	51m	63m	101m	143m
C-3A	43m	57m	84m	129m
C-4A	34m	44m	64m	103m
C-6A	15m	21m	32m	49m
C-8A	8m	11m	14m	25m
C-10A	5m	7m	9m	17m
C-13A	2m	3m	4m	8m
B-6A	33m	43m	56m	102m
B-10A	18m	24m	37m	55m
B-13A	9m	19m	30m	47m
B-16A	4m	6m	9m	14m

*) Don't forget to consider twice the distance to the load (or cable length) when calculating the total wire length (+ and - wire).

26.7. PARALLEL USE TO INCREASE OUTPUT POWER

Power supplies from the same series (Q-Series) can be paralleled to increase the output power. The output voltage shall be adjusted to the same value ($\pm 100\text{mV}$) in "Single use" mode with the same load conditions on all units, or the units can be left with the factory settings. After the adjustments, the jumper on the front of the unit shall be moved from "Single use" to "Parallel use", in order to achieve load sharing. The "Parallel use" mode regulates the output voltage in such a manner that the voltage at no load is approx. 4% higher than at nominal load. See also chapter 6. If no jumper is plugged in, the unit is in "Single use" mode. Factory setting is also "Single use" mode.

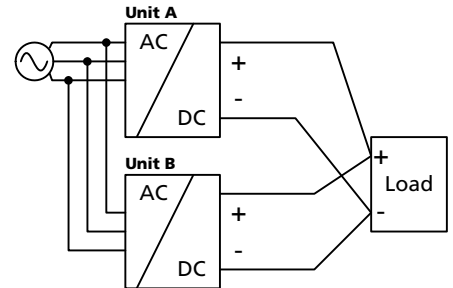

If more than three units are connected in parallel, a fuse or circuit breaker with a rating of 32A or 40A is required on each output. Alternatively, a diode or redundancy module can also be utilized.

Keep an installation clearance of 15mm (left / right) between two power supplies and avoid installing the power supplies on top of each other. Do not use power supplies in parallel in mounting orientations other than the standard mounting orientation (terminals on the bottom of the unit) or in any other condition where a derating of the output current is required (e.g. altitude, above 60°C, ...).

Pay attention that leakage current, EMI, inrush current, harmonics will increase when using multiple power supplies.

26.8. PARALLEL USE FOR REDUNDANCY

Power supplies can be paralleled for redundancy to gain higher system availability. Redundant systems require a certain amount of extra power to support the load in case one power supply unit fails. The simplest way is to put two power supplies in parallel. This is called a 1+1 redundancy. In case one power supply unit fails, the other one is automatically able to support the load current without any interruption. Redundant systems for a higher power demand are usually built in a N+1 method. E.g. five power supplies, each rated for 25A are paralleled to build a 100A redundant system. For N+1 redundancy the same restrictions apply as for increasing the output power, see also chapter 26.7.

Please note: This simple way to build a redundant system does not cover failures such as an internal short circuit in the secondary side of the power supply. In such a case, the defective unit becomes a load for the other power supplies and the output voltage can not be maintained any more. This can be avoided by utilizing decoupling diodes or mosfets.

Recommendations for building redundant power systems:

- Use separate input fuses for each power supply. A separate source for each supply when possible increases the reliability of the redundant system.
- Set the power supply into "Parallel Use" mode.
- Monitor the individual power supply units. Therefore, use the DC-OK relay contact of the QT40 power supply.
- It is desirable to set the output voltages of all units to the same value ($\pm 100\text{mV}$) or leave it at the factory setting.

26.9. SERIES OPERATION

Power supplies of the same type can be connected in series for higher output voltages. It is possible to connect as many units in series as needed, providing the sum of the output voltage does not exceed 150Vdc. Voltages with a potential above 60Vdc are not SELV any more and can be dangerous. Such voltages must be installed with a protection against touching.

Earthing of the output is required when the sum of the output voltage is above 60Vdc.

Avoid return voltage (e.g. from a decelerating motor or battery) which is applied to the output terminals.

Keep an installation clearance of 15mm (left / right) between two power supplies and avoid installing the power supplies on top of each other. Do not use power supplies in series in mounting orientations other than the standard mounting orientation (terminals on the bottom of the unit).

Pay attention that leakage current, EMI, inrush current, harmonics will increase when using multiple power supplies.

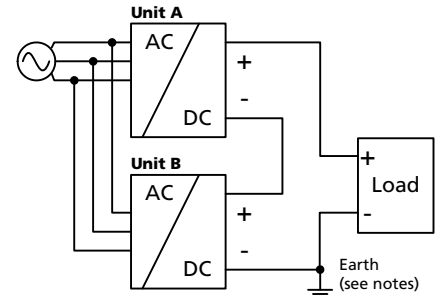

26.10. INDUCTIVE AND CAPACITIVE LOADS

The unit is designed to supply any kind of loads, including capacitive and inductive loads.

26.11. BACK-FEEDING LOADS

Loads such as decelerating motors and inductors can feed voltage back to the power supply. This feature is also called return voltage immunity or resistance against Back- E.M.F. (Electro Magnetic Force).

This power supply is resistant and does not show malfunctioning when a load feeds back voltage to the power supply. It does not matter whether the power supply is on or off.

The maximum allowed feed-back-voltage is 50Vdc. The absorbing energy can be calculated according to the built-in large sized output capacitor which is specified in chapter 6.

26.12. USE IN A TIGHTLY SEALED ENCLOSURE

When the power supply is installed in a tightly sealed enclosure, the temperature inside the enclosure will be higher than outside. In such situations, the inside temperature defines the ambient temperature for the power supply.

The following measurement results can be used as a reference to estimate the temperature rise inside the enclosure.

The power supply is placed in the middle of the box, no other heat producing items are inside the box

Enclosure:	Rittal Typ IP66 Box PK 9522 100, plastic, 254x180x165mm
Load:	36V, 21.4A; (=80%) load is placed outside the box
Input:	230Vac
Temperature inside enclosure:	50.2°C (in the middle of the right side of the power supply with a distance of 2cm)
Temperature outside enclosure:	21.2°C
Temperature rise:	29.0K

26.13. MOUNTING ORIENTATIONS

Mounting orientations other than all terminals on the bottom require a reduction in continuous output power or a limitation in the maximum allowed ambient temperature. The amount of reduction influences the lifetime expectancy of the power supply. Therefore, two different derating curves for continuous operation can be found below:

Curve A1

Recommended output current.

Curve A2

Max allowed output current (results in approximately half the lifetime expectancy of A1).

Fig. 26-10
Mounting Orientation A
(Standard orientation)

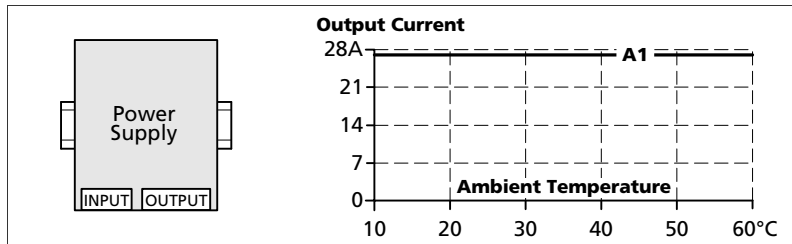

Fig. 26-11
Mounting Orientation B
(Upside down)

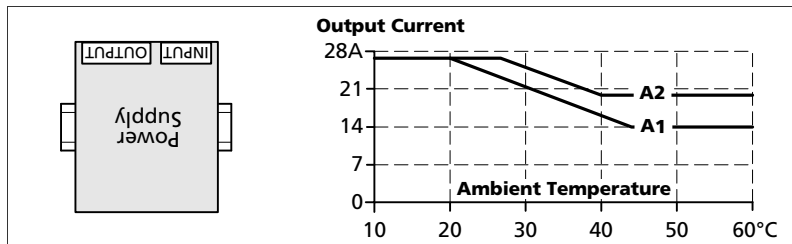

Fig. 26-12
Mounting Orientation C
(Table-top mounting)

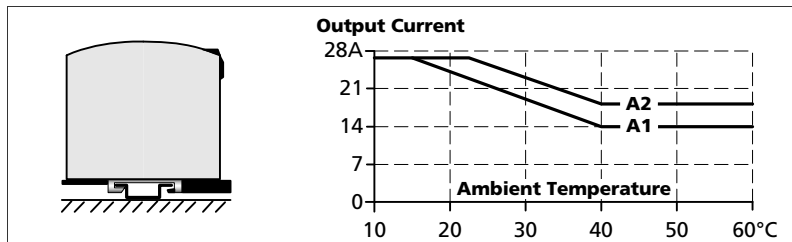

Fig. 26-13
Mounting Orientation D
(Horizontal cw)

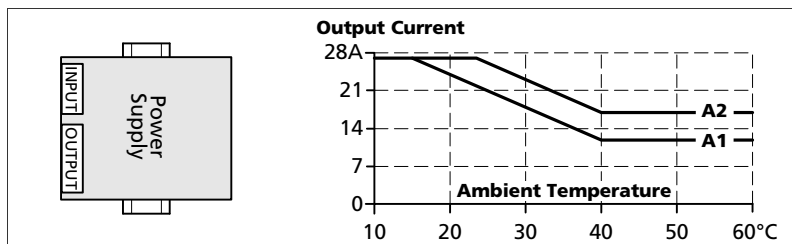

Fig. 26-14
Mounting Orientation E
(Horizontal ccw)

