



SEW
EURODRIVE



MOVITRAC[®] B

Edition 05/2009

16810813 / EN

Operating Instructions





Contents

1	Important Information	5
1.1	How to use the operating instructions	5
1.2	Structure of the safety notes	6
1.3	Rights to claim under warranty	6
1.4	Exclusion of liability	6
2	Safety Notes	7
2.1	Preliminary information	7
2.2	General	7
2.3	Target group	8
2.4	Designated use	8
2.5	Other applicable documentation	9
2.6	Transport	9
2.7	Extended storage	9
2.8	Installation/assembly	9
2.9	Electrical connection	10
2.10	Safe disconnection	10
2.11	Startup/operation	10
3	Unit Design	11
3.1	Sizes 0XS / 0S / 0L	11
3.2	Sizes 1 / 2S / 2	12
3.3	Size 3	13
3.4	Sizes 4 / 5	14
3.5	Unit designation / nameplate	15
4	Installation	16
4.1	Recommended tools	16
4.2	Installation notes	16
4.3	Installing optional power components	21
4.4	UL compliant installation	26
4.5	Installation of loose items	28
4.6	Requirements for installing cold plate (size 0 only)	33
4.7	Deactivating EMC capacitors (size 0 only)	33
4.8	Wiring diagram	35
4.9	TF thermistor and TH bimetallic switch	36
4.10	Connecting braking resistor BW..-P / BW..-T / BW.. to X3 / X2	36
4.11	Connecting brake rectifiers	37
4.12	Installing FSC11B / FIO11B / FIO21B	38
4.13	Installing the MBG11A speed control module	43



5	Startup	44
5.1	Brief description of the startup process.....	44
5.2	General startup instructions.....	45
5.3	Preliminary work and resources.....	46
5.4	Optional keypad FBG11B.....	47
5.5	Basic operation of the FBG11B keypad.....	48
5.6	Manual operation with FBG11B speed control module.....	50
5.7	External setpoint selection.....	51
5.8	Startup using the FBG11B keypad.....	52
5.9	Startup with PC and MOVITOOLS® MotionStudio.....	55
5.10	Startup of explosion-proof AC asynchronous motors of category 2 (94/9/EC).....	56
5.11	Starting the motor.....	57
5.12	Parameter list.....	61
6	Operation	72
6.1	Data backup.....	72
6.2	Return codes (r-19 – r-38).....	73
6.3	Status displays.....	74
6.4	Unit status codes.....	75
7	Service / List of Faults	76
7.1	Unit information.....	76
7.2	List of faults (F-00 – F-113).....	78
7.3	SEW electronics service.....	81
7.4	Extended storage.....	82
8	Technical Data	83
8.1	CE marking, UL approval and C-Tick.....	83
8.2	General technical data.....	84
8.3	MOVITRAC® B electronics data.....	86
8.4	Technical data of MOVITRAC® B.....	88
8.5	Front option FBG11B keypad.....	107
8.6	FSC11B communication module.....	108
8.7	FIO11B analog module.....	109
8.8	FIO21B digital module.....	110
	Index	111



1 Important Information

1.1 How to use the operating instructions

The operating instructions are an integral part of the product and contain important information for operation and service. The operating instructions are written for all employees who assemble, install, startup, and service this product.

The operating instructions must be legible and accessible at all times. Make sure that staff responsible for the plant and its operation, as well as persons who work independently on the unit, have read the operating instructions carefully and understood them. If you are unclear about any of the information in this documentation, or if you require further information, contact SEW-EURODRIVE.

1.1.1 Text Conventions

- Texts in software user interfaces (menu items, buttons, etc.) in square brackets, e.g.: "Click the [Start] button."
- Parameter names are written in italics, e.g.: "Write down the values of variables *H509* *ACT.POS.ABS*."
- The display of the FBG11B keypad is indicated by a font with fixed character width, e.g.: "The display shows `stop`."



Important Information

Structure of the safety notes

1.2 Structure of the safety notes

The safety notes in these operating instructions are designed as follows:

Pictogram 	SIGNAL WORD
	Type and source of danger. Possible consequence(s) if the safety notes are disregarded. • Measure(s) to prevent the danger.

Pictogram	Signal word	Meaning	Consequences if disregarded
Example: General danger	DANGER	Imminent danger	Severe or fatal injuries
	WARNING	Possible dangerous situation	Severe or fatal injuries
	CAUTION	Possible dangerous situation	Minor injuries
 Specific danger, such as electric shock	NOTICE	Possible damage to property	Damage to the drive system or its environment
	TIP	Useful information or tip. Simplifies the handling of the drive system.	

1.3 Rights to claim under warranty

A requirement of fault-free operation and fulfillment of any rights to claim under limited warranty is that you adhere to the information in the operating instructions. Therefore, read the operating instructions before you start working with the unit.

1.4 Exclusion of liability

You must comply with the information contained in these operating instructions to ensure safe operation of MOVITRAC® B frequency inverters and to achieve the specified product characteristics and performance requirements. SEW-EURODRIVE does not assume liability for injury to persons or damage to equipment or property resulting from non-observance of these operating instructions. In such cases, any liability for defects is excluded.



2 Safety Notes

The following basic safety notes must be read carefully to prevent injury to persons and damage to property. The operator must ensure that the basic safety notes are read and observed. Make sure that persons responsible for the plant and its operation, as well as persons who work independently on the unit, have read through the operating instructions carefully and understood them. If you are unclear about any of the information in this documentation, or if you require further information, please contact SEW-EURODRIVE.

2.1 Preliminary information

The following safety notes predominantly refer to the use of frequency inverters. Additionally, when using drives with motors or gearmotors, observe the corresponding safety notes in the respective operating instructions.

Also observe the supplementary safety notes in the individual sections of this publication.

2.2 General

	DANGER
	<p>During operation, frequency inverters can have live, bare parts according to their degree of protection.</p> <p>Severe or fatal injuries.</p> <ul style="list-style-type: none"> • All work related to transportation, storage, setup/mounting, connection, startup, maintenance and repair may only be carried out by qualified personnel, in strict observation of: <ul style="list-style-type: none"> – The relevant detailed operating instructions – The warning and safety signs on the motor/gearmotor – All other project planning documents, operating instructions and wiring diagrams related to the drive – The specific regulations and requirements for the system – The national/regional regulations governing safety and the prevention of accidents • Never install damaged products. • Immediately report any damages to the shipping company.

Removing covers without authorization, improper use as well as incorrect installation or operation may result in severe injuries to persons or damage to property.

This document includes further information.



2.3 Target group

Any mechanical work may only be performed by adequately qualified personnel. Qualified personnel in this context are persons who are familiar with the setup, mechanical installation, trouble shooting and maintenance for this product. Further, they are qualified as follows:

- Training in mechanical engineering, e.g. as a mechanic or mechatronics technician (final examinations must have been passed).
- They are familiar with these operating instructions.

Any electronic work may only be performed by adequately qualified electricians. Qualified electricians in this context are persons who are familiar with the electronic installation, startup, trouble shooting and maintenance for this product. Further, they are qualified as follows:

- Training in electrical engineering, e.g. as an electrician or mechatronics technician (final examinations must have been passed).
- They are familiar with these operating instructions.

All work in further areas of transportation, storage, operation and waste disposal may be carried out only by persons who are trained appropriately.

2.4 Designated use

Frequency inverters are components for controlling asynchronous AC motors. Frequency inverters are components intended for installation in electrical systems or machines. Never connect capacitive loads. Operation with capacitive loads results in over voltages and may destroy the unit.

The following standards apply, if the frequency inverters are marketed in the EU/EFTA:

- In case of installation in machines, startup of the drive inverters (meaning the start of proper use) is prohibited until it is determined that the machine meets the requirements stipulated in the EC Directive 98/37/EC (machine directive); observe EN 60204.
- Startup (i.e. the start of designated use) is only permitted under observance of the EMC (2004/108/EC) directive.
- The frequency inverters comply with the requirements of the Low Voltage Directive 2006/95/EC. The harmonized standards of the EN 61800-5-1/DIN VDE T105 series in connection with EN 60439-1/VDE 0660 part 500 and EN 60146/VDE 0558 are applied to these frequency inverters.

Observe the technical data and the connection requirements specified on the nameplate and the operating instructions.

2.4.1 Safety functions

Frequency inverters from SEW-EURODRIVE must not perform any safety functions unless the inverters are subordinate to other safety systems.

Use higher-level safety systems to ensure protection of equipment and personnel.



2.5 Other applicable documentation

When using the "Safe stop" function, you must observe the following publications:

- MOVITRAC® B / Safe Disconnection – Conditions
- MOVITRAC® B / Safe Disconnection – Applications

These publications are available via **Documentation\Software\CAD** on the SEW-EURODRIVE homepage.

2.6 Transport

Immediately upon receipt, inspect the shipment for any damage that may have occurred during transportation. Inform the shipping company immediately in the event of damage. It may be necessary to preclude startup. Observe the climate conditions according to chapter "General technical data".

2.7 Extended storage

Observe the notes in section "Extended storage".

2.8 Installation/assembly

The units must be installed and cooled according to the regulations and specifications in this documentation.

Protect the frequency inverters from excessive strain. Do not twist any components and do not modify the insulation spaces. Do not touch any electronic components or contacts.

Frequency inverters contain components that can easily be damaged by electrostatic energy and improper handling. Electric components must not be mechanically damaged or destroyed.

The following applications are prohibited unless the unit is explicitly designed for such use:

- Use in potentially explosive atmospheres.
- Use in areas exposed to harmful oils, acids, gases, vapors, dust, radiation, etc. (frequency inverter may only be operated in climate class 3K3 to EN 60721-3-3)
- Use in non-stationary applications which are subject to mechanical vibration and impact loads in excess of the requirements in EN 61800-5-1.



2.9 Electrical connection

Observe the applicable national accident prevention guidelines when working on live frequency inverters (e.g. BGV A3 for Germany).

During installation, observe the specifications regarding cable cross sections, fusing and protective conductor connection. This publication contains additional information.

In this documentation, you will find notes on EMC compliant installation, such as shielding, grounding, arrangement of filters and routing of lines. The manufacturer of the system or machine is responsible for maintaining the limits established by EMC legislation.

Protective measures and protection devices must comply with the regulations in force (e.g. EN 60204 or EN 61800-5-1).

Ground the unit.

2.10 Safe disconnection

The unit meets all requirements for safe disconnection of power and electronic connections in accordance with EN 61800-5-1. All connected circuits must also satisfy the requirements for safe disconnection.

2.11 Startup/operation

Systems with integrated frequency inverters must be equipped with additional monitoring and protection devices, as applicable, according to the relevant safety guidelines and regulations, such as legislation governing technical equipment, accident prevention regulations, etc.

Do not touch live components or power connections until 10 minutes after disconnecting the frequency inverters from the supply voltage because there may still be some charged capacitors. Observe the corresponding labels on the frequency inverter.

Keep all covers and doors closed during operation.

The fact that the status LED and other display elements are no longer illuminated does not indicate that the unit has been disconnected from the mains and no longer carries any voltage.

Mechanical blocking or safety functions inside the unit may result in the motor coming to a standstill. Eliminating the cause of the problem or performing a reset may result in the drive re-starting automatically. If, for safety reasons, this is not permitted for the driven machine, disconnect the unit from the supply system before correcting the error.

kVA	n
	f
i	
P	Hz

3 Unit Design

3.1 Sizes 0XS / 0S / 0L

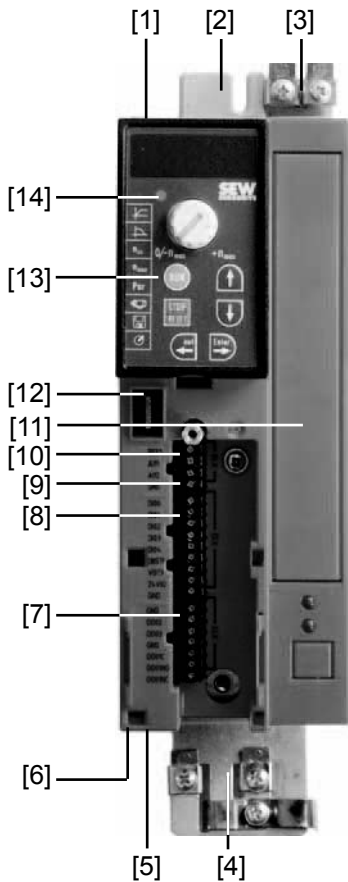

- [1] X1: Power supply connection:
 3-phase: L1 / L2 / L3
 1-phase: L / N
- [2] Fixing strap
- [3] PE connection
- [4] Shield plate for motor cable, fixing strap underneath
- [5] X2: Motor connection U / V / W / Brake connection +R / -R
- [6] X17: Safety contact for safe stop (only MC07B...-S0: sizes 0S / 0L, 400 / 500 V)
- [7] X13: Binary outputs
- [8] X12: Binary inputs
- [9] X10: Analog input
- [10] Switch S11 for V-mA toggle analog input
 (in sizes 0XS and 0S behind removable connector)
- [11] Option card slot (cannot be retrofitted / not for BG0XS)
- [12] Connection for optional communication / analog module
- [13] Optional keypad, inserted
- [14] Status LED (visible without optional keypad)

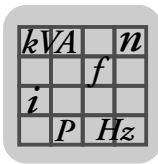

3.2 Sizes 1 / 2S / 2

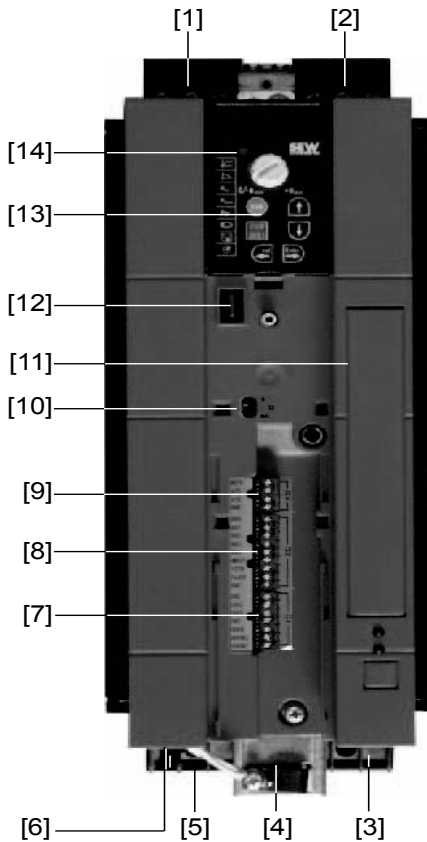

- [1] X1: Power supply connection 3-phase: L1 / L2 / L3 / PE screw
- [2] X4: DC link connection $-U_z / +U_z$
- [3] X3: Braking resistor connection R+ / R- / PE
- [4] Electronics shield clamp
- [5] X2: Motor connection U / V / W / PE screw
- [6] X17: Safety contact for safe stop (only 400 / 500 V)
- [7] X13: Binary outputs
- [8] X12: Binary inputs
- [9] X10: Analog input
- [10] Switch S11 for V-mA toggle analog input
- [11] Option card slot
- [12] Connection for optional communication / analog module
- [13] Optional keypad, inserted
- [14] Status LED (visible without optional keypad)

kVA	n
	f
i	
P	Hz

3.3 Size 3

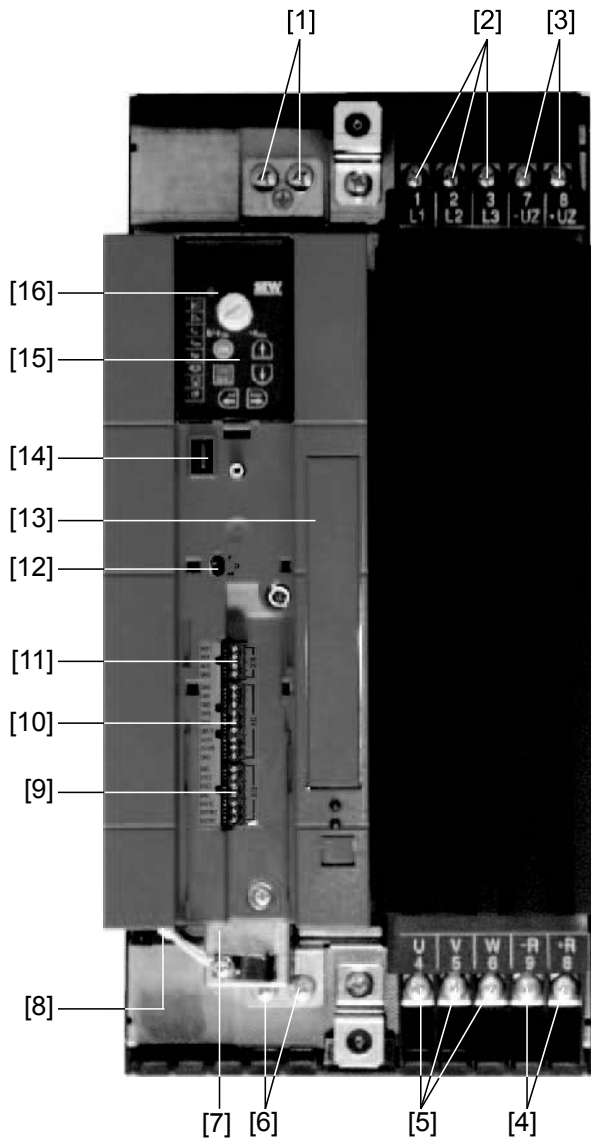

- [1] X2: PE connection
- [2] X1: Power supply connection 3-phase: 1/L1 / 2/L2 / 3/L3
- [3] X4: DC link connection $-U_Z$ / $+U_Z$
- [4] X3: Braking resistor connection R+ (8) / R- (9) and PE connection
- [5] X2: Motor connection U (4) / V (5) / W (6)
- [6] X2: PE connection
- [7] Electronics shield clamp
- [8] X17: Safety contact for safe stop (only 400 / 500 V)
- [9] X13: Binary outputs
- [10] X12: Binary inputs
- [11] X10: Analog input
- [12] Switch S11 for V-mA toggle analog input
- [13] Option card slot
- [14] Connection for optional communication / analog module
- [15] Optional keypad, inserted
- [16] Status LED (visible without optional keypad)

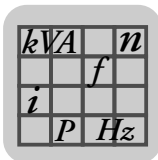

3.4 Sizes 4 / 5

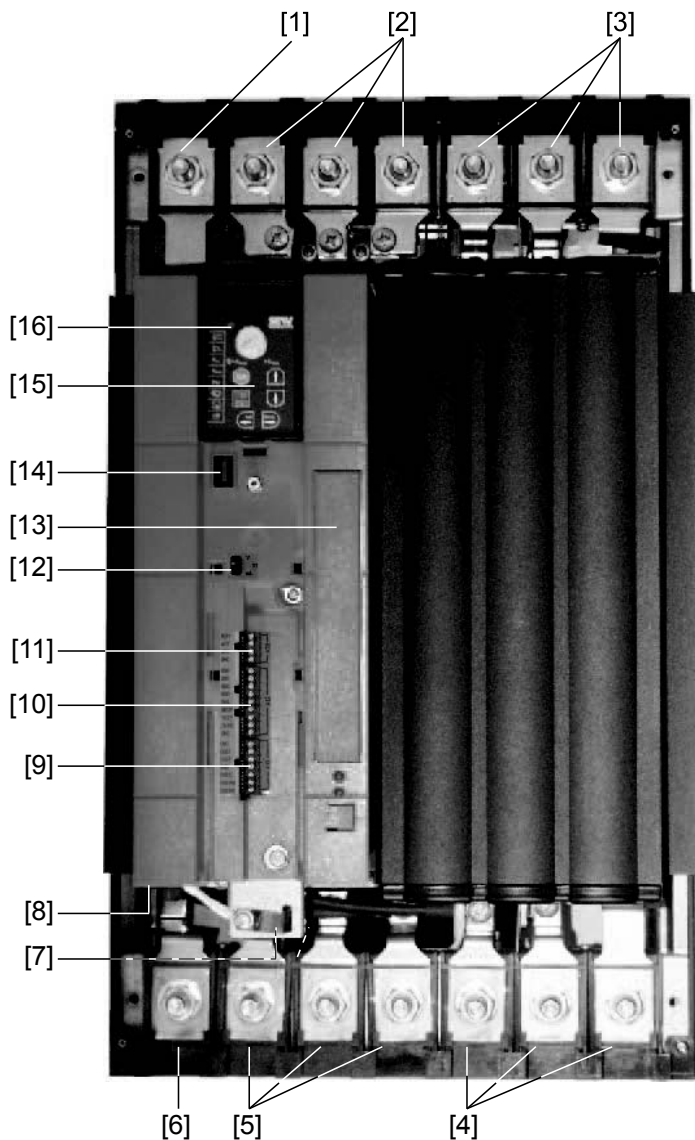

- [1] X2: PE connection
- [2] X1: Power supply connection 3-phase: 1/L1 / 2/L2 / 3/L3
- [3] X4: DC link connection $-U_z$ / $+U_z$ and PE connection
- [4] X3: Braking resistor connection R+ (8) / R- (9) and PE connection
- [5] X2: Motor connection U (4) / V (5) / W (6)
- [6] X2: PE connection
- [7] Electronics shield clamp
- [8] X17: Safety contact for safe stop (only 400 / 500 V)
- [9] X13: Binary outputs
- [10] X12: Binary inputs
- [11] X10: Analog input
- [12] Switch S11 for V-mA toggle analog input
- [13] Option card slot
- [14] Connection for optional communication / analog module
- [15] Optional keypad, inserted
- [16] Status LED (visible without optional keypad)

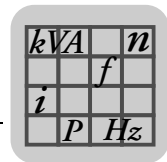

3.5 Unit designation / nameplate

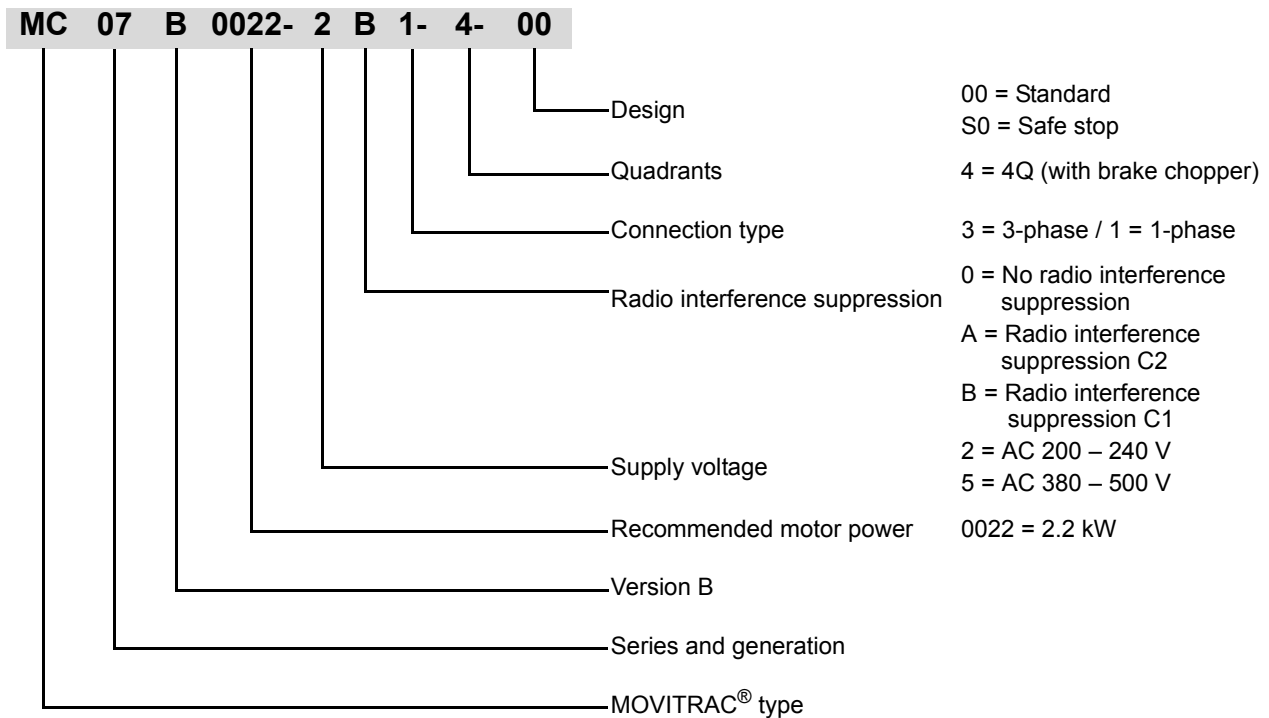

SEW EURODRIVE
D-76646 Bruchsal
Made in Germany

MOVITRAC-B
Umrichter
Inverter

Type: MC07B0022-2B1-4-00 / FSC11B / DFE24B
P#: 08284989 S0#: 01.8508099801.0001.06

Eingang / Input	Ausgang / Output
U = 1x200...240V AC	U = 3x0...UN
I = 19.7A AC (230V)	I = 8.6A AC
f = 50...60Hz	f = 0...600Hz

T = -10...+50°C P Motor = 2.2kW/3.0HP IP20

Freitextzeile mit zur Zeit max. 51 Zeichen

12 10 13 -- -- ML0001

CE, UL, PG, CH01

MC07B0022-2B1-4-00

Input	U	Rated mains voltage
	I	Rated mains current, 100 % operation
	f	Rated mains frequency
Output	U	Output voltage 100 % operation
	I	Rated output current 100 % operation
	f	Output frequency
T		Ambient temperature
P motor		Recommended motor power 100 % operation

The unit status for communication with SEW-EURODRIVE is indicated over the bar code at the bottom. The unit status documents the hardware and software states of the unit.

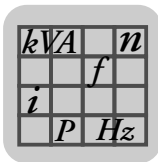

4 Installation

4.1 Recommended tools

- Use a screwdriver with a 2.5 mm wide blade for connecting the electronics terminal strip X10 / X12 / X13.

4.2 Installation notes

4.2.1 Mounting the front options

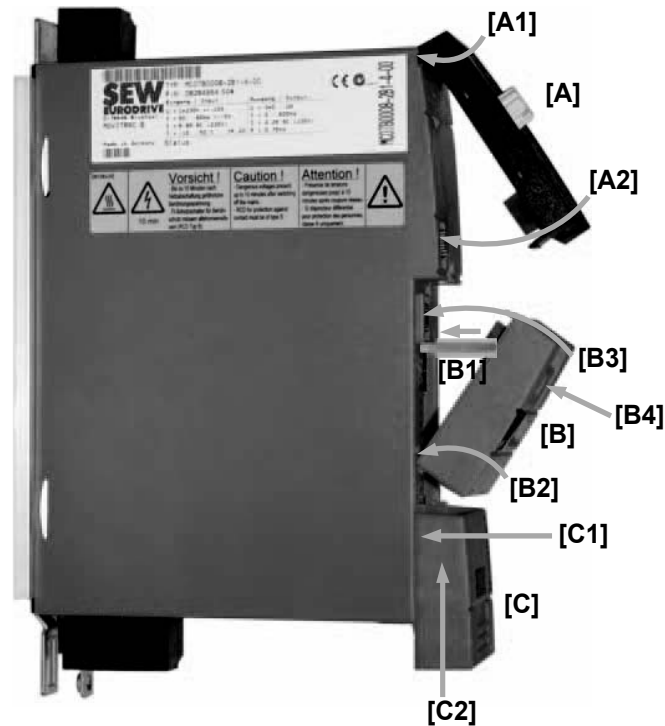

Attach the front options as follows:

- Inserting the FBG11A [A] keypad:
 1. Insert the FBG11B keypad [A] on top of the housing [A1].
 2. Press the socket on the keypad onto the connector in the unit [A2].
- Inserting the FSC11B communication module or the FIO11B analog module [B]:
 1. For size 0, mount the spacer bolt [B1] when using the FSC11B communication module or FIO11B analog module [B].
 2. Insert the FSC11B communication module and the FIO11B analog module [B] at the bottom of the housing [B2].
 3. Press the socket on the front option onto the connector in the unit [B3].
 4. Secure the front option using the screw on the unit [B4].
- Mounting the cover [C]:
 1. Position the cover [C] on the unit approximately 5 mm away from its final position [C1].
 2. Move the cover upwards [C2].

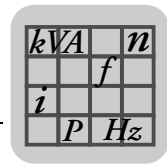

4.2.2 Minimum clearance and mounting position

- Leave 100 mm (3.94 in) clearance at the top and bottom of the housing for optimum cooling. There is no need for clearance at the sides. You can line up the units directly next to one another.
- It is important that air circulation is not impeded by cables and other installation material. Prevent the heated exhaust air from other units from blowing onto this unit.
- Install the units vertically only. You must not install them horizontally, tilted or upside down.
- Proper heat dissipation of the rear side of the heat sink improves the thermal utilization of the unit.

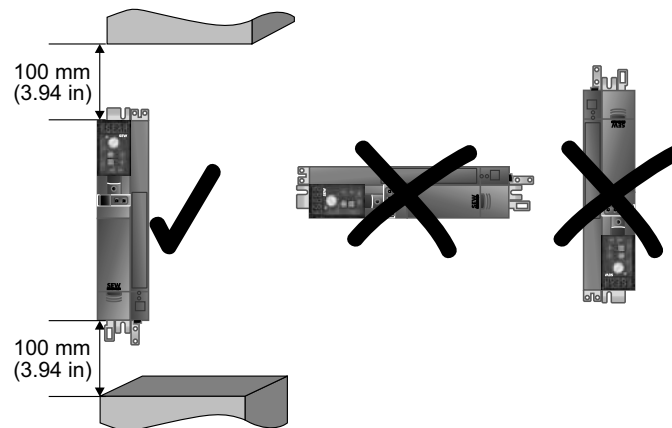

4.2.3 Separate cable ducts

- Route power cables and electronics cables in separate cable ducts.

4.2.4 EMC-compliant installation

- Shield all cables except for the power supply cable. For the motor cable, you can use the HD.. option (output choke) instead of the shielding to meet the interference emission limit values .
- When using shielded motor cables, e.g. prefabricated motor cables from SEW-EURODRIVE, you must keep the unshielded conductors between the shield and connection terminal of the inverter as short as possible.
- Connect the shield by the shortest possible route and make sure it is grounded over a wide area at both ends. If using double-shielded cables, ground the outer shield on the inverter end and the inner shield at the other end.

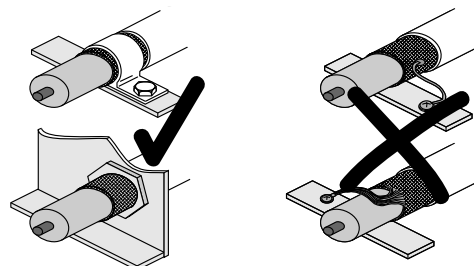

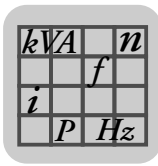

- You can also use earthed sheet-metal ducts or metal pipes to shield the cables. Install the power and control cables separately.
- Provide high frequency compatible grounding for the inverter and all additional units (wide area metal-on-metal contact between the unit housing and ground, e.g. unpainted control cabinet mounting panel).

4.2.5 Operation on IT systems

- SEW recommends using earth-leakage monitors with a pulse code measuring process in voltage supply systems with a non-earthed star point (IT systems). Use of such devices prevents the earth-leakage monitor mis-tripping due to the earth capacitance of the inverter.
- For size 0, SEW recommends deactivating the interference suppressor filter using the enclosed insulation discs (see Deactivating EMC capacitors (size 0 only)).

4.2.6 Utilization category of contactors

- Use only contactors in utilization category AC-3 (EN 60947-4-1).

4.2.7 Required cross sections

- Power supply cable: Cross section according to rated input current I_{mains} at rated load
 Motor lead: Cross section according to rated output current I_N
 Electronics cables: Maximum 1.5 mm² (AWG16) without conductor end sleeves¹⁾
 Maximum 1.0 mm² (AWG17) with conductor end sleeves

4.2.8 Cable lengths for individual drives

- The cable lengths depend on the PWM frequency. The permitted motor cable lengths are listed in the "Project Planning" section of the MOVITRAC[®] B system manual.

4.2.9 Unit output

- Only connect an ohmic/inductive load (motor); do not connect a capacitive load!

4.2.10 Braking resistor connection

- Shorten the cables to the required length.
- Use 2 tightly twisted leads or a 2-core shielded power cable. Cross-section according to the rated output current of the inverter.
- Protect the braking resistor with a bimetallic relay with trip class 10 or 10A (wiring diagram). Set the trip current according to the technical data of the braking resistor.

1) Do not install fine wired cables without conductor end sleeves.

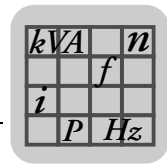

- For braking resistors in the BW..-T series, you can connect the integrated thermostat using a 2-core, shielded cable as an alternative to a bimetallic relay.
- The flat-type braking resistors have internal thermal overload protection (fuse cannot be replaced). Install the flat-design braking resistors together with the appropriate touch guard.

4.2.11 Installing the braking resistor

- The supply cables to the braking resistors carry a high voltage (approx. DC 900 V) during rated operation.
- The surfaces of the braking resistors get very hot when the braking resistors are loaded with P_{rated} . Choose a suitable installation location. Braking resistors are usually mounted on the control cabinet roof.

4.2.12 Binary outputs

- The binary outputs are short-circuit proof and protected against external voltage to 30 V. Higher external voltages can destroy the binary outputs.

4.2.13 Interference emission

- Use shielded motor cables or HD output chokes for EMC compliant installation.

4.2.14 Switched inductances



NOTICE
Switched inductances
Hazard: Malfunctions / damage to property.
Measure: The minimum distance of switched inductances to the inverter must be at least 150 mm (5.91 in).

- Use suppressors to suppress interference on
 - Contactors
 - Relays
 - Solenoid valves

Suppressors are, for example, diodes, varistors, or RC elements:

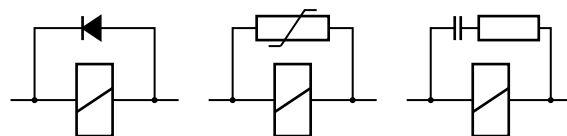

Do not connect any suppressors directly on MOVITRAC® B. Connect suppressors as closely as possible to the inductance.

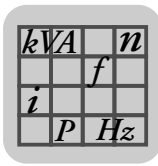

4.2.15 Line filters

MOVITRAC® B frequency inverters have an integrated line filter as standard. They comply with the following limit value class to EN 55011 on the line side without further measures:

- Single-phase connection: C1 cable conducted
- Three-phase connection: C2

No EMC limits are specified for interference emission in voltage supply systems without an earthed star point (IT system). The efficiency of line filters is severely limited.

4.2.16 Line protection and earth-leakage circuit breaker

- Install fuses at the beginning of the mains cable behind supply bus junction (see basic unit wiring diagram).
- SEW-EURODRIVE recommends that you do not use earth-leakage circuit breakers. However, if an earth-leakage circuit breaker is stipulated for direct or indirect protection against contact, observe the following:

	TIP
	<p>Use only type B earth-leakage circuit breakers.</p> <p>MOVITRAC® can cause direct current in the protective earth. In cases where an earth-leakage circuit breaker is used for protection against direct or indirect contact, only install a type B earth-leakage circuit breaker on the power supply end of the MOVITRAC® unit.</p>

4.2.17 PE input connection

Earth-leakage currents ≥ 3.5 mA may occur during normal operation. Observe the following for reliable PE connection:

- Power supply cable $< 10 \text{ mm}^2$ (AWG7):
 - Route a second PE conductor with the same cross section as the power supply cable in parallel to the protective earth via separate terminals, or
 - Use a copper protective earth conductor with a cross section of 10 mm^2 (AWG7)
- Power supply cable $10 \text{ mm}^2 - 16 \text{ mm}^2$ (AWG7 – AWG5):
 - Copper protective earth conductor with the cross section of the power supply cable.
- Power supply cable $16 \text{ mm}^2 - 35 \text{ mm}^2$ (AWG5 – AWG2):
 - Copper protective earth conductor with a cross section of 16 mm^2 (AWG5)
- Power supply cable $> 35 \text{ mm}^2$ (AWG2):
 - Copper protective earth conductor with half the cross section of the power supply cable.

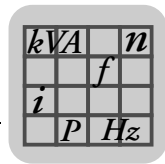

4.3 Installing optional power components

Input contactor for several units

Connect a line choke for limiting the inrush current:

- For 5 or more 3-phase units
- For 2 or more 1-phase units

4.3.1 ND line choke

Connecting ND series line choke

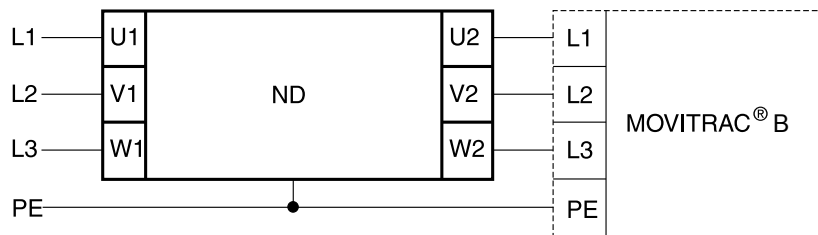

4.3.2 NF line filter

- Using the NF line filter, you can maintain limit value class C1 / B with MOVITRAC® B sizes 0 to 4.



NOTICE

Possible damage to property

No switching is permitted between the line filter and MOVITRAC®.

- Consequences if disregarded: Damage to the input stage.

- Install the line filter close to the inverter but outside the minimum clearance for cooling.
- Restrict the cable between the line filter and the inverter to the absolute minimum length required, and never more than 400 mm (15.7 in). Unshielded, twisted cables are sufficient.
- Use also unshielded lines for the power supply cable.

Connecting NF line filters

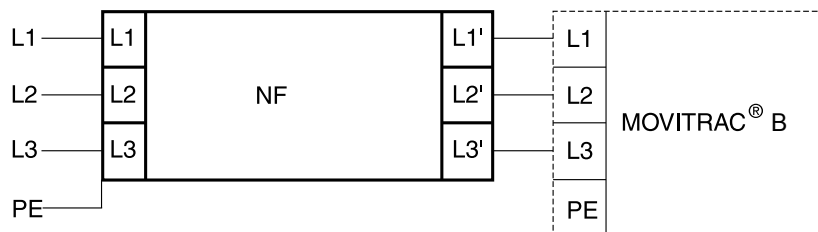

4.3.3 ULF11A folding ferrites

Place the supply system cable (L and N) in the folding ferrite and press the folding ferrites together until they snap in place.

Compliance with EMC limit class C1 has been tested on a specified test setup. Compliance with class C1 for signal interference is achieved by the proper installation of ULF11A folding ferrites.

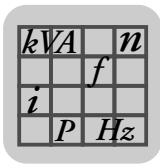

4.3.4 HF output filters

i	TIP
	<ul style="list-style-type: none"> Install output filters next to the corresponding inverter. Leave a ventilation space of at least 100 mm (3.94 in) below and above the output filter. No clearance is required on the sides.

- Limit the length of the cable between inverter and output filter to the absolute minimum needed. Maximum 1 m / 3 ft with unshielded cable, 10 m / 33 ft with shielded cable.
- Several motors can be connected to one output filter when operating a motor group from one inverter. The total value of the rated motor currents must not exceed the rated throughput current of the output filter.
- Two identical output filters can be connected in parallel to one inverter output to double the rated throughput current. To do this, connect all like connections to the output filters in parallel.
- If you operate the inverter with $f_{PWM} = 4$ or 8 kHz, do not connect the output filter connection V5 (with HF..-503) or 7 (with HF..-403).
- No V_{DC} link connection is permitted for size 0XS units.

HF output filter connection without V_{DC} link connection (PWM frequency only 4 or 8 kHz)

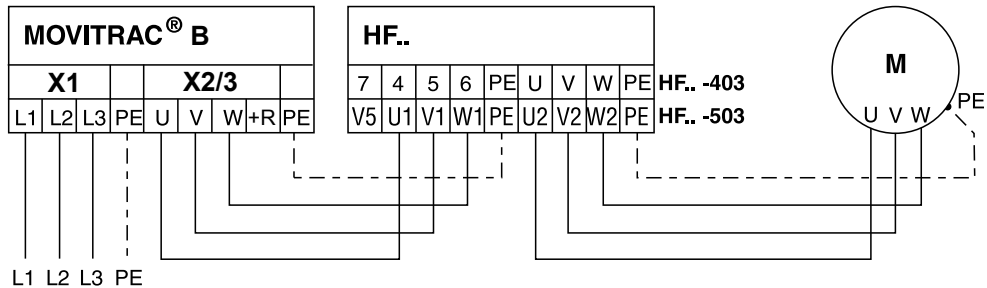

HF output filter connection without V_{DC} link connection (PWM frequency only 12 or 16 kHz)

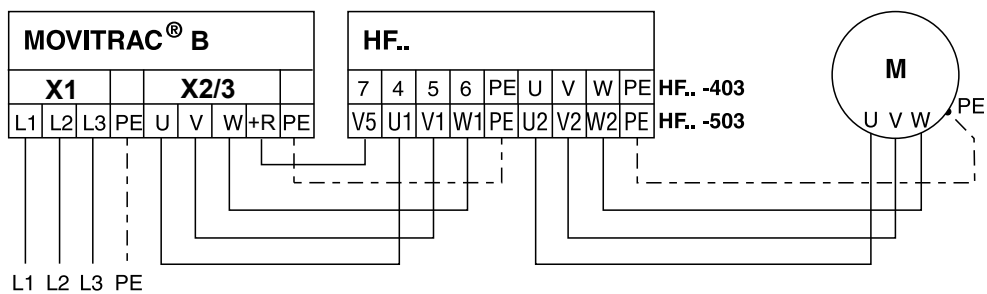

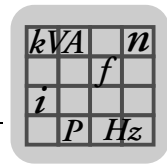

4.3.5 HD output choke

- Install the output choke close to MOVITRAC® B beyond the minimum clearance.
- Always route all 3 phases (not PE!) through the output choke.
- If the cable is shielded, the shield should not be routed through the output choke.

When using the HD output choke, you have to wrap the cable around the choke 5 times.

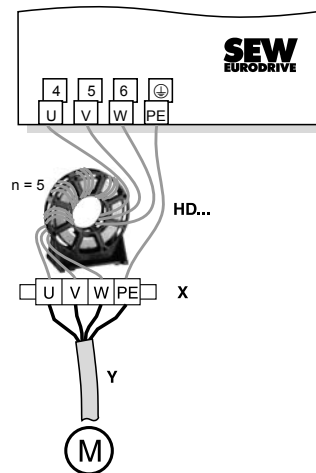

Only 5 loops are possible if the cable has a large diameter. To make up for this, 2 or 3 output chokes should be connected in series. SEW recommends connecting in series 2 output chokes in case of 4 windings and 3 output chokes in case of 3 windings.

- Installing HD012 output choke:

Install the output choke under the associated inverter. Leave a ventilation space of at least 100 mm (3.94 in) below and above the output choke. Provide a clearance of 10 mm (0.39 in) on each side.

Three alternative connection options are provided for connecting the protective earth. You can connect the PE line of the motor cable directly on the frequency inverter.

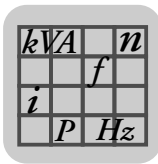

Installation

Installing optional power components

Installing output choke HD100 / HD101

Use the supplied screws to mount the HD100 / HD101 output choke together with the MOVITRAC B frequency inverter onto the conductive mounting surface in the control cabinet.

The connections U / V / W are labeled U / V / W and have to be connected accordingly.

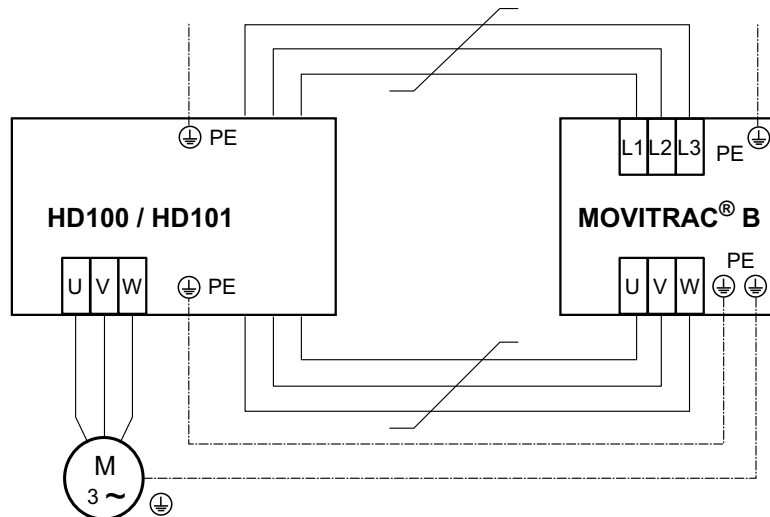

4.3.6 FKE12B / FKE13B EMC-modules

Use the supplied screws to mount the EMC module together with the MOVITRAC[®] B frequency inverter onto the conductive mounting surface in the control cabinet.

The connections U / V / W are labeled U / V / W and have to be connected accordingly.

The connections L1 / L2 / L3 (brown / orange / white) can be connected in any order.

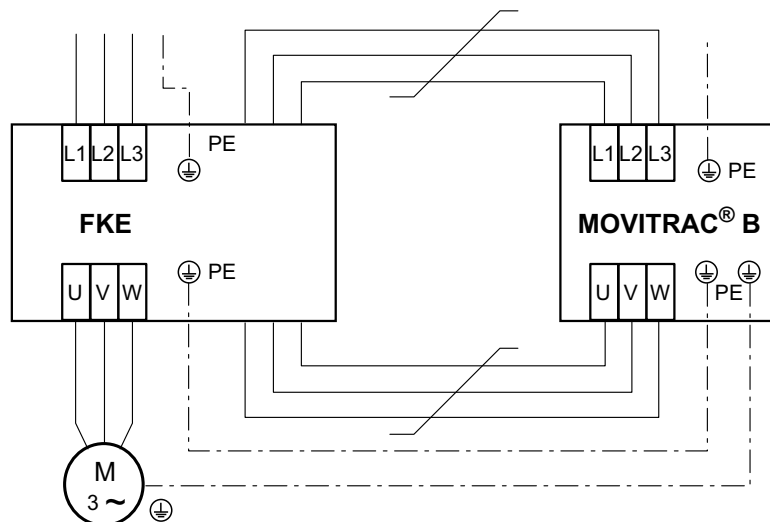

kVA	n
	f
i	
P	Hz

4.3.7 PTC braking resistors BW1 / BW3 with FKB10B

BW1 and BW3 PTC braking resistors [1] can be mounted to the shield plate under the inverter using the angle bracket FKB10B [2], part number 18216218 available as option.

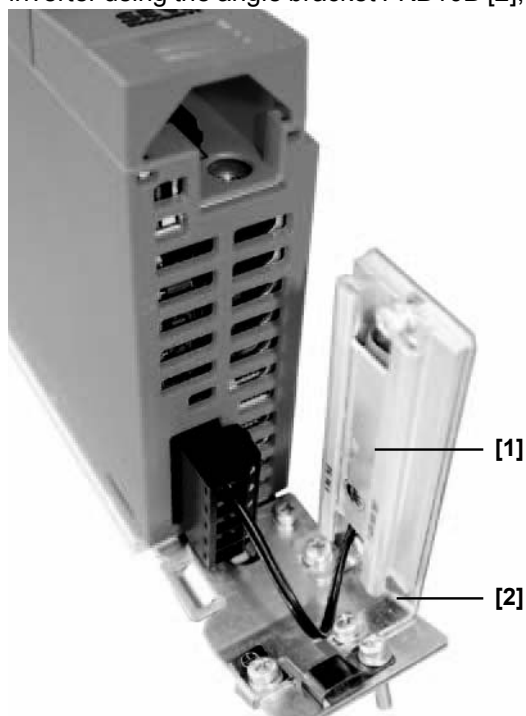

4.3.8 Flat-design resistors with FKB11B / FKB12B / FKB13B and FHS11B / FHS12B / FHS13B

Flat-design braking resistors can be installed as follows:

- Installation on the back panel of the control cabinet: FKB11B / FKB12B / FKB13B
- Installation with mounting rail: FHS11B / FHS12B / FHS13B

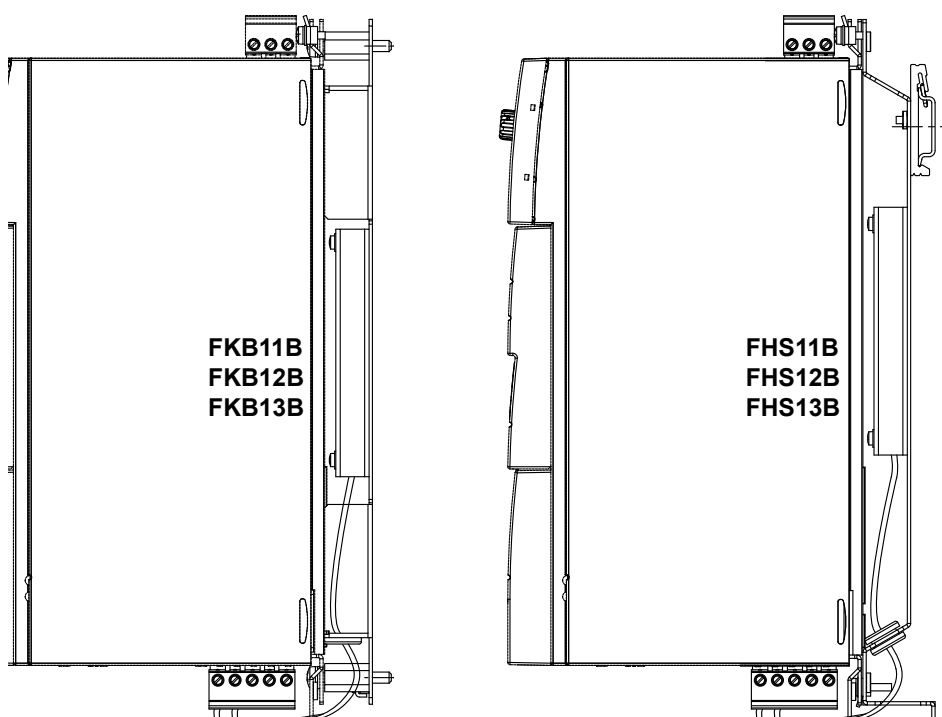

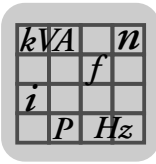

4.4 UL compliant installation

Note the following points for UL-compliant installation:

- Only use copper cables with the following temperature ranges as connection cables:
 - MOVITRAC[®] B 0003 – 0300: Temperature range 60/75 °C (140/167 °F)
 - MOVITRAC[®] B 0370 and 0450: Temperature range 75 °C (167 °F)
- Necessary tightening torques of MOVITRAC[®] B power terminals: See technical data.
- Operate the inverters on supply systems with a maximum phase-to-earth voltage of AC 300 V only.
- The inverter can only be operated on IT systems if the phase-to-earth voltage of AC 300 V cannot be exceeded either during operation or in case of an error.
- MOVITRAC[®] B frequency inverters are only allowed to be operated on supply systems which can supply maximum values in accordance with the following table. Only use melting fuses. The performance data of the fuses must not exceed the values in the following table.

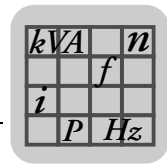

4.4.1 Maximum values/fuses

The following maximum values/fuses must be observed for UL compliant installation:

230 V units / 1-phase	Max. mains current	Max. mains voltage	Fuses
0003 / 0004 / 0005 / 0008	AC 5000 A	AC 240 V	15 A / 250 V
0011 / 0015 / 0022	AC 5000 A	AC 240 V	30 A / 250 V

230 V units / 3-phase	Max. mains current	Max. mains voltage	Fuses
0003 / 0004 / 0005 / 0008	AC 5000 A	AC 240 V	15 A / 250 V
0011 / 0015 / 0022	AC 5000 A	AC 240 V	20 A / 250 V
0037	AC 5000 A	AC 240 V	30 A / 250 V
0055 / 0075	AC 5000 A	AC 240 V	110 A / 250 V
0110	AC 5000 A	AC 240 V	175 A / 250 V
0150	AC 5000 A	AC 240 V	225 A / 250 V
0220 / 0300	AC 10000 A	AC 240 V	350 A / 250 V

400/500 V units	Max. mains current	Max. mains voltage	Fuses
0003 / 0004 / 0005 / 0008 / 0011 / 0015	AC 5000 A	AC 500 V	15 A / 600 V
0022 / 0030 / 0040	AC 5000 A	AC 500 V	20 A / 600 V
0055 / 0075	AC 5000 A	AC 500 V	60 A / 600 V
0110	AC 5000 A	AC 500 V	110 A / 600 V
0150 / 0220	AC 5000 A	AC 500 V	175 A / 600 V
0300	AC 5000 A	AC 500 V	225 A / 600 V
0370 / 0450	AC 10000 A	AC 500 V	350 A / 600 V
0550 / 0750	AC 10000 A	AC 500 V	500 A / 600 V



TIPS

- Use only tested units with a limited output voltage ($V_{\max} = \text{DC } 30 \text{ V}$) and limited output current ($I \leq 8 \text{ A}$) as an external DC 24 V voltage source.
- UL certification does not apply to operation in voltage supply systems with a non-grounded star point (IT systems).

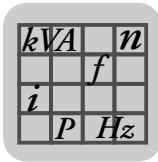

4.5 Installation of loose items

4.5.1 Scope of delivery of loose items

The scope of delivery includes a bag for loose items. Its contents depends on the size of the inverter.

Scope of delivery of loose items for size					
0XS / 0S / 0L	1	2S	2	3	4 / 5
<ul style="list-style-type: none"> Shield plate for control electronics with clamps and screws [1] 3 connectors for electronics terminals [2] 					
<ul style="list-style-type: none"> Grounding terminals with screws [4] 				-	
<ul style="list-style-type: none"> Shield plate for the power section with clamps and screws [3] Connector for mains (2 or 3-pole) and motor [5] Plastic insulations with stickers [6] 	<ul style="list-style-type: none"> Shield plate for the power section without screws 	<ul style="list-style-type: none"> Touch guard Shield plate for the power section with screws 	-		
	<ul style="list-style-type: none"> Fixing straps 		-		
<ul style="list-style-type: none"> Touch guard 					

Loose items for size 0:

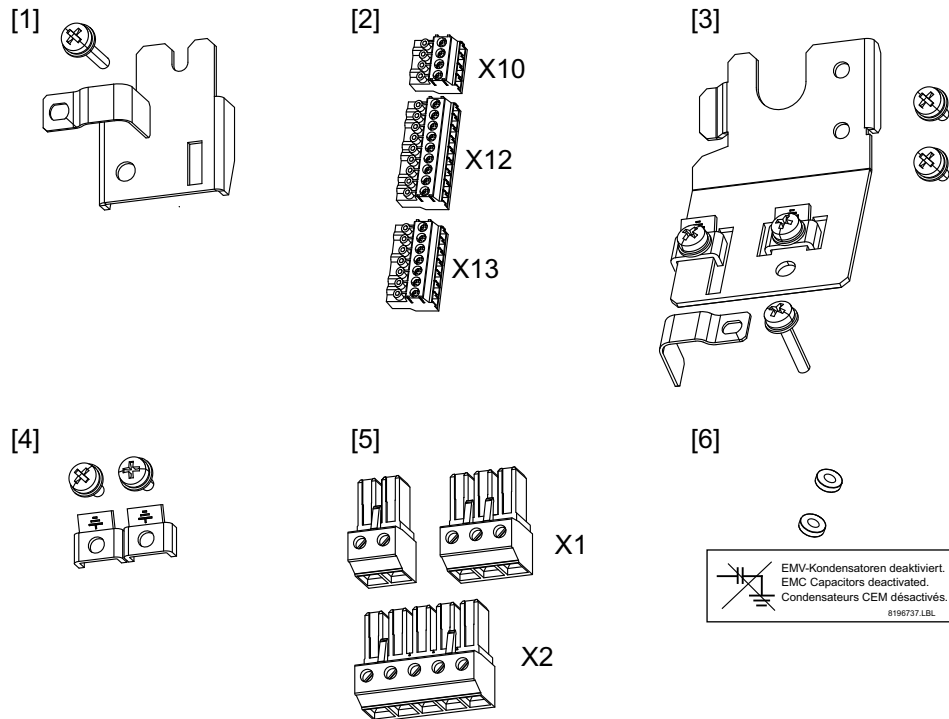

kVA	n
	f
i	
P	Hz

4.5.2 Installing shield plate for control electronics (all sizes)

MOVITRAC® B includes a shield plate for the control electronics with a retaining screw as standard. Install the shield plate for control electronics as follows:

1. Loosen the screw first [1].
2. Insert the shield clamp into the slot in the plastic housing.
3. Fasten the shield clamp.



[1]

4.5.3 Installing shield plate for power section

Size 0

A power shield plate for the power section with 2 retaining screws is supplied as standard with MOVITRAC® size 0.

Mount the shield plate for the power section using the two retaining screws.



[1] PE connection

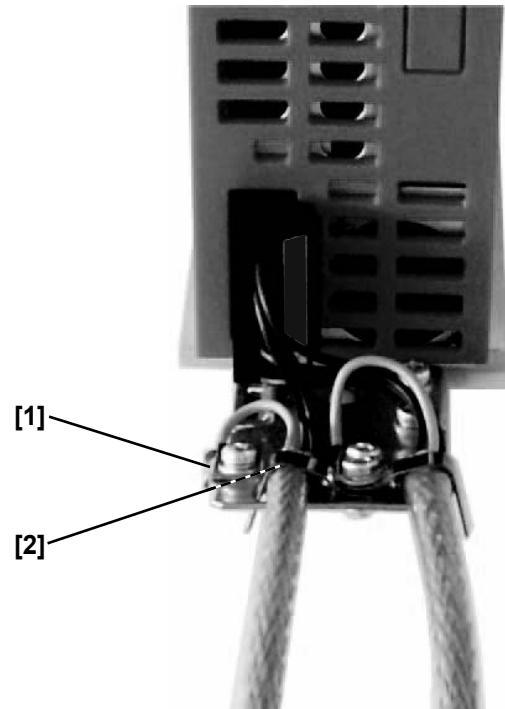

[2] Shield plate

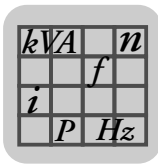

Installation

Installation of loose items

Size 1

SEW-EURODRIVE supplies a shield plate for the power section as standard with MOVITRAC® B size 1. Mount the shield plate for the power section using the unit's two retaining screws.

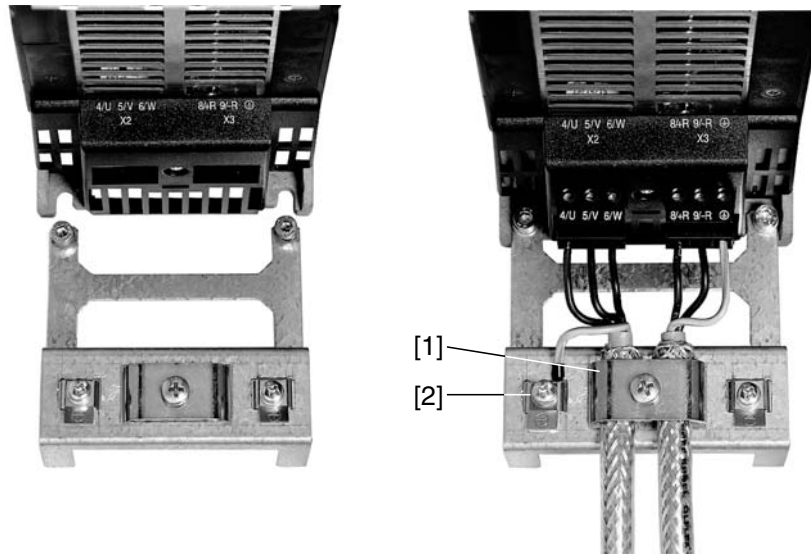

[1] Shield clamp

[2] PE connection

Sizes 2S / 2

SEW-EURODRIVE supplies a shield plate for the power section with two retaining screws as standard with MOVITRAC® B sizes 2S / 2. Mount the shield plate for the power section using the two retaining screws. The illustration shows size 2.

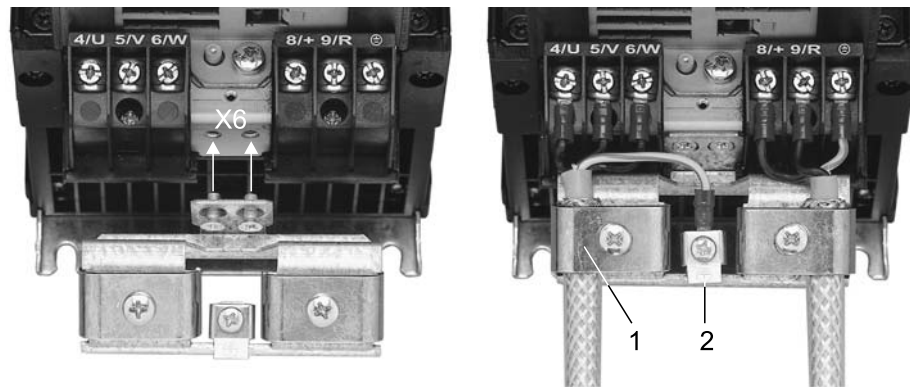

[1] Shield clamp

[2] PE connection

The shield plate for the power section provides you with a very convenient way of installing the shield for the motor and brake cables. Apply the shield and PE conductor as shown in the figures below.

Sizes 3 – 5

No shield plates for the power section are supplied with MOVITRAC® B sizes 3 to 5. Use commercially available shield clamps for installing the shielding of motor and brake cables. Apply the shield as closely as possible to the inverter.

4.5.4 Installing the touch guard

	! DANGER
	<p>Uncovered power connections.</p> <p>Severe or fatal injuries from electric shock.</p> <ul style="list-style-type: none"> • Install the touch guard according to the regulations. • Never start the unit if the touch guard is not installed.

Size 2S

SEW-EURODRIVE supplies two touch guards for the DC link and braking resistor terminals as standard with MOVITRAC® B size 2S. Without touch guard, MOVITRAC® B size 2S has degree of protection IP10. When the touch guard is installed, the unit has degree of protection IP20.

Install the touch guard as shown in this illustration:

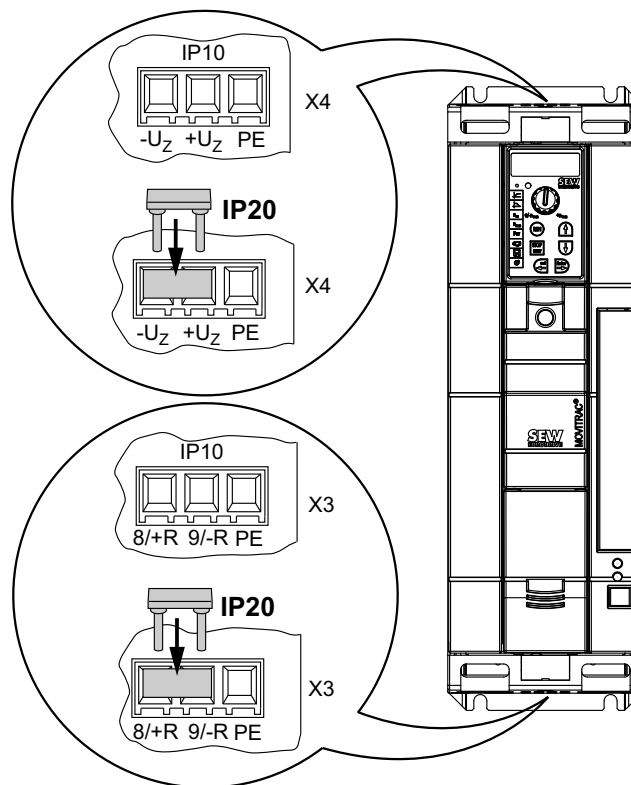

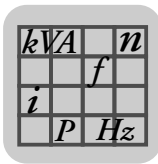

Installation

Installation of loose items

Sizes 4 / 5

Two touch guards with 8 retaining screws are supplied as standard with MOVITRAC® B sizes 4 / 5. Install the touch guard on both covers of the power section terminals.

Touch guard for MOVITRAC® B sizes 4 / 5:

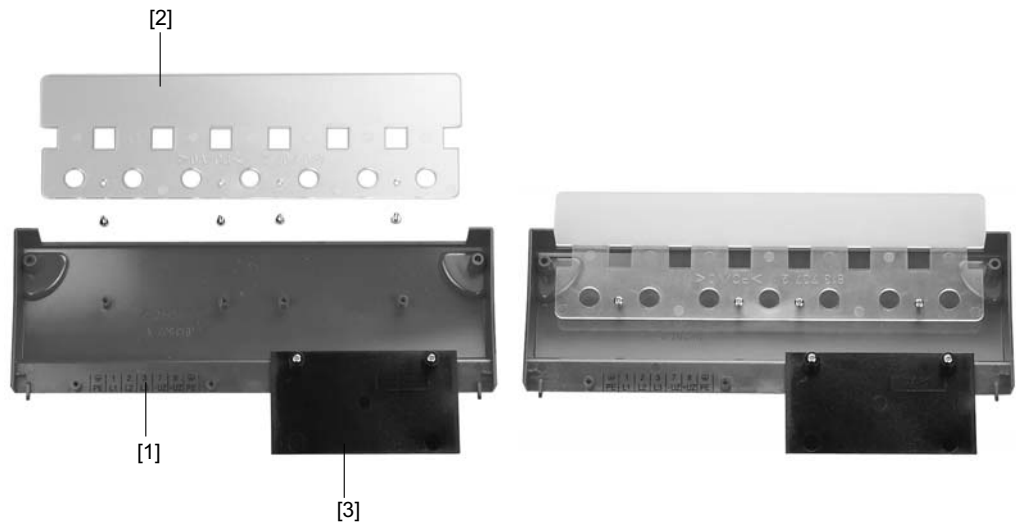

The touch guard comprises the following parts:

- [1] Cover plate
- [2] Connection plate
- [3] Screen (only for size 4)

MOVITRAC® B unit sizes 4 / 5 can only achieve degree of protection IP10 when the following conditions are met:

- Touch guard is fully installed
- The shrink tubing is installed on all power terminals (X1, X2, X3, X4)



TIP

If the above conditions are not met, MOVITRAC® unit sizes 4 and 5 have degree of protection IP00.

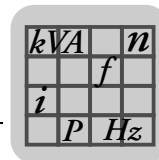

4.6 Requirements for installing cold plate (size 0 only)

The frequency inverter power loss can be dissipated via coolers that work with different cooling media (air, water, oil, etc.). This can be useful, for example, in restricted installation spaces. When adhering to the usual installation notes (40 °C (104 °F) / 100 mm (3.94 in) space above and below), cold-plate technology is not necessary.

A good thermal connection to the cooler is important for safe operation of the frequency inverters:

- The contact area between cooler and frequency inverter has to be the size of the frequency inverter cooling plate.
- Level contact surface, deviation max. up to 0.05 mm (0.0002 in).
- Connect cooler and cooling plate with all necessary screw connections.
- The mounting plate must not exceed 70 °C (158 °F) during operation. This must be ensured by the cooling medium.
- Cold plate installation is not possible with FHS or FKB.

4.7 Deactivating EMC capacitors (size 0 only)

Only electricians are allowed to convert the unit. Once converted, the unit must be marked with the sticker provided in the accessory bag.

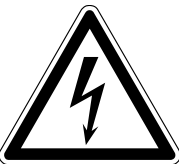
	<p>! DANGER</p>
<p>Severe or fatal injuries from electric shock.</p> <ul style="list-style-type: none"> • Disconnect the inverter from the power. Switch off the DC 24 V and the mains voltage. • Wait 10 seconds. • Ensure that the unit is de-energized. • Take appropriate measures to avoid electrostatic charges (use discharge strap, conductive shoes, etc.) before removing the cover. • Touch only the unit frame and heat sink. Do not touch any electronic components. 	

Proceed as follows to deactivate the EMC capacitors for MOVITRAC® B:

1. Open the unit:
 - Remove **all** connectors.
 - Remove the electronics shield clamp.
 - Remove the housing retaining screw in the center of the housing front.
 - Remove the housing.

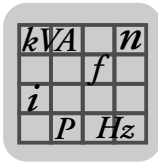

Installation

Deactivating EMC capacitors (size 0 only)

2. Remove the two screws [A] securing the circuit board.
3. Install the screws in the plastic insulations provided [B].
4. Fasten screws to the unit [C].
5. Close the unit.
6. Attach the sticker provided to the unit.

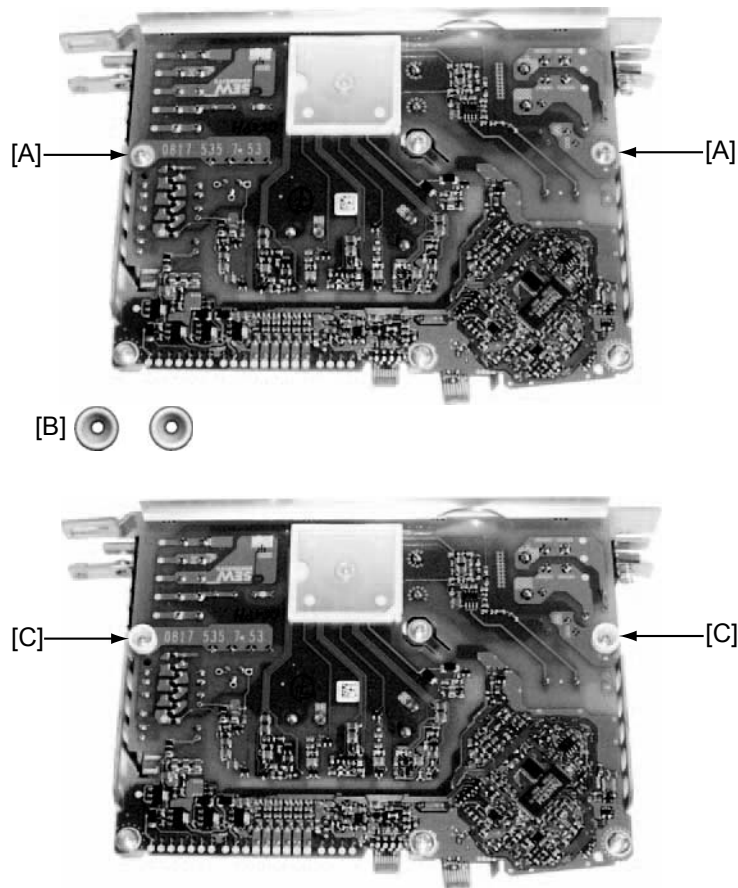

Deactivating the EMC capacitors stops earth-leakage currents from flowing over the EMC capacitors.

- Ensure that the earth-leakage currents are essentially only determined by the level of the DC link voltage, the PWM frequency, the applied motor cable and its length and the motor used.

When the suppression capacitors are deactivated, the EMC filter is no longer active.



TIP

IT systems

- No EMC limits are specified for interference emission in voltage supply systems without a grounded star point (IT systems).

4.8 Wiring diagram

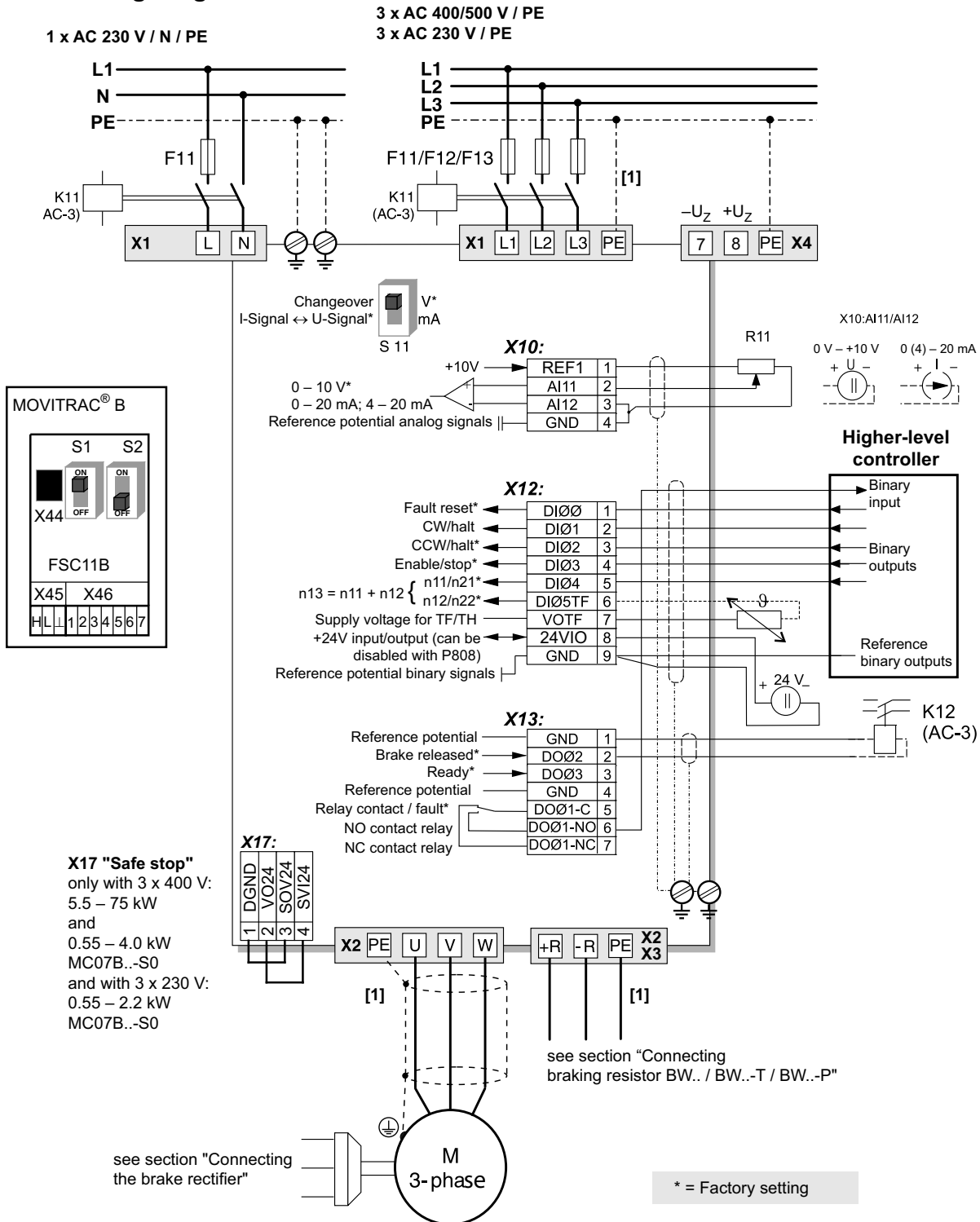

[1] In sizes 1, 2S, and 2, there is no PE connection next to the power supply connection terminals and motor connection terminals [X1]/[X2]. In this case, use the PE terminal next to the DC link connection [X4].

X4 is only available in sizes 1 – 5. From size 3 onwards, there are two additional PE terminals.

DC 24 V external at X12:8 / X12:9 as option except for "safe stop" MC07B..-S0.

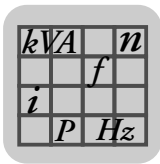

4.9 TF thermistor and TH bimetallic switch

The winding temperature is monitored using TF thermistors or TH bimetallic switches. Connect TF or TH to the TF output VOTF and the TF input DI05TF of MOVITRAC®. Set binary input DI05TF to TF signal. The temperature will then be monitored by MOVITRAC®; no additional monitoring unit is required.

You can also connect TH bimetallic switches to 24VIO and a binary input. Set the binary input to /External fault.

4.10 Connecting braking resistor BW..-P / BW..-T / BW.. to X3 / X2

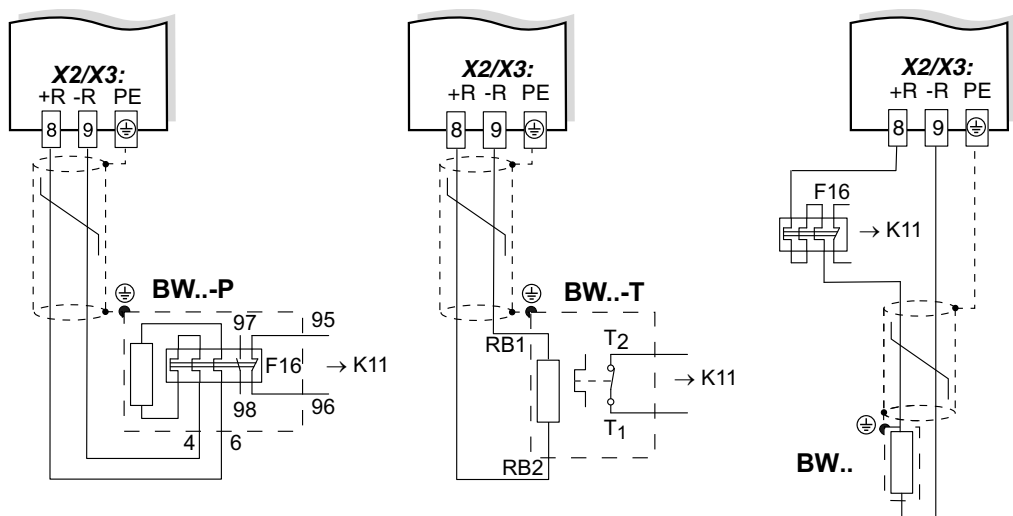

Set a terminal to "/Controller inhibit". K11 must be opened and "/Controller inhibit" must receive a "0" signal in the following cases:

- BW..-P: The auxiliary contact trips
- BW..-T: The internal temperature switch trips
- BW..: The external bimetallic relay F16 trips

The resistor circuit must not be interrupted.

Overload protection for braking resistors BW:

Braking resistor type	Design specified	Overload protection	
		Internal temperature switch (..T)	External bimetallic relay (F16)
BW..	–	–	Required
BW..-T ¹⁾	–	One of the two options (internal temperature switch / external bimetallic relay) is required.	
BW..-003 / BW..-005	Adequate	–	Permitted

1) Permitted mounting options: On horizontal or vertical surfaces with brackets at the bottom and perforated sheets at top and bottom. **Mounting not permitted:** On vertical surfaces with brackets at the top, right or left.

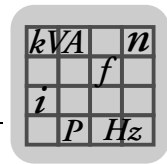

4.11 Connecting brake rectifiers

i	TIP
	The connection of the brake rectifier requires a separate supply system cable; supply from the motor voltage is not permitted!

Use only contactors of utilization category AC-3 for K11 and K12.

Switch off the brake on the DC and AC sides with:

- All hoist applications.
- Drives which require a rapid brake response time.

If the brake rectifier is installed in the control cabinet, route the connecting leads between the brake rectifier and the brake separately from other power cables. Routing together with other cables is only permitted if the other cables are shielded.

Wiring diagrams

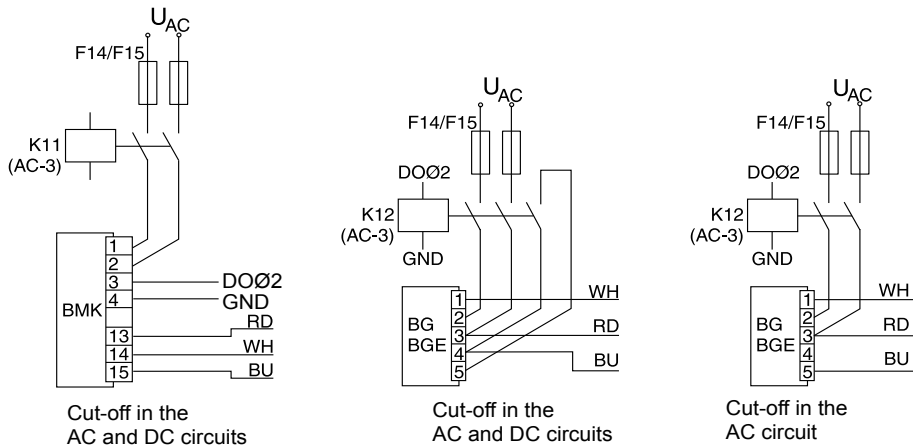

Note the corresponding connection regulations for brakes without BG/BGE or BME. Refer to the SEW publication "Drive Engineering – Practical Implementation: SEW Disk Brakes".

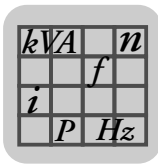

4.12 Installing FSC11B / FIO11B / FIO21B

You can enhance the basic units using the FSC11B, FIO11B, and FIO21B modules.

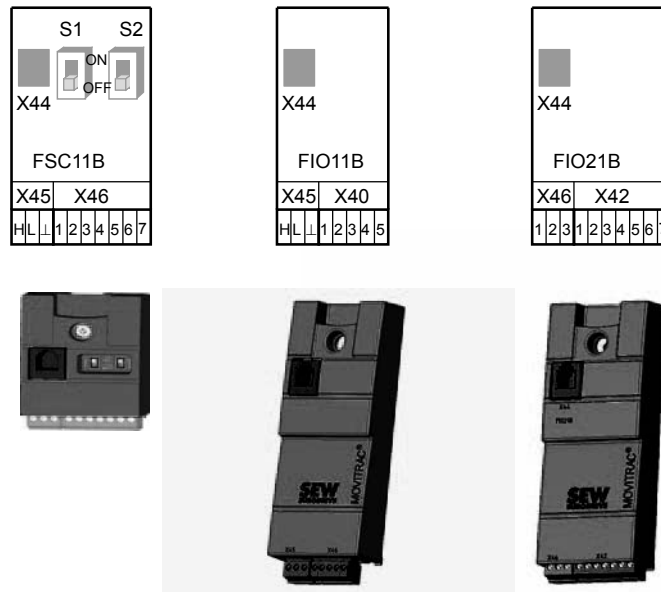

Connection/unit	FSC11B	FIO11B	FIO21B
RS-485 service interface X44	yes	yes	yes
RS-485 terminal connection X45	yes	yes	no
SBus connection X46	yes	no	yes
Analog input/output X40	no	yes	no
Binary inputs X42	no	no	yes

4.12.1 Mounting and installation on FSC11B / FIO11B / FIO21B

Always attach the option to the unit with the screw that is included in the delivery. For size 0, mount the spacer bolt first. The bolt is already installed in sizes 1 and higher. Fitting the screw secures the high-frequency EMC connection between the basic unit and the option.

Function	Terminal	Description	Data	FSC11B	FIO11B	FIO21B
Service interface	X44	Via RJ10 plug connector	Only for service purposes Maximum cable length 3 m (10 ft)	yes	yes	yes
RS-485 interface	X45:H	ST11: RS-485+		yes	yes	no
	X45:L	ST12: RS-485-				
	X45:⊥	GND: Reference potential				
System bus	X46:1	SC11: SBus high	CAN bus to CAN specification 2.0, parts A and B Max. 64 stations	yes ¹⁾	no	yes ²⁾
	X46:2	SC12: SBus Low				
	X46:3	GND: Reference potential				
	X46:4	SC21: SBus High				
	X46:5	SC22: SBus Low				no
	X46:6	GND: Reference potential				

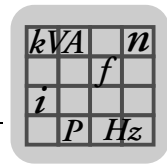

Function	Terminal	Description	Data	FSC11B	FIO11B	FIO21B
DC 24 V	X46:7	24VIO: Auxiliary voltage / external voltage supply		yes	no	no
Analog input	X40:1	AI2: Voltage input	-10 – +10 V R _i > 40 kΩ Resolution 10 bit Sampling time 5 ms	no	yes	yes
	X40:2	GND: Reference potential				
Analog output	X40:3	GND: Reference potential	0 – +10 V I _{max} = 2 mA 0 (4) – 20 mA Resolution 10 bit Sampling time 5 ms Short-circuit proof, protected against external voltage up to 30 V	no	yes	yes
	X40:4	AOV1: Voltage output				
	X40:5	AOI1: Current output				
Binary inputs	X42:1	DI10	R _i = 3 kΩ, I _E = 10mA, sampling time 5 ms, PLC-compatible	no	no	yes
	X42:2	DI11				
	X42:3	DI12				
	X42:4	DI13				
	X42:5	DI14				
	X42:6	DI15				
	X42:7	DI16				

- 1) Terminating resistor 120 Ω can be activated via DIP switch
- 2) Bus termination possible with enclosed 120 Ω resistor.

The DC 24 V function of X46:7 is identical to X12:8 of the basic unit. All GND terminals of the unit are connected to each other and to PE.

Cable specification

- Use a 4-core twisted and shielded copper cable (data transmission cable with braided copper shield). The cable must meet the following specifications:
 - Cable cross-section 0.25 to 0.75 mm² (AWG 23 - AWG 18)
 - Cable resistance 120 Ω at 1 MHz
 - Capacitance per unit length ≤ 40 pF/m at 1 kHz
- Suitable cables include CAN bus or DeviceNet cables.

Connecting the shield

- Connect the shield to the electronics shield clamp on the inverter or master controller and make sure it is connected over a wide area at both ends.
- There is no need for a ground connections between MOVITRAC® B and gateways, or MOVITRAC® B and MOVITRAC® B with shielded cables. A 2-core cable is permitted in this case.
- When connecting MOVIDRIVE® B and MOVITRAC® B, be aware that the electrical isolation is eliminated between the reference potential DGND and ground in MOVIDRIVE® B.

	CAUTION
	<p>Potential displacement</p> <p>Possible consequences include malfunctions that could lead to irreparable damage to the unit.</p> <ul style="list-style-type: none"> • There must not be any potential displacement between the connected units. Take appropriate measures to avoid potential displacement, such as connecting the unit ground connectors using a separate cable.

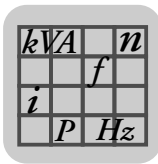

4.12.2 Installing the system bus (SBus) to FSC11B

Max. 64 CAN bus stations can be addressed via system bus (SBus). The SBus supports transmission technology compliant with ISO 11898.

S1	S2	SC11/SC12	SC21/SC22
off	off	CAN1	CAN1
on	off	CAN1 concluded	–
X	on	Reserved	

MOVITRAC® B system bus connection

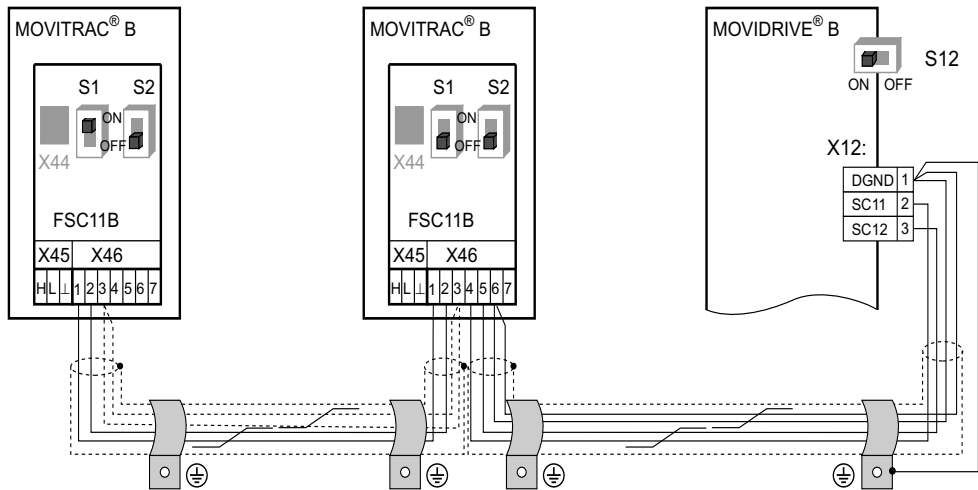

MOVITRAC® B system bus connection with UFx

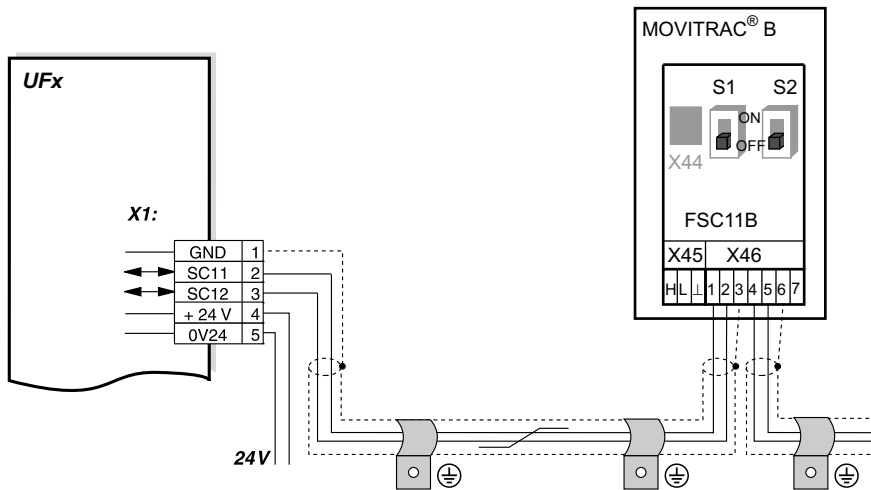

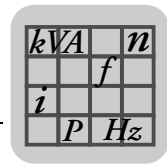

MOVITRAC[®] B system bus connection with DFx/UOH11B gateways or DFx integrated in MOVITRAC[®] B

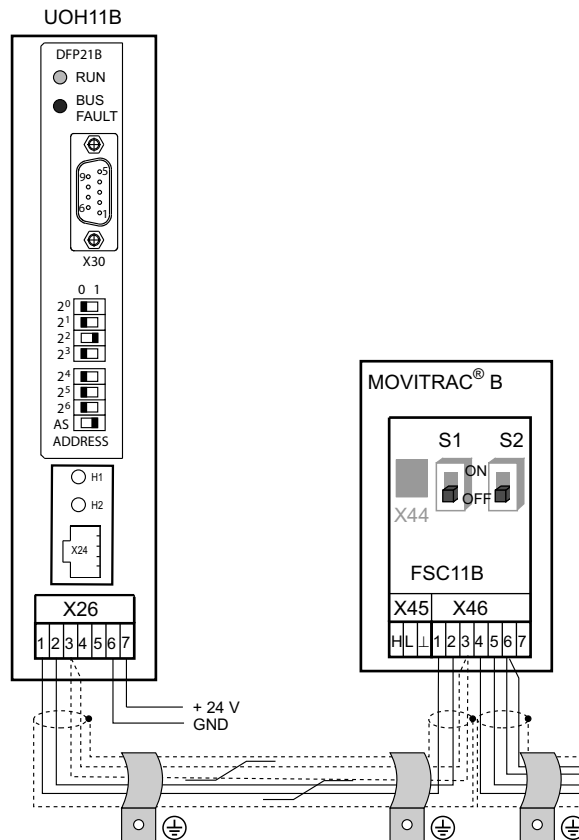

Cable length

- The permitted total cable length depends on the baud rate setting of the SBus (P884):
 - 125 kBaud: 320 m (1050 ft)
 - 250 kBaud: 160 m (525 ft)
 - **500 kBaud: 80 m (260 ft)**
 - 1000 kBaud: 40 m (130 ft)
- You must use shielded cables.

i	<p>TIP</p> <p>Terminating resistor: Switch on the system bus terminating resistor (S1 = ON) at the start and end of the system bus connection. Switch off the terminating resistor on the units in between (S1 = OFF).</p> <p>Certain units have a permanently integrated terminating resistor that cannot be switched off. This is the case for UFx and DFx/UOH. These gateways form the end of the physical line. Do not connect any external terminating resistors.</p>
----------	--

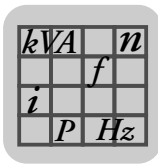

4.12.3 Installing RS-485 interface to FSC11B

The RS-485 interface can be used for connecting max. 32 MOVITRAC® units or 31 MOVITRAC® units and a higher-level controller (PLC).

MOVITRAC® B RS-485 connection

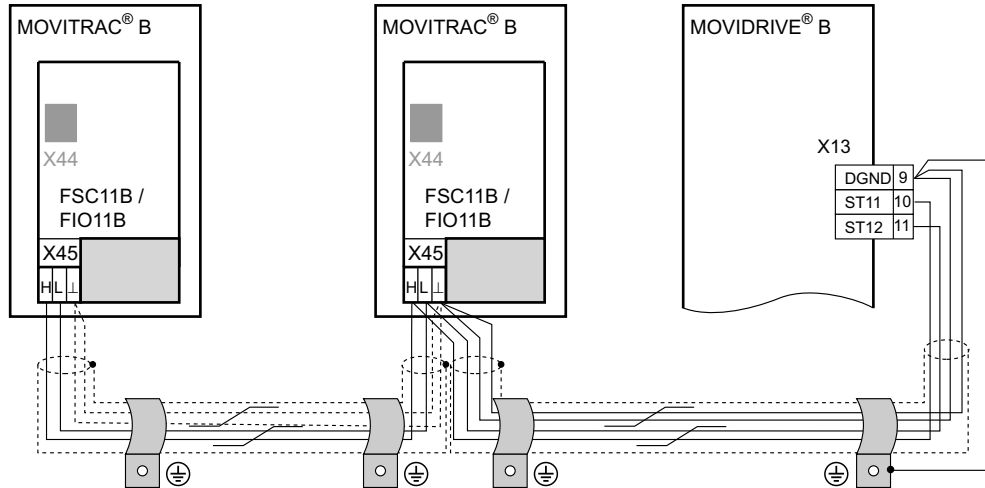

Cable length

- The permitted total cable length is 200 m.
- You must use shielded cables.



TIP

Terminating resistor: Dynamic terminating resistors are installed. **Do not connect any external terminating resistors.**

4.12.4 Wiring the FIO11B analog module

Bipolar analog input AI2	Unipolar analog input AI2	Current analog output AOC1	Voltage analog output AOV1																																																																
<table border="1"> <tr> <td>X45</td> <td>X40</td> </tr> <tr> <td>RS-485+</td> <td>RS-485-</td> </tr> <tr> <td>HL</td> <td>⊥</td> </tr> <tr> <td>1</td> <td>2</td> </tr> <tr> <td>2</td> <td>3</td> </tr> <tr> <td>3</td> <td>4</td> </tr> <tr> <td>4</td> <td>5</td> </tr> <tr> <td>AOV1</td> <td>AOC1</td> </tr> </table> <p> </p>	X45	X40	RS-485+	RS-485-	HL	⊥	1	2	2	3	3	4	4	5	AOV1	AOC1	<table border="1"> <tr> <td>X45</td> <td>X40</td> </tr> <tr> <td>RS-485+</td> <td>RS-485-</td> </tr> <tr> <td>HL</td> <td>⊥</td> </tr> <tr> <td>1</td> <td>2</td> </tr> <tr> <td>2</td> <td>3</td> </tr> <tr> <td>3</td> <td>4</td> </tr> <tr> <td>4</td> <td>5</td> </tr> <tr> <td>AOV1</td> <td>AOC1</td> </tr> </table> <p> </p>	X45	X40	RS-485+	RS-485-	HL	⊥	1	2	2	3	3	4	4	5	AOV1	AOC1	<table border="1"> <tr> <td>X45</td> <td>X40</td> </tr> <tr> <td>RS-485+</td> <td>RS-485-</td> </tr> <tr> <td>HL</td> <td>⊥</td> </tr> <tr> <td>1</td> <td>2</td> </tr> <tr> <td>2</td> <td>3</td> </tr> <tr> <td>3</td> <td>4</td> </tr> <tr> <td>4</td> <td>5</td> </tr> <tr> <td>AOV1</td> <td>AOC1</td> </tr> </table> <p> </p> <p>$R_L \leq 750 \Omega$</p>	X45	X40	RS-485+	RS-485-	HL	⊥	1	2	2	3	3	4	4	5	AOV1	AOC1	<table border="1"> <tr> <td>X45</td> <td>X40</td> </tr> <tr> <td>RS-485+</td> <td>RS-485-</td> </tr> <tr> <td>HL</td> <td>⊥</td> </tr> <tr> <td>1</td> <td>2</td> </tr> <tr> <td>2</td> <td>3</td> </tr> <tr> <td>3</td> <td>4</td> </tr> <tr> <td>4</td> <td>5</td> </tr> <tr> <td>AOV1</td> <td>AOC1</td> </tr> </table> <p> </p>	X45	X40	RS-485+	RS-485-	HL	⊥	1	2	2	3	3	4	4	5	AOV1	AOC1
X45	X40																																																																		
RS-485+	RS-485-																																																																		
HL	⊥																																																																		
1	2																																																																		
2	3																																																																		
3	4																																																																		
4	5																																																																		
AOV1	AOC1																																																																		
X45	X40																																																																		
RS-485+	RS-485-																																																																		
HL	⊥																																																																		
1	2																																																																		
2	3																																																																		
3	4																																																																		
4	5																																																																		
AOV1	AOC1																																																																		
X45	X40																																																																		
RS-485+	RS-485-																																																																		
HL	⊥																																																																		
1	2																																																																		
2	3																																																																		
3	4																																																																		
4	5																																																																		
AOV1	AOC1																																																																		
X45	X40																																																																		
RS-485+	RS-485-																																																																		
HL	⊥																																																																		
1	2																																																																		
2	3																																																																		
3	4																																																																		
4	5																																																																		
AOV1	AOC1																																																																		

4.13 Installing the MBG11A speed control module

- A Mounting from the rear using 4 tapped holes.
- B Mounting from the front using 2 retaining holes

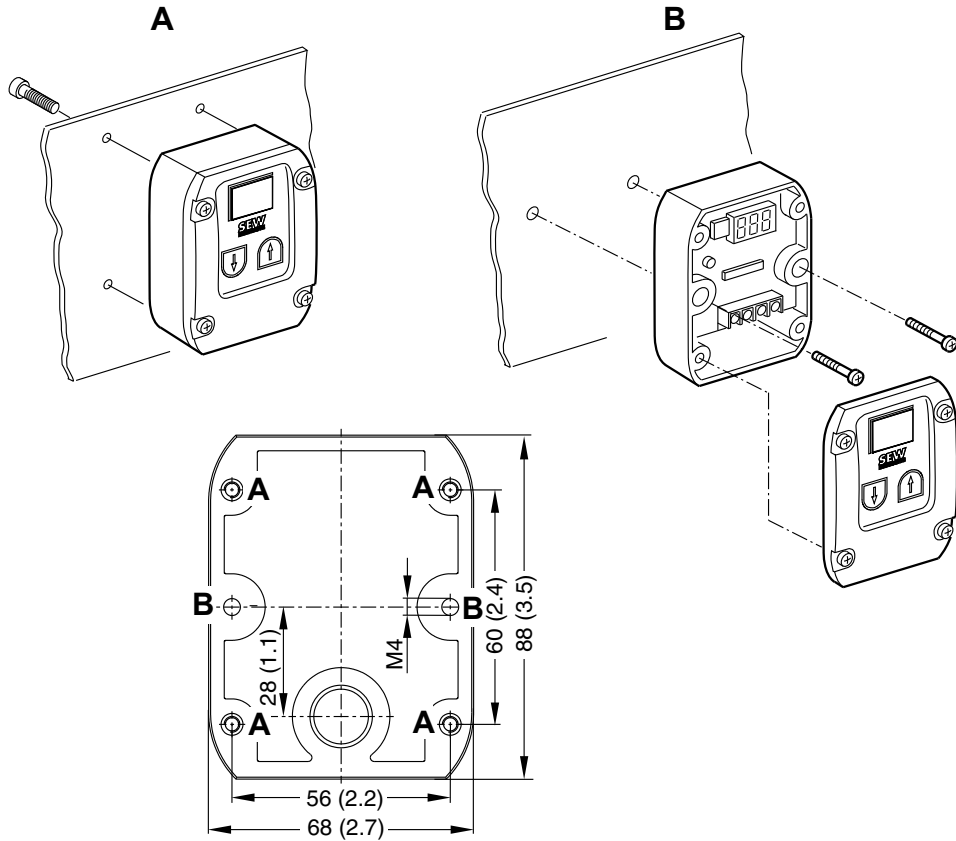

4.13.1 Connection

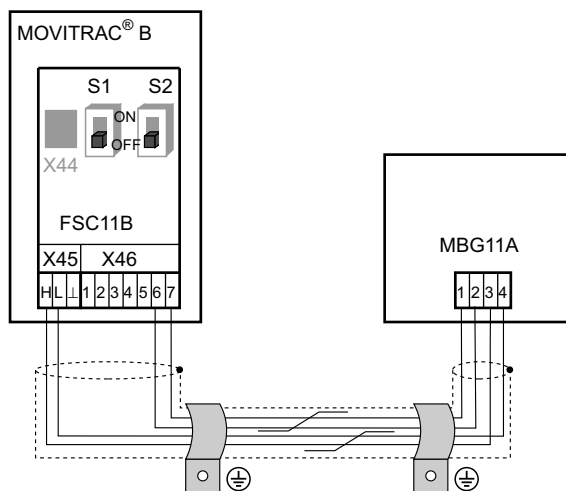

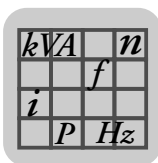

Startup

Brief description of the startup process

5 Startup

5.1 Brief description of the startup process

You can directly connect the MOVITRAC® B frequency motor to a motor with the same power rating. For example: A 1.5 kW (2.0 HP) motor can be connected directly to a MC07B0015.

5.1.1 Procedure

1. Connect the motor to MOVITRAC® B (terminal X2).
2. You have the option of connecting a braking resistor (terminal X2/X3).
3. The following signal terminals must be controlled with your control system:
 - Enable DIØ3
 - As required: CW/halt DIØ1 or CCW/halt DIØ2
 - Setpoint:
 - Analog input X10 and/or
 - DIØ4 = n11 = 150 rpm or/and
 - DIØ5 = n12 = 750 rpm or/and
 - DIØ4 + DIØ5 = n13 = 1500 rpm
 - For brakemotors:
 - DOØ2 = Brake control using brake rectifiers
4. You have the option of connecting the following signal terminals:
 - DIØØ = Fault reset
 - DOØ1 = /Fault (designed as relay contact)
 - DOØ3 = Ready
5. Check the controller for the required functionality.
6. Connect the frequency inverter to the mains (X1).

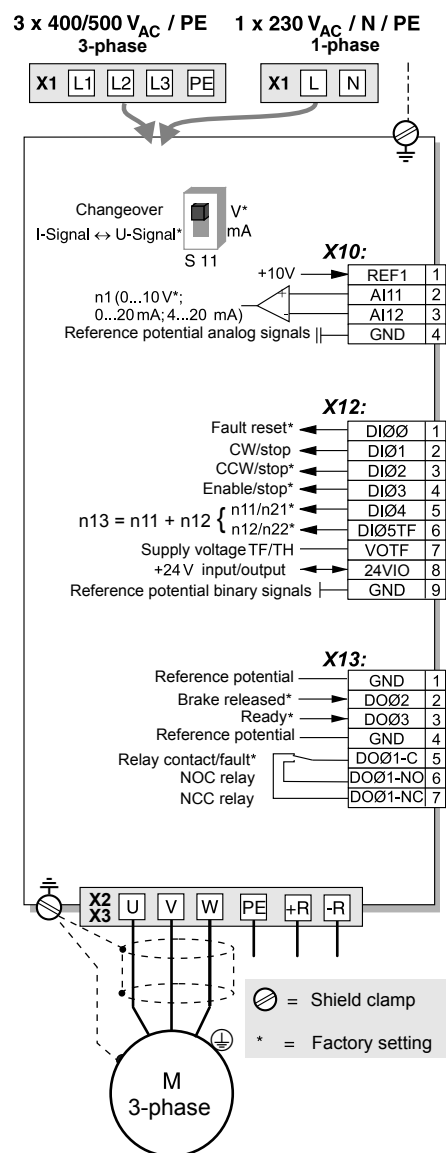

5.1.2 Notes

Signal terminal functions and setpoint settings can be modified using the FBG11B keypad or a PC. A PC connection requires the FSC11B front option or one of the following interface adapters: UWS21B / UWS11A / USB11A.

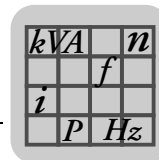

5.2 General startup instructions

	<p>! DANGER</p>
	<p>Uncovered power connections. Severe or fatal injuries from electric shock.</p> <ul style="list-style-type: none"> • Install the touch guard according to the regulations. • Never start the unit if the touch guard is not installed.

5.2.1 Prerequisite

The drive must be configured correctly to ensure that startup is successful.

MOVITRAC® B frequency inverters are factory set to be taken into operation with the SEW motor adapted to the correct power level (4-pole, 50 Hz) in V/f control mode. This means you can take the adjuster motor from SEW-EURODRIVE into operation without project planning.

5.2.2 Hoist applications

	<p>! DANGER</p>
	<p>Risk of fatal injury if the hoist falls. Severe or fatal injuries.</p> <p>MOVITRAC® B can be used in hoist applications. MOVITRAC® B is not designed for use as a safety device.</p> <ul style="list-style-type: none"> • Use monitoring systems or mechanical protection devices to ensure safety.

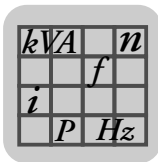

5.3 Preliminary work and resources

- Check the installation.

	! DANGER
	<p>Risk of crushing if the motor starts up unintentionally.</p> <p>Severe or fatal injuries.</p> <ul style="list-style-type: none"> • Ensure that the motor cannot start inadvertently, for example, by removing the electronics terminal block X13. • Additional safety precautions must be taken depending on the application, such as monitoring systems or mechanical protection devices, to avoid injury to people and damage to machinery.

5.3.1 Preliminary work and resources on the MOVITRAC® B basic unit

- Connect the power supply system and the motor.
- Connect the signal terminals.
- Switch on the power supply system.

5.3.2 Preliminary work and resources for MOVITRAC® B with keypad

- Connect the power supply system and the motor. **Do not connect signal terminals to prevent the inverter from receiving an enable!**
- Switch on the power supply system.
- The display shows *Stop*.
- Program the signal terminals.
- Set the parameters (e.g. ramps).
- Check the set terminal assignment (P601 – P622).
- Switch off the power supply system.
- Connect the signal terminals.
- Switch on the power supply system.

	TIP
	<p>The inverter automatically changes parameter values once you perform a startup.</p>

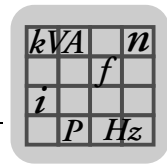







5.4 Optional keypad FBG11B

Key arrangement and symbols on the keypad:



5.4.1 Keypad functions

The UP/DOWN and ENTER/OUT buttons are used for navigating through the menus. Use the RUN and STOP/RESET buttons to control the drive. The speed control module is used for setpoint specification.

 	Use UP/DOWN to select symbols and change values.
 	Use ENTER/OUT to activate and deactivate the symbols or parameter menus
	Use "RUN" to start the drive.
	Use "STOP/RESET" to reset errors and stop the drive.



The STOP/RESET button has priority over a terminal enable or an enable via the interface. If you stop a drive using the STOP/RESET key, you have to enable it again by pressing the RUN key.



TIP

After switching off the power supply, a drive that was previously stopped using the STOP key will no longer be stopped!

The STOP/RESET key can be used for performing a reset after a fault has occurred with a programmed error response. The drive is then inhibited and must be enabled by pressing the RUN key. You can deactivate the STOP function with parameter 760 using FBG11B.



If you stop the drive with the STOP/RESET key, the display $stop$ is flashing. This signal indicates you have to enable the drive using the "RUN" key.

After copying the parameter set in MOVITRAC® B, the unit is also stopped.

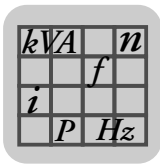

Startup
Basic operation of the FBG11B keypad

5.5 Basic operation of the FBG11B keypad

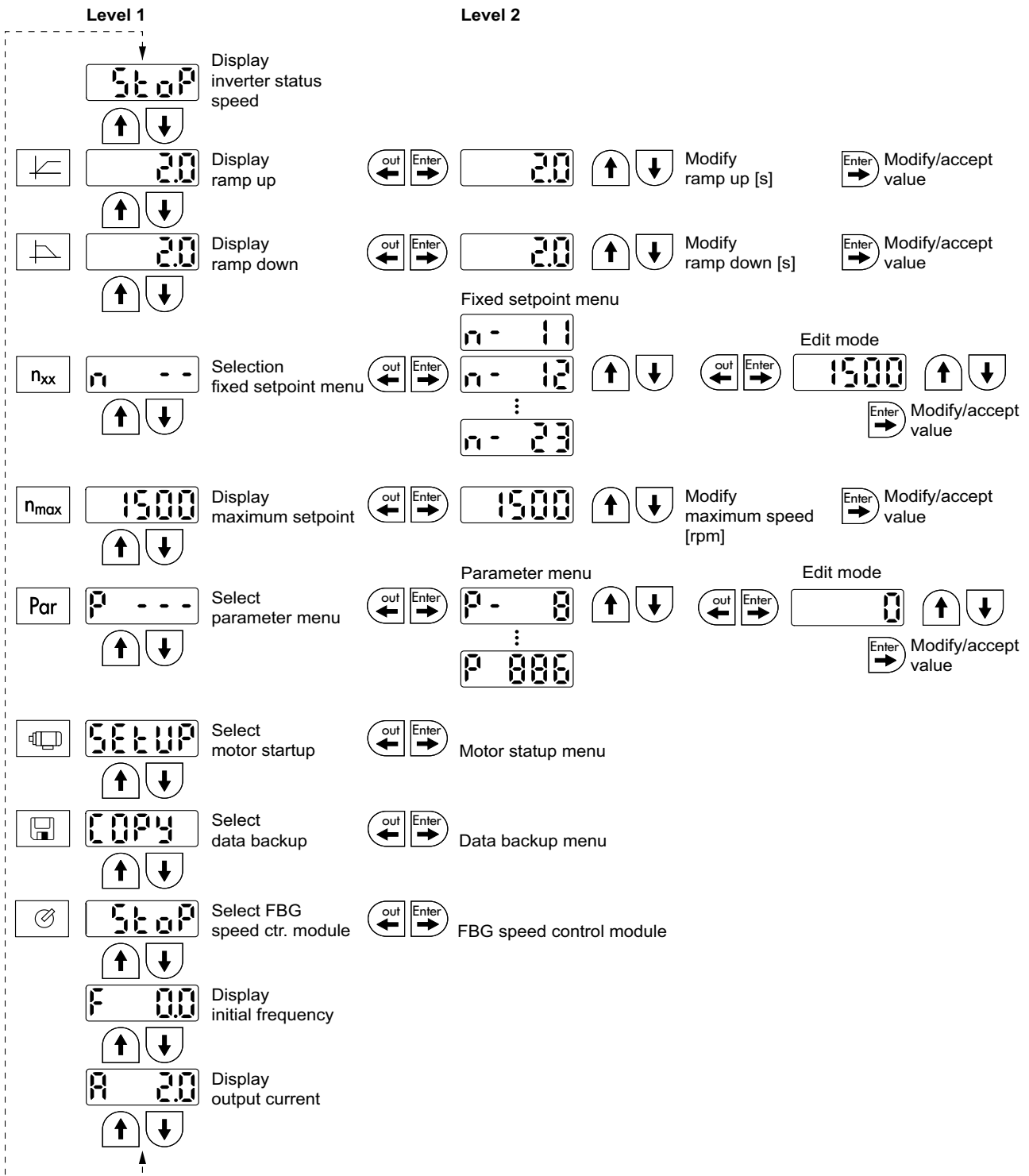

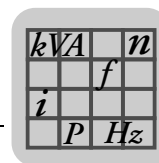

5.5.1 Menu

The LED integrated in the symbol lights up when you select a symbol. If a symbol only represents display values, the current display value appears immediately on the display.

5.5.2 Changing parameters

You can select the required parameter by selecting a symbol and pressing the ENTER key.

Press the ENTER key again to edit the parameter value. You can alter the value when the LED in the corresponding symbol flashes. When pressing the ENTER key again, the value becomes active and the LED does not flash any longer.

5.5.3 Status display

If the status is "Drive enabled", the display will show the calculated actual speed.

5.5.4 Fault display

In the event of a fault, the display changes and the fault code flashes in the display, for example F-11 (refer to the fault list in the "Service / List of Faults" section). This situation will not occur during active startup.

5.5.5 Warnings

You may not alter any parameter in any operating mode. If you try to do so, the display r-19 – r-32 will appear. The display shows a code depending on the action, e.g. r-28 (controller inhibit required). You find a list of warnings in the "Operation" section.

5.5.6 Parameter menu change short ↔ long

Using parameter P800, you can switch back and forth between short menu and long menu. The parameter description and parameter list indicates which parameters are accessible via short and long menu.

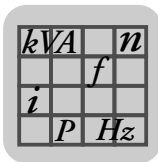

5.6 Manual operation with FBG11B speed control module

FBG11B speed control module of the keypad (local manual operation): LED flashing 

The only relevant parameters in "FBG speed control module" operating mode are:

- *P122 Direction of rotation FBG manual operation*
- "RUN" and "STOP/RESET" buttons
- Speed control module (potentiometer)

When the FBG speed control module is activated, the symbol flashes.

You limit the smallest speed with *P301 Minimum speed* and the largest speed with the n_{\max} symbol.

After a fault, a reset can be performed using the "STOP/RESET" button via the terminal or the interface. After a reset, the "manual speed control module" operating mode will be active again. The drive remains stopped.

The `stop` display flashes to indicate that you have to re-enable the drive by pressing "RUN."

The parameter *P760 Locking RUN/STOP keys* does not have any effect in "manual speed control module" operating mode.

Removing the FBG11B keypad will trigger a stop response.

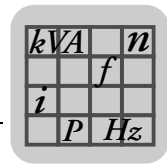

5.7 External setpoint selection

External setpoint selection

Control via

- Terminals
- Serial interface
- Setpoint potentiometer connected to AI11/AI12

5.7.1 Set direction of rotation

You can specify the set direction of rotation:

- "CW/Stop and "CCW/Stop" in *P101 control signal source = terminals* or *P101 control signal source = 3 wire-control*
- The polarity of the setpoint in the process data word in *P101 Control signal source = RS485 or SBus* and *P100 Setpoint source = RS485 or SBus*

5.7.2 Setpoint speed

You can specify the setpoint speed using:

- Speed control module if *P121 Addition FBG speed control module* is set to ON
- *P100 Setpoint source*
 - Fixed setpoints
 - Fixed setpoints with analog input
 - Process data word from SBus or RS-485
 - Motor potentiometer

5.7.3 Direction of rotation enable with RS-485 or SBus

Unipolar setpoint sources:

Unipolar / fixed setpoint
 Motor potentiometer / fixed setpoint
 Fixed setpoint + AI1
 Fixed setpoint* + AI1
 Frequency setpoint input / fixed setpoint

The direction of rotation is set with the CW or CCW terminals.

Bipolar setpoint sources:

Bipolar / fixed setpoint
 RS-485 / fixed setpoint
 SBus 1 / Fixed setpoint

The direction of rotation is determined by the setpoint. Enable with terminal CW or CCW.

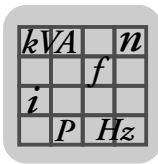

Startup

Startup using the FBG11B keypad

5.8 Startup using the FBG11B keypad

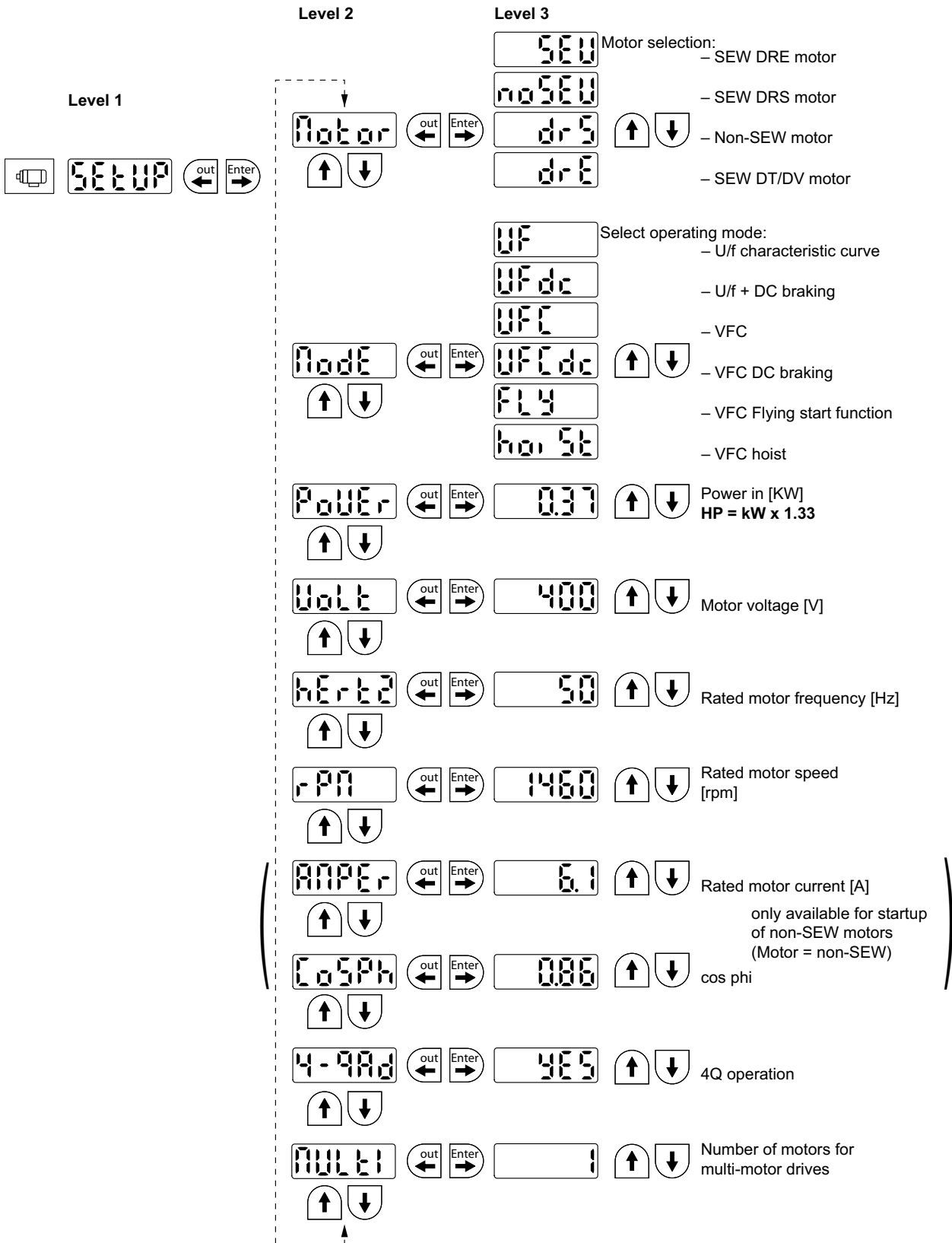

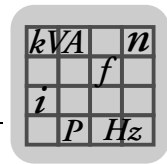

5.8.1 Required data

The following data is required to ensure startup is successful:

- Motor type (SEW or non-SEW motor)
- Motor data
 - Rated voltage and rated frequency
 - Additionally for non-SEW motors: Rated current, rated power, rated factor $\cos \phi$, and rated speed.
- Rated mains voltage

5.8.2 Activating startup

Requirements:

- Drive "No enable": stop

If a smaller or a larger motor is connected (maximum difference one size), then you have to choose the value closest to the rated motor power.

The startup procedure is not complete until you have returned to the main menu level by pressing the OUT button.

You can then perform startup only with motor parameter set 1.

	NOTE
	The SEW motor startup is designed for 4-pole motors. It may be useful to start up 2-pole or 6-pole SEW motors as non-SEW motors.

5.8.3 V/f

The default setting for the operating mode is V/f. Use this operating mode if you have no particular requirements and for applications where a high maximum speed is required.

5.8.4 VFC

Start up the inverter in VFC or VFC & DC brake operating mode for the following requirements:

- High torque
- Continuous duty at low frequencies
- Accurate slip compensation
- More dynamic behavior

For this purpose, you will have to choose the VFC or VFC & DC brake operating modes from P-01 at startup.

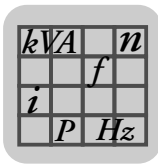

Startup

Startup using the FBG11B keypad

5.8.5 Startup of multi-motor drive

Multi-motor drives are mechanically connected to each other (e.g. chain drive with several motors). Observe the notes in the publication "Multi-Motor Drives".

Multi-motor drives are possible with installed identical SEW motors only.

- Set the multi parameter of the motor startup to the number of connected motors.

5.8.6 Startup of group drives

Group drives are mechanically decoupled from each other (e.g. different conveyor belts). In this operating mode, the inverter operates without slip compensation and with a constant V/f ratio.

You can operate a group of asynchronous motors on one inverter in V/f characteristic curve operating mode. Important:

- Select V/f operating mode
- Set the power of the largest motor
- Disable automatic adjustment P320/330
- Set boost P321/331 to zero
- Set IxR compensation P322/332 to zero
- Set slip compensation P324/334 to zero
- Set current limitation P303/313 to 1.5 times the total current of all motors
- Set I_{rated} UL monitoring P345/346 to the total current of the connected motors. Implement motor protection individually.

In this operating mode, the inverter operates without slip compensation and with a constant V/f ratio.

	NOTE
	The parameter settings apply to all connected motors.

5.8.7 Startup with large mass moment of inertia, such as with pumps and fans

Slip compensation is designed for a ratio smaller than 10 of load moment of inertia to motor moment of inertia. If the ratio is larger and the drive vibrates, then slip compensation must be reduced and even be set to 0 if necessary.

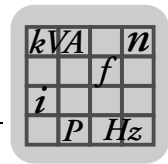

5.9 Startup with PC and MOVITOOLS® MotionStudio

Start MOVITOOLS® MotionStudio in the Windows start menu:

Programs / SEW / MOVITOOLS MotionStudio 5.x / MotionStudio 5.x

Press the MOVITOOLS® MotionStudio [Scan] button to list all connected units in the unit tree.

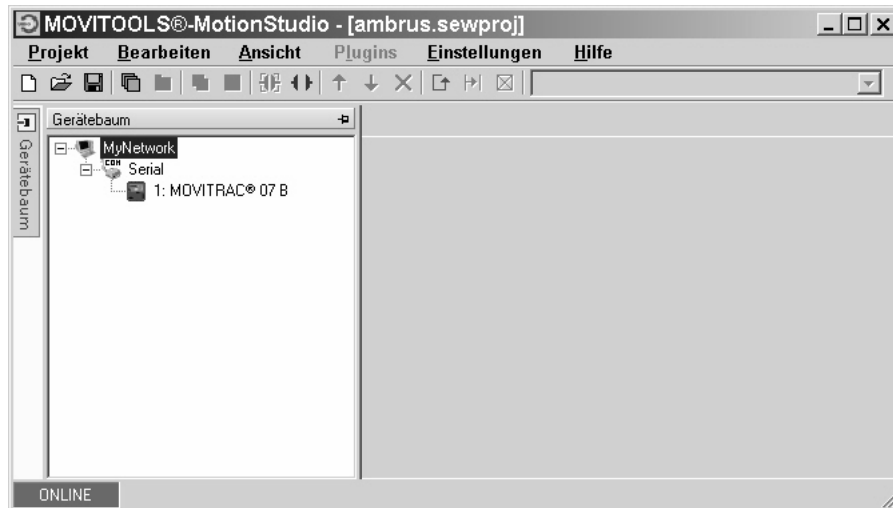

You can perform a startup by right-clicking on one of the units. You find additional information in the online help.

kVA	n
	f
i	
P	Hz

Startup

Startup of explosion-proof AC asynchronous motors of category 2 (94/9/EC)

5.10 Startup of explosion-proof AC asynchronous motors of category 2 (94/9/EC)

Explosion-proof AC motors from SEW-EURODRIVE that are taken into operation with MOVITRAC® B must be approved for such operation according to the nameplate and EC type examination certificate.

A certified safety function is used in conjunction with temperature sensors in the motor to provide for a safe operation in potentially explosive areas. The current limitation function in MOVITRAC® B prevents the activation of the safety device, i.e. the motor is protected against impermissible overheating (→ following figure).

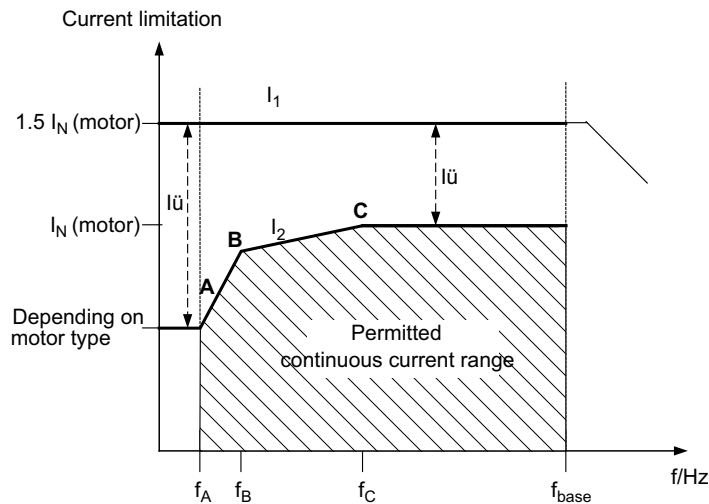

Use the MOVITOOLS® MotionStudio software for startup. During startup, parameters P560 – P566 are automatically activated for SEW motors selected and approved for Ex-e operation.

After startup, P560 can only be activated if a motor approved for Ex-e operation has been started up before.

After motor startup, current limitation I_1 is active. Current limitation I_2 determines the permanently permitted current (shaded area)

You can document the startup parameters and values with MOVITOOLS® MotionStudio. They are displayed in the "ATEX information" window.

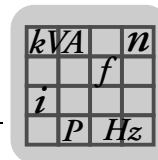

5.11 Starting the motor

You have to exit manual operation before you can enable the motor via terminals.

5.11.1 Analog setpoint specification

The following table shows which signals must be present on terminals X11:2 (AI1) and X12:1 – X12:4 (DIØØ – DIØ3) when the "unipolar/fixed setpoint" setpoint is selected (P100) in order to operate the drive with an analog setpoint entry.

Function	X11:2 (AI1) Analog input n1	X12:1 (DIØØ) /Control- ler inhibit ¹⁾	X12:2 (DIØ1) CW/halt	X12:3 (DIØ2) CCW/ halt	X12:4 (DIØ3) Enable/ stop	X12:5 (DIØ4) n11/n21	X12:6 (DIØ5) n12/n22
Controller inhibit	X	0	X	X	X	0	0
Stop	X	1	X	X	0	0	0
Enable and halt	X	1	0	0	1	0	0
Clock- wise at 50 % n_{max}	5 V	1	1	0	1	0	0
Clock- wise with n_{max}	10 V	1	1	0	1	0	0
Counter- clockwise with 50 % n_{max}	5 V	1	0	1	1	0	0
Counter- clockwise with n_{max}	10 V	1	0	1	1	0	0

1) No default setting

0 = 0 signal

1 = 1 signal

X = Not relevant

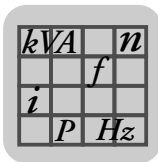

Startup

Starting the motor

The following travel cycle shows by way of example how the motor is started with the assignment of terminals X12:1 – X12:4 and analog setpoints. Binary output X10:3 (DBØØ "/Brake") is used for switching brake contactor K12.

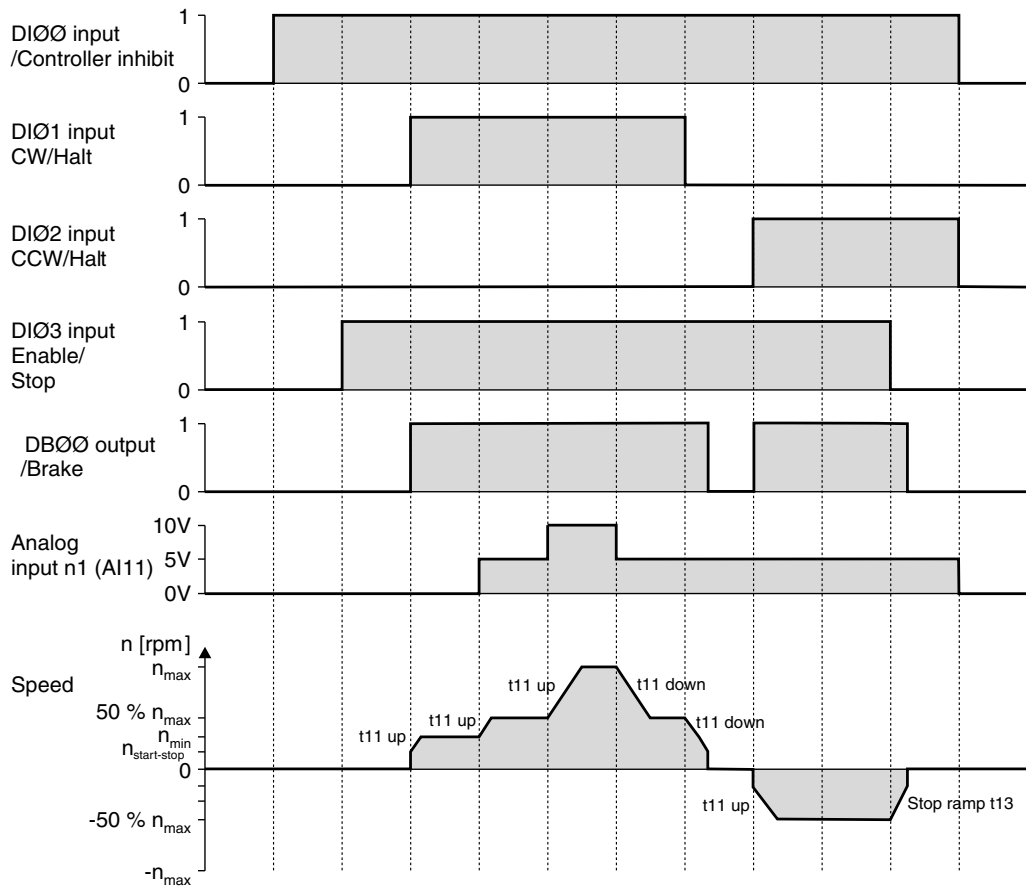

TIP

The motor is not energized in the event of controller inhibit. A motor without brake will coast to standstill.

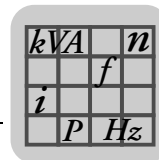

5.11.2 Fixed setpoints

The following table shows which signals must be present on terminals X12:1 – X12:6 (DIØØ – DIØ5) when the "unipolar/fixed setpoint" setpoint is selected (P100) in order to operate the drive with the fixed setpoints.

Function	X12:1 (DIØØ) /Control- ler inhibit	X12:2 (DIØ1) CW/halt	X12:3 (DIØ2) CCW/halt	X12:4 (DIØ3) Enable/stop	X12:5 (DIØ4) n11/n21	X12:6 (DIØ5) n12/n22
Controller inhibit	0	X	X	X	X	X
Stop	1	X	X	0	X	X
Enable and stop	1	0	0	1	X	X
CW operation with n11	1	1	0	1	1	0
CW operation with n12	1	1	0	1	0	1
CW operation with n13	1	1	0	1	1	1
CCW operation with n11	1	0	1	1	1	0

0 = 0 signal
1 = 1 signal
X = Not relevant

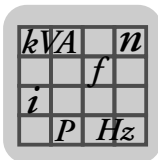

Startup

Starting the motor

The following travel cycle shows by way of example how the drive is started with the assignment of terminals X12:1 – X12:6 and the internal fixed setpoints. Binary output X10:3 (DBØØ "/Brake") is used for switching brake contactor K12.

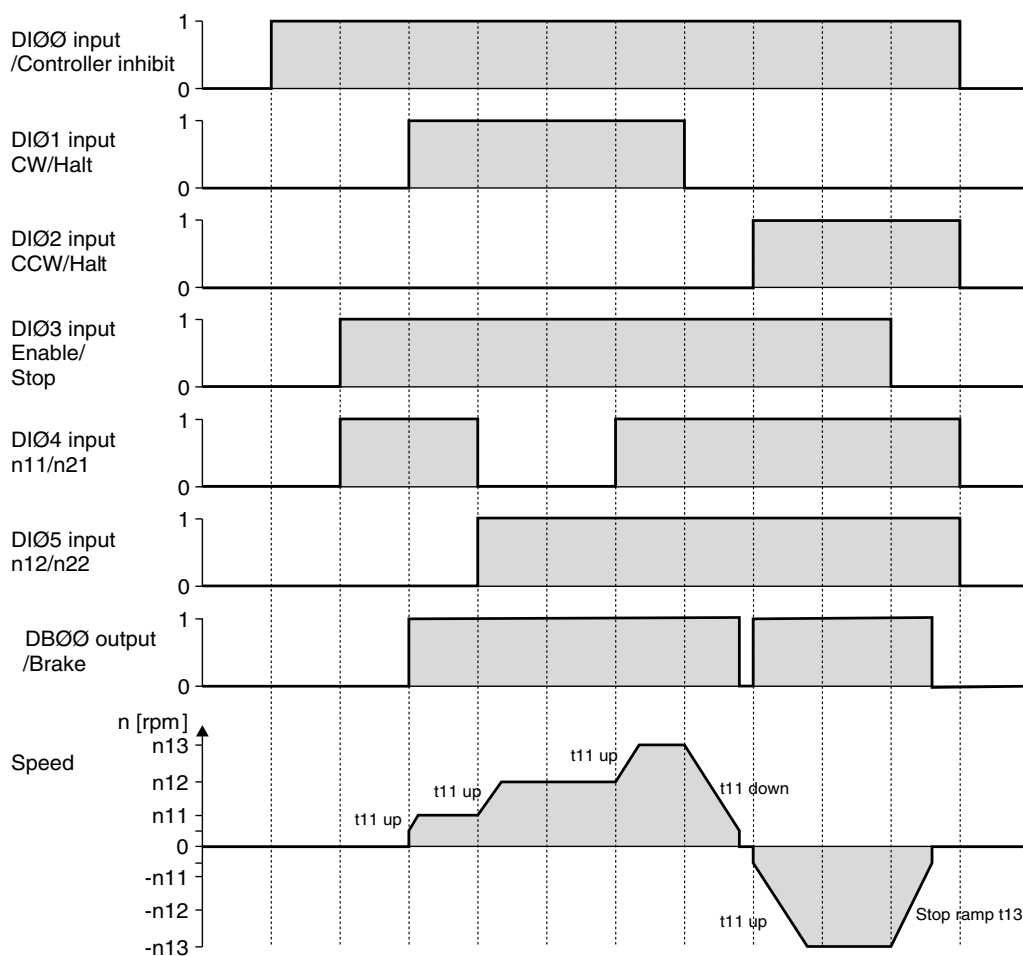



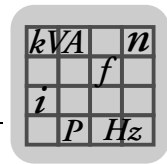

TIP

The motor is not energized in the event of controller inhibit. A motor without brake will coast to standstill.











5.12 Parameter list

All parameters that can also be displayed and edited using the keypad are indicated as follows in the "FBG" (keypad) column:

-  Selection in long menu
-  Selection in short or long menu
-  Selection using symbol on keypad and in long menu
-  Selection within FGB motor startup

If a choice is offered, the factory setting is indicated in **bold**.

No.	FBG	Index dec.	Name	Range / factory setting		Value after startup
				Display	MOVITOOLS® MotionStudio	
0..			Display values (read only)			
00.			Process values			
000		8318	Speed (signed)		[rpm]	
001		8501	User display for DBG11B		[Text]	
002		8319	Frequency (signed)		[Hz]	
004		8321	Output current (value)		[% I _N]	
005		8322	Active current (signed)		[% I _N]	
008		8325	DC link voltage		[V]	
009		8326	Output current		[A]	
01.			Status displays			
010		8310	Inverter status		[Text]	
011		8310	Operating state		[Text]	
012		8310	Error status		[Text]	
013		8310	Current parameter set		Current parameter set	
014		8327	Heat sink temperature		[°C]	
02.			Analog setpoints			
020		8331	Analog input AI1		[V]	
021		8332	Analog input AI2 (optional)		[V]	
03.			Binary inputs			
030		8844	Binary input DI00		Error reset	
031		8335	Binary input DI01		CW / halt (fixed assignment)	
032		8336	Binary input DI02		CCW/halt	

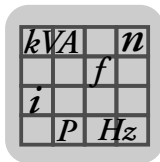

No.	FBG	Index dec.	Name	Range / factory setting		Value after startup	
				Display	MOVITOOLS® MotionStudio		
033		8337	Binary input DI03		Enable/stop		
034		8338	Binary input DI04		n11/n21		
035		8339	Binary input DI05		n12/n22		
039	Long	8334	Binary inputs DI00 – DI05		Collective display of binary inputs		
04.			Binary inputs option				
040			Binary input DI10		No function		
041			Binary input DI11		No function		
042			Binary input DI12		No function		
043			Binary input DI13		No function		
044			Binary input DI14		No function		
045			Binary input DI15		No function		
046			Binary input DI16		No function		
048	Long	8348	Binary inputs DI10 – DI15		Collective display of binary inputs		
05.			Binary outputs				
051		8349	Binary output DO01		/fault		
052		8349	Binary output DO02		Brake released		
053		8349	Binary output DO03		Ready		
059	Long	8349	Binary outputs DO01 – DO03		Collective display of binary outputs		
07.			Unit data				
070		8301	Unit type		[Text]		
071		8361	Rated output current		[A]		
076		8300	Firmware of basic unit		[Part number and version]		
077		–	DBG firmware		Only in DBG60B		
08.			Fault memory				
080 – 084	Long	8366 – 8370	Fault t-0 – t-4	Fault code	Background information for previous faults.		
09.			Bus diagnostics				
094		8455	PO 1 setpoint		[hex]		
095	Long	8456	PO 2 setpoint		[hex]		
096		8457	PO 3 setpoint		[hex]		
097		8458	PI 1 actual value		[hex]		

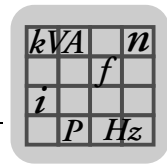

No.	FBG	Index dec.	Name	Range / factory setting		Value after startup
				Display	MOVITOOLS® MotionStudio	
098		8459	PI 2 actual value		[hex]	
099		8460	PI 3 actual value		[hex]	
1..			Setpoints / ramp generators (on FBG only parameter set 1)			
10.			Setpoint selection / frequency input			
100		8461	Setpoint source	0 1 2 4 6 7 8 9 10 11 14	Bipolar / fixed setpoint Unipolar / fixed setpoint RS-485 / fixed setpoint Motor potentiometer/fixed setpoint Fixed setpoint + AI1 Fixed setpoint* + AI1 MASTER SBus1 MASTER RS-485 SBus 1 / Fixed setpoint Frequency setpoint input / Fixed setpoint Bipolar AI2 / Fixed setpoint	
101	Short	8462	Control signal source	0 1 3 4	Terminals RS-485 SBus 1 3-wire control	
102		8840	Frequency scaling	0.1 – 10 – 120.00 [kHz]		
103		10247.15	FI1 reference	0 1	n_{\max} $n_{\text{reference}}$	
104		10247.10	Setpoint reference speed n_{ref}	0 – 3000 – 6000 rpm		
105		10416.1	Wire breakage detection	0 2 4 7	No response Immediate stop/fault Rapid stop/fault Rapid stop/warning	
106		10247.11	FI1 char. curve x1	0 – 100 %		
107		10247.12	FI1 char. curve y1	–100 % – 0 – +100 %		
108	Long	10247.13	FI1 char. curve x2	0 – 100 %		
109		10247.14	FI1 char. curve y2	–100 % – 0 – +100 %		
11.			Analog input 1 (0 – 10 V)			
110		8463	AI1 scaling	0.1 – 1 – 10		
112	Short	8465	AI1 operating mode	1 5 6 7 8 9	10 V, reference maximum speed 0 – 20 mA, reference maximum speed 4 – 20 mA, reference maximum speed 0 – 10 V, n-reference 0 – 20 mA, n-reference 4 – 20 mA, n-reference	
113		8466	AI1 voltage offset	–10 V – 0 – +10 V		
116		10247.6	AI1 characteristic curve x1	0 – 100 %		
117		10247.7	AI1 characteristic curve y1	–100 % – 0 – +100 %		
118		10247.8	AI1 characteristic curve x2	0 – 100 %		
119		10247.9	AI1 characteristic curve y2	–100 % – 0 – +100 %		

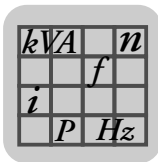

Startup Parameter list

No.	FBG	Index dec.	Name	Range / factory setting		Value after startup
				Display	MOVITOOLS® MotionStudio	
12.			Analog input AI2 / FBG speed control module (option)			
120	LONB	8469	AI2 operating mode	0 1 2	No function 0 – ±10 V + setpoint 0 – 10 V current limit	
121		8811	Addition FBG setpoint control module	0 1 2	Off On On (without fixed setpoint)	
122		8799	Direction of rotation FBG manual operation	0 1 2	Unipolar CW Unipolar CCW Bipolar CW and CCW	
126	LONB	10247.1	AI2 characteristic curve x1	–100 % – 0 – +100 % (–10 V – 0 – +10 V)		
127		10247.2	AI2 characteristic curve y1	–100 % – 0 – +100 % (–n _{max} – 0 – +n _{max} / 0 – I _{max})		
128		10247.3	AI2 char. curve x2	–100 % – 0 – +100 % (–10 V – 0 – +10 V)		
129		10247.4	AI2 char. curve y2	–100 % – 0 – +100 % (–n _{max} – 0 – +n _{max} / 0 – I _{max})		
13. / 14.			Speed ramps 1 / 2			
130 / 140	LONB	8807 / 9264	Ramp t11 / t21 up	0.1 – 2 – 2000 [s]		
131 / 141		8808 / 9265	Ramp t11 / t21 down	0.1 – 2 – 2000 [s]		
134 / 144	LONB	8474 / 8482	Ramp t12 / t22	0.1 – 10 – 2000 [s]		
135 / 145		8475 / 8483	S pattern t12 / t22	0 1 2 3	Off Weak Medium Strong	
136 / 146		8476 / 8484	Stop ramp t13 / t23	0.1 – 2 – 20 [s]		
139 / 149		8928 / 8929	Ramp monitoring 1 / 2	0 1	YES NO	
15.			Motor potentiometer function			
150	LONB	8809	Ramp t3 up = down	0.2 – 20 – 50 [s]		
152		8488	Save last setpoint	Off On	Off On	
16. / 17.			Fixed setpoints			
160 / 170	LONB	8489 / 8492	Internal setpoint n11 / n21	0 – 150 – 5000 [rpm]		
161 / 171		8490 / 8493	Internal setpoint n12 / n22	0 – 750 – 5000 [rpm]		
162 / 172		8491 / 8494	Internal setpoint n13 / n23	0 – 1500 – 5000 [rpm]		
163 / 173		8814 / 8817	n11 / n21 PI controller	0 – 3 – 100 [%]		
164 / 174		8815 / 8818	n12 / n22 PI controller	0 – 15 – 100 [%]		
165 / 175		8816 / 8819	n13 / n23 PI controller	0 – 30 – 100 [%]		

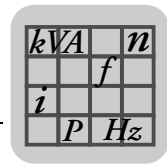

No.	FBG	Index dec.	Name	Range / factory setting		Value after startup
				Display	MOVITOOLS® MotionStudio	
2..						
Controller parameter						
25.						
PI controller						
250		8800	PI controller	0 1 2	Off Normal Inverted	
251		8801	P-gain	0 – 1 – 64		
252		8802	I-component	0 – 1 – 2000 [s]		
253	L on B	8465	PI actual value mode	1 5 6 7 8 9	10 V, reference maximum speed 0 – 20 mA, reference maximum speed 4 – 20 mA, reference maximum speed 0 – 10 V, n-reference 0 – 20 mA, n-reference 4 – 20 mA, n-reference	
254		8463	PI actual value scaling	0.1 – 1.0 – 10.0		
255		8812	PI actual value offset	0.0 – 100.0 [%]		
3..						
Motor parameters (on FBG only parameter set 1)						
30. / 31.						
Limits 1 / 2						
300 / 310		8515 / 8519	Start/stop speed 1 / 2	0 – 150 [rpm]		
301 / 311	L on B	8516 / 8520	Minimum speed 1 / 2	0 – 15 – 5500 [rpm]		
302 / 312		8517 / 8521	Maximum speed 1 / 2	0 – 1500 – 5500 [rpm]		
303 / 313	L on B	8518 / 8522	Current limit 1 / 2	0 – 150 [% I _N]		
32. / 33.						
Motor adjustment 1 / 2						
320 / 330		8523 / 8528	Automatic adjustment 1 / 2	Off On	Off On	
321 / 331		8524 / 8529	Boost 1 / 2	0 – 100 [%]		
322 / 332	L on B	8525 / 8530	IxR compensation 1/2	0 – 100 [%]		
323 / 333		8526 / 8531	Premagnetization time 1 / 2	0 – 2 [s]		
324 / 334		8527 / 8532	Slip compensation 1/2	0 – 500 [rpm]		
34.						
I_N UL monitoring						
345 / 346	L on B	9114 / 9115	I _N UL monitoring 1 / 2	0.1 – 500 A		
4..						
Reference signals						
40.						
Speed reference signals						
400		8539	Speed reference value	0 – 750 – 5000 [rpm]		
401		8540	Hysteresis	0 – 100 – +500 [rpm]		
402	L on B	8541	Delay time	0 – 1 – 9 [s]		
403		8542	Signal = "1" when	0 1	n < n _{ref} n > n _{ref}	

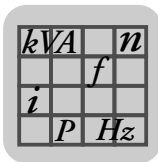

No.	FBG	Index dec.	Name	Range / factory setting		Value after startup
				Display	MOVITOOLS® MotionStudio	
43.			Current reference signal			
430		8550	Current reference value	0 – 100 – 150 % I _N		
431	Lon6	8551	Hysteresis	0 – 5 – 30 % I _N		
432		8552	Delay time	0 – 1 – 9 s		
433		8553	Signal = "1" when	0 1	I < I _{ref} I > I _{ref}	
44.			I_{max} signal			
440		8554	Hysteresis	0 – 5 – 50 % I _N		
441	Lon6	8555	Delay time	0 – 1 – 9 s		
442		8556	Signal = "1" when	0 1	I < I _{max} I > I _{max}	
45.			PI controller reference signal			
450		8813	PI actual value reference	0.0 – 100.0 %		
451	Lon6	8796	Signal = "1" if	0 1	PI Actual value < PI ref PI Actual value > PI ref	
5..			Control functions (on FBG only parameter set 1)			
50.			Speed monitoring 1 / 2			
500 / 502	Lon6	8557 / 8559	Speed monitoring 1 / 2	0 3	Off Motor/regenerative	
501 / 503		8558 / 8560	Delay time 1 / 2	0 – 1 – 10 [s]		
54.			Gear unit/motor monitoring			
540	Lon6	9284	Response to drive vibration / warning		Factory setting: Display error	
541		9285	Response to drive vibration / fault		Factory setting: Rapid stop/warning	
542		9286	Response to oil aging / fault		Factory setting: Display error	
543		9287	Response to oil aging/warning		Factory setting: Display error	
544		9288	Oil aging / over-temperature		Factory setting: Display error	
545		9289	Oil aging / ready signal		Factory setting: Display error	
549		9290	Response to brake wear		Factory setting: Display error	

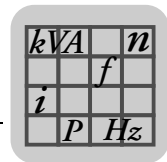

No.	FBG	Index dec.	Name	Range / factory setting		Value after startup
				Display	MOVITOOLS® MotionStudio	
56.			Current limit Ex-e motor:			
560		9293	Current limit Ex-e motor		ON / OFF	
561		9294	Frequency A		0 – 5 – 60 Hz	
562		9295	Current limit A		0 – 50 – 150 %	
563	Long	9296	Frequency B		0 – 10 – 104 Hz	
564		9297	Current limit B		0 – 80 – 200 %	
565		9298	Frequency C		0 – 25 – 104 Hz	
566		9299	Current limit C		0 – 100 – 200 %	
6..			Terminal assignment			
60.			Binary inputs			
601		8336	Binary input DI02 assignment		0: No function 1: Enable / stop (factory setting DI03) 2: CW/halt 3: CCW / halt (factory setting DI02) 4: n11/n21 (factory setting DI04) 5: n12/n22 (factory setting DI05) n13 = n11 + n12 6: Fixed setpoint switchover 7: Parameter set switchover 8: Ramp switchover 9: Motor potentiometer up 10: Motor potentiometer down 11: /External fault 12: Fault reset (factory setting DI00) 19: Slave free running 20: Setpoint acceptance active 26: TF signal (only with DI05) 27: Vibration/warning 28: Vibration/fault 29: Brake wear 30: Controller inhibit 33: Oil aging/warning 34: Oil aging/fault 35: Oil aging / overtemperature 36: Oil aging/ready	
602		8337	Binary input DI03 assignment			
603	Short	8338	Binary input DI04 assignment			
604		8339	Binary input DI05 assignment			
608		8844	Binary input DI00 assignment			
61.			Binary inputs option			
610		8340	Binary input DI10 assignment			
611		8341	Binary input DI11 assignment			
612	Short	8342	Binary input DI12 assignment			
613		8343	Binary input DI13 assignment			
614		8344	Binary input DI14 assignment			
615		8345	Binary input DI15 assignment			
616		8346	Binary input DI16 assignment			

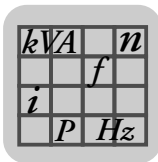

Startup Parameter list

No.	FBG	Index dec.	Name	Range / factory setting		Value after startup
				Display	MOVITOOLS® MotionStudio	
62.			Binary outputs			
620	Short	8350	Binary output DO01 assignment		0: No function 1: /Fault (factory setting DO01)	
621		8351	Binary output DO02 assignment		2: Ready (factory setting DO03) 3: Output stage ON	
622		8916	Binary output DO03 assignment		4: Rotating field ON 5: Brake released (factory setting DO02 / not with DO03) 8: Parameter set 9: Speed reference message 11: Setpoint-actual value comparison signal 12: Current reference signal 13: I _{max} signal 21: IPOS output 22: /IPOS fault 23: PI controller actual value reference 24: Ex-e current limit active (in preparation) 27: Safe stop 30: Ixt warning 31: Ixt fault	
64.			Analog outputs AO1 (optional)			
640	Long	8568	AO1 analog output	0 1 2 3 4 5 6 7 11 12	No function Ramp generator input Setpoint speed Actual speed Actual frequency Output current Active current Unit utilization Actual speed (signed) Actual frequency (signed)	
641		10248.5	AO1 reference	0 1 2	3000 rpm, 100 Hz, 150 % n_{\max} n_{set} reference	
642		8570	AO1 Operating mode	0 2 3 4	No function 0 – 20 mA 4 – 20 mA 0 – 10 V	
646	Long	10246.1	AO1 char. curve x1	–100 % – 0 – +100 %		
647		10246.2	AO1 char. curve y1	0 – 100 %		
648		10246.3	AO1 char. curve x2	–100 % – 0 – +100 %		
649		10246.4	AO1 char. curve y2	0 – 100 %		
7..			Control functions (on FBG only parameter set 1)			
70.			Operating modes 1 / 2			
700 / 701		8574 / 8575	Operating mode 1 / 2	0 2 3 4 21 22	VFC VFC & Hoist VFC & DC braking VFC & flying start function V/f characteristic curve V/f & DC braking	

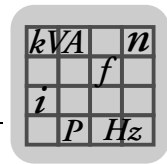

No.	FBG	Index dec.	Name	Range / factory setting		Value after startup
				Display	MOVITOOLS® MotionStudio	
71.			Standstill current 1 / 2			
710 / 711	Long	8576 / 8577	Standstill current 1 / 2	0 – 50 % I _{Mot}		
72.			Setpoint stop function 1 / 2			
720 / 723		8578 / 8581	Setpoint stop function 1 / 2	Off On	Off On	
721 / 724	Long	8579 / 8582	Stop setpoint 1 / 2	0 – 30 – 500 [rpm]		
722 / 725		8580 / 8583	Start offset 1 / 2	0 – 30 – 500 [rpm]		
73.			Brake function 1 / 2			
731 / 734	Long	8749 / 8750	Brake release time 1 / 2	0 – 2 [s]		
732 / 735	Long	8585 / 8587	Brake application time 1 / 2	0 – 2 [s]		
74.			Speed skip function			
740 / 742	Long	8588 / 8590	Skip window center 1 / 2	0 – 1500 – 5000 rpm		
741 / 743	Long	8589 / 8591	Skip width 1 / 2	0 – 300 rpm		
75.			Master/slave function			
750	Long	8592	Slave setpoint			
751	Long	8593	Scaling slave setpoint			
76.			Manual operation			
760	Long	8798	Lock RUN/STOP keys	Off On	Off On	
77.			Energy-saving function			
770	Long	8925	Energy-saving function	Off On	Off On	
8..			Unit functions (on FBG only parameter set 1)			
80.			Setup			
800		–	Quick menu	long short		
801		–	DBG language			
802	Short	8594	Factory setting	No Hours ALL NEMA	0 / No 1 / Standard 2 / Delivery status 4 / NEMA delivery status	
803		8595	Parameter lock	Off On	Off On	
804		8596	Reset statistics data		No action Fault memory	
805		–	Rated mains voltage		50 – 500 V	
806		–	Copy DBG → MOVITRAC® B		Yes No	

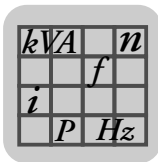

Startup Parameter list

No.	FBG	Index dec.	Name	Range / factory setting		Value after startup
				Display	MOVITOOLS® MotionStudio	
807		–	Copy MOVITRAC® B → DBG		Yes No	
808		8660	24 V output voltage		Off On	
809		10204.1	IPOS enable		Off On	
81.			Serial communication			
810	Long	8597	RS-485 address	0 – 99		
811		8598	RS-485 group address	100 – 199		
812		8599	RS-485 timeout interval	0 – 650 [s]		
82.			Brake operation 1 / 2			
820 / 821		8607 / 8608	4-quadrant operation 1 / 2	Off On	Off On	
83.			Error responses			
830		8609	Response terminal "external fault"	2 4	Immediate stop / fault Rapid stop / fault (830) Rapid stop / warning (833 / 836)	
833	Long	8612	Response to RS-485 timeout	7		
836		8615	Response to SBus timeout			
84.			Reset behavior			
840		8617	Manual reset		Yes No	
841		8618	Auto reset		Off On	
842		8619	Restart time		1 – 3 – 30 s	
85.			Scaling actual speed value			
850		8747	Scaling factor numerator	1 – 65535 (can be set with SHELL only)		
851		8748	Scaling factor denominator	1 – 65535 (can be set with SHELL only)		
852	Long	8772 / 8773	User-defined unit	Text		
853		9312	Scaled speed FBG	0 1	Speed Scaled speed	
86.			Modulation 1 / 2			
860 / 861	Long	8620 / 8621	PWM frequency 1 / 2	4 8 12 16	4 kHz 8 kHz 12 kHz 16 kHz	
862 / 863		8751 / 8752	PWM fix 1 / 2	On Off	On Off	

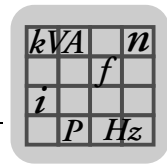

No.	FBG	Index dec.	Name	Range / factory setting		Value after startup
				Display	MOVITOOLS® MotionStudio	
87.			Process data parameter setting			
870	LonB	8304	Setpoint description PO1		No function (factory setting P872) Setpoint speed (factory setting P871) Max. speed Ramp Control word 1 (factory setting P870) Control word 2 Setpoint speed [%] IPOS PO data PI controller setpoint [%]	
871		8305	Setpoint description PO2			
872		8306	Setpoint description PO3			
873		8307	Actual value description PI1		No function Actual speed (factory setting P874) Output current (factory setting P875) Active current Status word 1 (factory setting P873) Actual speed [%] IPOS PI-DATA PI controller actual value [%]	
874		8308	Actual value description PI2			
875		8309	Actual value description PI3			
876	LonB	8622	Enable PO data		No Yes	
88.			Serial communication SBus			
880	LonB	8937	SBus protocol	0 / MoviLink 1 / CANopen		
881		8600	SBus address	0 – 63		
882		8601	SBus group address	0 – 63		
883		8602	SBus timeout interval	0 – 650 [s]		
884	LonB	8603	SBus baud rate	125 250 500 1000	125 kBd 250 kBaud 500 kBaud 1 MBaud	
886		8989	CANopen address	1 – 2 – 127		

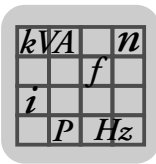

6 Operation

6.1 Data backup

6.1.1 Data backup using FBG11B

Use the FBG11B keypad to download parameter data from the MOVITRAC® B to the keypad or copy from the keypad to MOVITRAC® B.

After copying the parameters, check them for accuracy.

Data backup using FBG11B

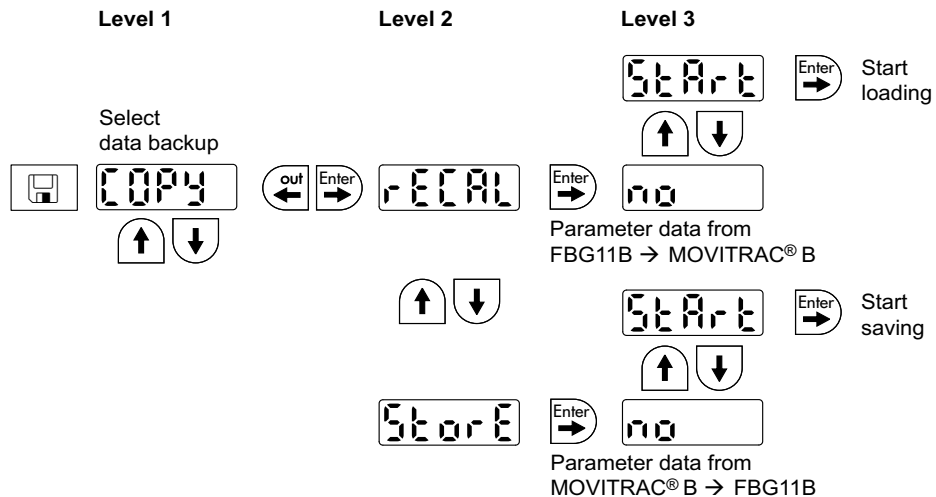

After copying data, the MOVITRAC® B is inhibited. The inhibited status is indicated by a flashing STOP in the status display. The status LED also slowly flashes yellow.

You can revoke the inhibit by taking one of the following measures:

- Pressing the RUN button on the FBG11B.
- Switching the mains off, waiting 10 seconds, and switching the mains back on.

6.1.2 Data backup using DBG60B

Copy the parameter set from MOVITRAC® B to the DBG60B keypad. You have the following options:

- In the context menu, select the "COPY TO DBG" menu item. Confirm your selection by pressing OK. The parameter set is copied from MOVITRAC® B to DBG60B.
- In the context menu, select the "PARAMETER MODE" menu item. Select parameter P807 "MCB → DBG". The parameter set is copied from MOVITRAC® B to DBG60B.

6.1.3 Data backup using UBP11A

Copy the parameter set from MOVITRAC® B to the UBP11A parameter module. To do so, press the button at the lower end of the module. You need a pointed object for this purpose.

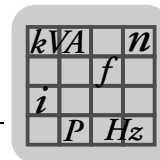

6.1.4 Data backup using MOVITOOLS® MotionStudio

When you use MOVITOOLS® MotionStudio to transfer data to the MOVITRAC® B frequency inverter, you must re-enable the inverter as follows:

- Select the unit in the network.
- Open the context menu with a right mouse click
- Select menu [RUN/STOP via software keypad] [1]
- Select [RUN] in the software keypad [2]

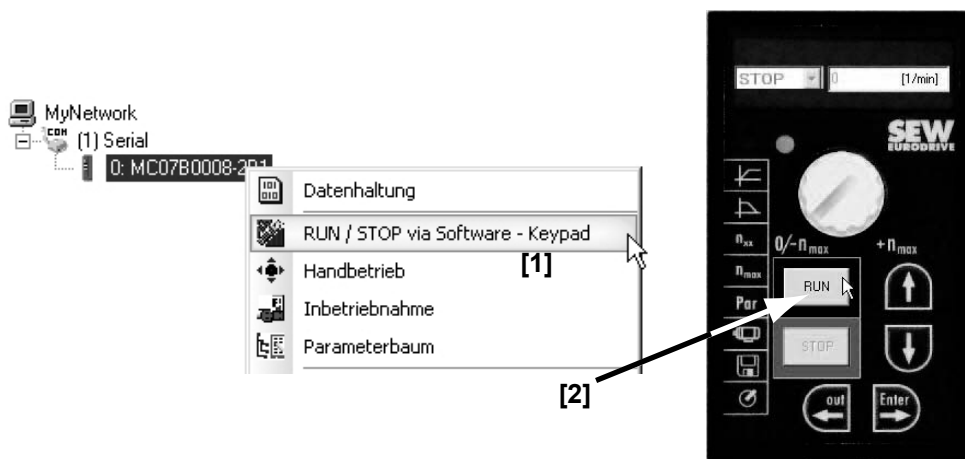

6.2 Return codes (r-19 – r-38)

Return codes MOVITRAC® B:

No.	Designation	Meaning
19	Parameter lock activated	Parameters cannot be changed
20	Factory setting in progress	Parameters cannot be changed
23	Option card missing	The option card required for the function is missing.
27	Option card missing	The option card required for the function is missing.
28	Controller inhibit required	Controller inhibit required
29	Invalid value for parameter.	<ul style="list-style-type: none"> • Invalid value for parameter. • FGB manual operation selection invalid as PC is in active manual operation.
32	Enable	You cannot perform this function in ENABLED status
34	Error during execution	<ul style="list-style-type: none"> • Error while saving in FBG11B. • Startup not performed with FBG. Perform FGB startup with MotionStudio or select a new motor.
38	FBG11B incorrect data set	Stored data set does not match the unit

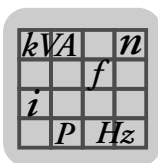

6.3 Status displays

6.3.1 FBG11B keypad

If the status is "Drive enabled", the display will show the calculated actual speed.

Status	Display
Drive "Controller inhibit"	oFF
Drive "No enable"	StoP
Drive "Enable"	8888 (actual speed)
Factory setting	SEt (Set)
Standstill current	dc
24 V operation	24U

Status of binary inputs / outputs

Parameter P039 (binary inputs of basic unit), parameter P059 (binary outputs of option), and parameter P059 (binary outputs) are available as display parameters in the parameter menu. The status is displayed as binary. Every binary input or output has two segments vertically on top of one another of the 7-segment display assigned to it. The upper segment lights up when the binary input or output is set, and the lower segment lights up when the binary input or output is not set. The two 7-segment displays on the right indicate whether P039 (di = binary inputs basic unit), P048 (di = binary inputs option), or P059 (do = binary outputs) are output.

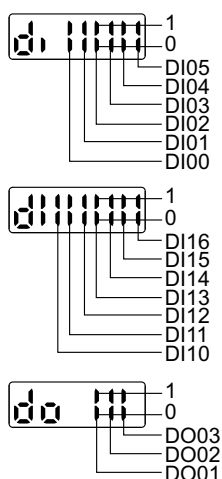

If no FIO21B with binary inputs is available, the display will show di - - -.

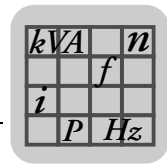

6.3.2 LED flash codes

The LED on the front of the unit signals the following states:

Status	Display (optional with FBG)	LED flash code status of basic unit
"ENABLE"	Speed	Constant green light
"ENABLE" at current limit	Speed flashes	Rapid green flashing
"CURRENT AT STAND-STILL"	dc	Slow green flashing
Timeout	Faults 43 / 46 / 47	Flashing green/yellow
"NO ENABLE"	Stop	Constant yellow light
"FACTORY SETTING"	SEt	Rapid yellow flashing
"CONTROL.INHIBIT"	oFF	Rapid yellow flashing
"24 V operation"	Flashing 24U	Slow yellow flashing
"SAFE STOP"	Flashing U	Slow yellow flashing
FGB manual operation active or inverter stopped using "stop" button.	FGB manual operation symbol or "stop" is flashing	Yellow on long, off briefly
Copy	Fault 97	Flashing red/yellow
System fault	Faults 10 / 17 ... 24 / 25 / 32 / 37 / 38 / 45 / 77 / 80 / 94	Constant red light
Overvoltage / phase failure	Faults 4 / 6 / 7	Slow red flashing
Overload	Faults 1 / 3 / 11 / 44 / 84	Rapid red flashing
Monitoring	Faults 8 / 26 / 34 / 81 / 82	2 x red flashing
Motor protection	Faults 31 / 84	3 x red flashing



! WARNING

Incorrect interpretation of display U = "Safe stop" active.

Severe or fatal injuries.

The display U = "Safe stop" is not safety-related and must not be used as a safety function.

6.4 Unit status codes

Use status word 1 to determine the unit status code.

Code	Meaning
0x0	Not ready
0x1	Controller inhibit
0x2	No enable
0x3	Standstill current active, no enable
0x4	Enable
0x8	Factory setting is active

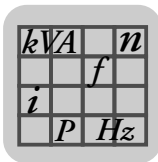

7 Service / List of Faults

7.1 Unit information

7.1.1 Fault memory

The inverter stores the error message in fault memory P080. The inverter does not save a new fault until the error message has been acknowledged. The local operating panel shows the most recent fault. Whenever double faults occur, the value stored in P080 does not correspond to the value displayed on the operating panel. This is an example of what happens with F-07 DC link overvoltage followed by F34 Ramp timeout.

The inverter stores the following information when a malfunction occurs:

- Error occurred
- Status of the binary inputs / binary outputs
- Operating status of the inverter
- Inverter status
- Heat sink temperature
- Speed
- Output current
- Active current
- Unit utilization
- DC link voltage

7.1.2 Switch-off responses

There are 3 switch-off responses depending on the fault:

Immediate switch-off

This fault response causes immediate locking of the output stage with simultaneous control of the brake output so that an existing brake is applied. The "fault message" is set and the "ready message" is revoked.

This status can only be exited by an explicit fault reset.

Stop

This fault response causes a stop at the set stop ramp (P136 / P146). This fault stop is subject to time monitoring. If the drive does not reach the start / stop speed within a specified time period, the unit goes to the fault state, the output stage is inhibited and an existing brake is applied. The fault message "F34 Ramp timeout" is generated. The original fault message is overwritten. If the drive reaches the start/stop speed, the unit goes to the fault state, the brake is applied and the output stage is inhibited. The "fault message" is set and the "ready message" is revoked.

This status can only be exited by an explicit fault reset.

Timeout (warning)

If the inverter is controlled via a communication interface (RS-485 or SBus) and the mains power was switched off and back on again, the enable remains ineffective until the inverter once again receives valid data via the interface, which is monitored with a timeout.

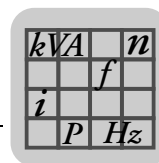

7.1.3 Reset

Reset basic unit

An error message can be acknowledged by:

- Reset via input terminals with an appropriately assigned binary input (DI00, DI02...DI05). Factory setting for DI00 is fault reset.

Reset keypad

An error message can be acknowledged by:

- Manual reset on the keypad (STOP/RESET key).

The "STOP/RESET" key has priority over a terminal enable or an enable via the interface.

The STOP/RESET key can be used for performing a reset after a fault has occurred with a programmed error response. A reset inhibits the drive. To enable the drive, press the RUN key.

Interface reset

An error message can be acknowledged by:

- Manual reset in MOVITools® MotionStudio / P840 Manual reset = Yes, or in the status window of the reset button.

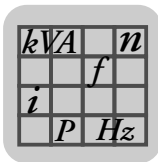
7.2 List of faults (F-00 – F-113)

No.	Designation	Response	Possible cause	Measure
00	No error			
01	Overcurrent	Immediate switch-off with inhibit	• Short circuit on output	• Rectify the short circuit
			• Switching on output	• Switching with inhibited output stage only
			• Motor too large	• Connect a smaller motor
			• Faulty output stage	• Consult SEW Service if the error cannot be reset
03	Ground fault	Immediate switch-off with inhibit	• Ground fault in motor	• Replace motor
			• Ground fault in inverter	• Replace MOVITRAC® B
			• Ground fault in the motor supply lead	• Eliminate ground fault
			• Overcurrent (see F-01)	• See F-01
04	Brake chopper	Immediate switch-off with inhibit	• Too much regenerative power	• Extend deceleration ramps
			• Braking resistor circuit interrupted	• Check supply cable to the braking resistor
			• Short circuit in the braking resistor circuit	• Rectify the short circuit
			• Brake resistor resistance too high	• Check technical data of braking resistor
			• Brake chopper defective	• Replace MOVITRAC® B
			• Ground fault	• Eliminate ground fault
06	Mains phase failure	Immediate switch-off with inhibit (only with 3-phase inverter)	• Phase failure	• Check the power supply cable
			• Supply voltage too low	• Check the supply voltage
07	DC link overvoltage	Immediate switch-off with inhibit	• DC link voltage too high	• Extend deceleration ramps • Check supply cable to the braking resistor • Check technical data of braking resistor
			• Ground fault	• Eliminate ground fault
08	Speed monitoring	Immediate switch-off with inhibit	Current controller works at the set limit due to:	
			• Mechanical overload	• Reduce load • Check current limitation • Extend deceleration ramps • Increase P501 deceleration time setting ¹⁾
			• Phase failure in supply system	• Check mains phases
			• Phase failure in motor	• Check motor cable and motor
			• Maximum speed for VFC operating modes exceeded	• Reduce maximum speed
09	Startup	Immediate switch-off with inhibit	• Inverter not started yet	• Start up the inverter
			• Unknown motor selected	• Select another motor

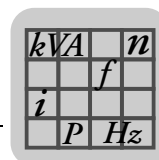

No.	Designation	Response	Possible cause	Measure
10	IPOS-ILLOP	Stop with inhibit with IPOS only	• Wrong command during program execution	• Check the program
			• Incorrect conditions during program execution.	• Check program run
			• Function does not exist / is not implemented in the inverter	• Use another function
11	Over-temperature	Stop with inhibit	• Thermal overload of inverter	<ul style="list-style-type: none"> • Reduce load and/or ensure adequate cooling • If a braking resistor is integrated in the heat sink: Install braking resistor externally
17 ... 24	System malfunction	Immediate switch-off with inhibit	• Inverter electronics is faulty, possibly due to EMC influence	<ul style="list-style-type: none"> • Check grounding and shielding and improve, if necessary. • Contact SEW Service for advice if this fault reoccurs.
25	EEPROM	Stop with inhibit	• Fault while accessing EEPROM	<ul style="list-style-type: none"> • Activate factory settings, perform reset and reset parameters. • Contact SEW Service for advice if this fault reoccurs.
26	External terminal	Programmable	• Read in external fault signal via programmable input	• Eliminate respective cause; reprogram terminal if necessary.
31	TF/TH sensor tripped	Stop with inhibit	• Motor too hot, TF sensor has tripped	• Let motor cool off and reset error
			<ul style="list-style-type: none"> • TF sensor of motor not connected or connected incorrectly • Connection of MOVITRAC® B and TF on motor interrupted 	• Check connections / links between MOVITRAC® B and TF
32	IPOS index overflow	Stop with inhibit	• Programming principles violated leading to internal stack overflow	• Check user program and correct it
34	Ramp timeout	Immediate switch-off with inhibit	• Set ramp time exceeded	• Extend the ramp time
			• If you remove the inhibit and the drive exceeds the stop ramp time t13 by a certain time, the inverter will signal F34.	• Extend the stop ramp time
35	Ex-e protection operating mode	Programmable	• Wrong operating mode selected	<ul style="list-style-type: none"> • Permitted modes: <ul style="list-style-type: none"> • V/f, VFC, VFC hoist • Non-permitted modes: <ul style="list-style-type: none"> • Flying start function • DC braking • Group operation
			• Non-permitted parameter set	• Use parameter set 1 only
			• No Ex-e motor taken into operation	• Take Ex-e motor into operation
			• Incorrectly parameterized frequency points	<ul style="list-style-type: none"> • Frequency A < frequency B • Frequency B < frequency C
• Current limits not set correctly	<ul style="list-style-type: none"> • Current limit A < current limit B • Current limit B < current limit C 			

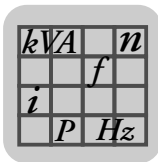

Service / List of Faults

List of faults (F-00 – F-113)

No.	Designation	Response	Possible cause	Measure
36	Option missing	Immediate switch-off with inhibit	• Type of option card not allowed	• Use correct option card
			• Setpoint source, control signal source or operating mode not permitted for this option card	• Set correct setpoint source • Set correct control signal source • Set the correct operating mode • Check parameters P120 and P121
			• Required option missing	• Check the following parameters: • P121 for FBG11B • P120 and P642 for FIO12B
37	System watchdog	Immediate switch-off with inhibit	• Fault in system software sequence	• Check grounding and shielding and improve, if necessary. • Contact SEW Service for advice if this fault reoccurs.
38	System software	Immediate switch-off with inhibit	• System malfunction	• Check grounding and shielding and improve, if necessary. • Contact SEW Service for advice if this fault reoccurs.
43	RS-485 timeout	Stop without inhibit ²⁾	• Connection between inverter and PC interrupted	• Check connection between inverter and PC
44	Unit utilization	Immediate switch-off with inhibit	• Unit utilization (Ixt value) exceeded	• Decrease power output • Extend ramps • If mentioned points not possible: Use a larger inverter
45	Initialization	Immediate switch-off with inhibit	• Error during initialization	• Contact SEW Service for advice
47	System bus 1 timeout	Stop without inhibit	• Fault during communication via system bus	• Check system bus connection
77	IPOS control word	Stop with inhibit	• System malfunction	• Contact SEW Service for advice
80	RAM test	Immediate disconnection	Internal unit fault, RAM defective.	Contact SEW Service
81	Start condition	Immediate switch-off with inhibit	Only in "VFC hoist" operating mode: The motor could not be supplied with the correct amount of current during the pre-magnetizing time:	
			• Rated motor power too small in relation to rated inverter power	• Check connection between inverter and motor • Check startup data and perform new startup, if necessary
			• Motor cable cross section too small	• Check cross section of motor cable and increase if necessary
82	Open output	Immediate switch-off with inhibit	Only in "VFC hoist" operating mode:	
			• 2 or all output phases interrupted	• Check connection between inverter and motor
			• Rated motor power too small in relation to rated inverter power	• Check startup data and perform new startup, if necessary

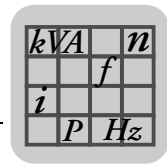

No.	Designation	Response	Possible cause	Measure
84	Motor protection	Stop with inhibit	<ul style="list-style-type: none"> Motor utilization too high 	<ul style="list-style-type: none"> Check P345/346 I_N UL monitoring Reduce load Extend ramps Longer pause times
94	EEPROM checksum	Immediate switch-off with inhibit	<ul style="list-style-type: none"> Defective EEPROM 	<ul style="list-style-type: none"> Contact SEW Service
97	Copy error	Immediate switch-off with inhibit	<ul style="list-style-type: none"> Parameter module is removed during copying process Switching off/on during copying process 	Prior to confirming the error: <ul style="list-style-type: none"> Load factory setting or complete data set from parameter module
98	CRC error flash	Immediate disconnection	Internal unit fault Flash memory defective	Send unit in for repair
100	Vibration / warning	Display error	Vibration sensor warning (→ "DUV10A" operating instructions)	Determine cause of vibrations. Continue operation until F101 occurs.
101	Oscillation fault	Rapid stop	Vibration sensor signals fault	SEW-EURODRIVE recommends that you remedy the cause of the vibrations immediately
102	Oil aging / warning	Display error	Oil aging sensor warns	Schedule oil change
103	Oil aging/fault	Display error	Oil aging sensor signals fault	SEW-EURODRIVE recommends that you change the gear unit oil immediately.
104	Oil aging / over-temperature	Display error	Oil aging sensor signals over-temperature	<ul style="list-style-type: none"> Let oil cool down Check if the gear unit cools properly
105	Oil aging / ready signal	Display error	Oil aging sensor is not ready for operation	<ul style="list-style-type: none"> Check voltage supply of oil aging sensor Check and, if necessary, replace the oil aging sensor
106	Brake wear	Display error	Brake lining worn down	Replace brake lining (→ "Motors" operating instructions)
110	"Ex-e protection" fault	Stop with inhibit	Duration of operation below 5 Hz exceeded	<ul style="list-style-type: none"> Check project planning Shorten duration of operation below 5 Hz
113	Analog input open circuit	programmable	A11 analog input open circuit	<ul style="list-style-type: none"> Check the wiring
116	"Timeout MOVI-PLC" fault	Rapid stop/warning	MOVI-PLC® communication time-out	<ul style="list-style-type: none"> Check startup Check wiring

- Speed monitoring is set by changing parameters 500 / 502 and 501 / 503. The sagging of hoists cannot be avoided safely when monitoring is deactivated or the delay time is set too long.
- No reset required, error message disappears after communication is reestablished

7.3 SEW electronics service

7.3.1 Hotline

Call the Drive Service Hotline to talk to an SEW-EURODRIVE service specialist on 365 days a year, 24 hours a day.

Simply dial the prefix **01805** and then enter the key combination **SEWHELP**. Or simply dial **018057394357**.

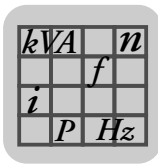

7.3.2 Sending in for repair

Please contact the **SEW Electronics Service** if you cannot rectify a fault.

Please always specify the unit status code number when you contact the SEW electronics service so that our service personnel can assist you more effectively.

Provide the following information when sending the unit in for repair:
Serial number (→ nameplate)
Unit designation
Short description of application (application, control via terminals or serial)
Connected motor (motor voltage, star or delta connection)
Nature of the fault
Accompanying circumstances
Your own presumptions as to what has happened
Unusual events preceding the problem

7.4 Extended storage

If the unit is being stored for a long time, connect it to the mains voltage for at least 5 minutes every 2 years. Otherwise, the unit's service life may be reduced.

Procedure when maintenance has been neglected:

Electrolytic capacitors are used in the inverters. They are subject to aging effects when deenergized. This effect can damage the electrolytic capacitors if the unit is connected using the rated voltage after a longer period of storage.

If you have not performed maintenance regularly, SEW-EURODRIVE recommends that you increase the line voltage slowly up to the maximum voltage. This can be done, for example, by using a variable transformer for which the output voltage has been set according to the following overview. SEW-EURODRIVE recommends that you increase the voltage from 0 V to the first stage after a few seconds.

SEW-EURODRIVE recommends the following stages:

AC 400/500 V units:

- Stage 1: AC 350 V for 15 minutes
- Stage 2: AC 420 V for 15 minutes
- Stage 3: AC 500 V for 1 hour

AC 230 V units:

- Stage 1: AC 170 V for 15 minutes
- Stage 2: AC 200 V for 15 minutes
- Stage 3: AC 240 V for 1 hour

After you have completed the regeneration process, the unit can be used immediately or stored again for an extended period with maintenance.

kVA	n
	f
i	
P	Hz

8 Technical Data

8.1 CE marking, UL approval and C-Tick

8.1.1 CE-marking

MOVITRAC[®] B frequency inverters comply with the regulations of the Low Voltage Directive 73/23/EEC.



MOVITRAC[®] B frequency inverters are designed for use as components for installation in machines and systems. They comply with the EMC product standard EN 61800-3 *Variable-speed electrical drives*. Provided the installation instructions are complied with, they satisfy the relevant requirements for the CE marking for the entire machine/system in which they are installed, on the basis of the EMC Directive 89/336/EEC. For detailed information on EMC compliant installation, refer to the publication "Electromagnetic Compatibility in Drive Engineering" from SEW-EURODRIVE.

Compliance with limit classes C2 and C1 has been tested on a specified test setup. SEW-EURODRIVE can provide detailed information on request.

The CE mark on the nameplate indicates conformity with the low voltage directive 73/23/EEC. We can provide a declaration of conformity on request.

8.1.2 UL approval / CSA / GOST-R certificate / C-Tick



UL and cUL approval (USA) has been granted for the following MOVITRAC[®] B units:

- 230 V / single-phase
- 230 V / 3-phase
- 400/500 V / 3-phase (0.25 – 45 kW / 0.34 – 60 HP)



cUL approval has been applied for the other units. cUL is equivalent to CSA approval.

The GOST-R certificate (Russia) was granted for the MOVITRAC[®] B unit series.



C-Tick approval was applied for the entire MOVITRAC[®] B series. C-Tick certifies conformity with ACMA (Australian Communications and Media Authority) standards.

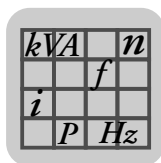

8.2 General technical data

The following technical data applies to all MOVITRAC® B frequency inverters independent of size and power.

MOVITRAC® B	All sizes
Interference immunity	Meets EN 61800-3
Interference emission with EMC-compliant installation	According to limit value class ¹⁾ <ul style="list-style-type: none"> Sizes 0 to 2: C2 without further measures Sizes 0 to 5: C1 with corresponding filters / folding ferrites C1/C2 to EN 61800-3
Leakage current	> 3.5 mA
Ambient temperature ϑ_A (up to 60 °C with current reduction)	<ul style="list-style-type: none"> 230 V, 0.25 – 2.2 kW (0.34 – 3.0 HP) / 400/500 V, 0.25 – 4.0 kW (0.34 – 5.4 HP) With overload capacity (max. 150% for 60 s): $I_D = 100 \% I_N / f_{PWM} = 4 \text{ kHz}: -10 \text{ °C} - +40 \text{ °C} (14 \text{ °F} - 104 \text{ °F})$ Without overload capacity: $I_D = 100 \% I_N / f_{PWM} = 4 \text{ kHz}: -10 \text{ °C} - +50 \text{ °C} (14 \text{ °F} - 122 \text{ °F})$ $I_D = 100 \% I_N / f_{PWM} = 8 \text{ kHz}: -10 \text{ °C} - +40 \text{ °C} (14 \text{ °F} - 104 \text{ °F})$ $I_D = 125 \% I_N / f_{PWM} = 4 \text{ kHz}: -10 \text{ °C} - +40 \text{ °C} (14 \text{ °F} - 104 \text{ °F})$ 3 × 230 V, 3.7 – 30 kW (5.0 – 40 HP) / 400/500 V, 5.5 – 75 kW (7.4 – 100 HP) With overload capacity (max. 150% for 60 s): $I_D = 100 \% I_N / f_{PWM} = 4 \text{ kHz}: 0 \text{ °C} - +40 \text{ °C} (32 \text{ °F} - 104 \text{ °F})$ Without overload capacity: $I_D = 100 \% I_N / f_{PWM} = 4 \text{ kHz}: 0 \text{ °C} - +50 \text{ °C} (32 \text{ °F} - 122 \text{ °F})$ $I_D = 100 \% I_N / f_{PWM} = 8 \text{ kHz}: 0 \text{ °C} - +40 \text{ °C} (32 \text{ °F} - 104 \text{ °F})$ $I_D = 125 \% I_N / f_{PWM} = 4 \text{ kHz}: 0 \text{ °C} - +40 \text{ °C} (32 \text{ °F} - 104 \text{ °F})$ Mounting plate with "cold plate" < 70°C (+158 °F)
Derating ambient temperature (current reduction)	2.5 % I_N per K at 40 °C – 50 °C (104 °F – 122 °F) 3 % I_N per K at 50 °C – 60 °C (122 °F – 140 °F)
Climate class	EN 60721-3-3, class 3K3
Storage temperature Transport temperature	-25 °C – +75 °C (-13 °F – 167 °F) -25 °C – +75 °C (-13 °F – 167 °F)
Type of cooling	Self-cooled: 230 V: ≤ 0.75 kW (1.0 HP) 400/500 V: ≤ 1.1 kW (1.5 HP) Forced cooling: 230 V: ≥ 1.1 kW (1.5 HP) (temperature controlled fan, 400/500 V: ≥ 1.5 kW (3.0 HP) Response threshold 45 °C (113 °F))
Degree of protection EN 60529 (NEMA1)	Sizes 0 to 3: IP20 Sizes 4 – 5 power connections: <ul style="list-style-type: none"> IP00 With the supplied Plexiglas cover mounted and shrinking tube mounted (not supplied) IP10
Duty cycle	Continuous duty
Overvoltage category	III according to IEC 60664-1 (VDE 0110-1)
Mains voltage tolerance	EN 50160: ±10 %
Pollution class	2 according to IEC 60664-1 (VDE 0110-1)

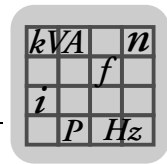

MOVITRAC® B	All sizes
Installation altitude	<p>Up to $h \leq 1000$ m (3281 ft) without restrictions. The following restrictions apply at $h \geq 1000$ m (3281 ft):</p> <ul style="list-style-type: none"> from 1000 m (3281 ft) to max. 4000 m (13120 ft): <ul style="list-style-type: none"> I_N reduction by 1 % per 100 m (328 ft) from 2000 m (6562 ft) to max. 4000 m (13120 ft): <ul style="list-style-type: none"> AC 230 V units: Reduction of the rated mains voltage V_{mains} by AC 3 V per 100 m (328 ft) AC 500 V units: Reduction of the rated mains voltage V_{mains} by AC 6 V per 100 m (328 ft) <p>Over 2000 m (6562 ft) only overvoltage class 2, external measures are required for overvoltage class 3. Overvoltage classes according to DIN VDE 0110-1.</p>
Dimensioning	According to DIN ISO 276-v
Size 0: Restrictions for continuous duty with 125 % I_N	<ul style="list-style-type: none"> Maximum ambient temperature ϑ_A: 40 °C (104 °F) Maximum rated mains voltage V_{mains}: 400 V No DIN rail mounting / submounting resistor At 1 × 230 V: Provide ND line choke

1) Electrical installation in compliance with applicable regulations is necessary for maintaining the EMC limit value class. Comply with the installation notes.

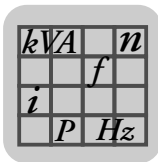
8.3 MOVITRAC® B electronics data

Function	Terminal	Designation	Default	Data
Setpoint input ¹⁾ (differential input)	X10:1 X10:2 X10:3 X10:4	REF1 AI11 (+) AI12 (-) GND		+10 V, $R_{Lmin} = 3 \text{ k}\Omega$ 0 – +10 V ($R_i > 200 \text{ k}\Omega$) 0 – 20 mA / 4 – 20 mA ($R_i = 250 \Omega$), 10 bit resolution, sampling time 1 ms GND = Reference potential for binary and analog signals, PE potential
Binary inputs	X12:1 X12:2 X12:3 X12:4 X12:5 X12:6	DI00 DI01 DI02 DI03 DI04 DI05TF	Fault reset CW/halt CCW/halt Enable/stop n11/n21 n12/n22	$R_i = 3 \text{ k}\Omega$, $I_E = 10 \text{ mA}$, sampling time 5 ms, PLC compatible Signal level according to EN 61131-2 type 1 or 3: <ul style="list-style-type: none"> +11 – +30 V → 1 / contact closed -3 – +5 V → 0 / contact open X12:2 / DI01 with fixed assignment CW/halt X12:5 / DI04 can be used as frequency input X12:6 / DI05 can be used as TF input
Supply voltage for TF	X12:7	VOTF		Special characteristics for TF according to DIN EN 60947-8 / trigger value 3 kΩ
Auxiliary voltage output/external voltage supply ²⁾	X12:8	24VIO		Auxiliary supply output: $V = \text{DC } 24 \text{ V}$, current carrying capacity $I_{max} = 50 \text{ mA}$ External voltage supply: $V = \text{DC } 24 \text{ V} -15\% / +20\%$ according to EN 61131-2 See the Project planning/external DC 24 V voltage supply section.
Reference terminal	X12:9	GND		Reference potential for binary and analog signals, PE potential
Binary outputs	X13:1 X13:2 X13:3 X13:4	GND DO02 DO03 GND	Brake released Ready	PLC compatible, response time 5 ms, $I_{max} \text{ DO02} = 150 \text{ mA}$, $I_{max} \text{ DO03} = 50 \text{ mA}$, short-circuit proof, protected against external voltage up to 30 V GND = Reference potential for binary and analog signals, PE potential
Relay output	X13:5 X13:6 X13:7	DO01-C DO01-NO DO01-NC		Shared relay contact NO contact NC contact Load capacity: $V_{max} = 30 \text{ V}$, $I_{max} = 800 \text{ mA}$

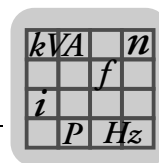

Function	Terminal	Designation	Default	Data	
Safety contact	X17:1	GND: Reference potential for X17:2			
	X17:2	VO24: $U_{OUT} = DC\ 24\ V$, only to supply X17:4 of the same unit; it cannot be used to supply other units.			
	X17:3	SOV24: Reference potential for DC+24 V "safe stop" input (safety contact)			
	X17:4	SVI24: DC+24 V "safe stop" input (safety contact)			
	Permitted cable cross section		One core per terminal: 0.08 – 1.5 mm ² (AWG28 – 16) Two cores per terminal: 0.25 – 1.0 mm ² (AWG23 – 17)		
	Power consumption X17:4		Size 0: 3 W Size 1: 5 W Size 2, 2S: 6 W Size 3: 7.5 W Size 4: 8 W Size 5: 10 W		
Input capacitance X17:4		Size 0: 27 µF Sizes 1 to 5: 270 µF			
Time for restart Time to inhibit output stage		$t_A = 200\ ms$ $t_S = 200\ ms$			
Signal level		DC +19.2 V – +30 V = "1" = contact closed DC –30 V – +5 V = "0" = contact open			
Terminal response times	Binary input and output terminals are updated every 5 ms				
Max. cable cross-section	1.5 mm ² (AWG15) without conductor end sleeves 1.0 mm ² (AWG17) with conductor end sleeves				
Cable stripping length	X10 / X12 / X13: 5 mm FSC11B / FIO11B / FIO21B: 7 mm				
Tightening torque	X10 / X12 / X13: 0.25 Nm FSC11B / FIO11B / FIO21B: 0.22 – 0.25 Nm				

- 1) If the setpoint input is not used, it should be set to GND. Otherwise a measured input voltage of –1 V ... +1 V is set.
- 2) The MC07B...-S0 unit type must always be supplied with external voltage.

8.3.1 DC 24 V power demand for 24 V backup mode

Size	Basic unit power demand ¹⁾	DBG60B	FIO11B	Fieldbus option ²⁾³⁾	DHP11B ³⁾
0 MC07B...-00	5 W	1 W	2 W	3 W	4.5 W
0 MC07B...-S0	12 W				
1, 2S, 2	17 W				
3	23 W				
4, 5	25 W				

- 1) FBG11B, FSC11B (UWS11A/USB11A) included. Take account of the additional load of the binary inputs with 2.4 W per 100 mA.
- 2) Fieldbus options are: DFP21B, DFD11B, DFE11B, ...
- 3) These options must always be supplied externally.

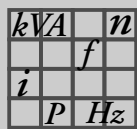

8.4 Technical data of MOVITRAC® B

8.4.1 Overview of MOVITRAC® B

400 / 500 V

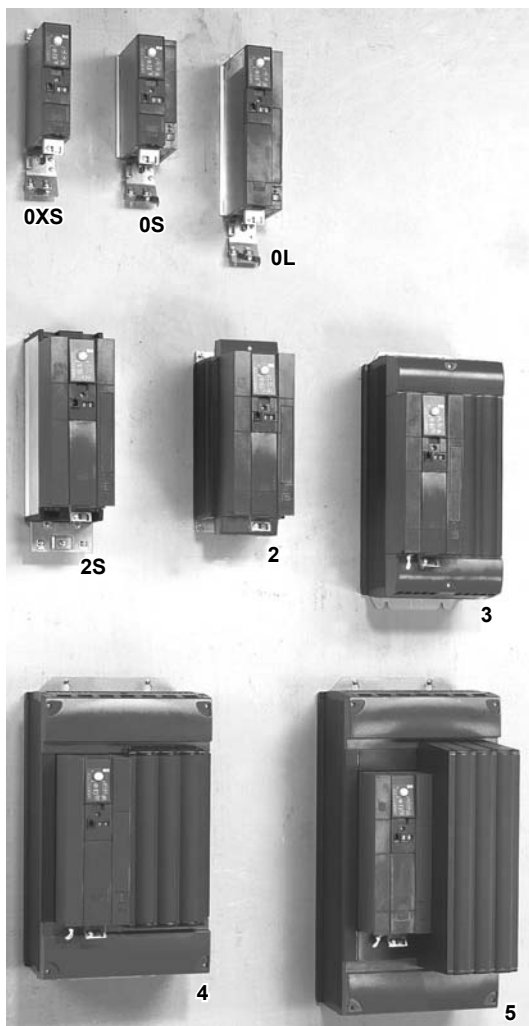

230 V

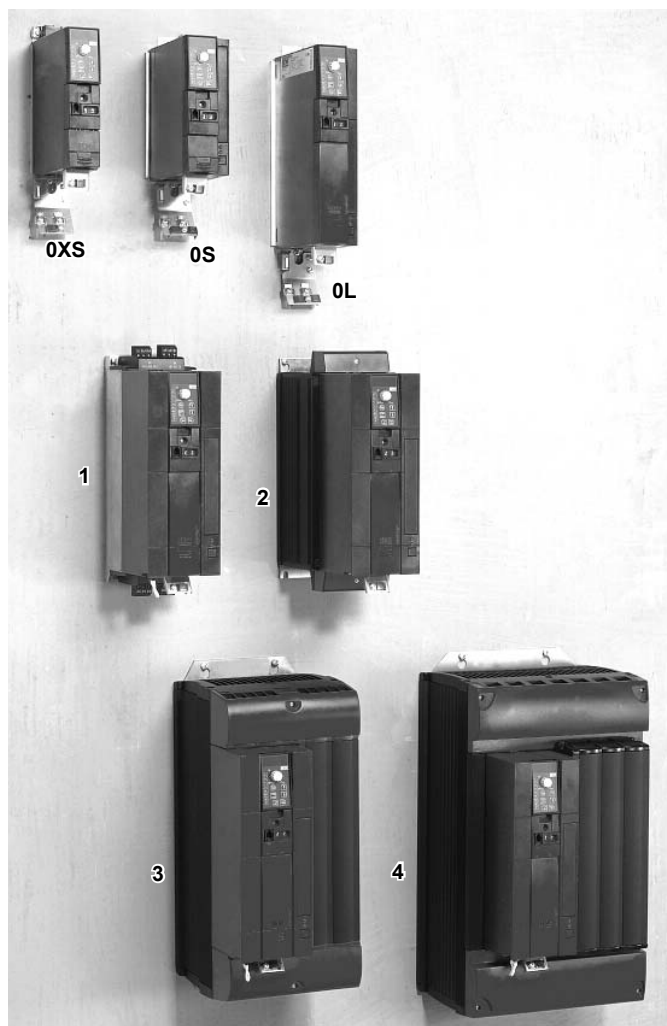

Power supply connection 400 / 500 V / 3-phase

Size	0XS	0S	0L	2S	2	3	4	5
Power [kW / HP]	0.25 / 0.34 0.37 / 0.50	0.55 / 0.74 0.75 / 1.0 1.1 / 1.5 1.5 / 2.0	2.2 / 3.0 3.0 / 4.0 4.0 / 5.4	5.5 / 7.4 7.5 / 10	11 / 15	15 / 20 22 / 30 30 / 40	37 / 50 45 / 60	55 / 74 75 / 100

Power supply connection 230 V / 1-phase

Size	0XS	0S	0L
Power [kW / HP]	0.25 / 0.34 0.37 / 0.50	0.55 / 0.74 0.75 / 1.0	1.1 / 1.5 1.5 / 2.0 2.2 / 3.0

Power supply connection 230 V / 3-phase

Size	0XS	0S	0L	1	2	3	4
Power [kW / HP]	0.25 / 0.34 0.37 / 0.50	0.55 / 0.74 0.75 / 1.0	1.1 / 1.5 1.5 / 2.0 2.2 / 3.0	3.7 / 5.0	5.5 / 7.4 7.5 / 10	11 / 15 15 / 20	22 / 30 30 / 40

8.4.2 AC 400 / 500 V / 3-phase / size 0XS / 0.25 / 0.37 kW / 0.34 / 0.50 HP

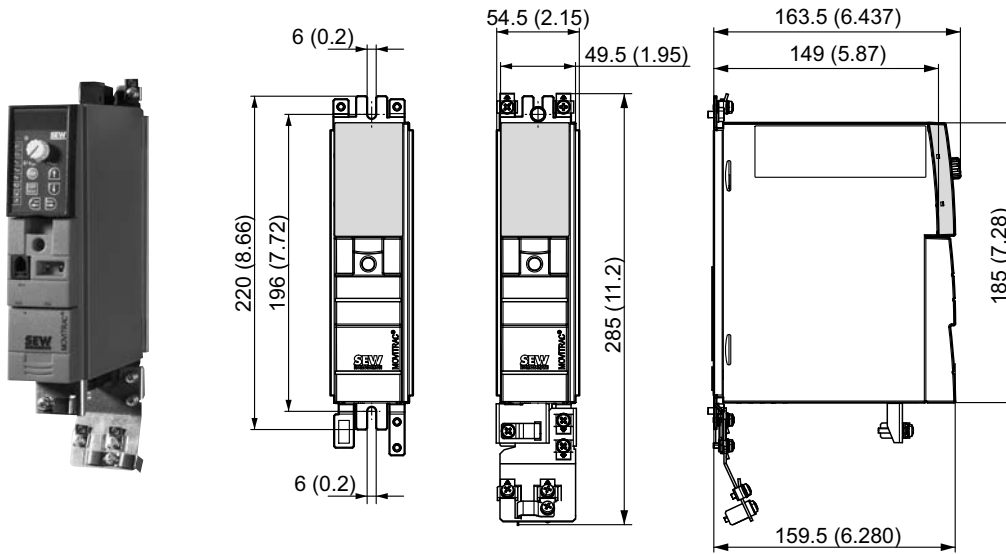

MOVITRAC® MC07B (3-phase power supply)		0003-5A3-4-00	0004-5A3-4-00
Part number		828 515 2	828 516 0
INPUT¹⁾			
Rated mains voltage	V_{mains}	3 × AC 380 – 500 V	
Rated mains frequency	f_{mains}	50 / 60 Hz ± 5 %	
Rated mains current, 100 % operation	I_{mains}	AC 0.9 A	AC 1.4 A
Rated mains current, 125 % operation	$I_{\text{mains 125}}$	AC 1.1 A	AC 1.8 A
OUTPUT			
Output voltage	V_O	3 × 0 – U_{mains}	
Recommended motor power 100 % operation	P_{Mot}	0.25 kW / 0.34 HP	0.37 kW / 0.50 HP
Recommended motor power 125 % operation	$P_{\text{Mot 125}}$	0.37 kW / 0.50 HP	0.55 kW / 0.74 HP
Rated output current 100 % operation	I_N	AC 1.0 A	AC 1.6 A
Rated output current 125 % operation	$I_{N 125}$	AC 1.3 A	AC 2.0 A
Apparent output power 100 % operation	S_N	0.7 kVA	1.1 kVA
Apparent output power 125 % operation	$S_{N 125}$	0.9 kVA	1.4 kVA
Minimum permitted braking resistance value (4 quadrant operation)	$R_{\text{BW_min}}$	68 Ω	
GENERAL INFORMATION			
Power loss 100 % operation	P_V	30 W	35 W
Power loss 125 % operation	$P_{V 125}$	35 W	40 W
Current limitation		150 % I_N for at least 60 seconds	
Terminal cross section / tightening torque	Terminals	4 mm ² / AWG12 / 0.5 Nm / 4 lb in	
Dimensions	W × H × D	54.5 × 185 × 163.5 mm / 2.15 × 7.28 × 6.437 in	
Mass	m	1.3 kg / 2.9 lb	

1) The mains and output currents must be reduced by 20 % from the nominal values for $V_{\text{mains}} = 3 \times \text{AC } 500 \text{ V}$.

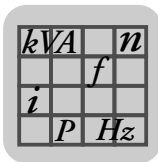

8.4.3 AC 400 / 500 V / 3-phase / size 0S / 0.55 / 0.75 / 1.1 / 1.5 kW / 0.74 / 1.0 / 1.5 / 2.0 HP

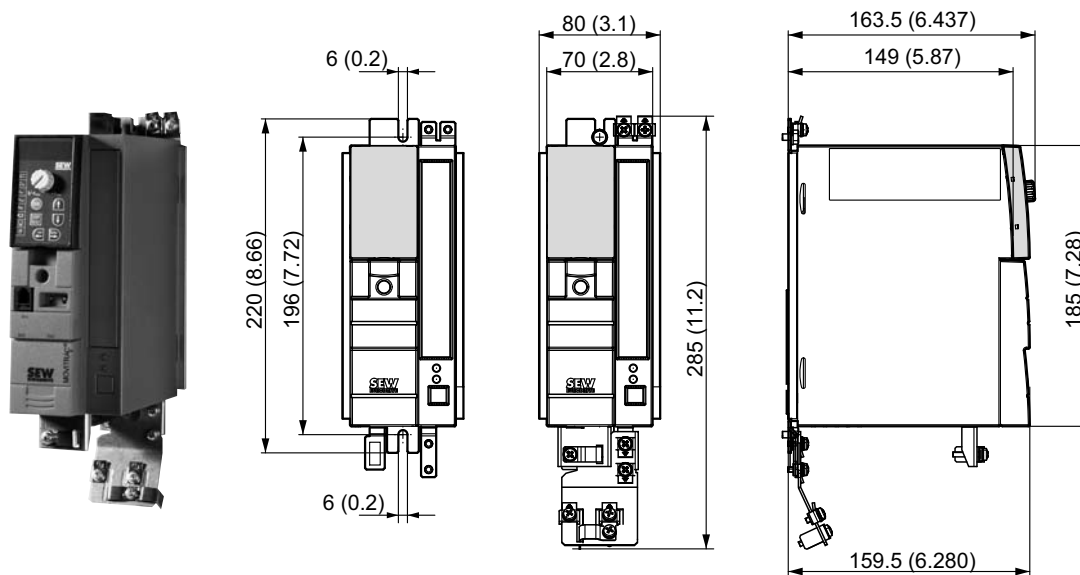

MOVITRAC® MC07B (3-phase power supply)		0005-5A3-4-x0	0008-5A3-4-x0	0011-5A3-4-x0	0015-5A3-4-x0
Part number, standard unit (-00)		828 517 9	828 518 7	828 519 5	828 520 9
Part number "Safe stop" (-S0) ¹⁾		828 995 6	828 996 4	828 997 2	828 998 0
INPUT²⁾					
Rated mains voltage	V_{mains}	3 × AC 380 – 500 V			
Rated mains frequency	f_{mains}	50 / 60 Hz ± 5 %			
Rated mains current, 100 % operation	I_{mains}	AC 1.8 A	AC 2.2 A	AC 2.8 A	AC 3.6 A
Rated mains current, 125 % operation	$I_{\text{mains 125}}$	AC 2.3 A	AC 2.6 A	AC 3.5 A	AC 4.5 A
OUTPUT					
Output voltage	V_O	3 × 0 – V_{mains}			
Recommended motor power 100 % operation	P_{Mot}	0.55 kW / 0.74 HP	0.75 kW / 1.0 HP	1.1 kW / 1.5 HP	1.5 kW / 2.0 HP
	$P_{\text{Mot 125}}$	0.75 kW / 1.0 HP	1.1 kW / 1.5 HP	1.5 kW / 2.0 HP	2.2 kW / 3.0 HP
Rated output current 100 % operation	I_N	AC 2.0 A	AC 2.4 A	AC 3.1 A	AC 4.0 A
Rated output current 125 % operation	$I_{N 125}$	AC 2.5 A	AC 3.0 A	AC 3.9 A	AC 5.0 A
Apparent output power 100 % operation	S_N	1.4 kVA	1.7 kVA	2.1 kVA	2.8 kVA
Apparent output power 125 % operation	$S_{N 125}$	1.7 kVA	2.1 kVA	2.7 kVA	3.5 kVA
Minimum permitted braking resistance value (4 quadrant operation)	$R_{\text{BW_min}}$	68 Ω			
GENERAL INFORMATION					
Power loss 100 % operation	P_V	40 W	45 W	50 W	60 W
Power loss 125 % operation	$P_{V 125}$	45 W	50 W	60 W	75 W
Current limitation		150 % I_N for at least 60 seconds			
Terminal cross section / tightening torque	Terminals	4 mm ² / AWG12 / 0.5 Nm / 4 lb in			
Dimensions	W × H × D	80 × 185 × 163.5 mm / 3.1 × 7.28 × 6.437 in			
Mass	m	1.5 kg / 3.3 lb			

1) The unit type MC07B...-S0 must always be supplied by an external DC 24 V power supply unit.

2) The mains and output currents must be reduced by 20 % from the nominal values for $V_{\text{mains}} = 3 \times \text{AC } 500 \text{ V}$.

8.4.4 AC 400 / 500 V / 3-phase / size 0L / 2.2 / 3.0 / 4.0 kW / 3.0 / 4.0 / 5.4 HP

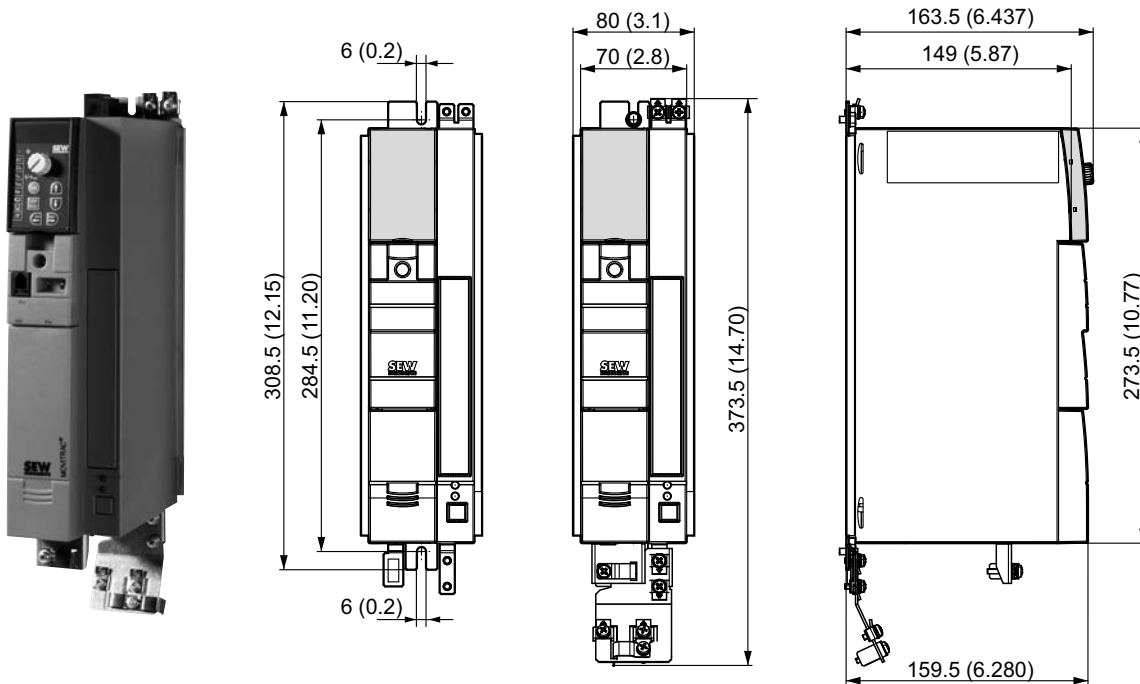

MOVITRAC® MC07B (3-phase power supply)	0022-5A3-4-x0	0030-5A3-4-x0	0040-5A3-4-x0
Part number, standard unit (-00)	828 521 7	828 522 5	828 523 3
Part number "Safe stop" (-S0) ¹⁾	828 999 9	829 000 8	829 001 6
INPUT²⁾			
Rated mains voltage	V _{mains}	3 × AC 380 – 500 V	
Rated mains frequency	f _{mains}	50 / 60 Hz ± 5 %	
Rated mains current, 100 % operation	I _{mains}	AC 5.0 A	AC 6.3 A
Rated mains current, 125 % operation	I _{mains 125}	AC 6.2 A	AC 7.9 A
OUTPUT			
Output voltage	V _O	3 × 0 – V _{mains}	
Recommended motor power 100 % operation	P _{Mot}	2.2 kW / 3.0 HP	3.0 kW / 4.0 HP
Recommended motor power 125 % operation	P _{Mot 125}	3.0 kW / 4.0 HP	4.0 kW / 5.4 HP
Rated output current 100 % operation	I _N	AC 5.5 A	AC 7.0 A
Rated output current 125 % operation	I _{N 125}	AC 6.9 A	AC 8.8 A
Apparent output power 100 % operation	S _N	3.8 kVA	4.8 kVA
Apparent output power 125 % operation	S _{N 125}	4.8 kVA	6.1 kVA
Minimum permitted braking resistance value (4 quadrant operation)	R _{BW_min}	68 Ω	
GENERAL INFORMATION			
Power loss 100 % operation	P _V	80 W	95 W
Power loss 125 % operation	P _{V 125}	95 W	120 W
Current limitation		150 % I _N for at least 60 seconds	
Terminal cross section / tightening torque	Terminals	4 mm ² / AWG12 / 0.5 Nm / 4 lb in	
Dimensions	W × H × D	80 × 273.5 × 163.5 mm / 3.1 × 10.77 × 6.437 in	
Mass	m	2.1 kg / 4.6 lb	

1) The unit type MC07B...-S0 must always be supplied by an external DC 24 V power supply unit.

2) The mains and output currents must be reduced by 20 % from the nominal values for V_{mains} = 3 × AC 500 V.

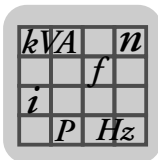

8.4.5 AC 400 / 500 V / 3-phase / size 2S / 5.5 / 7.5 kW / 7.4 / 10 HP

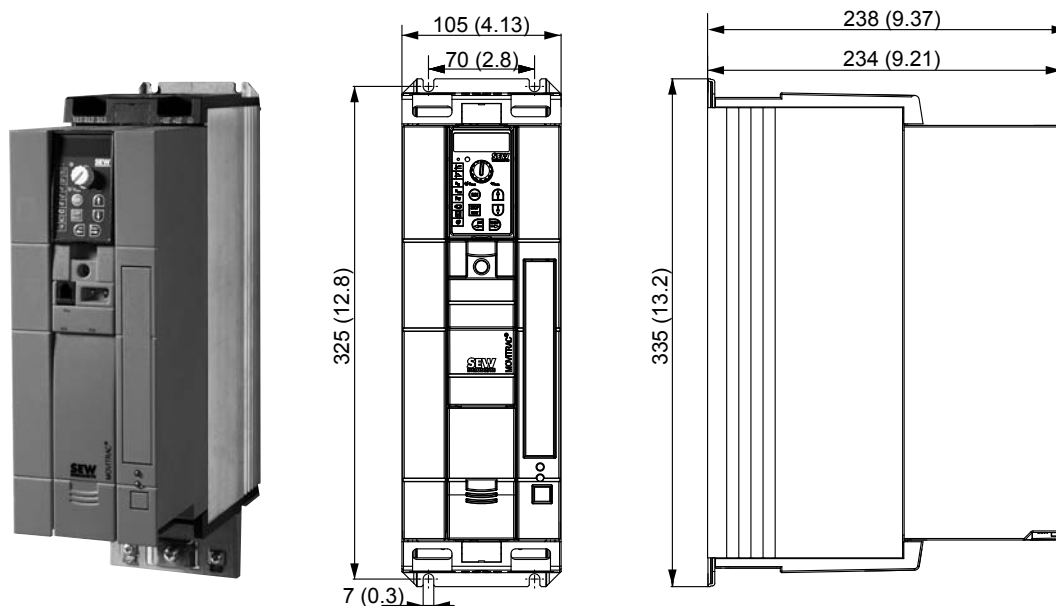

MOVITRAC® MC07B (3-phase power supply)		0055-5A3-4-00	0075-5A3-4-00
Part number		828 524 1	828 526 8
INPUT¹⁾			
Rated mains voltage	V_{mains}	3 × AC 380 – 500 V	
Rated mains frequency	f_{mains}	50 / 60 Hz ± 5 %	
Rated mains current, 100 % operation	I_{mains}	AC 11.3 A	AC 14.4 A
Rated mains current, 125 % operation	$I_{\text{mains 125}}$	AC 14.1 A	AC 18.0 A
OUTPUT			
Output voltage	V_{O}	3 × 0 – U_{mains}	
Recommended motor power 100 % operation	P_{Mot}	5.5 kW / 7.4 HP	7.5 kW / 10 HP
Recommended motor power 125 % operation	$P_{\text{Mot 125}}$	7.5 kW / 10 HP	11 kW / 15 HP
Rated output current 100 % operation	I_{N}	AC 12.5 A	AC 16 A
Rated output current 125 % operation	$I_{\text{N 125}}$	AC 15.6 A	AC 20 A
Apparent output power 100 % operation	S_{N}	8.7 kVA	11.1 kVA
Apparent output power 125 % operation	$S_{\text{N 125}}$	10.8 kVA	13.9 kVA
Minimum permitted braking resistance value (4 quadrant operation)	$R_{\text{BW_min}}$	47 Ω	
GENERAL INFORMATION			
Power loss 100 % operation	P_{V}	220 W	290 W
Power loss 125 % operation	$P_{\text{V 125}}$	290 W	370 W
Current limitation		150 % I_{N} for at least 60 seconds	
Terminal cross section / tightening torque	Terminals	4 mm ² / AWG12 / 0.6 Nm / 5 lb in	
Dimensions	W × H × D	105 × 335 × 238 mm / 4.13 × 13.2 × 9.37 in	
Mass	m	5.0 kg / 11 lb	

1) The mains and output currents must be reduced by 20 % from the nominal values for $V_{\text{mains}} = 3 \times \text{AC } 500 \text{ V}$.

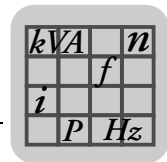

8.4.6 AC 400 / 500 V / 3-phase / size 2 / 11 kW / 15 HP

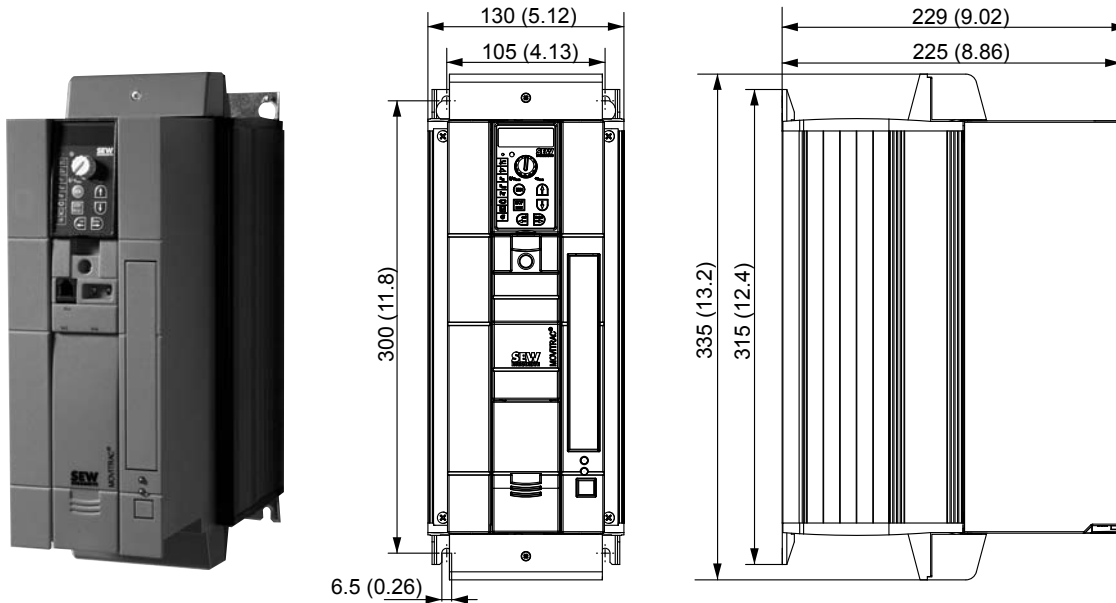

MOVITRAC® MC07B (3-phase power supply)		0110-5A3-4-00
Part number		828 527 6
INPUT¹⁾		
Rated mains voltage	V_{mains}	3 × AC 380 – 500 V
Rated mains frequency	f_{mains}	50 / 60 Hz ± 5 %
Rated mains current, 100 % operation	I_{mains}	AC 21.6 A
Rated mains current, 125 % operation	$I_{\text{mains 125}}$	AC 27.0 A
OUTPUT		
Output voltage	V_{O}	3 × 0 – V_{mains}
Recommended motor power 100 % operation	P_{Mot}	11 kW / 15 HP
Recommended motor power 125 % operation	$P_{\text{Mot 125}}$	15 kW / 20 HP
Rated output current 100 % operation	I_{N}	AC 24 A
Rated output current 125 % operation	$I_{\text{N 125}}$	AC 30 A
Apparent output power 100 % operation	S_{N}	16.6 kVA
Apparent output power 125 % operation	$S_{\text{N 125}}$	20.8 kVA
Minimum permitted braking resistance value (4 quadrant operation)	$R_{\text{BW_min}}$	22 Ω
GENERAL INFORMATION		
Power loss 100 % operation	P_{V}	400 W
Power loss 125 % operation	$P_{\text{V 125}}$	500 W
Current limitation		150 % I_{N} for at least 60 seconds
Terminal cross section / tightening torque	Terminals	4 mm ² / AWG12 / 1.5 Nm / 13 lb in
Dimensions	W × H × D	130 × 335 × 229 mm / 5.12 × 13.2 × 9.02 in
Mass	m	6.6 kg / 15 lb

1) The mains and output currents must be reduced by 20 % from the nominal values for $V_{\text{mains}} = 3 \times \text{AC } 500 \text{ V}$.

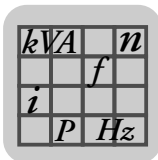

8.4.7 AC 400 / 500 V / 3-phase / size 3 / 15 / 22 / 30 kW / 20 / 30 / 40 HP

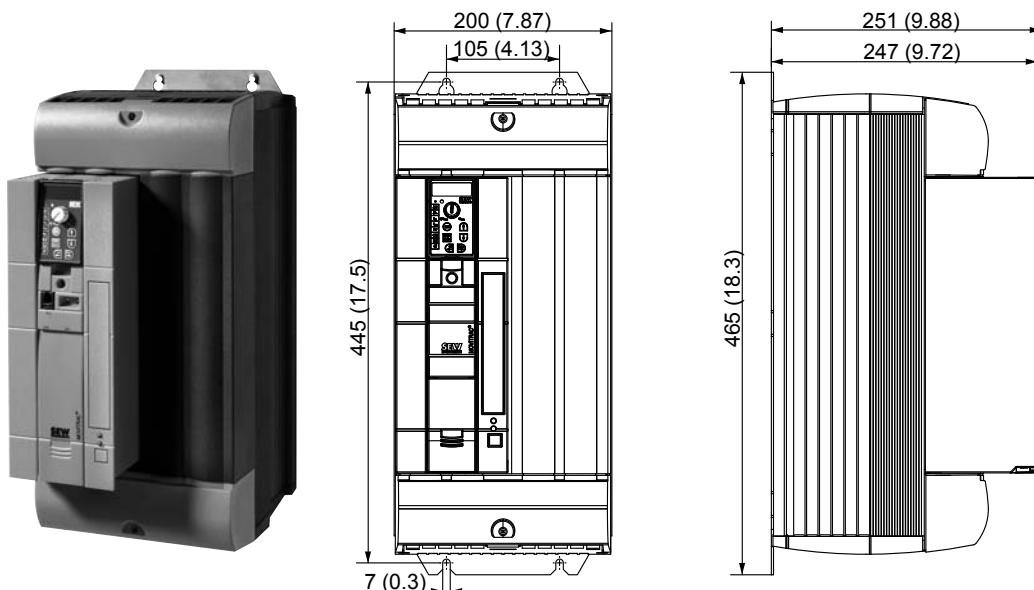

MOVITRAC® MC07B (3-phase power supply)		0150-503-4-00	0220-503-4-00	0300-503-4-00
Part number		828 528 4	828 529 2	828 530 6
INPUT¹⁾				
Rated mains voltage	V_{mains}	3 × AC 380 – 500 V		
Rated mains frequency	f_{mains}	50 / 60 Hz ± 5 %		
Rated mains current, 100 % operation	I_{mains}	AC 28.8 A	AC 41.4 A	AC 54.0 A
Rated mains current, 125 % operation	$I_{\text{mains 125}}$	AC 36.0 A	AC 51.7 A	AC 67.5 A
OUTPUT				
Output voltage	V_{O}	3 × 0 – V_{mains}		
Recommended motor power 100 % operation	P_{Mot}	15 kW / 20 HP	22 kW / 30 HP	30 kW / 40 HP
Recommended motor power 125 % operation	$P_{\text{Mot 125}}$	22 kW / 30 HP	30 kW / 40 HP	37 kW / 50 HP
Rated output current 100 % operation	I_{N}	AC 32 A	AC 46 A	AC 60 A
Rated output current 125 % operation	$I_{\text{N 125}}$	AC 40 A	AC 57.5 A	AC 75 A
Apparent output power 100 % operation	S_{N}	22.2 kVA	31.9 kVA	41.6 kVA
Apparent output power 125 % operation	$S_{\text{N 125}}$	27.7 kVA	39.8 kVA	52.0 kVA
Minimum permitted braking resistance value (4 quadrant operation)	$R_{\text{BW_min}}$	15 Ω	12 Ω	
GENERAL INFORMATION				
Power loss 100 % operation	P_{V}	550 W	750 W	950 W
Power loss 125 % operation	$P_{\text{V 125}}$	690 W	940 W	1250 W
Current limitation		150 % I_{N} for at least 60 seconds		
Terminal cross section / tightening torque	Terminals	6 mm ² / AWG10	10 mm ² / AWG8	16 mm ² / AWG6
		3.5 Nm / 31 lb in		
Dimensions	W × H × D	200 × 465 × 251 mm / 7.87 × 18.3 × 9.88 in		
Mass	m	15 kg / 33 lb		

1) The mains and output currents must be reduced by 20 % from the nominal values for $V_{\text{mains}} = 3 \times \text{AC } 500 \text{ V}$.

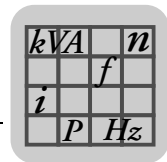

8.4.8 AC 400 / 500 V / 3-phase / size 4 / 37 / 45 kW / 50 / 60 HP

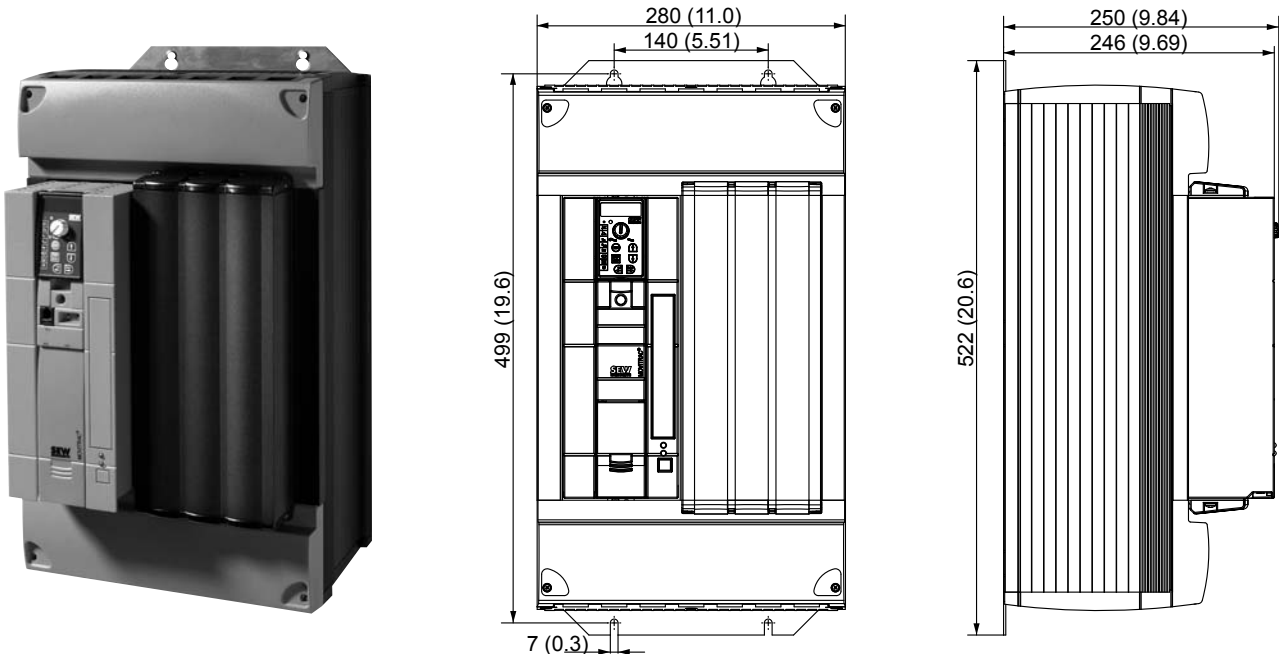

MOVITRAC® MC07B (3-phase power supply)		0370-503-4-00	0450-503-4-00
Part number		828 531 4	828 532 2
INPUT¹⁾			
Rated mains voltage	V_{mains}	3 × AC 380 – 500 V	
Rated mains frequency	f_{mains}	50 / 60 Hz ± 5 %	
Rated mains current, 100 % operation	I_{mains}	AC 65.7 A	AC 80.1 A
Rated mains current, 125 % operation	$I_{\text{mains 125}}$	AC 81.9 A	AC 100.1 A
OUTPUT			
Output voltage	V_{O}	3 × 0 – V_{mains}	
Recommended motor power 100 % operation	P_{Mot}	37 kW / 50 HP	45 kW / 60 HP
Recommended motor power 125 % operation	$P_{\text{Mot 125}}$	45 kW / 60 HP	55 kW / 74 HP
Rated output current 100 % operation	I_{N}	AC 73 A	AC 89 A
Rated output current 125 % operation	$I_{\text{N 125}}$	AC 91.3 A	AC 111.3 A
Apparent output power 100 % operation	S_{N}	50.6 kVA	61.7 kVA
Apparent output power 125 % operation	$S_{\text{N 125}}$	63.2 kVA	77.1 kVA
Minimum permitted braking resistance value (4 quadrant operation)	$R_{\text{BW_min}}$	6 Ω	
GENERAL INFORMATION			
Power loss 100 % operation	P_{V}	1200 W	1400 W
Power loss 125 % operation	$P_{\text{V 125}}$	1450 W	1820 W
Current limitation		150 % I_{N} for at least 60 seconds	
Terminal cross section / tightening torque	Terminals	25 mm ² / AWG4	35 mm ² / AWG2
		14 Nm / 120 lb in	
Dimensions	$W \times H \times D$	280 × 522 × 250 mm / 11.0 × 20.6 × 9.84 in	
Mass	m	27 kg / 60 lb	

1) The mains and output currents must be reduced by 20 % from the nominal values for $V_{\text{mains}} = 3 \times \text{AC } 500 \text{ V}$.

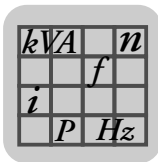

8.4.9 AC 400 / 500 V / 3-phase / size 5 / 55 / 75 kW / 74 / 100 HP

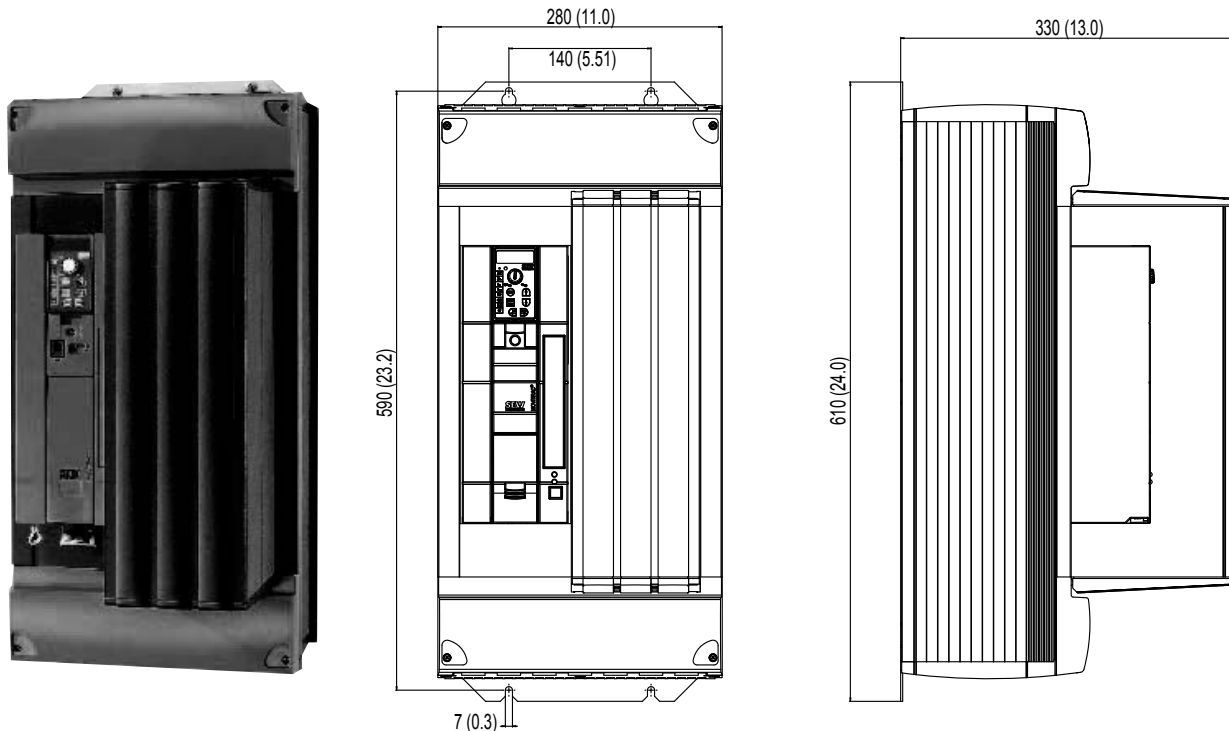

MOVITRAC® MC07B (3-phase power supply)		0550-503-4-00	0750-503-4-00
Part number		829 527 1	829 529 8
INPUT¹⁾			
Rated mains voltage	V_{mains}	3 × AC 380 – 500 V	
Rated mains frequency	f_{mains}	50 / 60 Hz ± 5 %	
Rated mains current, 100 % operation	I_{mains}	AC 94.5 A	AC 117 A
Rated mains current, 125 % operation	$I_{\text{mains 125}}$	AC 118.1 A	AC 146.3 A
OUTPUT			
Output voltage	V_{O}	3 × 0 – V_{mains}	
Recommended motor power 100 % operation	P_{Mot}	55 kW / 74 HP	75 kW / 100 HP
Recommended motor power 125 % operation	$P_{\text{Mot 125}}$	75 kW / 100 HP	90 kW / 120 HP
Rated output current 100 % operation	I_{N}	AC 105 A	AC 130 A
Rated output current 125 % operation	$I_{\text{N 125}}$	AC 131 A	AC 162 A
Apparent output power 100 % operation	S_{N}	73.5 kVA	91.0 kVA
Apparent output power 125 % operation	$S_{\text{N 125}}$	90.8 kVA	112.2 kVA
Minimum permitted braking resistance value (4 quadrant operation)	$R_{\text{BW_min}}$	6 Ω	4 Ω
GENERAL INFORMATION			
Power loss 100 % operation	P_{V}	1700 W	2000 W
Power loss 125 % operation	$P_{\text{V 125}}$	2020 W	2300 W
Current limitation		150 % I_{N} for at least 60 seconds	
Terminal cross section / tightening torque	Terminals	35 mm ² / AWG2	50 mm ² / AWG0
		14 Nm / 120 lb in	
Dimensions	W × H × D	280 × 610 × 330 mm / 11.0 × 24.0 × 13.0 in	
Mass	m	35 kg / 77 lb	

1) The mains and output currents must be reduced by 20 % from the nominal values for $V_{\text{mains}} = 3 \times \text{AC } 500 \text{ V}$.

8.4.10 AC 230 V / 1-phase / size 0XS / 0.25 / 0.37 kW / 0.34 / 0.50 HP

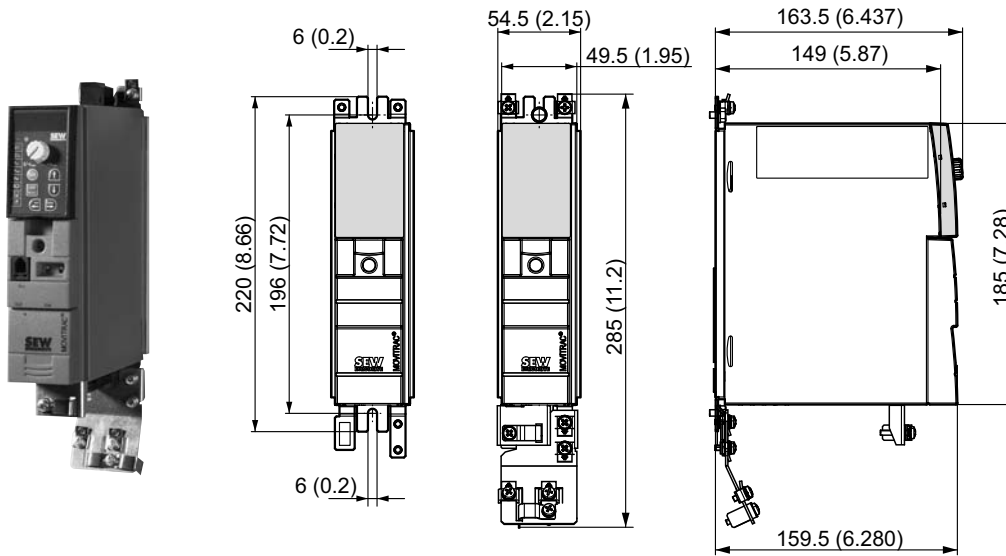

MOVITRAC® MC07B (1-phase power supply)		0003-2B1-4-00	0004-2B1-4-00
Part number		828 491 1	828 493 8
INPUT			
Rated mains voltage	V_{mains}	1 × AC 200 – 240 V	
Rated mains frequency	f_{mains}	50 / 60 Hz ± 5 %	
Rated mains current, 100 % operation	I_{mains}	AC 4.3 A	AC 6.1 A
Rated mains current, 125 % operation	$I_{mains\ 125}$	AC 5.5 A	AC 7.5 A
OUTPUT			
Output voltage	V_O	3 × 0 – V_{mains}	
Recommended motor power 100 % operation	P_{Mot}	0.25 kW / 0.34 HP	0.37 kW / 0.50 HP
Recommended motor power 125 % operation	$P_{Mot\ 125}$	0.37 kW / 0.50 HP	0.55 kW / 0.74 HP
Rated output current 100 % operation	I_N	AC 1.7 A	AC 2.5 A
Rated output current 125 % operation	$I_{N\ 125}$	AC 2.1 A	AC 3.1 A
Apparent output power 100 % operation	S_N	0.7 kVA	1.0 kVA
Apparent output power 125 % operation	$S_{N\ 125}$	0.9 kVA	1.3 kVA
Minimum permitted braking resistance value (4 quadrant operation)	R_{BW_min}	27 Ω	
GENERAL INFORMATION			
Power loss 100 % operation	P_V	30 W	35 W
Power loss 125 % operation	$P_{V\ 125}$	35 W	45 W
Current limitation		150 % I_N for at least 60 seconds	
Terminal cross section / tightening torque	Terminals	4 mm ² / AWG12 / 0.5 Nm / 4 lb in	
Dimensions	W × H × D	54.5 × 185 × 163.5 mm / 2.15 × 7.28 × 6.437 in	
Mass	m	1.3 kg / 2.9 lb	

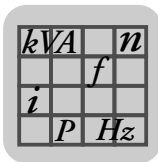

Technical Data

Technical data of MOVITRAC® B

8.4.11 AC 230 V / 1-phase / size 0S / 0.55 / 0.75 kW / 0.74 / 1.0 HP

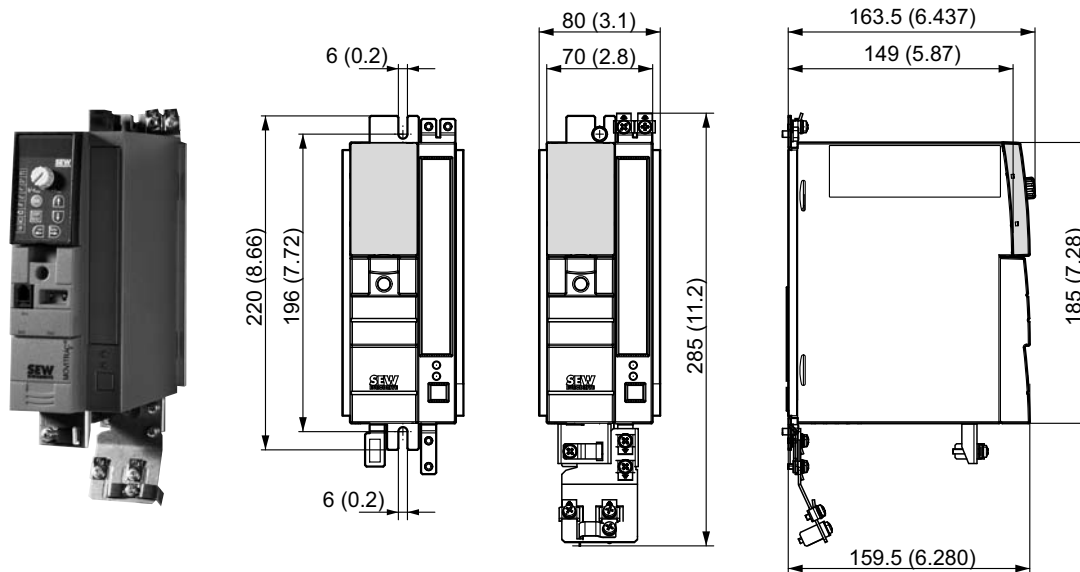

MOVITRAC® MC07B (1-phase power supply)		0005-2B1-4-00	0008-2B1-4-00
Part number		828 494 6	828 495 4
INPUT			
Rated mains voltage	V_{mains}	1 × AC 200 – 240 V	
Rated mains frequency	f_{mains}	50 / 60 Hz ± 5 %	
Rated mains current, 100 % operation	I_{mains}	AC 8.5 A	AC 9.9 A
Rated mains current, 125 % operation	$I_{\text{mains 125}}$	AC 10.2 A	AC 11.8 A
OUTPUT			
Output voltage	V_O	3 × 0 – V_{mains}	
Recommended motor power 100 % operation	P_{Mot}	0.55 kW / 0.74 HP	0.75 kW / 1.0 HP
Recommended motor power 125 % operation	$P_{\text{Mot 125}}$	0.75 kW / 1.0 HP	1.1 kW / 1.5 HP
Rated output current 100 % operation	I_N	AC 3.3 A	AC 4.2 A
Rated output current 125 % operation	$I_{N 125}$	AC 4.1 A	AC 5.3 A
Apparent output power 100 % operation	S_N	1.4 kVA	1.7 kVA
Apparent output power 125 % operation	$S_{N 125}$	1.7 kVA	2.1 kVA
Minimum permitted braking resistance value (4 quadrant operation)	$R_{\text{BW_min}}$	27 Ω	
GENERAL INFORMATION			
Power loss 100 % operation	P_V	45 W	50 W
Power loss 125 % operation	$P_{V 125}$	50 W	65 W
Current limitation		150 % I_N for at least 60 seconds	
Terminal cross section / tightening torque	Terminals	4 mm ² / AWG12 / 0.5 Nm / 4 lb in	
Dimensions	W × H × D	80 × 185 × 163.5 mm / 3.1 × 7.28 × 6.437 in	
Mass	m	1.5 kg / 3.3 lb	

8.4.12 AC 230 V / 1-phase / size 0L / 1.1 / 1.5 / 2.2 kW / 1.5 / 2.0 / 3.0 HP

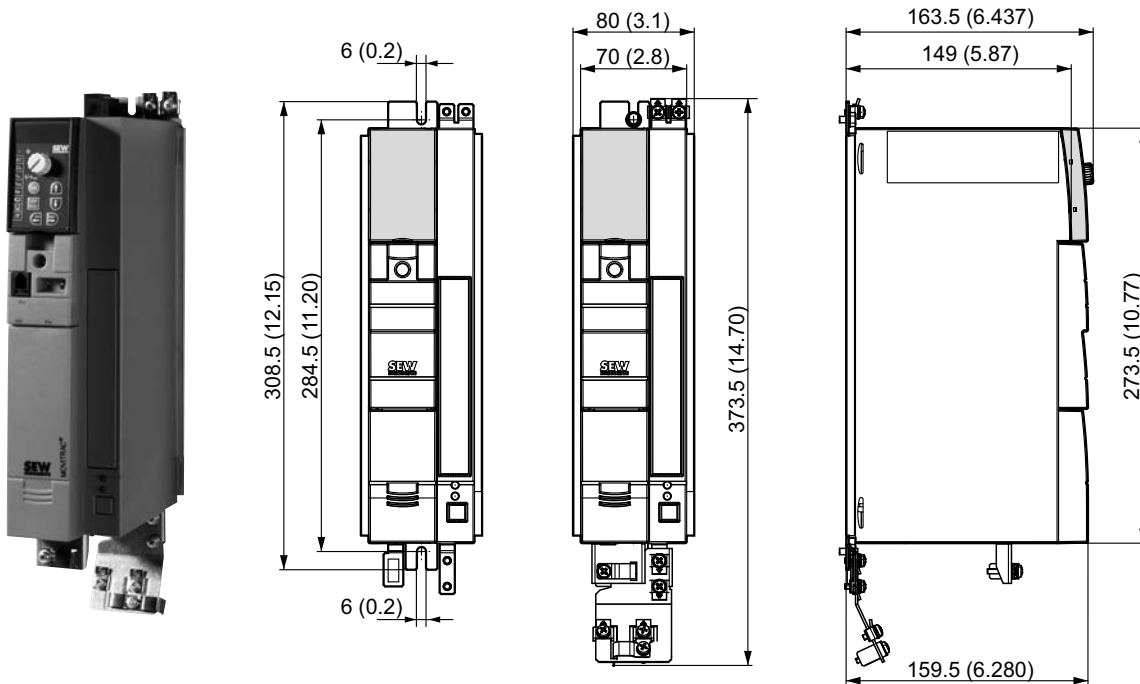

MOVITRAC® MC07B (1-phase power supply)		0011-2B1-4-00	0015-2B1-4-00	0022-2B1-4-00
Part number		828 496 2	828 497 0	828 498 9
INPUT				
Rated mains voltage	V_{line}	1 × AC 200 – 240 V		
Rated mains frequency	f_{mains}	50 / 60 Hz ± 5 %		
Rated mains current, 100 % operation	I_{mains}	AC 13.4 A	AC 16.7 A	AC 19.7 A
Rated mains current, 125 % operation	$I_{mains\ 125}$	AC 16.8 A	AC 20.7 A	AC 24.3 A
OUTPUT				
Output voltage	V_O	3 × 0 – V_{mains}		
Recommended motor power 100 % operation	P_{Mot}	1.1 kW / 1.5 HP	1.5 kW / 2.0 HP	2.2 kW / 3.0 HP
Recommended motor power 125 % operation	$P_{Mot\ 125}$	1.5 kW / 2.0 HP	2.2 kW / 3.0 HP	3.0 kW / 4.0 HP
Rated output current 100 % operation	I_N	AC 5.7 A	AC 7.3 A	AC 8.6 A
Rated output current 125 % operation	$I_{N\ 125}$	AC 7.1 A	AC 9.1 A	AC 10.8 A
Apparent output power 100 % operation	S_N	2.3 kVA	3.0 kVA	3.5 kVA
Apparent output power 125 % operation	$S_{N\ 125}$	2.9 kVA	3.7 kVA	4.3 kVA
Minimum permitted braking resistance value (4 quadrant operation)	R_{BW_min}	27 Ω		
GENERAL INFORMATION				
Power loss 100 % operation	P_V	70 W	90 W	105 W
Power loss 125 % operation	$P_{V\ 125}$	90 W	110 W	132 W
Current limitation		150 % I_N for at least 60 seconds		
Terminal cross section / tightening torque	Terminals	4 mm ² / AWG12 / 0.5 Nm / 4 lb in		
Dimensions	W × H × D	80 × 273.5 × 163.5 mm / 3.1 × 10.77 × 6.437 in		
Mass	m	2.2 kg / 4.9 lb		

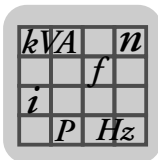

8.4.13 AC 230 V / 3-phase / size 0XS / 0.25 / 0.37 kW / 0.34 / 0.50 HP

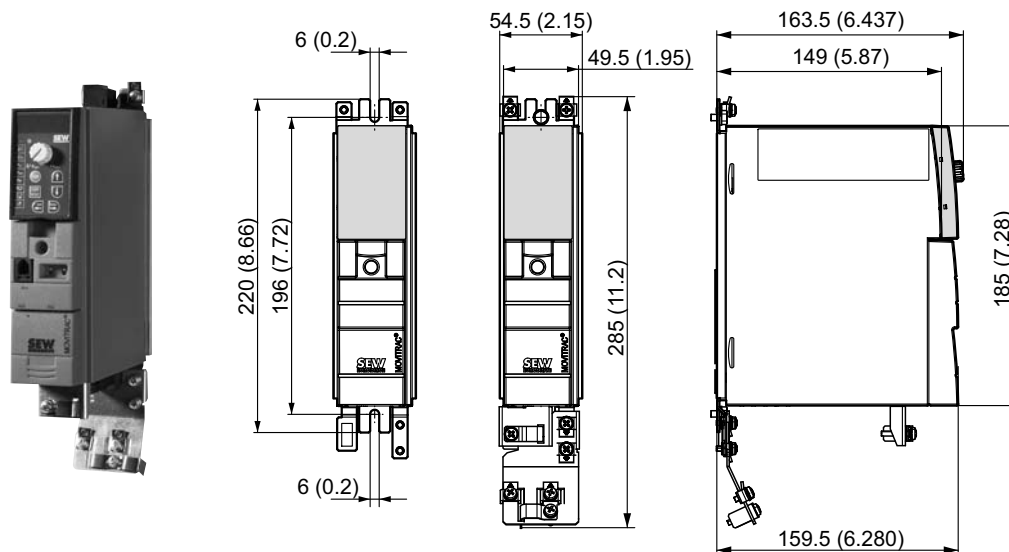

MOVITRAC® MC07B (3-phase power supply)		0003-2A3-4-00	0004-2A3-4-00
Part number		828 499 7	828 500 4
INPUT			
Rated mains voltage	V_{mains}	3 × AC 200 – 240 V	
Rated mains frequency	f_{mains}	50 / 60 Hz ± 5 %	
Rated mains current, 100 % operation	I_{mains}	AC 1.6 A	AC 2.0 A
Rated mains current, 125 % operation	$I_{\text{mains 125}}$	AC 1.9 A	AC 2.4 A
OUTPUT			
Output voltage	V_O	3 × 0 – V_{mains}	
Recommended motor power 100 % operation	P_{Mot}	0.25 kW / 0.34 HP	0.37 kW / 0.50 HP
Recommended motor power 125 % operation	$P_{\text{Mot 125}}$	0.37 kW / 0.50 HP	0.55 kW / 0.74 HP
Rated output current 100 % operation	I_N	AC 1.7 A	AC 2.5 A
Rated output current 125 % operation	$I_{N 125}$	AC 2.1 A	AC 3.1 A
Apparent output power 100 % operation	S_N	0.7 kVA	1.0 kVA
Apparent output power 125 % operation	$S_{N 125}$	0.9 kVA	1.3 kVA
Minimum permitted braking resistance value (4 quadrant operation)	$R_{\text{BW_min}}$	27 Ω	
GENERAL INFORMATION			
Power loss 100 % operation	P_V	35 W	40 W
Power loss 125 % operation	$P_{V 125}$	40 W	50 W
Current limitation		150 % I_N for at least 60 seconds	
Terminal cross section / tightening torque	Terminals	4 mm ² / AWG12 / 0.5 Nm / 4 lb in	
Dimensions	W × H × D	54.5 × 185 × 163.5 mm / 2.15 × 7.28 × 6.437 in	
Mass	m	1.3 kg / 2.9 lb	

8.4.14 AC 230 V / 3-phase / size 0S / 0.55 / 0.75 kW / 0.74 / 1.0 HP

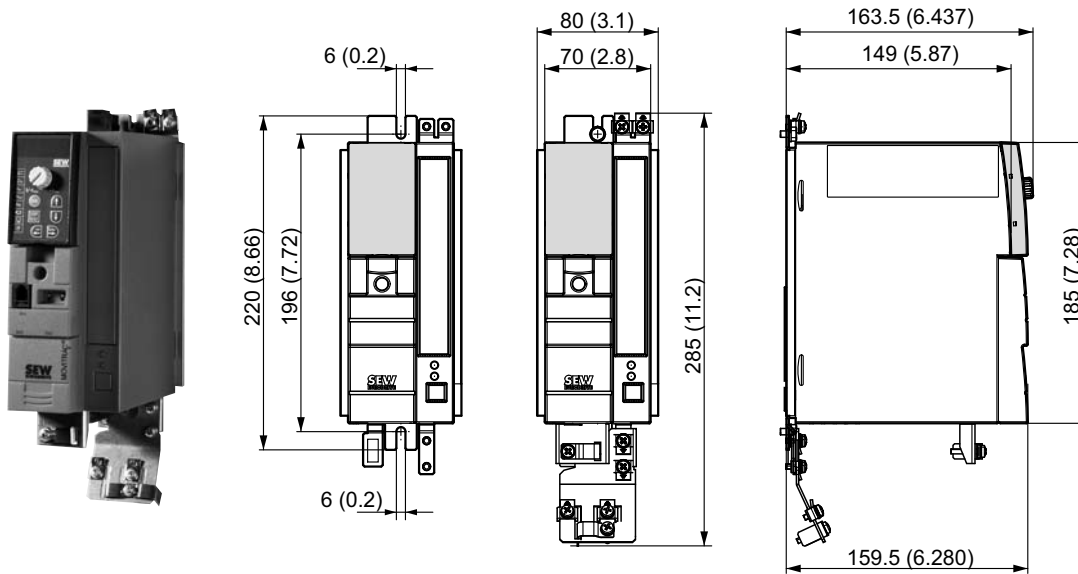

MOVITRAC® MC07B (3-phase power supply)		0005-2A3-4-x0	0008-2A3-4-x0
Part number, standard unit (-00)		828 501 2	828 502 0
Part number "Safe stop" (-S0) ¹⁾		829 987 0	829 988 9
INPUT			
Rated mains voltage	V_{mains}	3 × AC 200 – 240 V	
Rated mains frequency	f_{mains}	50 / 60 Hz ± 5 %	
Rated mains current, 100 % operation	I_{mains}	AC 2.8 A	AC 3.3 A
Rated mains current, 125 % operation	$I_{mains 125}$	AC 3.4 A	AC 4.1 A
OUTPUT			
Output voltage	V_O	3 × 0 – V_{mains}	
Recommended motor power 100 % operation	P_{Mot}	0.55 kW / 0.74 HP	0.75 kW / 1.0 HP
Recommended motor power 125 % operation	$P_{Mot 125}$	0.75 kW / 1.0 HP	1.1 kW / 1.5 HP
Rated output current 100 % operation	I_N	AC 3.3 A	AC 4.2 A
Rated output current 125 % operation	$I_{N 125}$	AC 4.1 A	AC 5.3 A
Apparent output power 100 % operation	S_N	1.4 kVA	1.7 kVA
Apparent output power 125 % operation	$S_{N 125}$	1.7 kVA	2.1 kVA
Minimum permitted braking resistance value (4 quadrant operation)	R_{BW_min}	27 Ω	
GENERAL INFORMATION			
Power loss 100 % operation	P_V	50 W	60 W
Power loss 125 % operation	$P_{V 125}$	60 W	75 W
Current limitation		150 % I_N for at least 60 seconds	
Terminal cross section / tightening torque	Terminals	4 mm ² / AWG12 / 0.5 Nm / 4 lb in	
Dimensions	W × H × D	80 × 185 × 163.5 mm / 3.1 × 7.28 × 6.437 in	
Mass	m	1.5 kg / 3.3 lb	

1) The unit type MC07B...-S0 must always be supplied by an external DC 24 V power supply unit.

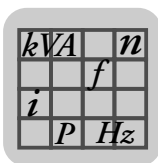

8.4.15 AC 230 V / 3-phase / size 0L / 1.1 / 1.5 / 2.2 kW / 1.5 / 2.0 / 3.0 HP

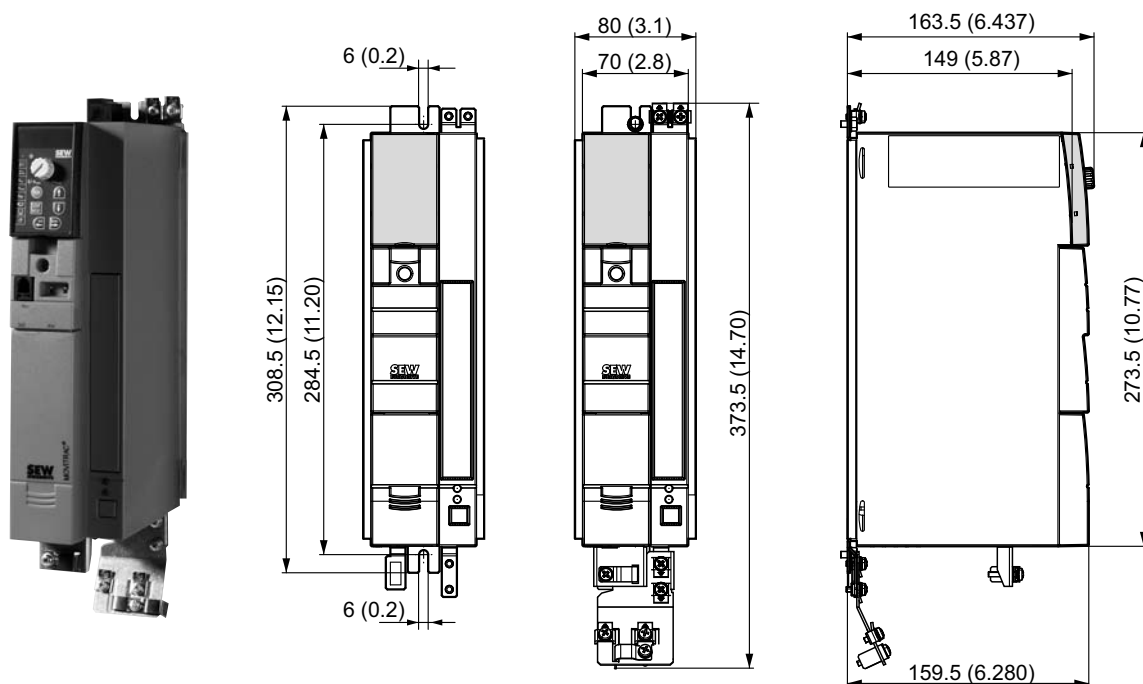

MOVITRAC® MC07B (3-phase power supply)		0011-2A3-4-00	0015-2A3-4-00	0022-2A3-4-00
Part number standard design (-00)		828 503 9	828 504 7	828 505 5
Part number "Safe technology" (-S0) ¹⁾		829 989 7	829 990 0	829 991 9
INPUT				
Rated mains voltage	V_{mains}	3 × AC 200 – 240 V		
Rated mains frequency	f_{mains}	50 / 60 Hz ± 5 %		
Rated mains current, 100 % operation	I_{mains}	AC 5.1 A	AC 6.4 A	AC 7.6 A
Rated mains current, 125 % operation	$I_{\text{mains 125}}$	AC 6.3 A	AC 7.9 A	AC 9.5 A
OUTPUT				
Output voltage	V_O	3 × 0 – V_{mains}		
Recommended motor power 100 % operation	P_{Mot}	1.1 kW / 1.5 HP	1.5 kW / 2.0 HP	2.2 kW / 3.0 HP
Recommended motor power 125 % operation	$P_{\text{Mot 125}}$	1.5 kW / 2.0 HP	2.2 kW / 3.0 HP	3.0 kW / 4.0 HP
Rated output current 100 % operation	I_N	AC 5.7 A	AC 7.3 A	AC 8.6 A
Rated output current 125 % operation	$I_{N 125}$	AC 7.1 A	AC 9.1 A	AC 10.8 A
Apparent output power 100 % operation	S_N	2.3 kVA	3.0 kVA	3.5 kVA
Apparent output power 125 % operation	$S_{N 125}$	2.9 kVA	3.7 kVA	4.3 kVA
Minimum permitted braking resistance value (4 quadrant operation)	$R_{\text{BW_min}}$	27 Ω		
GENERAL INFORMATION				
Power loss 100 % operation	P_V	75 W	90 W	105 W
Power loss 125 % operation	$P_{V 125}$	90 W	110 W	140 W
Current limitation		150 % I_N for at least 60 seconds		
Terminal cross section / tightening torque	Terminals	4 mm ² / AWG12 / 0.5 Nm / 4 lb in		
Dimensions	W × H × D	80 × 273.5 × 163.5 mm / 3.1 × 10.77 × 6.437 in		
Mass	m	2.2 kg / 4.9 lb		

1) The unit type MC07B...-S0 must always be supplied by an external DC 24 V power supply unit.

8.4.16 AC 230 V / 3-phase / size 1 / 3.7 kW / 5.0 HP

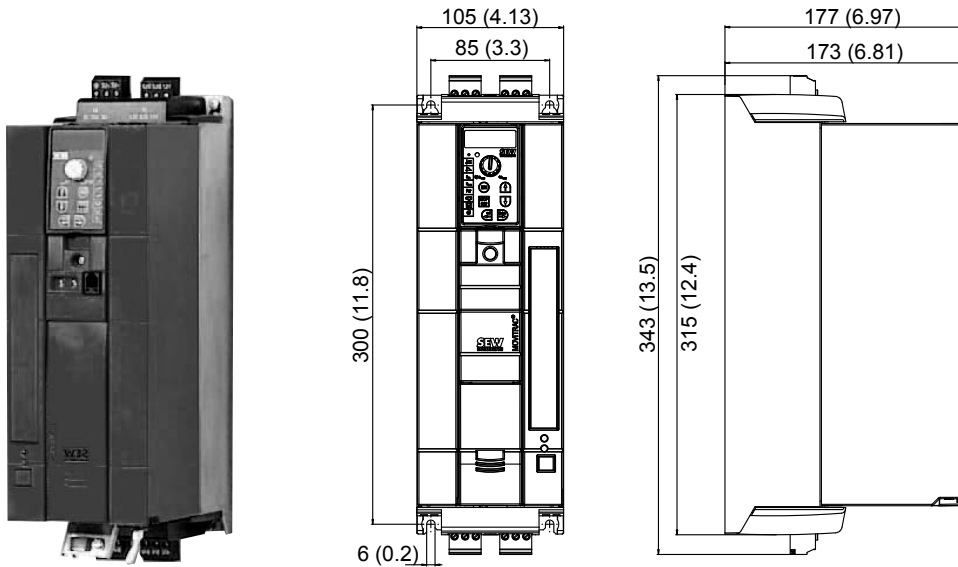

MOVITRAC® MC07B (3-phase power supply)		0037-2A3-4-00
Part number		828 506 3
INPUT		
Rated mains voltage	V_{mains}	3 × AC 200 – 240 V
Rated mains frequency	f_{mains}	50 / 60 Hz ± 5 %
Rated mains current, 100 % operation	I_{mains}	AC 12.9 A
Rated mains current, 125 % operation	$I_{mains\ 125}$	AC 16.1 A
OUTPUT		
Output voltage	V_O	3 × 0 – V_{mains}
Recommended motor power 100 % operation	P_{Mot}	3.7 kW / 5.0 HP
Recommended motor power 125 % operation	$P_{Mot\ 125}$	5.5 kW / 7.4 HP
Rated output current 100 % operation	I_N	AC 14.5 A
Rated output current 125 % operation	$I_{N\ 125}$	AC 18.1 A
Apparent output power 100 % operation	S_N	5.8 kVA
Apparent output power 125 % operation	$S_{N\ 125}$	7.3 kVA
Minimum permitted braking resistance value (4 quadrant operation)	R_{BW_min}	27 Ω
GENERAL INFORMATION		
Power loss 100 % operation	P_V	210 W
Power loss 125 % operation	$P_{V\ 125}$	270 W
Current limitation		150 % I_N for at least 60 seconds
Terminal cross section / tightening torque	Terminals	4 mm ² / AWG12 / 0.6 Nm / 5 lb in
Dimensions	W × H × D	105 × 315 × 173 mm / 4.13 × 12.4 × 6.81 in
Mass	m	3.5 kg / 7.7 lb

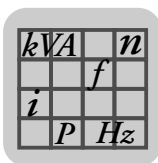

8.4.17 AC 230 V / 3-phase / size 2 / 5.5 / 7.5 kW / 7.4 / 10 HP

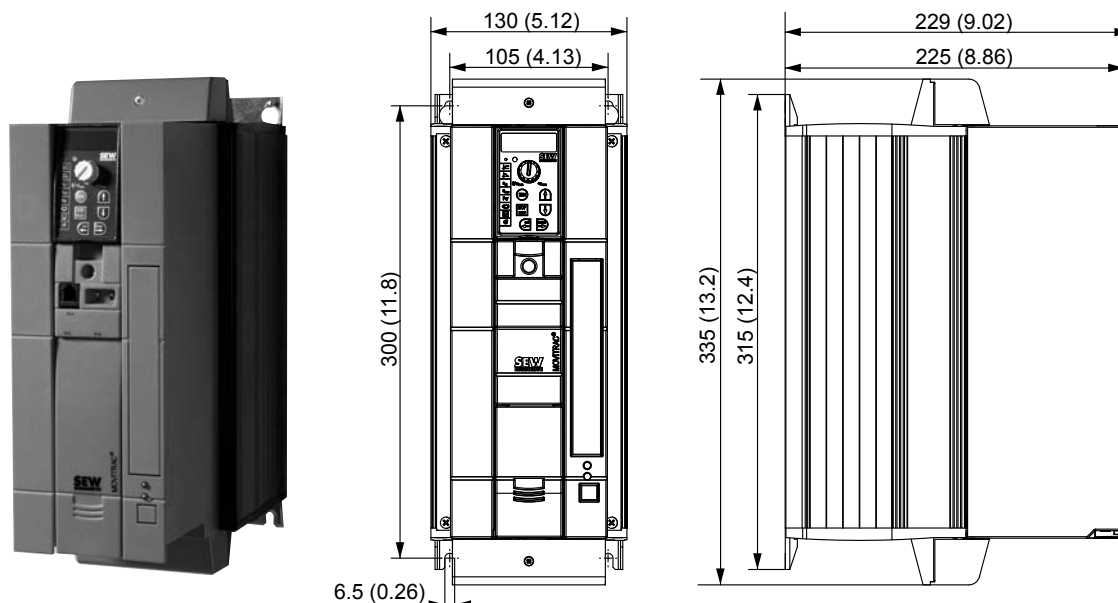

MOVITRAC® MC07B (3-phase power supply)		0055-2A3-4-00	0075-2A3-4-00
Part number		828 507 1	828 509 8
INPUT			
Rated mains voltage	V_{mains}	3 × AC 200 – 240 V	
Rated mains frequency	f_{mains}	50 / 60 Hz ± 5 %	
Rated mains current, 100 % operation	I_{mains}	AC 19.5 A	AC 27.4 A
Rated mains current, 125 % operation	$I_{\text{mains 125}}$	AC 24.4 A	AC 34.3 A
OUTPUT			
Output voltage	V_{O}	3 × 0 – V_{mains}	
Recommended motor power 100 % operation	P_{Mot}	5.5 kW / 7.4 HP	7.5 kW / 10 HP
Recommended motor power 125 % operation	$P_{\text{Mot 125}}$	AC 7.5 kW / 10 HP	11 kW / 15 HP
Rated output current 100 % operation	I_{N}	AC 22 A	AC 29 A
Rated output current 125 % operation	$I_{\text{N 125}}$	AC 27.5 A	AC 36.3 A
Apparent output power 100 % operation	S_{N}	8.8 kVA	11.6 kVA
Apparent output power 125 % operation	$S_{\text{N 125}}$	11.0 kVA	14.5 kVA
Minimum permitted braking resistance value (4 quadrant operation)	$R_{\text{BW_min}}$	12 Ω	
GENERAL INFORMATION			
Power loss 100 % operation	P_{V}	300 W	380 W
Power loss 125 % operation	$P_{\text{V 125}}$	375 W	475 W
Current limitation		150 % I_{N} for at least 60 seconds	
Terminal cross section / tightening torque	Terminals	4 mm ² / AWG12 / 1.5 Nm / 13 lb in	
Dimensions	W × H × D	130 × 335 × 229 mm / 5.12 × 13.2 × 9.02 in	
Mass	m	6.6 kg / 15 lb	

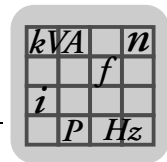

8.4.18 AC 230 V / 3-phase / size 3 / 11 / 15 kW / 15 / 20 HP

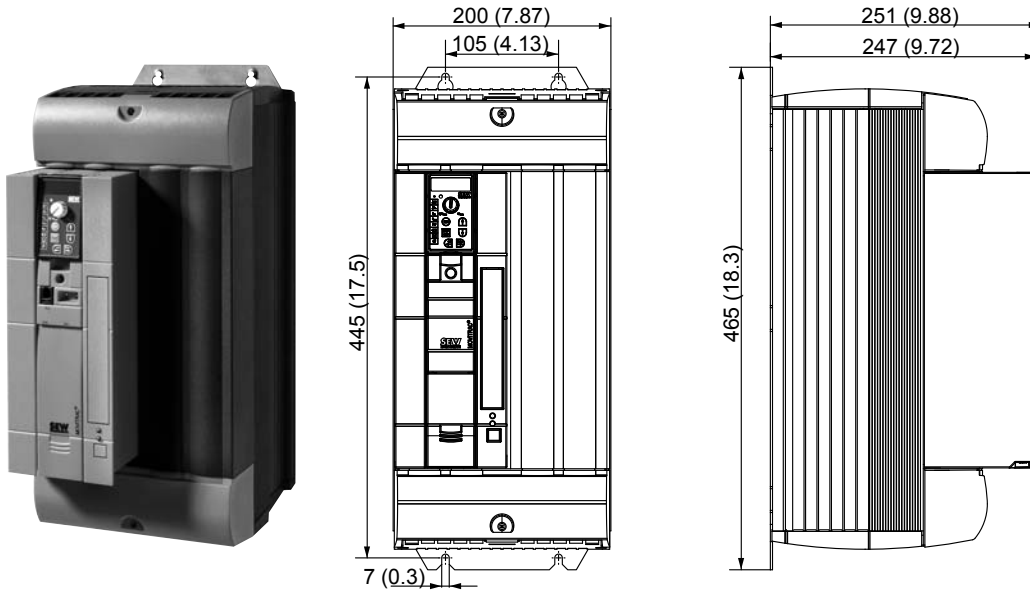

MOVITRAC® MC07B (3-phase power supply)		0110-203-4-00	0150-203-4-00
Part number		828 510 1	828 512 8
INPUT			
Rated mains voltage	V_{mains}	3 × AC 200 – 240 V	
Rated mains frequency	f_{mains}	50 / 60 Hz ± 5 %	
Rated mains current, 100 % operation	I_{mains}	AC 40.0 A	AC 48.6 A
Rated mains current, 125 % operation	$I_{\text{mains 125}}$	AC 50.0 A	AC 60.8 A
OUTPUT			
Output voltage	V_{O}	3 × 0 – V_{mains}	
Recommended motor power 100 % operation	P_{Mot}	11 kW / 15 HP	15 kW / 20 HP
Recommended motor power 125 % operation	$P_{\text{Mot 125}}$	15 kW / 20 HP	22 kW / 30 HP
Rated output current 100 % operation	I_{N}	AC 42 A	AC 54 A
Rated output current 125 % operation	$I_{\text{N 125}}$	AC 52.5 A	AC 67.5 A
Apparent output power 100 % operation	S_{N}	16.8 kVA	21.6 kVA
Apparent output power 125 % operation	$S_{\text{N 125}}$	21.0 kVA	26.9 kVA
Minimum permitted braking resistance value (4 quadrant operation)	$R_{\text{BW_min}}$	7.5 Ω	5.6 Ω
GENERAL INFORMATION			
Power loss 100 % operation	P_{V}	580 W	720 W
Power loss 125 % operation	$P_{\text{V 125}}$	720 W	900 W
Current limitation		150 % I_{N} for at least 60 seconds	
Terminal cross section / tightening torque	Terminals	6 mm ² / AWG10	10 mm ² / AWG8
		3.5 Nm / 31 lb in	
Dimensions	W × H × D	200 × 465 × 251 mm / 7.87 × 18.3 × 9.88 in	
Mass	m	15 kg / 33 lb	

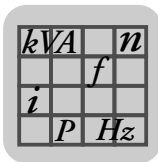

8.4.19 AC 230 V / 3-phase / size 4 / 22 / 30 kW / 30 / 40 HP

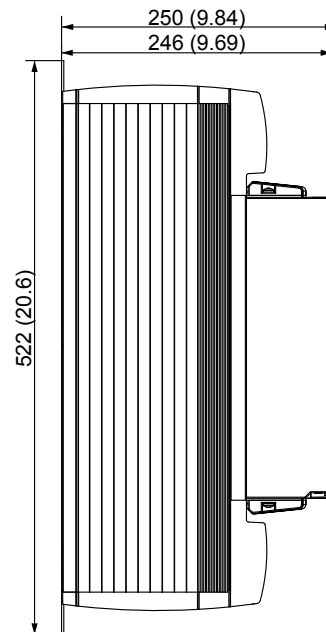
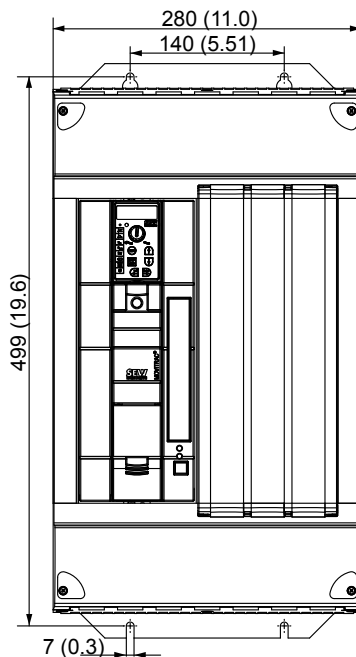

MOVITRAC® MC07B (3-phase power supply)		0220-203-4-00	0300-203-4-00
Part number		828 513 6	828 514 4
INPUT			
Rated mains voltage	V_{mains}	3 × AC 200 – 240 V	
Rated mains frequency	f_{mains}	50 / 60 Hz ± 5 %	
Rated mains current, 100 % operation	I_{mains}	AC 72 A	AC 86 A
Rated mains current, 125 % operation	$I_{\text{mains 125}}$	AC 90 A	AC 107 A
OUTPUT			
Output voltage	V_{O}	3 × 0 – V_{mains}	
Recommended motor power 100 % operation	P_{Mot}	22 kW / 30 HP	30 kW / 40 HP
Recommended motor power 125 % operation	$P_{\text{Mot 125}}$	30 kW / 40 HP	37 kW / 50 HP
Rated output current 100 % operation	I_{N}	AC 80 A	AC 95 A
Rated output current 125 % operation	$I_{\text{N 125}}$	AC 100 A	AC 118.8 A
Apparent output power 100 % operation	S_{N}	31.9 kVA	37.9 kVA
Apparent output power 125 % operation	$S_{\text{N 125}}$	39.9 kVA	47.4 kVA
Minimum permitted braking resistance value (4 quadrant operation)	$R_{\text{BW_min}}$	3 Ω	
GENERAL INFORMATION			
Power loss 100 % operation	P_{V}	1100 W	1300 W
Power loss 125 % operation	$P_{\text{V 125}}$	1400 W	1700 W
Current limitation		150 % I_{N} for at least 60 seconds	
Terminal cross section / tightening torque	Terminals	25 mm ² / AWG4	35 mm ² / AWG2
		14 Nm / 120 lb in	
Dimensions	W × H × D	280 × 522 × 250 mm / 11.0 × 20.6 × 9.84 in	
Mass	m	27 kg / 60 lb	

kVA	n
	f
i	
P	Hz

8.5 Front option FBG11B keypad

The FBG11B front option can be used for simple diagnostics and startup.

Part number	1820 635 2
Functions	<ul style="list-style-type: none"> • Display process values and status • Error memory and error reset queries • Display and set parameters • Backup and transfer of parameter sets • Easy-to-use startup menu for SEW and non-SEW motors • Manual control of MOVITRAC® B
Features	<ul style="list-style-type: none"> • 5-digit, 7-segment display / 6 buttons / 8 icons / speed control module • Selection of short or long menu • Can be plugged onto the inverter (during operation) • Degree of protection IP20 (EN 60529)



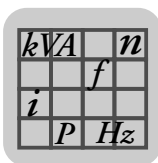

8.6 FSC11B communication module

The FSC11B communication module enables communication with other units. These may include: PC, operator terminals, MOVITRAC® or MOVIDRIVE®.

Part number	1820 716 2
Functions	<ul style="list-style-type: none"> • Communication with PLC / MOVITRAC®B / MOVIDRIVE® / PC • Operation / parameter setting / service (PC) • The options FSC11B and FIO11B are installed at the same fastening place and therefore cannot be used simultaneously.
Features	<ul style="list-style-type: none"> • RS-485 (one interface): Plug-in terminals and service interface (RJ10 socket) • CAN-based system bus (SBus) (plug-in terminals) • Supported protocols: MOVILINK® / SBus / RS-485 / CANopen

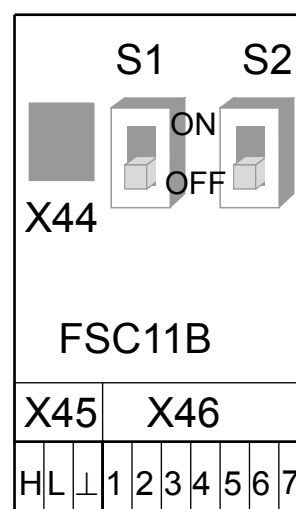
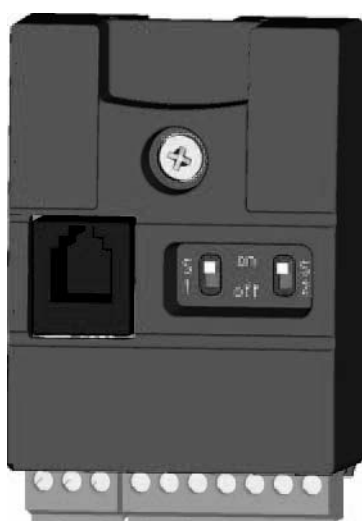

Function	Terminal	Designation	Data
System bus (SBus)	X46:1	SC11: SBus High	CAN bus according to CAN specification 2.0, parts A and B, transmission technology according to ISO 11898, max. 64 stations, terminating resistor (120 Ω) can be activated using DIP switch S1 . Terminal cross-section: 1.5 mm ² (AWG15) without conductor end sleeves 1.0 mm ² (AWG17) with conductor end sleeves
	X46:2	SC12: SBus Low	
	X46:3	GND: Reference potential	
	X46:4	SC21: SBus High	
	X46:5	SC22: SBus Low	
	X46:6	GND: Reference potential	
	X46:7	24VIO: Auxiliary voltage / external voltage supply	
RS-485 interface	X45:H X45:L X45:⊥	ST11: RS-485+ ST12: RS-485- GND: Reference potential	EIA standard, 9.6 kBaud, max. 32 stations Maximum cable length 200 m (656 ft) Dynamic terminating resistor with fixed installation Terminal cross-section: – 1.5 mm ² (AWG15) without conductor end sleeves – 1.0 mm ² (AWG17) with conductor end sleeves
	X44 RJ10	Service interface	

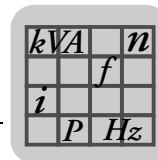

8.7 FIO11B analog module

Part number 1820 637 9

8.7.1 Description

The FIO11B analog module upgrades the basic version with the following interfaces:

- Setpoint input
- Analog output
- RS-485 interface
- The options FIO11B, FSC11B and FIO21B are mounted on the same fastening place and therefore cannot be used simultaneously.



8.7.2 Electronics data FIO11B analog module

Function	Terminal	Designation	Data
Setpoint input ¹⁾	X40:1 X40:2	AI2: Voltage input GND: Reference potential	–10 – +10 V $R_i > 40 \text{ k}\Omega$ Resolution 10 bit Sampling time 5 ms
Analog output / alternative as current output or voltage output	X40:3 X40:4 X40:5	GND: Reference potential AOV1: Voltage output AOC1: Current output	0 – +10 V / $I_{\max} = 2 \text{ mA}$ 0 (4) – 20 mA Resolution 10 bit Sampling time 5 ms Short-circuit proof, protected against external voltage up to 30 V Load impedance $R_L \leq 750 \Omega$
RS-485 interface	X45:H X45:L X45:⊥ X44 RJ10	ST11: RS-485+ ST12: RS-485– GND: Reference potential Service interface	EIA standard, 9.6 kBaud, max. 32 stations Maximum cable length 200 m (656 ft) Dynamic terminating resistor with fixed installation Terminal cross-section: – 1.5 mm ² (AWG15) without conductor end sleeves – 1.0 mm ² (AWG17) with conductor end sleeves Connection: Only for service purposes, solely for point-to-point connection Maximum cable length 3 m (10 ft)

1) If the setpoint input is not used, it should be set to GND. Otherwise a measured input voltage of –1 V ... +1 V is set.



8.8 FIO21B digital module

Part number 1822 541 1

8.8.1 Description

The FIO21B digital module upgrades the basic unit with the following interfaces:

- 7 additional binary inputs DI10 – DI16
- RS-485 service interface
- CAN-based system bus (SBus), plug-in terminals
- The options FIO11B, FSC11B and FIO21B are mounted on the same fastening place and therefore cannot be used simultaneously.

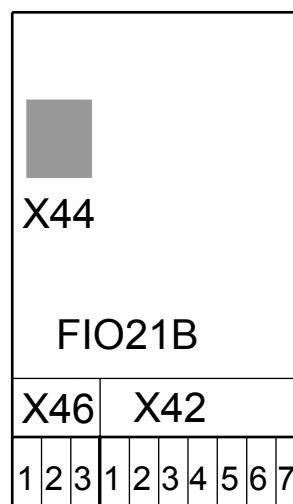

8.8.2 Electronics data of the FIO21B digital module

Function	Terminal	Designation	Data
Binary inputs	X42:1 X42:2 X42:3 X42:4 X42:5 X42:6 X42:7	DI10 DI11 DI12 DI13 DI14 DI15 DI16	$R_i = 3 \text{ k}\Omega$, $I_E = 10 \text{ mA}$, sampling interval 5 ms, PLC compatible Signal level according to EN 61131-2 type 1 or 3: <ul style="list-style-type: none"> • +11 V – +30 V: Contact closed • –3 V – +5 V: Contact open Factory set to "no function"
Service interface	X44 RJ10	Service interface	EIA standard, 9.6 kBaud Connection: Only for service purposes, solely for point-to-point connection Maximum cable length 3 m (10 ft)
System bus (SBus)	X46:1 X46:2 X46:3	SC11: CAN High SC12: CAN Low GND: Reference potential	CAN bus to CAN specification 2.0, parts A and B Transmission technology according to ISO 11898, max. 64 stations Bus termination possible between SC11 and SC12 with enclosed 120 Ω resistor. Terminal cross-section: <ul style="list-style-type: none"> • 1.5 mm² (AWG15) without conductor end sleeves • 1.0 mm² (AWG17) with conductor end sleeves



Index

A

Ambient temperature	84
Analog module FIO11B.....	38, 42
Analog setpoint specification	57
Auxiliary voltage output.....	86

B

Bimetallic switch TH.....	36
Binary inputs	19, 86
Binary output.....	86
Binary outputs	19
Brake rectifier	
Connection.....	37
Braking resistor, connection.....	18
BW braking resistor, connection	36

C

Cable cross-section	18
Cable length	
SBus	41
Cable lengths	18
Cable length, RS-485.....	42
Cable specification, SBus	39
CE-marking	83
Changing parameters, FBG11B keypad	49
class B limit	20
Climate class.....	84
Cold Plate	33
Communication interface FSC11B.....	38, 108
Connection braking resistor	18
Contactors	18
CSA.....	83
cUL.....	83

D

Data backup.....	48, 72
DBG60B.....	72
FBG11B.....	72
MOVITOOLS® MotionStudio.....	73
UBP11A	72
Deactivating EMC capacitors.....	33
Degree of protection	84
Direction of rotation	51
Duty cycle	84

E

Earth-leakage circuit breaker	20
Earth-leakage monitor.....	18
Electronics data	86
Electronics service	81
Electronics shield clamps.....	29
EMC limits.....	20
EMC-compliant installation	17
Enter (FBG11B keypad).....	47
Extended storage.....	82

External DC 24 V voltage supply.....	86
External setpoint selection	51

F

Fault	
F01 Overcurrent	78
F03 Ground fault	78
F04 Brake chopper.....	78
F06 Mains phase failure	78
F07 DC link overvoltage.....	78
F08 Speed monitoring.....	78
F09 Startup error	78
F10 ILL0P	79
F11 Overtemperature	79
F113 Wire breakage analog input	81
F17 ... F24 System error	79
F25 EEPROM.....	79
F26 External terminal	79
F31 TF sensor tripped.....	79
F32 Index overflow.....	79
F34 Ramp timeout.....	79
F36 Option missing	80
F37 Watchdog timer	80
F38 System software.....	80
F43 RS-485 timeout	80
F44 Unit utilization.....	80
F45 Initialization	80
F47 System bus 1 timeout.....	80
F77 Control word.....	80
F81 Start condition	80
F82 Open output	80
F84 UL motor protection.....	81
F94 EEPROM checksum	81
F97 Copy error	81
Fault memory	76
Fault, FBG11B keypad	49
FBG speed control module.....	48
FBG11B keypad	47, 107
Functions.....	47
Operation.....	48
Startup.....	52
Status displays	74
Status of binary inputs/outputs	74
FIO11B analog module	38, 42, 109, 110
Fixed setpoint	48
Fixed setpoints	59
FKE EMC-module	24
Front option FBG11B keypad.....	107
Front option FIO11B analog module	109, 110
Front option FSC11B communication	108
FSC11B communication interface.....	38, 108

G

GOST-R	83
Group drive.....	54



Index

H			
HD output choke	23	Parameter menu	48
HF output filter	22	PC startup	55
		PE input connection	20
		Pollution class	84
		Power shield clamps	29
I			
Immediate switch-off	76	R	
Input contactor	21	Ramp down	48
Installation altitude	85	Ramp up	48
Installation notes	16	Relay output	86
Interference emission	19, 84	Repair service	81
Interference immunity	84	Reset	77
Inverter status	48	Basic unit	77
IT systems	18, 33	Interface	77
		Keypad	77
		Return code	
K		19 Parameter lock active	73
Keypad FBG11B	47	20 Factory setting in progress	73
Functions	47	23 Option card missing	73
Operation	48	27 Option card missing	73
Startup	52	28 Controller inhibit required	73
		29 Invalid value for parameter	73
		32 Enable	73
		34 Error during execution	73
		38 FBG11B incorrect data set	73
		Return codes	73
		RS-485, installation	42
		RUN (FBG11B keypad)	47
L		S	
Leakage current	84	Safety contact	87
LED, flash codes	75	Safety notes	7
Limit value class	20	Scope of delivery	28
Line protection	20	Set direction of rotation	51
List of faults	78	Setpoint input	86
Loose items	28	Setpoint selection, external	51
		Setpoint specification, analog	57
		Setpoint speed	51
		Setting the speed manually	50
		Shield plate for control electronics	29
		Shield plate for power section	29
		Speed control module	48
		Speed control module MBG11A	43
		Speed control, manual	50
		Speed, maximum	50
		Speed, minimum	50
		Starting the motor	57
		Startup	
		Brief description	44
		FBG11B keypad	52
		Hoist applications	45
		Notes	45
		PC	55
		Preliminary work and resources	46
		Prerequisite	45
		Start, motor	57
		Status display	
		FBG11B keypad	49
		Status displays	
		Keypad	74
M			
Manual operation with FBG11B keypad	50		
Manual speed control	50		
Maximum setpoint	48		
Maximum speed	50		
MBG11A speed control module	43		
Minimum clearance	17		
Minimum speed	50		
Motor lead	18		
Motor startup	48		
Mounting position	17		
MOVITOLS® MotionStudio, startup	55		
Multi-motor drive	54		
N			
Nameplate	15		
ND line choke	21		
NF line filter	20, 21		
O			
out (FBG11B keypad)	47		
Output current	48		
Output frequency	48		
Overvoltage category	84		
P			
Parameter list	61		



LED, flash codes.....	75
Status of binary inputs/outputs	74
Stop.....	76
STOP / RESET (FBG11B keypad)	47
Storage temperature	84
Supply system lead.....	18
Switch-off response	
Immediate switch-off.....	76
stop	76
Switch-off responses.....	76
Systembus (SBus), installation	40

T

Technical data

AC 230 V / 1-phase / size 0L	99
AC 230 V / 1-phase / size 0S.....	98
AC 230 V / 1-phase / size 0XS	97
AC 230 V / 3-phase / size 0L	102
AC 230 V / 3-phase / size 0XS	100
AC 230 V / 3-phase / size 2	104
AC 230 V / 3-phase / size 3	105
AC 230 V / 3-phase / size 4	106
AC 400/500 V / 3-phase / size 0L	91
AC 400/500 V / 3-phase / size 0S.....	90
AC 400/500 V / 3-phase / size 0XS	89
AC 400/500 V / 3-phase / size 2	93
AC 400/500 V / 3-phase / size 2S.....	92
AC 400/500 V / 3-phase / size 3	94
AC 400/500 V / 3-phase / size 4	95
AC 400/500 V / 3-phase / size 5	96
Technical data, general.....	84
Technical data, overview	88
Terminal response times.....	87
TF thermistor.....	36, 86
TH bimetallic switch	36
Thermistor TF	36
Timeout (warning).....	77
Touch guard.....	31
Transport temperature	84
Type of cooling.....	84

U

UL approval.....	83
UL compliant installation	26
ULF11A folding ferrites	21
Unit design	11
Size 0XS / 0S / 0L.....	11
Size 1 / 2S / 2	12
Size 3.....	13
Size 4 / 5.....	14
Unit designation	15
Unit information.....	76
Unit status	15
Unit status codes	75

V

VFC.....	53
V/f.....	53

W

Warnings, FBG11B keypad.....	49
Wiring diagram	35



Address List

Address List

Germany			
Headquarters Production Sales	Bruchsal	SEW-EURODRIVE GmbH & Co KG Ernst-Blickle-Straße 42 D-76646 Bruchsal P.O. Box Postfach 3023 • D-76642 Bruchsal	Tel. +49 7251 75-0 Fax +49 7251 75-1970 http://www.sew-eurodrive.de sew@sew-eurodrive.de
Service Competence Center	Central	SEW-EURODRIVE GmbH & Co KG Ernst-Blickle-Straße 1 D-76676 Graben-Neudorf	Tel. +49 7251 75-1710 Fax +49 7251 75-1711 sc-mitte@sew-eurodrive.de
	North	SEW-EURODRIVE GmbH & Co KG Alte Ricklinger Straße 40-42 D-30823 Garbsen (near Hannover)	Tel. +49 5137 8798-30 Fax +49 5137 8798-55 sc-nord@sew-eurodrive.de
	East	SEW-EURODRIVE GmbH & Co KG Dänkritzer Weg 1 D-08393 Meerane (near Zwickau)	Tel. +49 3764 7606-0 Fax +49 3764 7606-30 sc-ost@sew-eurodrive.de
	South	SEW-EURODRIVE GmbH & Co KG Domagkstraße 5 D-85551 Kirchheim (near München)	Tel. +49 89 909552-10 Fax +49 89 909552-50 sc-sued@sew-eurodrive.de
	West	SEW-EURODRIVE GmbH & Co KG Siemensstraße 1 D-40764 Langenfeld (near Düsseldorf)	Tel. +49 2173 8507-30 Fax +49 2173 8507-55 sc-west@sew-eurodrive.de
	Electronics	SEW-EURODRIVE GmbH & Co KG Ernst-Blickle-Straße 42 D-76646 Bruchsal	Tel. +49 7251 75-1780 Fax +49 7251 75-1769 sc-elektronik@sew-eurodrive.de
	Drive Service Hotline / 24 Hour Service		
Additional addresses for service in Germany provided on request!			
France			
Production Sales Service	Hagenau	SEW-USOCOME 48-54 route de Soufflenheim B. P. 20185 F-67506 Hagenau Cedex	Tel. +33 3 88 73 67 00 Fax +33 3 88 73 66 00 http://www.usocome.com sew@usocome.com
Production	Forbach	SEW-EUROCOME Zone Industrielle Technopôle Forbach Sud B. P. 30269 F-57604 Forbach Cedex	Tel. +33 3 87 29 38 00
Assembly Sales Service	Bordeaux	SEW-USOCOME Parc d'activités de Magellan 62 avenue de Magellan - B. P. 182 F-33607 Pessac Cedex	Tel. +33 5 57 26 39 00 Fax +33 5 57 26 39 09
	Lyon	SEW-USOCOME Parc d'Affaires Roosevelt Rue Jacques Tati F-69120 Vaulx en Velin	Tel. +33 4 72 15 37 00 Fax +33 4 72 15 37 15
	Paris	SEW-USOCOME Zone industrielle 2 rue Denis Papin F-77390 Verneuil l'Etang	Tel. +33 1 64 42 40 80 Fax +33 1 64 42 40 88
Additional addresses for service in France provided on request!			



Algeria			
Sales	Alger	Réducom 16, rue des Frères Zagnoun Bellevue El-Harrach 16200 Alger	Tel. +213 21 8222-84 Fax +213 21 8222-84 reducom_sew@yahoo.fr
Argentina			
Assembly Sales Service	Buenos Aires	SEW EURODRIVE ARGENTINA S.A. Centro Industrial Garin, Lote 35 Ruta Panamericana Km 37,5 1619 Garin	Tel. +54 3327 4572-84 Fax +54 3327 4572-21 sewar@sew-eurodrive.com.ar http://www.sew-eurodrive.com.ar
Australia			
Assembly Sales Service	Melbourne	SEW-EURODRIVE PTY. LTD. 27 Beverage Drive Tullamarine, Victoria 3043	Tel. +61 3 9933-1000 Fax +61 3 9933-1003 http://www.sew-eurodrive.com.au enquires@sew-eurodrive.com.au
	Sydney	SEW-EURODRIVE PTY. LTD. 9, Sleigh Place, Wetherill Park New South Wales, 2164	Tel. +61 2 9725-9900 Fax +61 2 9725-9905 enquires@sew-eurodrive.com.au
Austria			
Assembly Sales Service	Wien	SEW-EURODRIVE Ges.m.b.H. Richard-Strauss-Strasse 24 A-1230 Wien	Tel. +43 1 617 55 00-0 Fax +43 1 617 55 00-30 http://www.sew-eurodrive.at sew@sew-eurodrive.at
Belarus			
Sales	Minsk	SEW-EURODRIVE BY RybalkoStr. 26 BY-220033 Minsk	Tel.+375 (17) 298 38 50 Fax +375 (17) 29838 50 sales@sew.by
Belgium			
Assembly Sales Service	Brüssel	SEW Caron-Vector Avenue Eiffel 5 B-1300 Wavre	Tel. +32 10 231-311 Fax +32 10 231-336 http://www.sew-eurodrive.be info@caron-vector.be
Service Competence Center	Industrial Gears	SEW Caron-Vector Rue de Parc Industriel, 31 BE-6900 Marche-en-Famenne	Tel. +32 84 219-878 Fax +32 84 219-879 http://www.sew-eurodrive.be service-wallonie@sew-eurodrive.be
	Antwerp	SEW Caron-Vector Glasstraat, 19 BE-2170 Merksem	Tel. +32 3 64 19 333 Fax +32 3 64 19 336 http://www.sew-eurodrive.be service-antwerpen@sew-eurodrive.be
Brazil			
Production Sales Service	Sao Paulo	SEW-EURODRIVE Brasil Ltda. Avenida Amâncio Gaiolli, 152 - Rodovia Presidente Dutra Km 208 Guarulhos - 07251-250 - SP SAT - SEW ATENDE - 0800 7700496	Tel. +55 11 2489-9133 Fax +55 11 2480-3328 http://www.sew-eurodrive.com.br sew@sew.com.br
Bulgaria			
Sales	Sofia	BEVER-DRIVE GmbH Bogdanovetz Str.1 BG-1606 Sofia	Tel. +359 2 9151160 Fax +359 2 9151166 bever@fastbg.net



Address List

Cameroon			
Sales	Douala	Electro-Services Rue Drouot Akwa B.P. 2024 Douala	Tel. +237 33 431137 Fax +237 33 431137
Canada			
Assembly Sales Service	Toronto	SEW-EURODRIVE CO. OF CANADA LTD. 210 Walker Drive Bramalea, ON L6T 3W1	Tel. +1 905 791-1553 Fax +1 905 791-2999 http://www.sew-eurodrive.ca l.watson@sew-eurodrive.ca
	Vancouver	SEW-EURODRIVE CO. OF CANADA LTD. Tilbury Industrial Park 7188 Honeyman Street Delta, BC V4G 1G1	Tel. +1 604 946-5535 Fax +1 604 946-2513 b.wake@sew-eurodrive.ca
	Montreal	SEW-EURODRIVE CO. OF CANADA LTD. 2555 Rue Leger Lasalle, PQ H8N 2V9	Tel. +1 514 367-1124 Fax +1 514 367-3677 a.peluso@sew-eurodrive.ca
Additional addresses for service in Canada provided on request!			
Chile			
Assembly Sales Service	Santiago de Chile	SEW-EURODRIVE CHILE LTDA. Las Encinas 1295 Parque Industrial Valle Grande LAMPA RCH-Santiago de Chile P.O. Box Casilla 23 Correo Quilicura - Santiago - Chile	Tel. +56 2 75770-00 Fax +56 2 75770-01 http://www.sew-eurodrive.cl ventas@sew-eurodrive.cl
China			
Production Assembly Sales Service	Tianjin	SEW-EURODRIVE (Tianjin) Co., Ltd. No. 46, 7th Avenue, TEDA Tianjin 300457	Tel. +86 22 25322612 Fax +86 22 25322611 info@sew-eurodrive.cn http://www.sew-eurodrive.cn
	Suzhou	SEW-EURODRIVE (Suzhou) Co., Ltd. 333, Suhong Middle Road Suzhou Industrial Park Jiangsu Province, 215021	Tel. +86 512 62581781 Fax +86 512 62581783 suzhou@sew-eurodrive.cn
	Guangzhou	SEW-EURODRIVE (Guangzhou) Co., Ltd. No. 9, JunDa Road East Section of GETDD Guangzhou 510530	Tel. +86 20 82267890 Fax +86 20 82267891 guangzhou@sew-eurodrive.cn
Assembly Sales Service	Shenyang	SEW-EURODRIVE (Shenyang) Co., Ltd. 10A-2, 6th Road Shenyang Economic Technological Development Area Shenyang, 110141	Tel. +86 24 25382538 Fax +86 24 25382580 shenyang@sew-eurodrive.cn
	Wuhan	SEW-EURODRIVE (Wuhan) Co., Ltd. 10A-2, 6th Road No. 59, the 4th Quanli Road, WEDA 430056 Wuhan	Tel. +86 27 84478398 Fax +86 27 84478388
	Xi'An	SEW-EURODRIVE (Xi'An) Co., Ltd. No. 12 Jinye 2nd Road Xi'An High-Technology Industrial Development Zone Xi'An 710065	Tel. +86 29 88241718 Fax +86 29 68686296 logistic-xa@sew-eurodrive.cn
Additional addresses for service in China provided on request!			



Colombia			
Assembly	Bogotá	SEW-EURODRIVE COLOMBIA LTDA.	Tel. +57 1 54750-50
Sales		Calle 22 No. 132-60	Fax +57 1 54750-44
Service		Bodega 6, Manzana B Santafé de Bogotá	http://www.sew-eurodrive.com.co sewcol@sew-eurodrive.com.co
Croatia			
Sales	Zagreb	KOMPEKS d. o. o.	Tel. +385 1 4613-158
Service		PIT Erdödy 4 II HR 10 000 Zagreb	Fax +385 1 4613-158 kompeks@inet.hr
Czech Republic			
Sales	Praha	SEW-EURODRIVE CZ S.R.O.	Tel. +420 255 709 601
		Business Centrum Praha Lužná 591 CZ-16000 Praha 6 - Vokovice	Fax +420 220 121 237 http://www.sew-eurodrive.cz sew@sew-eurodrive.cz
Denmark			
Assembly	Kopenhagen	SEW-EURODRIVEA/S	Tel. +45 43 9585-00
Sales		Geminivej 28-30	Fax +45 43 9585-09
Service		DK-2670 Greve	http://www.sew-eurodrive.dk sew@sew-eurodrive.dk
Egypt			
Sales	Cairo	Copam Egypt	Tel. +20 2 22566-299 + 1 23143088
Service		for Engineering & Agencies 33 El Hegaz ST, Heliopolis, Cairo	Fax +20 2 22594-757 http://www.copam-egypt.com/ copam@datum.com.eg
Service	Sharjah	Copam Middle East (FZC) Sharjah Airport International Free Zone P.O. Box 120709 Sharjah United Arab Emirates	Tel. +971 6 5578-488 Fax +971 6 5578-499 copam_me@eim.ae
Estonia			
Sales	Tallin	ALAS-KUUL AS	Tel. +372 6593230
		Reti tee 4 EE-75301 Peetri küla, Rae vald, Harjumaa	Fax +372 6593231 veiko.soots@alas-kuul.ee
Finland			
Assembly	Lahti	SEW-EURODRIVE OY	Tel. +358 201 589-300
Sales		Vesimäentie 4	Fax +358 3 780-6211
Service		FIN-15860 Hollola 2	sew@sew.fi http://www.sew-eurodrive.fi
Production	Karkkila	SEW Industrial Gears Oy	Tel. +358 201 589-300
Assembly		Valurinkatu 6, PL 8 FI-03600 Karkkila, 03601 Karkkila	Fax +358 201 589-310 sew@sew.fi http://www.sew-eurodrive.fi
Gabon			
Sales	Libreville	ESG Electro Services Gabun	Tel. +241 741059
		Feu Rouge Lalala 1889 Libreville Gabun	Fax +241 741059
Great Britain			
Assembly	Normanton	SEW-EURODRIVE Ltd.	Tel. +44 1924 893-855
Sales		Beckbridge Industrial Estate	Fax +44 1924 893-702
Service		P.O. Box No.1 GB-Normanton, West- Yorkshire WF6 1QR	http://www.sew-eurodrive.co.uk info@sew-eurodrive.co.uk



Address List

Greece			
Sales Service	Athen	Christ. Boznos & Son S.A. 12, Mavromichali Street P.O. Box 80136, GR-18545 Piraeus	Tel. +30 2 1042 251-34 Fax +30 2 1042 251-59 http://www.boznos.gr info@boznos.gr
Hong Kong			
Assembly Sales Service	Hong Kong	SEW-EURODRIVE LTD. Unit No. 801-806, 8th Floor Hong Leong Industrial Complex No. 4, Wang Kwong Road Kowloon, Hong Kong	Tel. +852 36902200 Fax +852 36902211 contact@sew-eurodrive.hk
Hungary			
Sales Service	Budapest	SEW-EURODRIVE Kft. H-1037 Budapest Kunigunda u. 18	Tel. +36 1 437 06-58 Fax +36 1 437 06-50 office@sew-eurodrive.hu
India			
Registered Office Assembly Sales Service	Vadodara	SEW-EURODRIVE India Private Limited Plot No. 4, GIDC POR Ramangamdi • Vadodara - 391 243 Gujarat	Tel. +91 265 3045200, +91 265 2831086 Fax +91 265 3045300, +91 265 2831087 http://www.seweurodriveindia.com sales@seweurodriveindia.com subodh.ladwa@seweurodriveindia.com
Assembly Sales Service	Chennai	SEW-EURODRIVE India Private Limited Plot No. K3/1, Sipcot Industrial Park Phase II Mambakkam Village Sriperumbudur - 602105 Kancheepuram Dist, Tamil Nadu	Tel. +91 44 37188888 Fax +91 44 37188811 c.v.shivkumar@seweurodriveindia.com
Ireland			
Sales Service	Dublin	Alperton Engineering Ltd. 48 Moyle Road Dublin Industrial Estate Glasnevin, Dublin 11	Tel. +353 1 830-6277 Fax +353 1 830-6458 info@alperton.ie http://www.alperton.ie
Israel			
Sales	Tel-Aviv	Liraz Handasa Ltd. Ahofer Str 34B / 228 58858 Holon	Tel. +972 3 5599511 Fax +972 3 5599512 http://www.liraz-handasa.co.il office@liraz-handasa.co.il
Italy			
Assembly Sales Service	Milano	SEW-EURODRIVE di R. Blicke & Co.s.a.s. Via Bernini,14 I-20020 Solaro (Milano)	Tel. +39 02 96 9801 Fax +39 02 96 799781 http://www.sew-eurodrive.it sewit@sew-eurodrive.it
Ivory Coast			
Sales	Abidjan	SICA Ste industrielle et commerciale pour l'Afrique 165, Bld de Marseille B.P. 2323, Abidjan 08	Tel. +225 2579-44 Fax +225 2584-36
Japan			
Assembly Sales Service	Iwata	SEW-EURODRIVE JAPAN CO., LTD 250-1, Shimoman-no, Iwata Shizuoka 438-0818	Tel. +81 538 373811 Fax +81 538 373814 http://www.sew-eurodrive.co.jp sewjapan@sew-eurodrive.co.jp



Korea			
Assembly Sales Service	Ansan-City	SEW-EURODRIVE KOREA CO., LTD. B 601-4, Banweol Industrial Estate 1048-4, Shingil-Dong Ansan 425-120	Tel. +82 31 492-8051 Fax +82 31 492-8056 http://www.sew-korea.co.kr master@sew-korea.co.kr
	Busan	SEW-EURODRIVE KOREA Co., Ltd. No. 1720 - 11, Songjeong - dong Gangseo-ku Busan 618-270	Tel. +82 51 832-0204 Fax +82 51 832-0230 master@sew-korea.co.kr
Latvia			
Sales	Riga	SIA Alas-Kuul Katlakalna 11C LV-1073 Riga	Tel. +371 7139253 Fax +371 7139386 http://www.alas-kuul.com info@alas-kuul.com
Lebanon			
Sales	Beirut	Gabriel Acar & Fils sarl B. P. 80484 Bourj Hammoud, Beirut	Tel. +961 1 4947-86 +961 1 4982-72 +961 3 2745-39 Fax +961 1 4949-71 ssacar@inco.com.lb
	Beirut	Middle East Drives S.A.L. (offshore) Sin El Fil. B. P. 55-378 Beirut	Tel. +961 1 494 786 Fax +961 1 494 971 philippe.acar@medrives.com
Lithuania			
Sales	Alytus	UAB Irseva Naujoji 19 LT-62175 Alytus	Tel. +370 315 79204 Fax +370 315 56175 info@irseva.lt http://www.sew-eurodrive.lt
Luxembourg			
Assembly Sales Service	Brüssel	CARON-VECTOR S.A. Avenue Eiffel 5 B-1300 Wavre	Tel. +32 10 231-311 Fax +32 10 231-336 http://www.sew-eurodrive.lu info@caron-vector.be
Malaysia			
Assembly Sales Service	Johore	SEW-EURODRIVE SDN BHD No. 95, Jalan Seroja 39, Taman Johor Jaya 81000 Johor Bahru, Johor West Malaysia	Tel. +60 7 3549409 Fax +60 7 3541404 sales@sew-eurodrive.com.my
Mexico			
Assembly Sales Service	Quéretaro	SEW-EURODRIVE MEXICO SA DE CV SEM-981118-M93 Tequisquiapan No. 102 Parque Industrial Quéretaro C.P. 76220 Quéretaro, México	Tel. +52 442 1030-300 Fax +52 442 1030-301 http://www.sew-eurodrive.com.mx scmexico@seweurodrive.com.mx
Morocco			
Sales	Casablanca	Afit 5, rue Emir Abdelkader MA 20300 Casablanca	Tel. +212 522618372 Fax +212 522618351 ali.alami@premium.net.ma



Address List

Netherlands			
Assembly Sales Service	Rotterdam	VECTOR Aandrijftechniek B.V. Industrieweg 175 NL-3044 AS Rotterdam Postbus 10085 NL-3004 AB Rotterdam	Tel. +31 10 4463-700 Fax +31 10 4155-552 http://www.vector.nu info@vector.nu
		VECTOR Aandrijftechniek B.V. Gelderhorst 10 NL-7207 BH Zutphen Industrieterrein de Revelhorst	Tel. +31 575 57 44 94 Fax +31 575 57 24 43 oost@vector.nu
		VECTOR Aandrijftechniek B.V. Mercuriusweg 8A NL-5971 LX Grubbenvorst	Tel. +31 77 36 61 873 Fax +31 77 36 62 109 zuid@vector.nu
		VECTOR Aandrijftechniek B.V. Weberstraat 74 NL-1446 VV Purmerend Industrieterrein "De Baansteer"	Tel. +31 299 66 63 38 Fax +31 299 47 60 55 noordwest@vector.nu
New Zealand			
Assembly Sales Service	Auckland	SEW-EURODRIVE NEW ZEALAND LTD. P.O. Box 58-428 82 Greenmount drive East Tamaki Auckland	Tel. +64 9 2745627 Fax +64 9 2740165 http://www.sew-eurodrive.co.nz sales@sew-eurodrive.co.nz
	Christchurch	SEW-EURODRIVE NEW ZEALAND LTD. 10 Settlers Crescent, Ferrymead Christchurch	Tel. +64 3 384-6251 Fax +64 3 384-6455 sales@sew-eurodrive.co.nz
Norway			
Assembly Sales Service	Moss	SEW-EURODRIVE A/S Solgaard skog 71 N-1599 Moss	Tel. +47 69 24 10 20 Fax +47 69 24 10 40 http://www.sew-eurodrive.no sew@sew-eurodrive.no
Peru			
Assembly Sales Service	Lima	SEW DEL PERU MOTORES REDUCTORES S.A.C. Los Calderos, 120-124 Urbanizacion Industrial Vulcano, ATE, Lima	Tel. +51 1 3495280 Fax +51 1 3493002 http://www.sew-eurodrive.com.pe sewperu@sew-eurodrive.com.pe
Poland			
Assembly Sales Service	Lodz	SEW-EURODRIVE Polska Sp.z.o.o. ul. Techniczna 5 PL-92-518 Łódź	Tel. +48 42 676 53 00 Fax +48 42 676 53 45 http://www.sew-eurodrive.pl sew@sew-eurodrive.pl
		24 Hour Service	Tel. +48 602 739 739 (+48 602 SEW SEW) serwis@sew-eurodrive.pl
Portugal			
Assembly Sales Service	Coimbra	SEW-EURODRIVE, LDA. Apartado 15 P-3050-901 Mealhada	Tel. +351 231 20 9670 Fax +351 231 20 3685 http://www.sew-eurodrive.pt infosew@sew-eurodrive.pt
Romania			
Sales Service	București	Sialco Trading SRL str. Madrid nr.4 011785 Bucuresti	Tel. +40 21 230-1328 Fax +40 21 230-7170 sialco@sialco.ro



Russia			
Assembly	St. Petersburg	ZAO SEW-EURODRIVE	Tel. +7 812 3332522 +7 812 5357142
Sales		P.O. Box 36	Fax +7 812 3332523
Service		195220 St. Petersburg Russia	http://www.sew-eurodrive.ru sew@sew-eurodrive.ru
Senegal			
Sales	Dakar	SENEMECA Mécanique Générale Km 8, Route de Rufisque B.P. 3251, Dakar	Tel. +221 338 494 770 Fax +221 338 494 771 senemeca@sentoo.sn
Serbia			
Sales	Beograd	DIPAR d.o.o. Ustanicka 128a PC Košum, IV floor SCG-11000 Beograd	Tel. +381 11 347 3244 / +381 11 288 0393 Fax +381 11 347 1337 office@dipar.co.yu
Singapore			
Assembly	Singapore	SEW-EURODRIVE PTE. LTD. No 9, Tuas Drive 2 Jurong Industrial Estate Singapore 638644	Tel. +65 68621701 Fax +65 68612827 http://www.sew-eurodrive.com.sg sewsingapore@sew-eurodrive.com
Slovakia			
Sales	Bratislava	SEW-Eurodrive SK s.r.o. Rybničná 40 SK-831 06 Bratislava	Tel. +421 2 33595 202 Fax +421 2 33595 200 sew@sew-eurodrive.sk http://www.sew-eurodrive.sk
	Žilina	SEW-Eurodrive SK s.r.o. Industry Park - PChZ ulica M.R.Štefánika 71 SK-010 01 Žilina	Tel. +421 41 700 2513 Fax +421 41 700 2514 sew@sew-eurodrive.sk
	Banská Bystrica	SEW-Eurodrive SK s.r.o. Rudlovska cesta 85 SK-974 11 Banská Bystrica	Tel. +421 48 414 6564 Fax +421 48 414 6566 sew@sew-eurodrive.sk
	Košice	SEW-Eurodrive SK s.r.o. Slovenská ulica 26 SK-040 01 Košice	Tel. +421 55 671 2245 Fax +421 55 671 2254 sew@sew-eurodrive.sk
Slovenia			
Sales	Celje	Pakman - Pogonska Tehnika d.o.o. Ul. XIV. divizije 14 SLO - 3000 Celje	Tel. +386 3 490 83-20 Fax +386 3 490 83-21 pakman@siol.net
Service			
South Africa			
Assembly	Johannesburg	SEW-EURODRIVE (PROPRIETARY) LIMITED Eurodrive House Cnr. Adcock Ingram and Aerodrome Roads Aeroton Ext. 2 Johannesburg 2013 P.O.Box 90004 Bertsham 2013	Tel. +27 11 248-7000 Fax +27 11 494-3104 http://www.sew.co.za info@sew.co.za
Sales			
Service			



Address List

South Africa			
	Cape Town	SEW-EURODRIVE (PROPRIETARY) LIMITED Rainbow Park Cnr. Racecourse & Omuramba Road Montague Gardens Cape Town P.O.Box 36556 Chempet 7442 Cape Town	Tel. +27 21 552-9820 Fax +27 21 552-9830 Telex 576 062 cfooster@sew.co.za
	Durban	SEW-EURODRIVE (PROPRIETARY) LIMITED 2 Monaco Place Pinetown Durban P.O. Box 10433, Ashwood 3605	Tel. +27 31 700-3451 Fax +27 31 700-3847 cdejager@sew.co.za
Spain			
Assembly Sales Service	Bilbao	SEW-EURODRIVE ESPAÑA, S.L. Parque Tecnológico, Edificio, 302 E-48170 Zamudio (Vizcaya)	Tel. +34 94 43184-70 Fax +34 94 43184-71 http://www.sew-eurodrive.es sew.spain@sew-eurodrive.es
Sweden			
Assembly Sales Service	Jönköping	SEW-EURODRIVE AB Gnejsvägen 6-8 S-55303 Jönköping Box 3100 S-55003 Jönköping	Tel. +46 36 3442 00 Fax +46 36 3442 80 http://www.sew-eurodrive.se jonkoping@sew.se
Switzerland			
Assembly Sales Service	Basel	Alfred Imhof A.G. Jurastrasse 10 CH-4142 Münchenstein bei Basel	Tel. +41 61 417 1717 Fax +41 61 417 1700 http://www.imhof-sew.ch info@imhof-sew.ch
Thailand			
Assembly Sales Service	Chonburi	SEW-EURODRIVE (Thailand) Ltd. 700/456, Moo.7, Donhuaroh Muang Chonburi 20000	Tel. +66 38 454281 Fax +66 38 454288 sewthailand@sew-eurodrive.com
Tunisia			
Sales	Tunis	T. M.S. Technic Marketing Service Zone Industrielle Mghira 2 Lot No. 39 2082 Fouchana	Tel. +216 71 4340-64 + 71 4320-29 Fax +216 71 4329-76 tms@tms.com.tn
Turkey			
Assembly Sales Service	Istanbul	SEW-EURODRIVE Hareket Sistemleri San. ve Tic. Ltd. Sti. Bagdat Cad. Koruma Cikmazi No. 3 TR-34846 Maltepe ISTANBUL	Tel. +90 216 4419163 / 4419164 Fax +90 216 3055867 http://www.sew-eurodrive.com.tr sew@sew-eurodrive.com.tr
Ukraine			
Sales Service	Dnepropetrovsk	SEW-EURODRIVE Str. Rabochaja 23-B, Office 409 49008 Dnepropetrovsk	Tel. +380 56 370 3211 Fax +380 56 372 2078 http://www.sew-eurodrive.ua sew@sew-eurodrive.ua



USA			
Production Assembly Sales Service Corporate Offices	Southeast Region	SEW-EURODRIVE INC. 1295 Old Spartanburg Highway P.O. Box 518 Lyman, S.C. 29365	Tel. +1 864 439-7537 Fax Sales +1 864 439-7830 Fax Manufacturing +1 864 439-9948 Fax Assembly +1 864 439-0566 Fax Confidential/HR +1 864 949-5557 http://www.seweurodrive.com cslyman@seweurodrive.com
Assembly Sales Service	Northeast Region	SEW-EURODRIVE INC. Pureland Ind. Complex 2107 High Hill Road, P.O. Box 481 Bridgeport, New Jersey 08014	Tel. +1 856 467-2277 Fax +1 856 845-3179 csbridgeport@seweurodrive.com
	Midwest Region	SEW-EURODRIVE INC. 2001 West Main Street Troy, Ohio 45373	Tel. +1 937 335-0036 Fax +1 937 440-3799 cstroy@seweurodrive.com
	Southwest Region	SEW-EURODRIVE INC. 3950 Platinum Way Dallas, Texas 75237	Tel. +1 214 330-4824 Fax +1 214 330-4724 csdallas@seweurodrive.com
	Western Region	SEW-EURODRIVE INC. 30599 San Antonio St. Hayward, CA 94544	Tel. +1 510 487-3560 Fax +1 510 487-6433 cshayward@seweurodrive.com
Additional addresses for service in the USA provided on request!			
Venezuela			
Assembly Sales Service	Valencia	SEW-EURODRIVE Venezuela S.A. Av. Norte Sur No. 3, Galpon 84-319 Zona Industrial Municipal Norte Valencia, Estado Carabobo	Tel. +58 241 832-9804 Fax +58 241 838-6275 http://www.sew-eurodrive.com.ve ventas@sew-eurodrive.com.ve sewfinanzas@cantv.net



SEW-EURODRIVE
Driving the world

SEW
EURODRIVE

SEW-EURODRIVE GmbH & Co KG
P.O. Box 3023
D-76642 Bruchsal/Germany
Phone +49 7251 75-0
Fax +49 7251 75-1970
sew@sew-eurodrive.com

→ www.sew-eurodrive.com