

**Fieldbus Interface DFP21B  
PROFIBUS DP-V1**

FA375100

Edition 07/2006

11479019 / EN

**Manual**

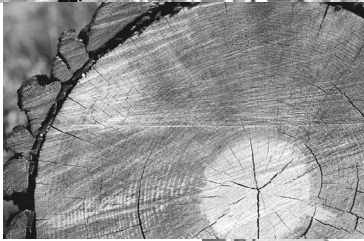
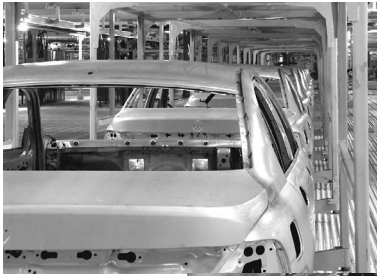



<b>1</b>	<b>Important Notes</b> .....	<b>6</b>
1.1	Explanation of symbols .....	6
1.2	Part of the product .....	6
1.3	Documentation reference.....	6
1.4	Liability for defects .....	7
1.5	Product names and trademarks.....	7
1.6	Disposal .....	7
<b>2</b>	<b>Safety Notes</b> .....	<b>8</b>
2.1	Preliminary information .....	8
2.2	General safety notes.....	8
2.2.1	General safety notes for bus systems.....	8
2.3	Transport / storage.....	8
2.4	Installation / assembly.....	9
2.5	Startup / operation .....	9
<b>3</b>	<b>Introduction</b> .....	<b>10</b>
3.1	Content of the manual.....	10
3.2	Additional documentation.....	10
3.3	Features.....	10
3.3.1	MOVIDRIVE <sup>®</sup> , MOVITRAC <sup>®</sup> B and PROFIBUS.....	10
3.3.2	Access to all information .....	11
3.3.3	Cyclical and acyclical data exchange via PROFIBUS DP .....	11
3.3.4	Acyclical data exchange via PROFIBUSDP-V1 .....	11
3.3.5	Configuring the PROFIBUS option card .....	12
3.3.6	Monitoring functions.....	12
3.3.7	Diagnostics .....	13
3.3.8	Fieldbus monitor .....	13
<b>4</b>	<b>Assembly and Installation Notes</b> .....	<b>14</b>
4.1	Installing the DFP21B option card in MOVIDRIVE <sup>®</sup> MDX61B .....	14
4.1.1	Before you start .....	14
4.1.2	Installing and removing an option card .....	15
4.2	Installing the DFP21B option card in MOVITRAC <sup>®</sup> B .....	16
4.2.1	SBus connection .....	16
4.2.2	System bus connection.....	17
4.3	Assembling and installing the UOH11B gateway housing .....	18
4.4	Connection and terminal description of the DFP21B option .....	20
4.5	Pin assignment .....	21
4.5.1	MOVIDRIVE <sup>®</sup> / MOVITRAC <sup>®</sup> B / PROFIBUS connection .....	21
4.5.2	Baud rates greater than 1.5 MBaud.....	21
4.6	Shielding and routing bus cables .....	22
4.7	Bus termination .....	22
4.8	Setting the station address .....	23
4.9	Operating mode displays: option DFP21B.....	24
4.9.1	PROFIBUS LEDs.....	24



<b>5</b>	<b>Project Planning and Startup</b>	<b>26</b>
5.1	Validity of the GSD files for DFP21B	26
5.2	DP master project planning the with MOVIDRIVE® GSD file	26
5.2.1	GSD file for PROFIBUSDP	26
5.2.2	GSD file for PROFIBUSDP-V1	27
5.2.3	Project planning procedure	28
5.2.4	DP configuration for MOVIDRIVE® MDX61B (SEWA6003.GSD)	29
5.2.5	MOVIDRIVE® MDX61B external diagnostics	32
5.3	DP master project planning with MOVITRAC® or gateway GSD file	34
5.3.1	GSD files for operation in MOVITRAC® B and UOH11B gateway housing	34
5.3.2	PROFIBUS DP master startup	35
5.3.3	Configuration of the PROFIBUSDP interface	36
5.3.4	Autosetup for gateway operation	40
5.4	Setting the MOVIDRIVE® MDX61B drive inverter	42
5.5	Setting the MOVITRAC® frequency inverter	43
<b>6</b>	<b>PROFIBUS DP Operating Characteristics</b>	<b>45</b>
6.1	Controlling the MOVIDRIVE® MDX61B drive inverter	45
6.1.1	Control example for SIMATIC S7 with MOVIDRIVE® MDX61B	46
6.1.2	PROFIBUS DP timeout (MOVIDRIVE® MDX61B)	46
6.1.3	Fieldbus timeout response (MOVIDRIVE® MDX61B)	46
6.2	Control of the MOVITRAC® inverter (gateway)	47
6.2.1	Control example for SIMATIC S7 with MOVITRAC® B (gateway)	48
6.2.2	SBus timeout	48
6.2.3	Unit faults	48
6.2.4	Fieldbus timeout of the DFP21B in gateway operation	49
6.3	Parameter settings via PROFIBUS DP	49
6.3.1	Structure of the 8-byte MOVILINK® parameter channel	49
6.3.2	Reading a parameter with PROFIBUS DP (READ)	52
6.3.3	Writing a parameter via PROFIBUS DP (WRITE)	53
6.3.4	Parameter setting procedure with PROFIBUS DP	54
6.3.5	Parameter data format	54
6.4	SIMATIC STEP7 program example	55
6.5	Return codes for parameter setting	56
6.5.1	Elements	56
6.5.2	Error class	56
6.5.3	Error code	56
6.5.4	Additional code	57
6.6	Special cases	57
6.6.1	Special return codes	57







<b>7 PROFIBUS DP-V1 Functions .....</b>	<b>59</b>
7.1 Introduction to PROFIBUS DP-V1 .....	59
7.1.1 Class 1 master (C1 master) .....	60
7.1.2 Class 2 master (C2 master) .....	60
7.1.3 Data sets (DS) .....	60
7.1.4 DP-V1 services .....	61
7.1.5 DP-V1 alarm handling.....	61
7.2 Features of SEW drive inverters .....	62
7.3 Structure of the DP-V1 parameter channel .....	63
7.3.1 Parameter setting procedure via data set 47 .....	65
7.3.2 DP-V1 master processing sequence .....	66
7.3.3 Addressing connected drive inverters.....	67
7.3.4 MOVILINK® parameter requests .....	67
7.3.5 PROFIdrive parameter requests.....	72
7.4 Project planning for a C1 master.....	77
7.4.1 Operating mode (DP-V1 mode) .....	77
7.4.2 Example program for SIMATIC S7 .....	78
7.4.3 DP-V1 technical data for MOVIDRIVE® DFP21 .....	83
7.4.4 Technical data DP-V1 for the gateway operation and MOVITRAC® ..	83
7.4.5 Error codes of the DP-V1 services.....	84
<b>8 Operation of MOVITOOLS® MotionStudio via PROFIBUS.....</b>	<b>85</b>
8.1 Introduction .....	85
8.2 Required hardware .....	86
8.3 Required software .....	86
8.4 Installation .....	86
8.5 Configuring SIMATIC NET .....	87
8.6 Configuration of SEW communication server .....	90
8.6.1 Establishing communication .....	90
8.6.2 Procedure .....	90
8.7 Automatic search for connected units (unit scan) .....	93
8.8 Activating online operation .....	93
8.9 Known problems when operating MOVITOOLS® MotionStudio .....	94
<b>9 Error Diagnostics .....</b>	<b>95</b>
9.1 Diagnostic procedures .....	95
9.2 List of errors .....	98
<b>10 Technical Data.....</b>	<b>99</b>
10.1 Option DFP21B for MOVIDRIVE® MDX61B .....	99
10.2 DFP21B option for MOVITRAC® B and UOH11B gateway housing.....	100
<b>11 Index.....</b>	<b>101</b>



## 1 Important Notes

### 1.1 Explanation of symbols

Always follow the safety and warning notes in this publication.

	<p><b>Electrical hazard</b> Possible consequences: Severe or fatal injuries</p>
	<p><b>Hazard</b> Possible consequences: Severe or fatal injuries</p>
	<p><b>Hazardous situation</b> Possible consequences: Slight or minor injuries</p>
	<p><b>Harmful situation</b> Possible consequences: Damage to the unit and the environment</p>
	<p>Tips and useful information</p>

### 1.2 Part of the product

The manual is a component of the DFP21B PROFIBUSDP-V1 fieldbus interface and contains important information for operation and service.

### 1.3 Documentation reference

- You must adhere to the information in the documentation to ensure:
  - Fault-free operation
  - Fulfillment of any rights to claim under limited warranty
- Consequently, read through this manual carefully before you start installation and startup of the frequency inverters with the DFP21B PROFIBUS option card.
- This manual assumes that the user has access to and is familiar with the MOVIDRIVE® and MOVITRAC® documentation, in particular the MOVIDRIVE® MDX60B/61B und MOVITRAC® B system manuals.



#### **1.4 Liability for defects**

Incorrect handling or undertaking any action that is not specified in this manual could impair the properties of the product. If this is the case, you lose any right to claim against SEW-EURODRIVE GmbH & Co KG under limited warranty.

#### **1.5 Product names and trademarks**

The brands and product names named in these operating instructions are trademarks or registered trademarks of the titleholders.

#### **1.6 Disposal**



**Please follow the current national regulations.**

Dispose of the following materials separately in accordance with the country-specific regulations in force, as:

- Electronic scrap
- Plastics
- Sheet metal
- Copper

and so on



## 2 Safety Notes



- You are only allowed to perform installation and startup of the DFP21B fieldbus interface when observing applicable accident prevention regulations and the MOVIDRIVE® MDX60B/61B and MOVITRAC® B operating instructions.

### 2.1 Preliminary information



The following safety notes apply to the fieldbus interface DFP21B PROFIBUS DP-V1.

Please also consider the supplementary safety notes in the individual sections of this manual.

### 2.2 General safety notes



**Never install or start up damaged products.**

Submit a complaint to the shipping company immediately in the event of damage.

#### 2.2.1 General safety notes for bus systems



This communication system allows you to adjust the MOVIDRIVE® drive inverter to your specific application very accurately. **As with all bus systems, there is a danger of modifications to the parameters that are not visible from outside (in relation to the inverter), which give rise to changes in the inverter behavior. This may result in unexpected (not uncontrolled) system behavior.**

### 2.3 Transport / storage

**Inspect the shipment as soon as you receive the delivery and inform the shipping company of any damage that may have occurred in transit immediately. Do not operate the product if it is damaged.**

Use suitable, sufficiently rated handling equipment if necessary.



**Damage can result from incorrect storage.**

Store the unit in a dry, dust-free room if it is not to be installed straight away.





---

**2.4 Installation / assembly**

Adhere to the instructions in section 4, "Assembly and Installation Notes".

**2.5 Startup / operation**

Adhere to the instructions in section 5, "Project Planning and Startup".



## **3 Introduction**

### **3.1 Content of the manual**

This user manual describes how to:

- Install the PROFIBUS DFP21B option card in the MOVIDRIVE<sup>®</sup> MDX61B drive inverter
- Use the PROFIBUS DFP21B option card in the MOVIDRIVE<sup>®</sup> B frequency inverter and in the UOH11B gateway housing
- Start up the MOVIDRIVE<sup>®</sup> B with the PROFIBUS fieldbus system
- Start up the MOVITRAC<sup>®</sup> B with the PROFIBUS gateway
- Configure the PROFIBUS using GSD files
- Operate MOVITOOLS<sup>®</sup> MotionStudio via PROFIBUS

### **3.2 Additional documentation**

For information on how to connect MOVIDRIVE<sup>®</sup> straightforwardly and effectively to the PROFIBUS fieldbus system, in addition to this user manual about the PROFIBUS option, you should request the following publications about fieldbus technology:

- MOVIDRIVE<sup>®</sup> Fieldbus Unit Profile manual
- MOVITRAC<sup>®</sup> B system manual

The manual for the MOVIDRIVE<sup>®</sup> Fieldbus Unit Profile and MOVITRAC<sup>®</sup> B system manual describes the fieldbus parameters and their coding, and explains the whole range of various control concepts and application options in the form of brief examples.

The MOVIDRIVE<sup>®</sup> "Fieldbus Unit Profile" manual contains a listing of all parameters of the drive inverter which can be read and written via the various communication interfaces, such as system bus, RS-485 and also via the fieldbus interface.

### **3.3 Features**

The MOVIDRIVE<sup>®</sup> MDX61B drive inverter and MOVITRAC<sup>®</sup> B frequency inverter allow you to use the DFP21B option to connect to higher-level automation systems via PROFIBUS thanks to its powerful universal fieldbus interface.

#### **3.3.1 MOVIDRIVE<sup>®</sup>, MOVITRAC<sup>®</sup> B and PROFIBUS**

The unit behavior of the inverter, which forms the basis of PROFIBUS operation, is referred to as the unit profile. It is independent of any particular fieldbus and is therefore a uniform feature. This feature allows the user to develop fieldbus-independent drive applications. This makes it much easier to change to other bus systems, such as DeviceNet (option DFD).



### 3.3.2 Access to all information

MOVIDRIVE<sup>®</sup> MDX61B offers digital access to all drive parameters and functions via the PROFIBUS interface. The drive inverter is controlled via fast, cyclic process data. Via this process data channel, you can enter setpoints such as the setpoint speed, ramp generator time for acceleration/deceleration, etc. as well as trigger various drive functions such as enable, control inhibit, normal stop, rapid stop, etc. However, at the same time you can also use this channel to read back actual values from the drive inverter, such as the actual speed, current, unit status, fault number and reference signals.

### 3.3.3 Cyclical and acyclical data exchange via PROFIBUS DP

While process data exchange usually takes place cyclically, drive parameters can be read and written acyclically via functions such as READ or WRITE or via the MOVILINK<sup>®</sup> parameter channel. This parameter data exchange enables you to implement applications in which all the important drive parameters are stored in the master programmable controller, so that there is no need to make parameter settings manually on the drive inverter itself.

### 3.3.4 Acyclical data exchange via PROFIBUS DP-V1

The PROFIBUS DP-V1 specification introduced new acyclical READ/WRITE services as part of the PROFIBUSDP expansions. These acyclical services are added to the current cyclical bus operation in special telegrams to ensure compatibility of PROFIBUS DP and PROFIBUS DP V1.



### 3.3.5 Configuring the PROFIBUS option card

Generally, the PROFIBUS option card has been designed so that all fieldbus-specific settings, such as the station address and the default bus parameter can be made using hardware switches on the option card. This manual setting means the drive inverter can be integrated into the PROFIBUS environment and switched on within a very short period of time.

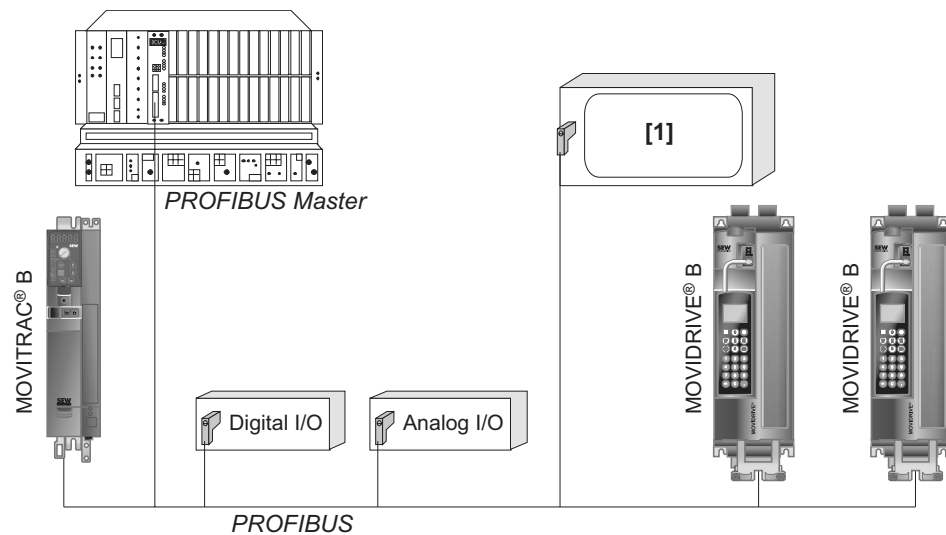

Figure 1: PROFIBUS with MOVIDRIVE®

58687AXX

[1] Visualization

### 3.3.6 Monitoring functions

Using a fieldbus system demands additional monitoring functions in the drive engineering, for example, time monitoring of the fieldbus (fieldbus timeout) or rapid stop concepts. For example, you can adapt MOVIDRIVE®/MOVITRAC® monitoring functions specifically to your application. You can determine, for instance, which of the drive inverter's fault responses should be triggered in the event of a bus error. A rapid stop is a good idea for many applications, although this can also be achieved by "freezing" the last setpoints so the drive continues operating with the most recently valid setpoints (such as with a conveyor belt). As the control terminals also function in fieldbus operation, you can still implement fieldbus-independent emergency stop concepts via the terminals of the drive inverter.



### 3.3.7 Diagnostics

The MOVIDRIVE® drive inverter and the MOVITRAC® B frequency inverter offer you numerous diagnostics options for startup and service. For example, you can use the integrated fieldbus monitor to control setpoint values sent from the higher-level control as well as the actual values.

### 3.3.8 Fieldbus monitor

Furthermore, you are supplied with a variety of additional information about the status of the fieldbus option card. The fieldbus monitor function in conjunction with the MOVITOOLS® MotionStudio PC software offers you an easy-to-use diagnostic tool for setting all drive parameters (including the fieldbus parameters) and for displaying the fieldbus and device status information in detail.



## 4 Assembly and Installation Notes

This section contains information about assembly and installation of the DFP21B option card in the MOVIDRIVE® MDX61B, MOVITRAC® B and UOH11B gateway housing.

### 4.1 Installing the DFP21B option card in MOVIDRIVE® MDX61B



Only SEW-EURODRIVE engineers are allowed to install or remove option cards for MOVIDRIVE® MDX61B size 0.

- Option cards can only be installed or removed by users for MOVIDRIVE® MDX61B sizes 1 to 6.

#### 4.1.1 Before you start

The DFP21B option card must be plugged into the fieldbus slot.

**Observe the following notes before installing or removing an option card:**

- Disconnect the inverter from the power. Switch off the DC 24 V and the supply voltage.
- Take appropriate measures to protect the option card from electrostatic charge (use discharge strap, conductive shoes, and so on) before touching it.
- **Before installing** the option card, remove the keypad and the front cover.
- **After installing** the option card, replace the keypad and the front cover.
- Keep the option card in its original packaging until immediately before you are ready to install it.
- Hold the option card by its edges only. Do not touch any components.



#### 4.1.2 Installing and removing an option card

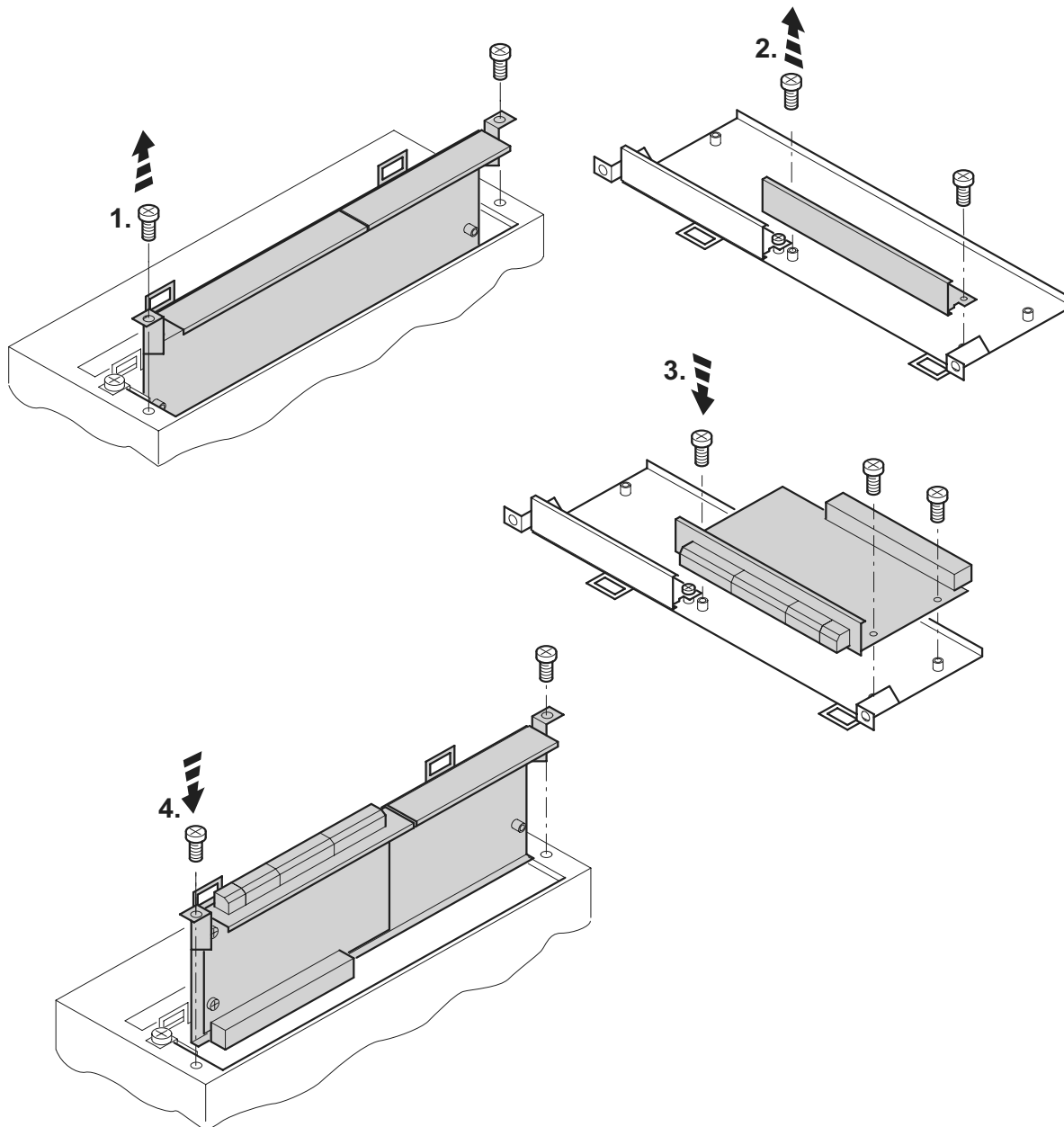

Figure 2: Installing an option card in MOVIDRIVE® MDX61B sizes 1 to 6

53001AXX

1. Remove the two retaining screws holding the card retaining bracket. Pull the card retaining bracket out evenly from the slot (do not twist!).
2. Remove the two retaining screws of the black cover plate on the card retaining bracket. Remove the black cover plate.
3. Position the option card onto the retaining bracket so that the three retaining screws fit into the corresponding bores on the card retaining bracket.
4. Insert the retaining bracket with installed option card into the slot, pressing slightly so it is seated properly. Secure the card retaining bracket with the two retaining screws.
5. To remove the option card, follow the instructions in reverse order.



## Assembly and Installation Notes

### Installing the DFP21B option card in MOVITRAC® B

#### 4.2 Installing the DFP21B option card in MOVITRAC® B



- MOVITRAC® B does not require special firmware status.
- Only SEW-EURODRIVE engineers are allowed to install or remove option cards for MOVITRAC® B.

##### 4.2.1 SBus connection

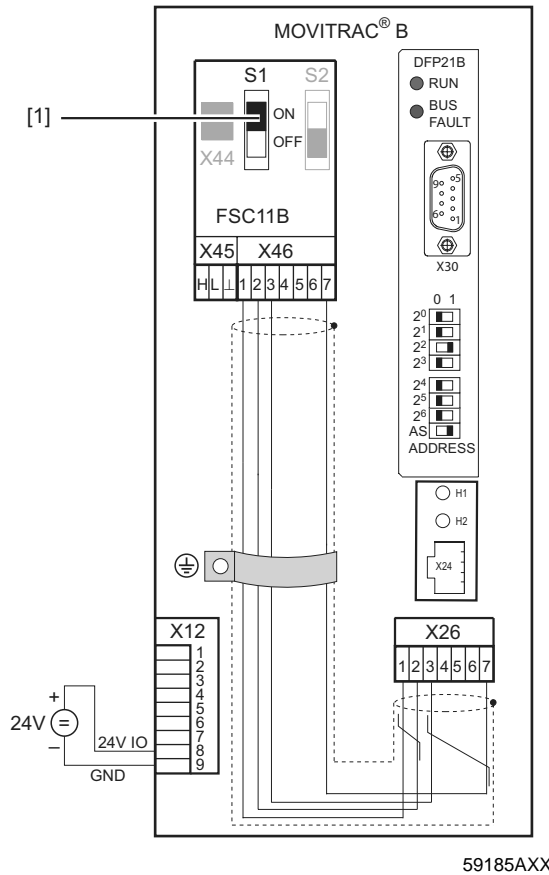

[1] Terminating resistor activated, S1 = ON



The DFP21B features an integrated SBus terminating resistor and must therefore always be installed at the beginning of the SBus connection.

The address of the DFP21B is always 0.

X46	X26	
X46:1	X26:1	SC11 SBus +, CAN high
X46:2	X26:2	SC12 SBus -, CAN low
X46:3	X26:3	GND, CAN GND
X46:7	X26:7	DC 24 V
X12		
X12:8		+24-V input
X12:9		GND reference potential for the binary inputs





To simplify cabling, the DFP21B can be supplied with DC 24V from X46.7 of the MOVITRAC® to X26.7.

MOVITRAC® must be supplied with DC 24V at terminals X12.8 and X12.9 when supplying the DFP21B by MOVITRAC®.

**4.2.2 System bus connection**

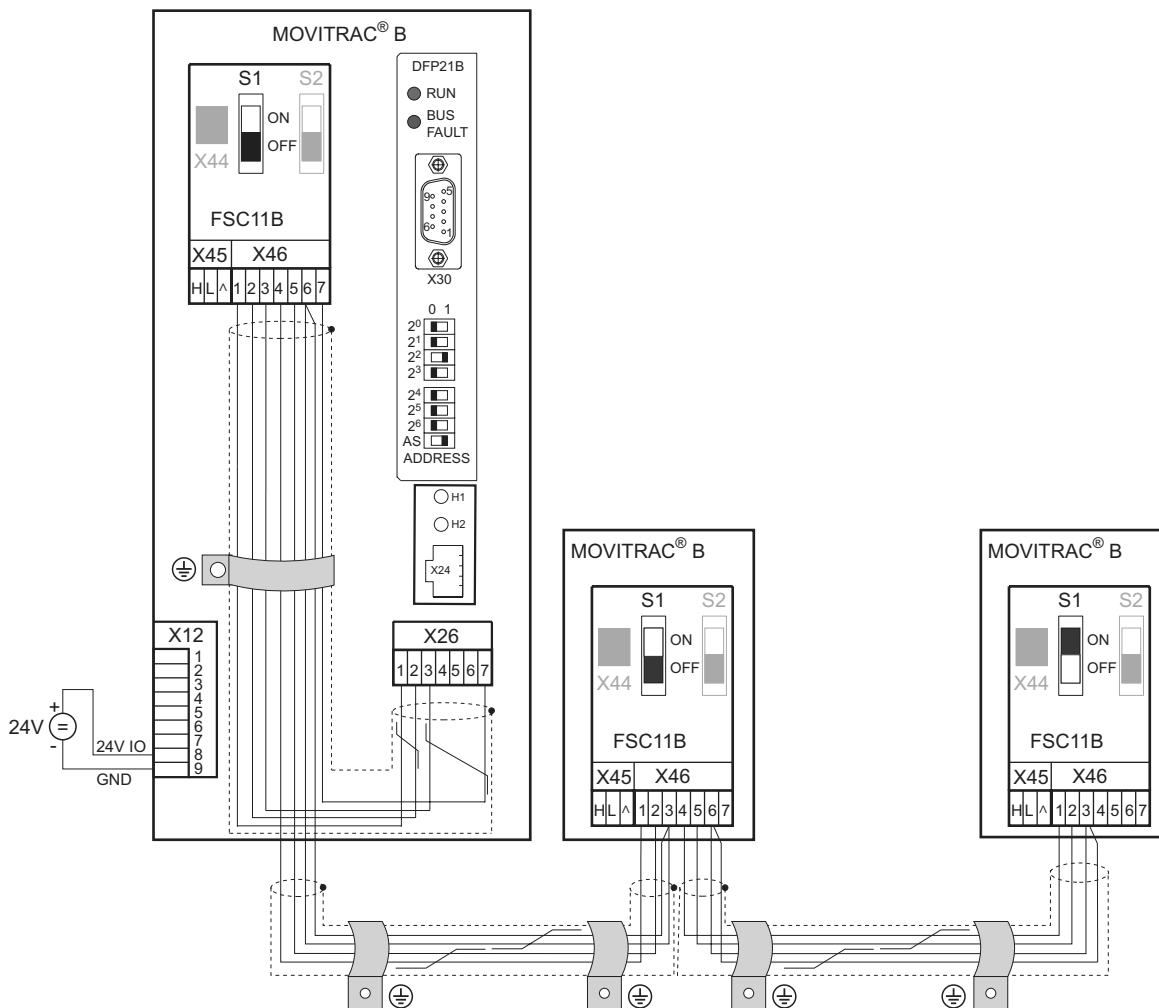

59186AXX

Figure 3: System bus connection

**DFP**  
 GND = System bus reference  
 SC11 = System bus high  
 SC12 = System bus low

**MOVITRAC® B**  
 GND = System bus reference  
 SC22 = System bus low, outgoing  
 SC21 = System bus high, outgoing  
 SC12 = System bus low, incoming  
 SC11 = System bus high, incoming  
 S12 = System bus terminating resistor



## Assembly and Installation Notes

### Installing the DFP21B option card in MOVITRAC® B

---

Note:

- Use a two-core twisted and shielded copper cable (data transmission cable with braided copper shield). Connect the shield flatly on both sides of the electronics shield clamp of MOVITRAC®. Also connect the ends of the shield to GND. The cable must meet the following specifications:
    - Core cross-section 0.75 mm<sup>2</sup> (AWG18)
    - Line resistance 120 Ω at 1 MHz
    - Capacitance per unit length ≤ 40 pF/m (12 pF/ft) at 1 kHz
  - The permitted total cable length depends on the baud rate setting of the SBus:
    - 250 kbaud: 160 m (528 ft)
    - 500 kbaud: 80 m (264 ft)
    - 1000 kbaud: 40 m (132 ft)
  - Connect the system bus terminating resistor (S1 = ON) at the end of the system bus connection. Switch off the terminating resistor on the other units (S1 = OFF). The DFP21B gateway must always be connected either at the beginning or the end of the system bus connection and features a permanently installed terminating resistor.
- 
- 
- There must not be any potential displacement between the units connected with the SBus. Take suitable measures to avoid potential displacement, such as connecting the unit ground connectors using a separate cable.
  - Point-to-point wiring is not permitted.



**4.3 Assembling and installing the UOH11B gateway housing**

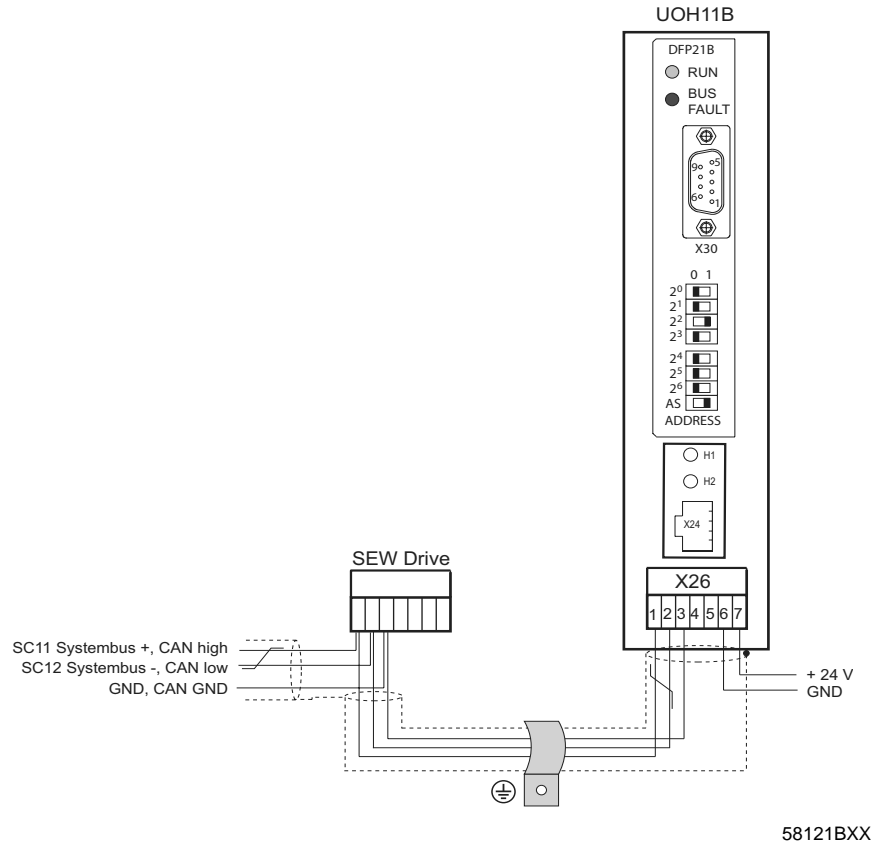

<b>X26</b>	
X26:1	SC11 system bus +, CAN high
X26:2	SC12 system bus, CAN low
X26:3	GND, CAN GND
X26:6	GND, CAN GND
X26:7	DC 24 V

The gateway housing has a power supply of DC 24V that is connected to X26.



## Assembly and Installation Notes

### Connection and terminal description of the DFP21B option

#### 4.4 Connection and terminal description of the DFP21B option

**Part number** PROFIBUS interface type DFP21B option: 824 240 2



The "PROFIBUS interface type DFP21B" option is only possible in conjunction with MOVIDRIVE® MDX61B, not with MDX60B.

The DFP21B option must be plugged into the fieldbus slot.

Front view of DFP21B	Description	DIP switches Terminal	Function
<p>DFP21B</p> <ul style="list-style-type: none"> <li>● RUN</li> <li>● BUS FAULT</li> </ul> <p>9° 5°</p> <p>6° 01</p> <p>X30</p> <p>0 1</p> <p>2<sup>0</sup> 2<sup>1</sup> 2<sup>2</sup> 2<sup>3</sup> 2<sup>4</sup> 2<sup>5</sup> 2<sup>6</sup> AS</p> <p>ADDRESS</p> <p>59110AXX</p>	<p><b>RUN: PROFIBUS operation LED (green)</b></p> <p><b>BUS FAULT: PROFIBUS error LED (red)</b></p>		<p>Indicates that the bus electronics are operating correctly.</p> <p>Indicates PROFIBUSDP error.</p>
	<p><b>ADDRESS: DIP switch for setting the PROFIBUS station address</b></p>	<p>2<sup>0</sup></p> <p>2<sup>1</sup></p> <p>2<sup>2</sup></p> <p>2<sup>3</sup></p> <p>2<sup>4</sup></p> <p>2<sup>5</sup></p> <p>2<sup>6</sup></p> <p>AS</p>	<p>Significance: 1</p> <p>Significance: 2</p> <p>Significance: 4</p> <p>Significance: 8</p> <p>Significance: 16</p> <p>Significance: 32</p> <p>Significance: 64</p> <p>Autosetup for gateway operation</p>
	<p><b>X30: PROFIBUS connection</b></p>	<p>X30:1</p> <p>X30:2</p> <p>X30:3</p> <p>X30:4</p> <p>X30:5</p> <p>X30:6</p> <p>X30:7</p> <p>X30:8</p> <p>X30:9</p>	<p>N.C.</p> <p>N.C.</p> <p>RxD/TxD-P</p> <p>CNTR-P</p> <p>DGND (M5V)</p> <p>VP (P5V/100 mA)</p> <p>N.C.</p> <p>RxD/TxD-N</p> <p>DGND (M5V)</p>

Front view of MOVITRAC® B, DFP21B and UOH11B	Description		Function
<p>H1</p> <p>H2</p> <p>X24</p> <p>58129axx</p>	<p><b>LED H1 (red)</b></p> <p><b>LED H2 (green)</b></p> <p><b>X24 X terminal</b></p>		<p>System error (only for gateway functions)</p> <p>Reserved</p> <p>RS-485 interface for diagnostics via PC and MOVITOOLS® MotionStudio (only applies to MOVITRAC® B)</p>



## 4.5 Pin assignment

Connection to the PROFIBUS network using a 9-pin sub D plug according to IEC 61158. The T-bus connection must be made using a connector with the corresponding configuration.

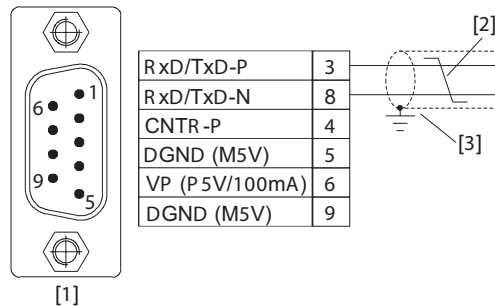

Figure 4: Assignment of 9-pin sub D plug to IEC 61158

06227AXX

- [1] 9-pin sub-D connector
- [2] Signal line, twisted
- [3] Conductive, wide area connection is necessary between the connector housing and the shield

### 4.5.1 MOVIDRIVE® / MOVITRAC® B / PROFIBUS connection

As a rule, the DFP21B option is connected to the PROFIBUS system using a shielded twisted-pair cable. Observe the maximum supported transmission rate when selecting the bus connector.

The twisted-pair cable is connected to the PROFIBUS connector at pin 3 (RxD/TxD-P) and pin 8 (RxD/TxD-N). Communication takes place via these two contacts. The RS-485 signals RxD/TxD-P and RxD/TxD-N must be connected to the same contacts in all PROFIBUS stations. Otherwise, no communication is possible via the bus medium.

The PROFIBUS interface sends a TTL control signal for a repeater or fiber optic adapter (reference = pin 9) via pin 4 (CNTR-P).

### 4.5.2 Baud rates greater than 1.5 Mbaud

The DFP21B option with baud rates > 1.5 Mbaud can only be operated with special 12-Mbaud PROFIBUS connectors.



#### 4.6 Shielding and routing bus cables

The PROFIBUS interface supports RS-485 transmission technology and requires the cable type A to IEC 61158 as the physical medium for the PROFIBUS. This cable must be a shielded, twisted-pair cable.

Correct shielding of the bus cable attenuates electrical interference that may occur in industrial environments. The following measures ensure the best possible shielding:

- Manually tighten the mounting screws on the connectors, modules, and equipotential bonding conductors.
- Use only connectors with a metal housing or a metallized housing.
- Connect the shielding in the connector over a wide surface area.
- Apply the shielding of the bus line on both ends.
- Route signal and bus cables in separate cable ducts. Do not route them parallel to power cables (motor leads).
- In industrial environments, use metallic, grounded cable racks.
- Route the signal cable and the corresponding equipotential bonding close to each other using the shortest possible route.
- Avoid using plug connectors to extend bus cables.
- Route the bus cables closely along existing grounding surfaces.



In case of fluctuations in the ground potential, a compensating current may flow via the bilaterally connected shield that is also connected to the protective earth (PE). In this case, make adequate provision for equipotential bonding in accordance with the relevant VDE regulations.

#### 4.7 Bus termination

The DFP21B option is not provided with bus terminating resistors. This enables the bus system to be put into operation more easily and reduces the number of error sources.

Use a plug with an integrated bus terminating resistor if the DFP21B option is at the beginning or end of a PROFIBUS segment and only one PROFIBUS cable is leading to the DFP21B.

Switch on the bus terminating resistors for this PROFIBUS connector.



### 4.8 Setting the station address

The PROFIBUS station address is set using DIP switches 2<sup>0</sup> to 2<sup>6</sup> on the option card. MOVIDRIVE® supports the address range 1 to 125.

The default setting for the PROFIBUS station address is 4:

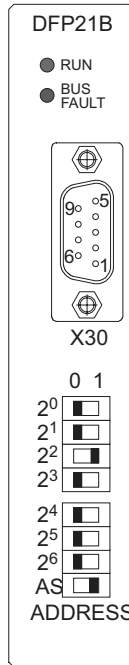

59110AXX

- 2<sup>0</sup> → Significance: 1 × 0 = 0
- 2<sup>1</sup> → Significance: 2 × 0 = 0
- 2<sup>2</sup> → Significance: 4 × 1 = 4
- 2<sup>3</sup> → Significance: 8 × 0 = 0
- 2<sup>4</sup> → Significance: 16 × 0 = 0
- 2<sup>5</sup> → Significance: 32 × 0 = 0
- 2<sup>6</sup> → Significance: 64 × 0 = 0

Any change made to the PROFIBUS station address during ongoing operation does not take effect immediately. The change only comes into effect when the inverter is switched on again (power supply + 24 V OFF/ON). The inverter displays the current station address in fieldbus monitor parameter P092 "Fieldbus address" (display with DBG60B or MOVITOOLS®/SHELL).

**Example: Setting the PROFIBUS station address 17**

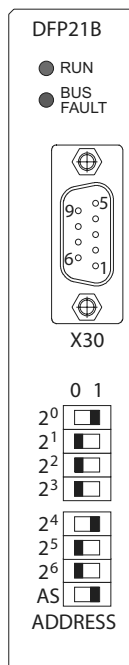

59111AXX

- 2<sup>0</sup> → Significance: 1 × 1 = 1
- 2<sup>1</sup> → Significance: 2 × 0 = 0
- 2<sup>2</sup> → Significance: 4 × 0 = 0
- 2<sup>3</sup> → Significance: 8 × 0 = 0
- 2<sup>4</sup> → Significance: 16 × 1 = 16
- 2<sup>5</sup> → Significance: 32 × 0 = 0
- 2<sup>6</sup> → Significance: 64 × 0 = 0



#### 4.9 Operating mode displays: option DFP21B

##### 4.9.1 PROFIBUS LEDs

The PROFIBUS interface DFP21B option card has 2 LEDs that indicate the current status of the DFP21B option and the PROFIBUS system.

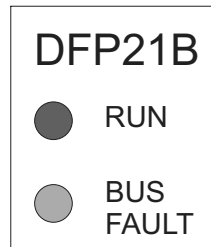

58361AXX

**RUN LED (green)** • The **RUN** LED (green) indicates that the bus electronics are operating correctly

RUN	Cause of error	Remedy
Green	<ul style="list-style-type: none"> <li>PROFIBUS hardware OK.</li> </ul>	–
Orange	<ul style="list-style-type: none"> <li>The card is booting.</li> </ul>	–
Off	<ul style="list-style-type: none"> <li>Hardware defect in the bus electronics.</li> </ul>	<ul style="list-style-type: none"> <li>Switch the unit on again. Consult SEW service if the error occurs again.</li> </ul>
Flashes 2Hz	<ul style="list-style-type: none"> <li>PROFIBUS address is set higher than 125 or to 0.</li> </ul>	<ul style="list-style-type: none"> <li>Use parameter <i>P093 Fieldbus Address</i> to check the address set with the DIP switches.</li> <li>Reset the inverter.</li> </ul>
Flashes 1Hz	<ul style="list-style-type: none"> <li>No error, only display.</li> </ul>	<ul style="list-style-type: none"> <li>The inverter is restarting.</li> </ul>

**LED BUS FAULT (red)** • The **BUS FAULT** LED (red) indicates a PROFIBUSDP fault.

BUS FAULT	Cause of error	Remedy
Red	<ul style="list-style-type: none"> <li>Connection to the DP master has dropped.</li> <li>Unit does not detect a PROFIBUS baud rate.</li> <li>Possible bus interruption.</li> <li>DP master not in operation.</li> </ul>	<ul style="list-style-type: none"> <li>Check the PROFIBUSDP connection on the unit.</li> <li>Check the project planning of the DP master.</li> <li>Check all cables in your PROFIBUS DP network.</li> </ul>
Off	<ul style="list-style-type: none"> <li>Unit is currently exchanging data with the DP master (data exchange).</li> </ul>	–
Flashing	<ul style="list-style-type: none"> <li>Unit has detected the baud rate, but is not being addressed by the DP master.</li> <li>Unit was not configured in the DP master or was configured incorrectly.</li> </ul>	<ul style="list-style-type: none"> <li>Check the PROFIBUS address setting on the DFP21B and in the project planning software of the DP master.</li> <li>Check the project planning of the DP master.</li> <li>Use the GSD file <b>SEWA6003.GSD</b> with the identifier <b>MOVIDRIVE®-DFP21B</b> or <b>SEW_6009.GSD</b> for gateway operation with MOVITRAC® B for project planning.</li> </ul>





LEDs for gateway  
 communication  
 status

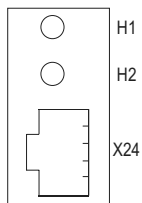

58129axx

LED H1 Sys-fault (red)	Only for gateway function	
Status	Status	Description
Red	System error	Gateway is not configured or one of the drives is inactive.
Off	SBus ok	Gateway is configured correctly
Flashing	Bus scan	Bus is being checked by the gateway



LED **H2** (green) is currently reserved.

X-terminal X24 is the RS-485 interface for diagnostics via PC and MOVITOOLS® MotionStudio.



## 5 Project Planning and Startup

This section provides you with information on project planning for the DP master and startup of the drive inverter for fieldbus operation.



Current versions of the GSD files for the DFP21B option are available on the SEW homepage (<http://www.sew-eurodrive.de>) under the heading "Software". Both GSD files can be used at the same time in one STEP7 project. Once you have downloaded and unpacked the software, you will have two directories for the operating modes PROFIBUS DP and PROFIBUS DP-V1.

### 5.1 Validity of the GSD files for DFP21B

PROFIBUS option DFP21B074 firmware option 1:	SEW_6003.GSD for DP	SEWA6003.GSD for DP-V1	SEW_6009.GSD for DP-V1 Gateway operation
824 399 9.10 and higher	ok	ok	No
1820 536 4.10 and higher	ok	ok	ok



Entries in the GSD file must not be changed or expanded. SEW assumes no liability for inverter malfunctions caused by a modified GSD file.

### 5.2 DP master project planning the with MOVIDRIVE® GSD file

A GSD file is provided for project planning for the DP master. This file must be copied into a special folder of your project planning software.

Refer to the manuals of the appropriate project planning software for details on the procedure.

#### 5.2.1 GSD file for PROFIBUSDP

Use the **GSD file SEW\_6003.GSD** from the "DP" directory if you want to use PROFIBUS DP communication to control the drive inverter. This GSD file corresponds to the GSD revision1 and must be copied to a special directory of your project planning software. Refer to the manuals of the appropriate project planning software for details on the procedure.

The unit master data files standardized by the PROFIBUS user group can be read by all PROFIBUS DP masters.

Project planning tool	DP master	File name
All DP project planning tools to EN 50170 (V2)	For DP master standard	SEW_6003.GSD
Siemens S7 hardware configuration	For all S7 DP masters	
Siemens S5 COM PROFIBUS	For IM 308C etc.	

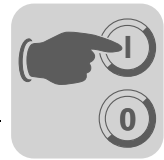

### 5.2.2 GSD file for PROFIBUS DP-V1

Use the **GSD file SEWA6003.GSD** from the "DP-V1" directory if you want to use the parameter setting options of DP-V1 in addition to the standard PROFIBUS DP communication to control the drive inverter.

This GSD file corresponds to GSD revision 3. If you use older, non-DP-V1-capable PROFIBUS options, a connection is not established between the DP-V1 master and DFP21B. In this case, the **BUS FAULT** LED of DFP21B remains switched on after the DP-V1 master has started. The DP V1 master will indicate that the connection cannot be established.

So that the GSD files are easy to identify, they are assigned the name for PROFIBUS-DP-V1 and displayed in a special subdirectory in the project planning software for the DP-V1 master (see following screenshot).

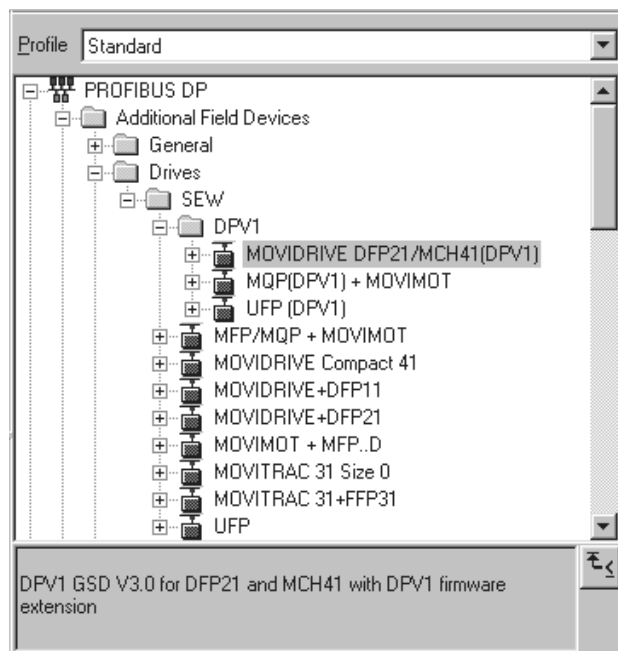

53545AXX



### 5.2.3 Project planning procedure

Proceed as follows for project planning for MOVIDRIVE® with PROFIBUS DP interface:

1. Read the *README\_GSDA6003.PDF* file, which you receive with the GSD file for further current information on project planning.
2. Install (copy) the GSD file according to the requirements of your project planning software. Once the file has been installed correctly, the device appears next to the slave stations with the designation *MOVIDRIVE®+DFP21*.
3. Add the interface module under the name *MOVIDRIVE®+DFP21* to the PROFIBUS structure and assign the station address.
4. Select the process data configuration required for your application (see section 5.2.4 on page 29).
5. Enter the I/O or peripheral addresses for the configured data widths.

After project planning, you can start PROFIBUS DP. The red **BUS FAULT** LED indicates the status of the project planning (OFF = project planning OK).



### 5.2.4 DP configuration for MOVIDRIVE® MDX61B (SEWA6003.GSD)

The drive inverter must be given a specific DP configuration by the DP master to define the type and number of input and output data used for transmission. You can

- Control the drive using process data
- Read and write all drive parameters using the parameter channel
- Use a data exchange medium of your choice between IPOS<sup>plus</sup> and the controller

MOVIDRIVE® drive inverters make it possible to have different DP configurations for exchanging data between the DP master and the inverter. The following table provides additional information about all possible DP configurations for the MOVIDRIVE® range. The "Process data configuration" column lists the names of the configurations. This text is also displayed as selection list within the project planning software for the DP master. The "DP configurations" column shows which configuration data is sent to the inverter when the PROFIBUS DP connection is being established.

Process data configuration	Meaning / notes	DP configuration	
		0	1
1 PD	MOVIDRIVE® control via 1 process data word	F0 <sub>hex</sub>	-
2 PD	MOVIDRIVE® control via 2 process data words	F1 <sub>hex</sub>	-
3 PD	MOVIDRIVE® control via 3 process data words	F2 <sub>hex</sub>	-
6 PD	MOVIDRIVE® control via 6 process data words (PD4-PD6 can only be used with IPOSplus®)	0 <sub>hex</sub>	F5 <sub>hex</sub>
10 PD	MOVIDRIVE® control via 10 process data words (PD4-PD10 can only be used with IPOSplus®)	0 <sub>hex</sub>	F9 <sub>hex</sub>
Param + 1 PD	MOVIDRIVE® control via 1 process data word Parameter setting via 8 byte parameter channel	F3 <sub>hex</sub>	F0 <sub>hex</sub>
Param + 2 PD	MOVIDRIVE® control via 2 process data words Parameter setting via 8 byte parameter channel	F3 <sub>hex</sub>	F1 <sub>hex</sub>
Param + 3 PD	MOVIDRIVE® control via 3 process data words Parameter setting via 8 byte parameter channel	F3 <sub>hex</sub>	F2 <sub>hex</sub>
Param + 6 PD	MOVIDRIVE® control via 6 process data words Parameter setting via 8 byte parameter channel (PD4-PD10 can only be used with IPOSplus®)	F3 <sub>hex</sub>	F5 <sub>hex</sub>
Param + 10 PD	MOVIDRIVE® control via 10 process data words Parameter setting via 8 byte parameter channel (PD4-PD10 can only be used with IPOSplus®)	F3 <sub>hex</sub>	F9 <sub>hex</sub>



#### **Universal DP configuration**

If you select the "Universal Module" DP configuration (S7 HWConfig), you can structure the DP configuration individually, although you must comply with the following conditions.

#### **Module 0 (DP identifier 0) defines the parameter channel of the inverter.**

To ensure the parameter settings are made correctly, you must always transfer the parameter channel consistently for the entire length.

Length	Function
0	Parameter channel deactivated
8 I/O bytes or 4 I/O words	Parameter channel is used

#### **Module 1 (DP identifier 1) defines the process data channel of the inverter.**

In addition to the process data configuration predefined in the GSD file, you can also specify the process data configuration with 4, 5, 7, 8 and 9 process data words. Ensure that the number of input and output words is always the same. If the lengths are different, data cannot be exchanged. In this case, the **BUS FAULT** LED flashes and the parameter *P090 PD Configuration* indicates the configuration error with **OPD**.

Length	Function
2 I/O bytes or 1 I/O word	1 process data word
4 I/O bytes or 2 I/O words	2 process data words
6 I/O bytes or 3 I/O words	3 process data words
8 I/O bytes or 4 I/O words	4 process data words
10 I/O bytes or 5 I/O words	5 process data words
12 I/O bytes or 6 I/O words	6 process data words
14 I/O bytes or 7 I/O words	7 process data words
16 I/O bytes or 8 I/O words	8 process data words
18 I/O bytes or 9 I/O words	9 process data words
20 I/O bytes or 10 I/O words	10 process data words

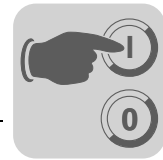

The following figure shows the structure of the configuration data defined in EN 50170 (V2). This configuration data is transmitted to the drive inverter during the initial start of the DP master.

7 / MSB	6	5	4	3	2	1	0 / LSB
				<b>Data length</b> 0000 = 1 byte/word 1111 = 16 bytes/words			
				<b>Input / output</b> 00 = Special identifier formats 01 = Input 10 = Output 11 = Input / output			
				<b>Format</b> 0 = Byte structure 1 = Word structure			
				<b>Integrity over</b> 0 = Byte or word 1 = Entire length			



**Note:**

MOVIDRIVE® does not support the "Special identifier formats" coding. Only use the "Integrity over entire length" setting for data transmission.

**Data integrity**

Consistent data is data that has to be transmitted between the programmable controller and the drive inverter as one block at all times and must never be transmitted separately. Data integrity is especially important for the transmission of positioning values or complete positioning tasks. Inconsistent transmission may contain data from different program cycles of the automation device. This would lead to undefined values being transmitted to the drive inverter.

For PROFIBUS DP, data communication between the programmable controller and drive engineering devices is usually carried out with the setting "Data integrity over entire length".



#### 5.2.5 MOVIDRIVE® MDX61B external diagnostics

For MOVIDRIVE® MDX61B drive inverters with option DFP21B, it is possible to activate automatic generation of external diagnostic alarms via PROFIBUS DP during the project planning in the DP master. If this function has been activated, the inverter sends an external diagnostic signal to the DP master every time a malfunction occurs. You then have to program corresponding algorithms in the program of the DP master system to evaluate the diagnostic information. These algorithms can be quite complex.

#### Recommendation

It is not always necessary to activate the external diagnostic function because MOVIDRIVE® transmits the current drive status via status word 1 during every PROFIBUS DP cycle.

The structure of the unit-specific diagnostics was redefined for PROFIBUS DP-V1. The mechanism described here can only be used with PROFIBUS DP (without DP-V1 expansions). We recommend that you do not use this mechanism for new applications.



#### Note for SIMATIC S7 master systems:

Diagnostic alarms may also be triggered by the PROFIBUS DP system in the DP master even if external diagnostic generation is deactivated. As a result, the corresponding operating blocks (such as OB84 for S7-400 and OB82 for S7-300) should always be created in the controller.

#### Procedure

Additional application-specific parameters can be defined in every DP master during project planning for a DP slave. These parameters are transferred to the slave when the PROFIBUS DP starts up. Nine application-specific parameter data items are provided for MOVIDRIVE® with the following functions:

Byte:	Permitted value	Function
0	00 hex	Reserved for DP-V1
1	00 hex	Reserved for DP-V1
2	00 hex	Reserved for DP-V1
3	06 hex	Structured user parameter block with a length of 6 bytes
4	81 hex	Structure type: User (proprietary)
5	00 hex	Slot number: 0 = complete unit
6	00 hex	Reserved
7	01 hex	SEW user parameter version: 1
8	00 hex 01 hex	DFP21 generates a diagnostic alarm when a malfunction occurs. DFP21 does not generate a diagnostic alarm when a malfunction occurs (factory setting).

Values not listed here are not permitted as they can cause malfunctions in the DFP21B.





**Project planning example**

The project planning programs of the DP master systems either offer the option of activating the external diagnostics in plain text format, such as with STEP7 (Figure 5), or of stating the information directly in hex code.

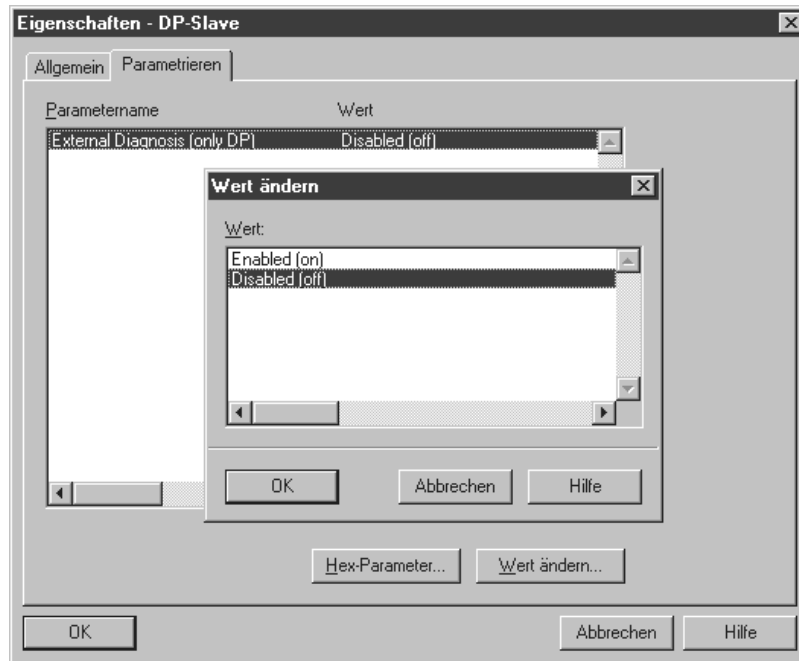

Figure 5: Activating external diagnostics with STEP7

50256AXX

Parameter data (hex)	Function
00, 00, 00, 06, 81, 00, 00, 01, 00	Diagnostic alarms are generated even in case of an error (enabled = on)
00, 00, 00, 06, 81, 00, 00, 01, 01	Diagnostic alarms are <b>not</b> generated if there is an error (disabled = off, factory setting)



#### 5.3 DP master project planning with MOVITRAC® or gateway GSD file

This section provides information on project planning for the PROFIBUS DP master with MOVITRAC® B and DFP21B gateway / UOH11B.

##### 5.3.1 GSD files for operation in MOVITRAC® B and UOH11B gateway housing

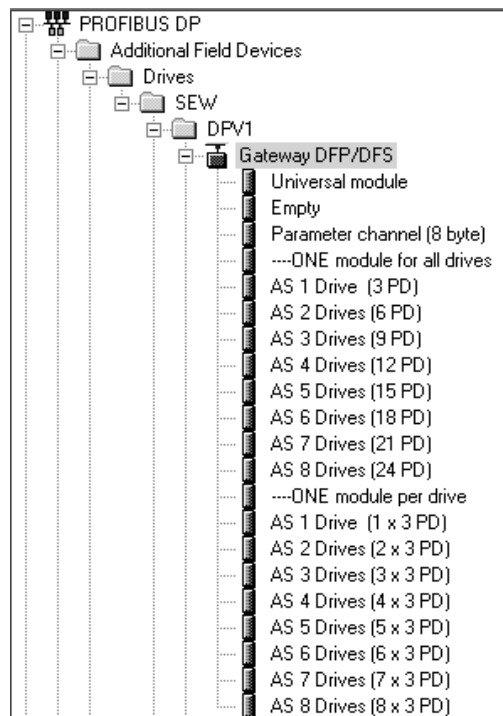

11328AEN

Use the GSD file SEW\_6009.GSD from the "DPV1" directory if you want to use the DFP21B as a gateway from PROFIBUS DP-V1 on the SBus to control the drive inverter.

This GSD file corresponds to GSD revision 5.

Refer to the manuals of the appropriate project planning software for details on the procedure.

The unit master data files standardized by the PROFIBUS user group can be read by all PROFIBUS DP masters.

Project planning tool	DP master	File name
All DP project planning tools to EN50170 (V2)	for DP master standard	SEW_6009.GSD
Siemens S7 hardware configuration	for all S7 DP masters	



### 5.3.2 PROFIBUSDP master startup

Supporting files for DFP21B gateway are available in the Internet at <http://www.sew-eurodrive.de>.

- Observe the notes in the README.TXT file on the GSD disk.
- Install the GSD file according to the requirements of the project planning software for the DP master. After successful installation, the "DFP21B gateway" device appears in the list of slave stations.
- Insert the interface module into the PROFIBUS structure under the name "DFP21B-Gateway" and assign the PROFIBUS address.
- Select the process data configuration required for your application (see section 5.3.3 on page 36).
- Enter the I/O or peripheral addresses for the projected data widths.
- Save the configuration.
- Add data exchange with the fieldbus interface to your application program. For S7, use the system functions for consistent data exchange for this purpose (SFC14 and SFC15).
- The **BUS FAULT** LED at the fieldbus interface should extinguish after you have saved the project, loaded it in the DP master and started the DP master. If this is not the case, check the connections and terminating resistors of the PROFIBUS and the project planning, especially the PROFIBUS address.



#### 5.3.3 Configuration of the PROFIBUSDP interface

##### General

The inverter must be given a specific DP configuration by the DP master to define type and number of input and output data used for the transmission. You can control the drives via process data and read and write all parameters of the fieldbus interface via the parameter channel.

The figure shows a schematic view of the data exchange between automation device (DP-V1 master), fieldbus interface (DP-V1 slave) and an inverter with process data channel and parameter channel.

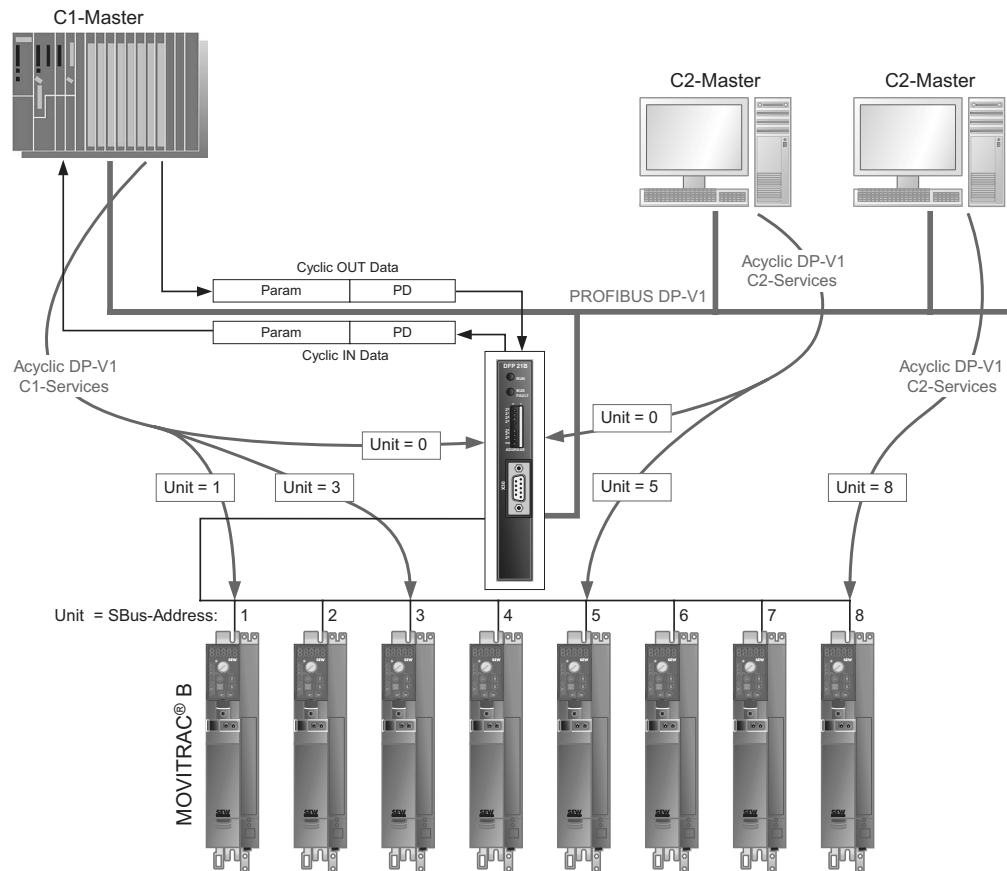

Figure 6: Data exchange with parameter data (Param) and process data (PD)

59093AXX



**Configuration of the process data**

The fieldbus interface allows for different DP configurations for the data exchange between DP master and fieldbus interface. The following table provides additional details on all standard DP configurations of the fieldbus interfaces. The "Process data configuration" column lists the names of the configurations. This text is also displayed as selection list within the project planning software for the DP master. The DP configurations column shows the type of configuration data sent to the fieldbus interface while the link to PROFIBUS DP is being established. The configurations are determined by the default process data width for SEW inverters of 3 process data words. The fieldbus interface then distributes these process data words to the individual units. The parameter channel is used for setting the parameters of the DFP21B and is not passed on to the connected stations. The fieldbus interface accepts between 1 to 24 process data words with and without parameter channel.

The standard entries of the GSD file are based on the DFP21B Autosetup operating mode and allow process data widths of 3PD to 24PD corresponding to 1 to 8 inverters connected to the fieldbus interface.



**3 PDs are always assigned to any SBus station.**

*ONE module for all drives*

The process data is transmitted in **one** consistent data block for all inverters connected to the fieldbus interface. Thus, only system functions SFC14 and SFC15 need to be called in STEP7.

*One module per drive*

One consistent data block exists for each connected inverter. On the controller, this corresponds to the existing setup of several inverters with their own fieldbus interface. System functions SFC14 and SFC15 need to be called for each inverter in STEP7.



Drive parameters of connected MOVITRAC® B inverters can only be accessed using the DP-V1 parameter services.



Process data configuration	Description	Slot 1 Empty	Slot 2 Parameter channel	Slot 3 Drive 1	Slot 4 Drive 2	Slot 5 Drive 3	Slot 6 Drive 4	Slot 7 Drive 5	Slot 8 Drive 6	Slot 9 Drive 7	Slot 10 Drive 8
<b>ONE module for all drives</b>											
Param	8 byte parameter channel	00hex	C0hex, 87hex, 87hex								
AS 1 Drive (3 PD)	Control via 3 PD	00hex		C0hex, C2hex, C2hex							
AS 2 Drives (6 PD)	Control via 6 PD	00hex		C0hex, C5hex, C5hex							
AS 3 Drives (9 PD)	Control via 9 PD	00hex		C0hex, C8hex, C8hex							
AS 4 Drives (12 PD)	Control via 12 PD	00hex		C0hex, CBhex, CBhex							
AS 5 Drives (15 PD)	Control via 15 PD	00hex		C0hex, CEhex, CEhex							
AS 6 Drives (18 PD)	Control via 18 PD	00hex		C0hex, D1hex, D1hex							
AS 7 Drives (21 PD)	Control via 21 PD	00hex		C0hex, D4hex, D4hex							
AS 8 Drives (24 PD)	Control via 24 PD	00hex		C0hex, D7hex, D7hex							
<b>ONE module per drive</b>											
Param	8 byte parameter channel	00hex	C0hex, 87hex, 87hex								
AS 1 Drive (1 x 3 PD)	Control via 1x3 PD	00hex		C0hex, C2hex, C2hex							
AS 2 Drives (2 x 3 PD)	Control via 2x3 PD	00hex		C0hex, C2hex, C2hex	C0hex, C2hex, C2hex						
AS 3 Drives (3 x 3 PD)	Control via 3x3 PD	00hex		C0hex, C2hex, C2hex	C0hex, C2hex, C2hex	C0hex, C2hex, C2hex					
AS 4 Drives (4 x 3 PD)	Control via 4x3 PD	00hex		C0hex, C2hex, C2hex	C0hex, C2hex, C2hex	C0hex, C2hex, C2hex	C0hex, C2hex, C2hex				
AS 5 Drives (5 x 3 PD)	Control via 5x3 PD	00hex		C0hex, C2hex, C2hex	C0hex, C2hex, C2hex	C0hex, C2hex, C2hex	C0hex, C2hex, C2hex	C0hex, C2hex, C2hex			
AS 6 Drives (6 x 3 PD)	Control via 6x3 PD	00hex		C0hex, C2hex, C2hex	C0hex, C2hex, C2hex	C0hex, C2hex, C2hex	C0hex, C2hex, C2hex	C0hex, C2hex, C2hex	C0hex, C2hex, C2hex		
AS 7 Drives (7 x 3 PD)	Control via 7x3 PD	00hex		C0hex, C2hex, C2hex	C0hex, C2hex, C2hex	C0hex, C2hex, C2hex	C0hex, C2hex, C2hex	C0hex, C2hex, C2hex	C0hex, C2hex, C2hex	C0hex, C2hex, C2hex	
AS 8 Drives (8 x 3 PD)	Control via 8x3 PD	00hex		C0hex, C2hex, C2hex	C0hex, C2hex, C2hex	C0hex, C2hex, C2hex	C0hex, C2hex, C2hex	C0hex, C2hex, C2hex	C0hex, C2hex, C2hex	C0hex, C2hex, C2hex	C0hex, C2hex, C2hex



**"Universal module"  
DP configuration**

Module 0 must always be pre-assigned to 0x00.

The "Universal Module" (such as in STEP7) allows you to set the parameters of the fieldbus interface deviating from the preset standard values of the GSD file. This is useful if you want to operate several inverters with different process data words at the fieldbus interface, for example.

You must observe the following conditions:

- Module 1 defines the parameter channel of the inverter. Entering 0 will switch off the parameter channel; entering 0xC0 0x87 0x87 will switch on the parameter channel with 8 bytes length.
- The following modules determine the process data width of the fieldbus interface at the PROFIBUS. The added process data width of all following modules must be between 1 and 24 words. For safety reasons, the modules must be listed with data integrity. Ensure that an inverter connected to the fieldbus interface is represented by such a consistent module entry.
- Only the special identifier format is permitted.

**Operating mode  
(DP-V1 mode)**

The DP-V1 operating mode can usually be activated during project planning for a C1 master. All DP slaves, which have the DP-V1 functions enabled in their GSD files and which support DP-V1, will then be operated in the DP-V1 mode. Standard DP slaves will still run via PROFIBUS DP. This ensures mixed mode is run for DP-V1 and DP-capable modules. Depending on the specification of the master functionality, a DP-V1-capable station, that was configured using the DP-V1 GSD file, can run in the "DP" operating mode.



#### 5.3.4 Autoseup for gateway operation

The Autoseup function enables startup of the DFP21B as gateway to be performed without a PC. Activate the function via the Autoseup DIP switch (see section 4.4 on page 20).



Switching on the Autoseup DIP switch causes the function to be performed once. **The Autoseup DIP switch must then remain in the ON position.** The function can be performed again by switching the DIP switch off and back on again.

As a first step, the DFP21B searches for drive inverters on the SBus below its hierarchical level. This process is indicated by the **H1** LED (system fault) flashing briefly. Different SBus addresses must be set for the drive inverters (P813). We recommend assigning the addresses beginning with address 1 in ascending order based on the arrangement of inverters in the control cabinet. The process image on the fieldbus side is expanded by three words for each detected drive inverter.

The **H1** LED remains lit if no drive inverter was located. A total of up to eight drive inverters is taken into account. The following figure shows the process image for three drive inverters with three words each of process output data and process input data.

Following the search, the DFP21B cyclically exchanges 3 process data words with each connected drive inverter. The process output data is fetched from the fieldbus, divided into blocks of three and transmitted. The drive inverters read the process input data, put them together and send them to the fieldbus master.

The cycle time of the SBus communication requires 2 ms for each station.

This means the cycle time of the process data update is  $8 \times 2 \text{ ms} = 16 \text{ ms}$  for an application with 8 inverters on the SBus.



If you change the process data assignment of the drive inverters connected to the DFP21B, you have to activate Autoseup again because the DFP21B saves these values only once during Autoseup. At the same time, the process data assignments of the connected drive inverters may not be changed dynamically after Autoseup.



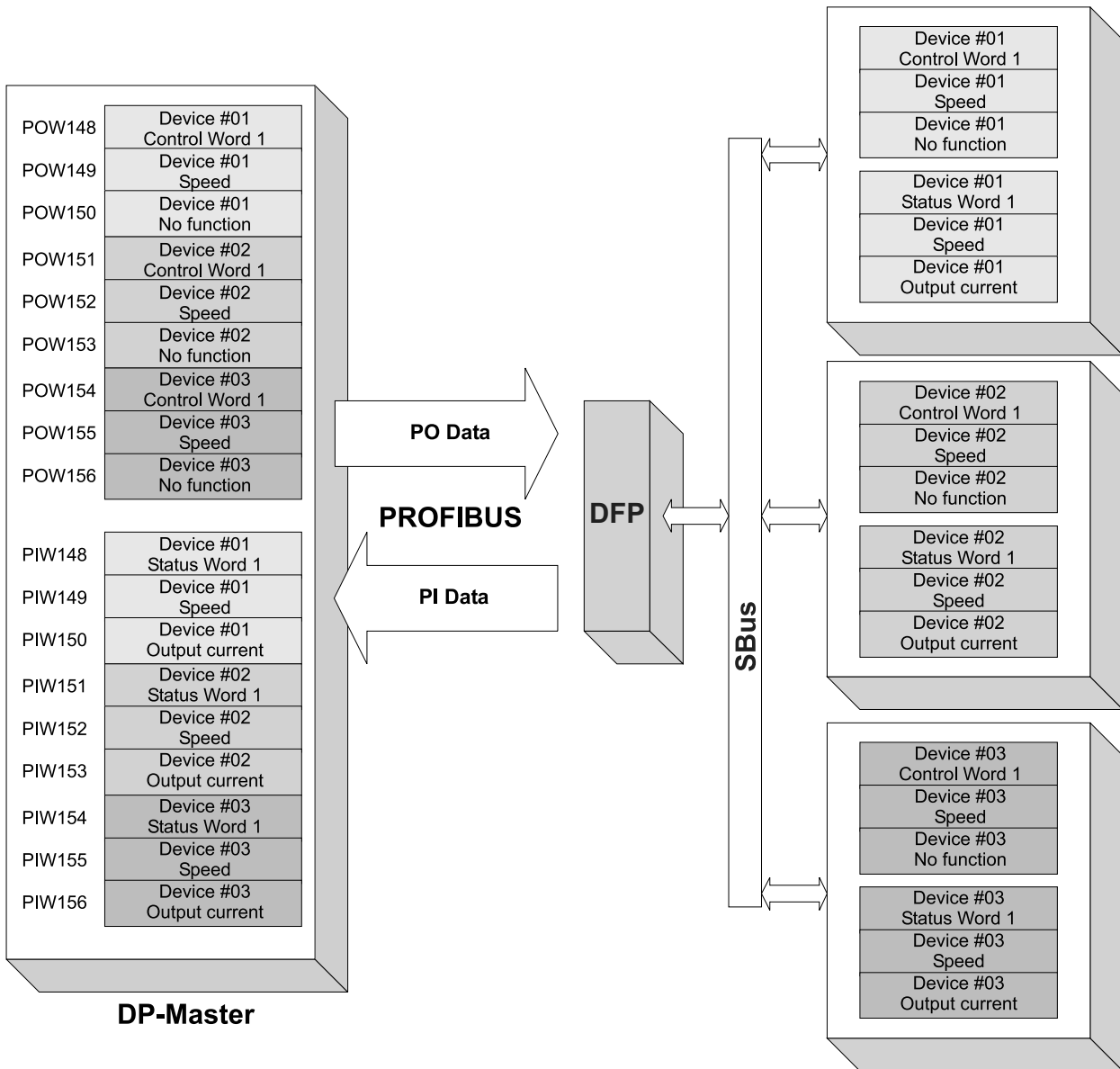
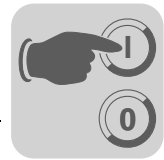

59442AXX

Figure 7: Data exchange DP-V1 master DFP inverter



#### 5.4 Setting the MOVIDRIVE® MDX61B drive inverter

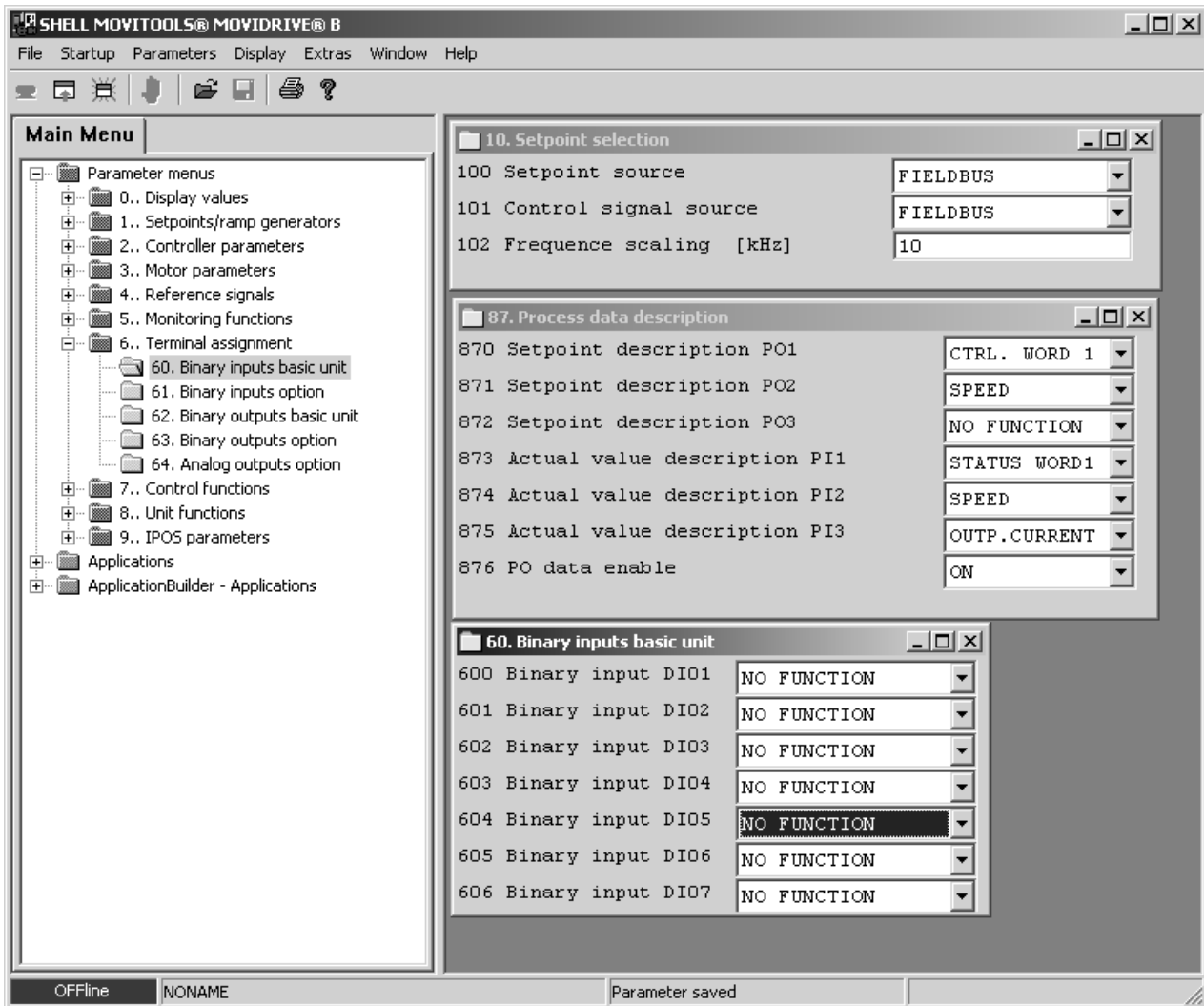

11330AEN

To control the drive inverter via PROFIBUS, you must first switch the drive inverter to control signal source (P101) and setpoint source (P100) = FIELDBUS. The FIELDBUS setting means the drive inverter parameters are set for acceptance of setpoints via PROFIBUS. The MOVIDRIVE® drive inverter then responds to the process output data transmitted from the master programmable controller.

The parameters of the MOVIDRIVE® drive inverter can be set right away via PROFIBUS without any further settings once the PROFIBUS option card has been installed. For example, all parameters can be set by the master programmable controller after being switched on.



Activation of the control signal source and setpoint source FIELDBUS is signaled to the machine control using the "Fieldbus mode active" bit in the status word.

For safety reasons, you must also enable the drive inverter at the terminals for control via the fieldbus system. Therefore, you must wire and program the terminals in such a way that the inverter is enabled via the input terminals. The simplest way of enabling the drive inverter at the terminals is, for example, to connect the DIØØ (function /CONTROLLER INHIBIT) input terminal to a +24-V signal and to program input terminals DIØ1 ... DIØ3 to NO FUNCTION. The procedure for startup of the MOVIDRIVE® drive inverter with a fieldbus connection is described on the next page.

### 5.5 Setting the MOVITRAC® frequency inverter

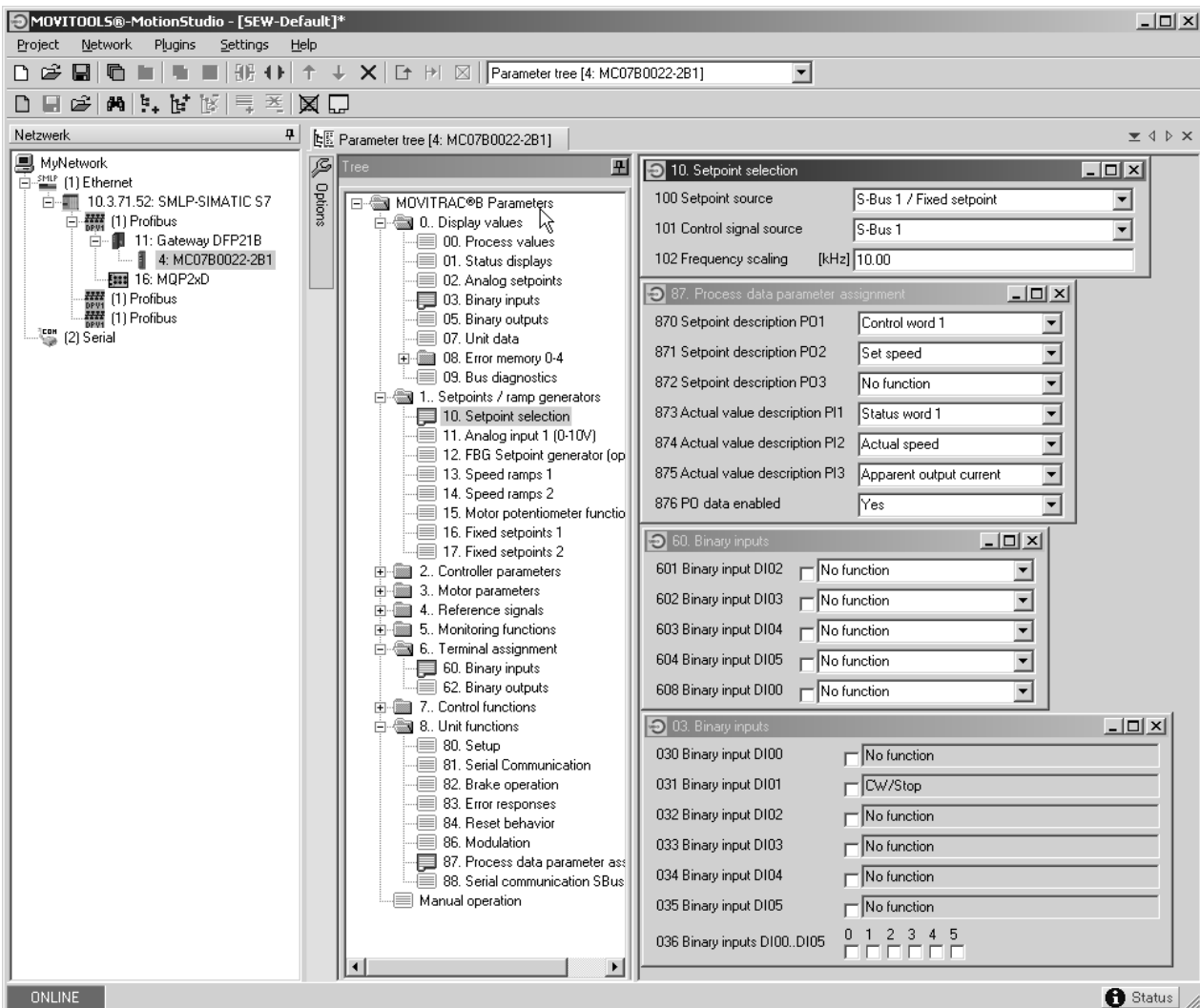

11329AEN



## Project Planning and Startup

### Setting the MOVITRAC® frequency inverter

---

To control the drive inverter via PROFIBUS, you must first switch the drive inverter to *control signal source (P101)* and *setpoint source (P100) = SBus*. The SBus setting means the drive inverter parameters are set for control and setpoint entry via gateway. The MOVITRAC® drive inverter then responds to the process output data transmitted from the master programmable controller.

It is necessary to set the SBus1 timeout interval (P815) to a value other than 0 ms for the MOVITRAC® frequency inverter to stop if faulty SBus communication is encountered. We recommend a value in the range 50 to 200 ms.

Activation of the control signal source and setpoint source SBus is signaled to the machine control using the "SBus mode active" bit in the status word.

For safety reasons, you must also enable the drive inverter at the terminals for control via the fieldbus system. Therefore, you must wire and program the terminals in such a way that the inverter is enabled via the input terminals. The simplest way of enabling the drive inverter at the terminals is, for example, to connect the DI1 (function CW/STOP) input terminal to a +24-V signal and to program the remaining input terminals to NO FUNCTION.



Set the parameter *P881 SBus address* to values between 1 to 8 in ascending order. The SBus address 0 is used by DFP21B gateway and therefore must not be used. Set *P883 SBus timeout* to values between 50 to 200 ms.

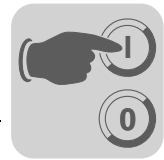

## 6 PROFIBUSDP Operating Characteristics

This section describes the basic characteristics of the drive inverter with PROFIBUS DP.

### 6.1 Controlling the MOVIDRIVE® MDX61B drive inverter

The drive inverter is controlled via the process data channel, which is up to 10 I/O words in length. These process data words may be mapped in the I/O or peripheral area of the control if a programmable control is used as DP master and can be addressed as usual.

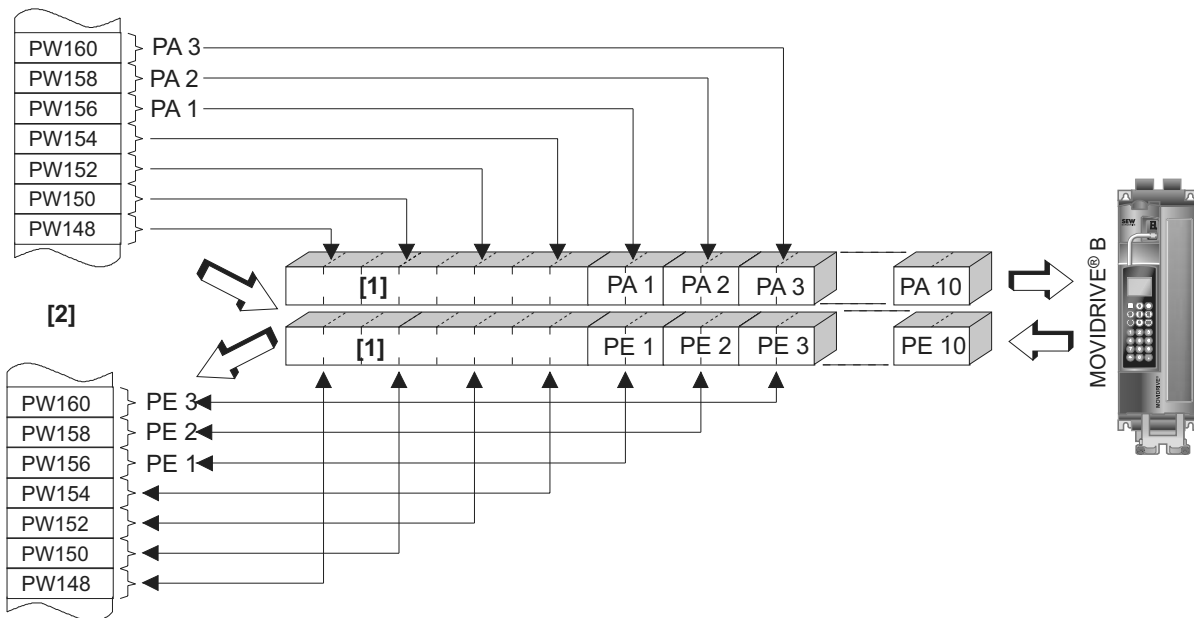

58688AXX

Figure 8: Mapping PROFIBUS data in the PLC address range

[1] 8-byte MOVILINK® parameter channel

[2] PLC address range

PE1 ... PE10 Process input data

PA1 ... PO10 Process output data



- For additional information on programming and project planning, refer to the README\_GSDA6003.PDF file included in the GSD file.
- For more information about controlling via the process data channel, in particular regarding the coding of the control and status word, refer to the Fieldbus Unit Profile manual.



#### 6.1.1 Control example for SIMATIC S7 with MOVIDRIVE® MDX61B

The drive inverter is controlled using SIMATIC S7 in accordance with the selected process data configuration either directly using load and transfer commands or by means of special system functions, *SFC 14 DPRD\_DAT* and *SFC15 DPWR\_DAT*.

S7 data lengths of 3 bytes or more than 4 bytes must always be transmitted using system functions SFC14 and SFC15.

Consequently, the data in the following table applies:

Process data configuration	STEP7 access via
1 PD	Load / transfer commands
2 PD	Load / transfer commands
3 PD	System functions SFC14/15 (length: 6 bytes)
6 PD	System functions SFC14/15 (length: 12 bytes)
10 PD	System functions SFC14/15 (length: 20 bytes)
Param + 1 PD	Parameter channel: System functions SFC14/15 (length: 8 bytes) Process data: Load / transfer commands
Param + 2 PD	Parameter channel: System functions SFC14/15 (length: 8 bytes) Process data: Load / transfer commands
Param + 3 PD	Parameter channel: System functions SFC14/15 (length: 8 bytes) Process data: System functions SFC14/15 (length: 6 bytes)
Param + 6 PD	Parameter channel: System functions SFC14/15 (length: 8 bytes) Process data: System functions SFC14/15 (length: 12 bytes)
Param + 10 PD	Parameter channel: System functions SFC14/15 (length: 8 bytes) Process data: System functions SFC14/15 (length: 20 bytes)

#### 6.1.2 PROFIBUSDP timeout (MOVIDRIVE® MDX61B)

If the data transfer via PROFIBUS DP is faulty or interrupted, the response monitoring time in MOVIDRIVE® elapses (if configured in the DP master). The **BUS-FAULT** LED lights up or flashes to indicate that no new user data is being received. At the same time, MOVIDRIVE® performs the fault response selected with *P831 Fieldbus timeout response*.

*P819 Fieldbus timeout* displays the response monitoring time specified by the DP master during the PROFIBUS DP startup. The timeout can only be changed via the DP master. Although modifications made using the keypad or MOVITools® are displayed, they do not have any effect and are overwritten when the DP is next started up.

#### 6.1.3 Fieldbus timeout response (MOVIDRIVE® MDX61B)

P831 is used to set the parameters for the fault response, which is triggered by the fieldbus timeout monitoring. The setting made here must correspond to the setting in the master system (S7: response monitoring).



## 6.2 Control of the MOVITRAC® inverter (gateway)

The inverter is controlled via the process data channel, which is up to 3 I/O words in length. These process data words are reproduced in the I/O or peripheral area of the controller, for example when a programmable logic controller is used as the DP master. As a result, they can be addressed in the usual manner.

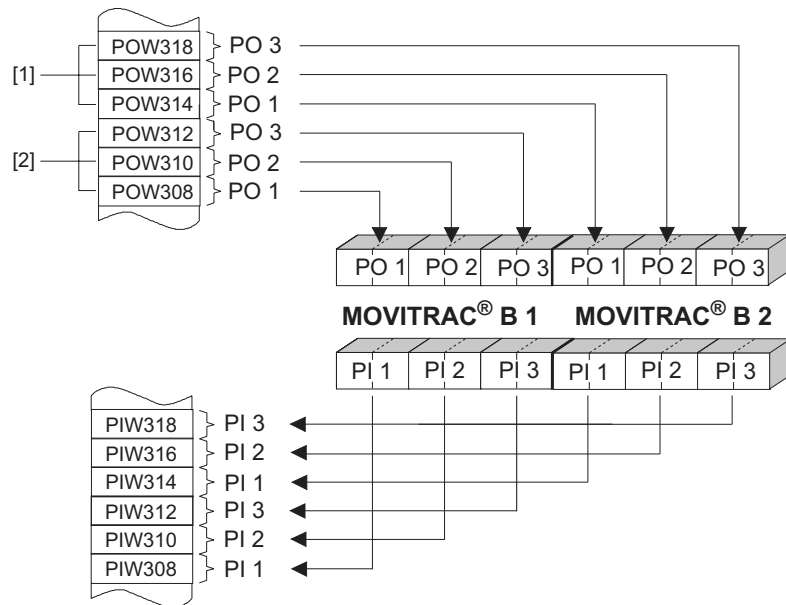

58612AXX

Figure 9: Mapping PROFIBUS data in the PLC address range

- [1] Address range MOVITRAC® B, device 2
- [2] Address range MOVITRAC® B, device 1

PO = process output data / PI = process input data

Additional information on programming and project planning can be found in the README\_GSD6009.PDF file included in the GSD file.



#### 6.2.1 Control example for SIMATIC S7 with MOVITRAC® B (gateway)

The drive inverter is controlled via SIMATIC S7 depending on the selected process data configuration, either directly via load and transfer commands or via the special system functions SFC 14 DPRD\_DAT and SFC15 DPWR\_DAT.

S7 data lengths of 3 bytes or more than 4 bytes must always be transmitted using system functions SFC14 and SFC15.

Process data configuration	STEP7 access via
3 PD...24 PD	System functions SFC14/15 (length: 6...48 bytes)
Param + 3 PD...24 PD	System functions SFC14/15 (length 6...48 bytes for PD + 8 bytes for parameter)

#### STEP7 program example

The "README\_GSD6009.PDF" file contains project planning and programming examples for SIMATIC S7. See also section 6.4 on page 55.

#### 6.2.2 SBus timeout

If one or more drive inverters on the SBus can no longer be addressed by the DFP21, the gateway enters error code *F11 System fault*, in status word 1 of the corresponding drive inverter. The **H1** LED (system fault) lights up, and the fault is also displayed via the diagnostics interface. It is necessary to set the *SBus timeout interval (P815)* of the MOVITRAC® B system error to a value other than 0 for the drive inverter to stop. The error resets itself in the gateway. In other words, the current process data is exchanged immediately after restarting the communication.

#### 6.2.3 Unit faults

The gateways detect a series of faults during the self test and respond by locking themselves. The exact error responses and remedies can be found in the list of errors. A hardware defect causes error *F111 system fault* to be displayed on the fieldbus process input data for status words 1 of all drive inverters. The **H1** LED (system fault) at the DFP21B then flashes at regular intervals. The exact error code is displayed in the status of the gateway using MOVITOOLS® MotionStudio on the diagnostic interface.





### 6.2.4 Fieldbus timeout of the DFP21B in gateway operation

You can set how the gateway should respond in case of timeout using the *P831 Fieldbus timeout response* parameter.

No response	The drives on the subordinate SBus continue with the last setpoint value. These drives cannot be controlled when the PROFIBUS communication is interrupted.
PA_DATA=0	The rapid stop is activated for all drives that have a process data configuration with control word 1 or 2 when a PROFIBUS timeout is detected. For this purpose, the gateway sets the bits 0 to 2 of the control word to 0. The drives are stopped with the rapid stop ramp.

## 6.3 Parameter settings via PROFIBUS DP

With PROFIBUS DP, the drive parameters are accessed via the 8-byte MOVILINK<sup>®</sup> parameter channel. This channel offers extra parameter services in addition to the conventional READ and WRITE services.



The inverter parameter settings via the PROFIBUS DP parameter channel can only be used for MOVIDRIVE<sup>®</sup> MDX61B and the parameters of the DFP21B gateway.

The PROFIBUS DP parameter channel does not provide data access to the parameters of the inverter that are installed below the gateway at the SBus.

### 6.3.1 Structure of the 8-byte MOVILINK<sup>®</sup> parameter channel

PROFIBUS DP enables access to the inverter drive parameters via the "Parameter process data object" (PPO). This PPO is transmitted cyclically and contains the process data channel [2] and a parameter channel [1] that can be used to exchange acyclical parameter values.

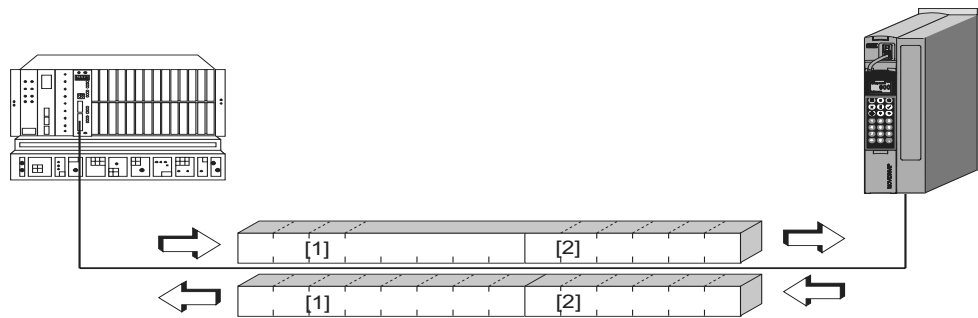

53492AXX

Figure 10: Communication via PROFIBUS DP



The following table shows the structure of the 8-byte MOVILINK<sup>®</sup> parameter channel. Essentially, the parameter channel is made up of a management byte, an index word, a reserved byte and four data bytes.

Byte 0	Byte 1	Byte 2	Byte 3	Byte 4	Byte 5	Byte 6	Byte 7
Management	Subindex	Index high	Index low	MSB data	Data	Data	LSB data
		Parameter index		4 byte data			

#### Management of the 8-byte MOVILINK<sup>®</sup> parameter channel

The entire procedure for setting parameters is coordinated using management byte 0. This byte provides important service parameters such as service identifier, data length, version and status of the service performed. The following table shows that bits 0, 1, 2 and 3 contain the service identifier, and define which service is performed. Bit 4 and bit 5 specify the data length in bytes for the WRITE service. This should be set to 4 bytes for all SEW drive inverters.

7 / MSB	6	5	4	3	2	1	0 / LSB
				<b>Service identifier</b> 0000 = No service 0001 = READ parameter 0010 = WRITE parameter  0110 = READ default 0111 = READ scale 1000 = READ attribute			
		<b>Data length</b> 00 = 1 byte 01 = 2 bytes 10 = 3 bytes 11 = 4 bytes (must be set)					
	<b>Handshake bit</b> Must be changed on every new task in cyclical transmission.						
<b>Status bit</b> 0 = No error during service execution 1 = Error during service execution							

Bit 6 is used as a handshake between the control and the drive inverter. It triggers the implementation of the transferred service in the drive inverter. In PROFIBUS DP, the parameter channel is transmitted cyclically with the process data. For this reason, the implementation of the service in the drive inverter must be triggered by edge control using the handshake bit 6. For this purpose, the value of this bit is altered for each new service that is to be executed. The drive inverter uses the handshake bit to signal whether the service has been executed or not. The service was executed if the handshake bit received in the control is identical with the transmitted handshake bit. Status bit 7 indicates whether it was possible to execute the service properly or if errors occurred.



**Index addressing** Byte 2 (Index high) and byte 3 (Index low) determine the parameter which is to be read or written via the fieldbus system. The parameters of a drive inverter are addressed with a uniform index regardless of the fieldbus system that is connected. Byte 1 should be viewed as reserved and must always be set to 0x00.

**Data range** As shown in the following table, the data is contained in bytes 4 through 7 of the parameter channel. This means up to 4 bytes of data can be transmitted per service. The data is always entered with right-justification. In other words, byte 7 contains the least significant data byte (LSB data) whereas byte 4 is the most significant data byte (MSB data).

Byte 0	Byte 1	Byte 2	Byte 3	Byte 4	Byte 5	Byte 6	Byte 7
Management	Subindex	Index high	Index low	MSB data	Data	Data	LSB data
				High byte 1	Low byte 1	High byte 2	Low byte 2
				High word		Low word	
				Double word			

**Incorrect service execution** The status bit in the management byte is set to signal that a service has been executed incorrectly. The service was executed by the drive inverter if the received handshake bit is the same as the sent handshake bit. If the status bit now signals an error, the error code is entered in the data range of the parameter telegram. Bytes 4 through 7 send back the return code in a structured format. See section 6.5 on page 56.

Byte 0	Byte 1	Byte 2	Byte 3	Byte 4	Byte 5	Byte 6	Byte 7
Management	Subindex	Index high	Index low	Error class	Error code	Add. code high:	Add. code low
Status bit = 1: Incorrect service execution							



#### 6.3.2 Reading a parameter with PROFIBUS DP (READ)

Due to the cyclical transfer of the parameter channel, to execute a READ service via the 8-byte MOVILINK<sup>®</sup> parameter channel, the handshake bit may only be changed if the complete parameter channel has been set up for the specific service. For this reason, observe the following sequence when reading a parameter:

1. Enter the index of the parameter to be read in byte2 (index high) and byte3 (index low).
2. Enter the service identifier for the READ service in the management byte (byte0).
3. Transfer the READ service to the inverter by changing the handshake bit.

Since this is a read service, the sent data bytes (bytes 4 through 7) and the data length (in the management byte) are ignored and consequently do not need to be set.

The inverter now processes the READ service and sends the service confirmation back by changing the handshake bit.

7 / MSB	6	5	4	3	2	1	0 / LSB
0	0/1 <sup>1)</sup>	X <sup>2)</sup>	X <sup>2)</sup>	0	0	0	1
				<b>Service identifier</b> 0001 = READ parameter			
				<b>Data length</b> Not relevant for READ service			
				<b>Handshake bit</b> Must be changed on every new task in cyclical transmission.			
<b>Status bit</b> 0 = No error during service execution 1 = Error during service execution							

- 1) Bit value is changed
- 2) Not relevant

The above table shows how a READ service is coded in the management byte. The data length is not relevant, you only need to enter the service identifier for the READ service. This service is now activated in the drive inverter when the handshake bit changes. For example, it would be possible to activate the READ service with the management byte coding 01hex or 41hex.



### 6.3.3 Writing a parameter via PROFIBUS DP (WRITE)

Due to the cyclical transfer of the parameter channel, to execute a WRITE service via the 8-byte MOVILINK® parameter channel, the handshake bit may only be changed if the complete parameter channel has been set up for the specific service. For this reason, observe the following sequence when writing a parameter:

1. Enter the index of the parameter to be written in byte 2 (index high) and byte 3 (index low).
2. Enter the data to be written in bytes 4 through 7.
3. Enter the service identifier and the data length for the WRITE service in the management byte (byte 0).
4. Transfer the WRITE service to the inverter by changing the handshake bit.

The inverter now processes the WRITE service and sends the service confirmation back by changing the handshake bit.

The following table shows how a WRITE service is coded in the management byte. The data length is 4 bytes for all parameters of SEW drive inverters. This service is now transferred to the drive inverter when the handshake bit changes. As a result, a WRITE service on SEW drive inverters generally has the management byte coding 32hex or 72hex.

7 / MSB	6	5	4	3	2	1	0 / LSB
0	0/1 <sup>1)</sup>	1	1	0	0	1	0
				<b>Service identifier</b> 0010 = WRITE Parameter			
				<b>Data length</b> 11 = 4 bytes			
				<b>Handshake bit</b> Must be changed on every new task in cyclical transmission.			
<b>Status bit</b> 0 = No error during service execution 1 = Error during service execution							

1) Bit value is changed



#### 6.3.4 Parameter setting procedure with PROFIBUS DP

Using the WRITE service as an example, the following figure represents a process of setting parameters between the controller and the drive inverter via PROFIBUS DP. To simplify the procedure, the following figure only shows the management byte of the parameter channel.

The parameter channel is only received and returned by the drive inverter while the control is preparing the parameter channel for the WRITE service. The service is not activated until the moment when the handshake bit is changed (in this example, when it changes from 0 to 1). The drive inverter now interprets the parameter channel and processes the WRITE service; however, it continues to respond to all telegrams with handshake bit = 0. Confirmation that the service has been performed occurs when the handshake bit in the response telegram of the drive inverter is changed. The control now detects that the received handshake bit is once again the same as the one that was sent. It can now prepare another parameter setting procedure.

Control	PROFIBUS DP(V0)	Drive inverter (slave)
	-- 00110010XXX... →	Parameter channel is received, but not evaluated
	← 00110010XXX... --	
Parameter channel is prepared for the WRITE service		
Handshake bit is changed and the service is transferred to the drive inverter	-- 01110010XXX... →	
	← 00110010XXX... --	
	-- 01110010XXX... →	
	← 00110010XXX... --	WRITE service is performed, handshake bit is changed
Service confirmation is received as the send and receive handshake bits are the same again	← 01110010XXX... --	
	-- 01110010XXX... →	Parameter channel is received, but not evaluated

#### 6.3.5 Parameter data format

When parameters are set via the fieldbus interface, the same parameter coding is used as with the serial RS-485 interfaces or the system bus.

The data formats and ranges of values for the individual parameters can be found in the publication "MOVIDRIVE<sup>®</sup> Parameter List".



## 6.4 SIMATIC STEP7 program example



This example is a special and free service that demonstrates only the basic approach to generating a PLC program without commitment. We are not liable for the contents of the program example.

In this example, the project planning for MOVIDRIVE® or MOVITRAC® has the process data configuration "3 PD" on input addresses PIW576... and output addresses POW576...

A data block DB3 is created with about 50 data words.

When SFC14 is called, the process input data is copied to data block DB3, data words 0, 2 and 4. When SFC15 is called after the control program has been processed, the process output data are copied from data words 20, 22 and 24 to the output address POW 576 ...

Note the length information in bytes for the RECORD parameter. The length information must correspond to the configured length.

Refer to the online help for STEP7 for further information about the system functions.

```
//Start of cyclical program processing in OB1
BEGIN
NETWORK
TITLE =Copy PI data from inverter to DB3, words 0/2/4
CALL SFC 14 (DPRD_DAT) //READ DP slave record
  LADDR := W#16#240 //Input address 576
  RET_VAL:= MW 30 //Result in flag word 30
  RECORD := P#DB3.DBX 0.0 BYTE 6 //Pointer
NETWORK
TITLE =PLC program with drive application
// PLC program uses the process data in DB3 for
// controlling the drive
L DB3.DBW 0//Load PI1 (status word 1)
L DB3.DBW 2 //Load PI2 (actual speed value)
L DB3.DBW 4 //Load PI3 (no function)

L W#16#0006
T DB3.DBW 20//Write 6hex to PO1 (control word = enable)
L 1500
T DB3.DBW 22//Write 1500dec to PO2 (speed setpoint = 300 rpm)
L W#16#0000
T DB3.DBW 24//Write 0hex to PO3 (however, it has no function)

//End of cyclical program processing in OB1
NETWORK
TITLE =Copy PO data from DB3, word 20/22/24 to inverter
CALL SFC 15 (DPWR_DAT) //WRITE DP Slave Record
  LADDR := W#16#240 //Output address 576 = 240hex
  RECORD := P#DB3.DBX 20.0 BYTE 6 //Pointer to DB/DW
  RET_VAL:= MW 32 //Result in flag word 32
```



## 6.5 Return codes for parameter setting

### 6.5.1 Elements

In the event of an incorrect parameter setting, the drive inverter sends back various return codes to the master that set the parameters. These codes provide detailed information about what caused the error. Generally, these return codes are structured. The system distinguishes between the following elements:

- Error class
- Error code
- Additional code

These return codes are described in detail in the Fieldbus Communications Profile manual and are not included in this documentation. However, the following special cases can occur in connection with PROFIBUS:

### 6.5.2 Error class

The error class element provides a more exact classification of the error type. MOVIDRIVE<sup>®</sup> supports the following error classes defined in accordance with EN 50170(V2):

Class (hex)	Designation	Meaning
1	vfd state	Status error of the virtual field device
2	application reference	Error in application program
3	definition	Definition error
4	resource	Resource error
5	service	Fault during service execution
6	access	Access error
7	ov	Error in the object directory
8	other	Other error (see section 6.5.4 on page 57)

Except for *Error class 8 = other error*, the error class is generated by the communications software of the fieldbus card when faulty communication is encountered. Return codes sent from the drive inverter system are all in *Error class 8 = other error*. The error can be identified more precisely using the *Additional code* element.

### 6.5.3 Error code

The error code element allows for a more detailed identification of the error cause within the error class and is generated by the communications software of the fieldbus card when faulty communication is encountered. For *Error class 8 = other error*, only *error code = 0* (other error code) is defined. In this case, detailed identification is made using the *Additional code*.





### 6.5.4 Additional code

The additional code contains the return codes specific to SEW dealing with incorrect parameter settings of the drive inverter. They are returned to the master under *Error class 8 = other error*. The following table shows all possible codings for the additional code.

Add. code high (hex)	Add. code low (hex)	Meaning
00	00	No error
00	10	Illegal parameter index
00	11	Function/parameter not implemented
00	12	Read access only
00	13	Parameter lock is active
00	14	Factory setting is active
00	15	Value for parameter too large
00	16	Value for parameter too small
00	17	Required option card missing for this function/parameter
00	18	Error in system software
00	19	Parameter access via RS-485 process interface on X13 only
00	1A	Parameter access via RS-485 diagnostic interface only
00	1B	Parameter is access-protected
00	1C	Control inhibit required
00	1D	Invalid value for parameter
00	1E	Factory setting was activated
00	1F	Parameter was not saved in EEPROM
00	20	Parameter cannot be changed with enabled output stage

## 6.6 Special cases

### 6.6.1 Special return codes

Errors in the parameter settings that cannot be identified either automatically by the application layer of the fieldbus system or by the system software of the drive inverter are treated as special cases. The following is a list of errors that can occur depending on the fieldbus option card used:

- Incorrect coding of a service via parameter channel
- Incorrect length specification of a service via parameter channel
- Internal communication error



#### **Incorrect service code in the parameter channel**

Incorrect code was specified in the management byte or reserved byte during parameter setting via the parameter channel. The following table shows the return code for this special case.

	Code (dec)	Meaning
Error class:	5	Service
Error code:	5	Illegal parameter
Add. code high:	0	–
Add. code low:	0	–

#### *Troubleshooting*

Check bits 0 and 1 in the parameter channel.

#### **Incorrect length specification in parameter channel**

A data length other than 4 data bytes was specified in a READ or WRITE service when setting parameters via the parameter channel. The following table displays the return codes.

	Code (dec)	Meaning
Error class:	6	Access
Error code:	8	Type conflict
Add. code high:	0	–
Add. code low:	0	–

#### *Troubleshooting*

Check bits 4 and 5 for the data length in the management byte of the parameter channel. Both bits must be set to 1.

#### **Internal communication error**

The return code listed in the following table is sent back if a communication error has occurred within the system. The parameter service transferred via the fieldbus may not have been performed and should be repeated. If this error occurs again, switch off the drive inverter completely and then back on again so it is re-initialized.

	Code (dec)	Meaning
Error class:	6	Access
Error code:	2	Hardware fault
Add. code high:	0	–
Add. code low:	0	–

#### *Troubleshooting*

Repeat the READ or WRITE service. If this error occurs again, disconnect the drive inverter from the supply system and then reconnect it. Contact SEW Service for advice if this error occurs continuously.



## 7 PROFIBUSDP-V1 Functions

This section provides you with information about the PROFIBUS DP-V1 functions.

### 7.1 Introduction to PROFIBUS DP-V1

This section describes the functions and terms used for operating SEW drive inverters on PROFIBUS DP-V1. Refer to the PROFIBUS user group or visit [www.profibus.com](http://www.profibus.com) for detailed technical information on PROFIBUS DP-V1.

The PROFIBUS DP-V1 specification introduced new acyclical *READ/WRITE* services as part of the PROFIBUS DP-V1 expansions. These acyclical services are added to the current cyclical bus operation in special telegrams to ensure compatibility with PROFIBUS DP (version 0) and PROFIBUS DP V1 (version 1).

The acyclical *READ/WRITE* services can be used to exchange larger data quantities between master and slave (drive inverter) than it would be possible to transfer in the cyclical input and output data using the 8-byte parameter channel. The advantage of the acyclical data exchange via DP-V1 lies in the minimum load on the cyclical bus operation since DP-V1 telegrams are only added to the bus cycle if required.

The DP-V1 parameter channel provides the user with 2 options:

- The higher-level controller can access all the device information of the SEW DP-V1 slaves. This means that cyclical process data and unit settings can be read, stored in the controller and modified in the slave.
- It is also possible to route the service and startup tool MOVITOOLS<sup>®</sup> MotionStudio via the DP-V1 parameter channel instead of using a proprietary RS-485 connection. Once you have installed the MOVITOOLS<sup>®</sup> MotionStudio software, you can access detailed information in the folder ...\\SEW\\MOVITOOLS\\Fieldbus.

The main features of PROFIBUS DP-V1 are explained below.

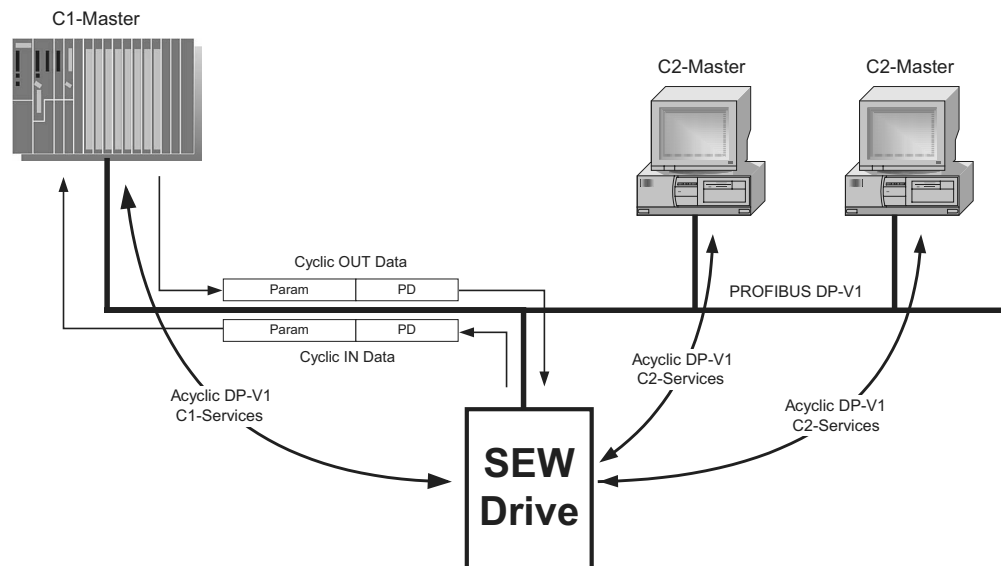

58617AXX



#### 7.1.1 Class 1 master (C1 master)

The PROFIBUSDP-V1 network differentiates between master classes. The C1 master essentially performs the cyclical data exchange with the slaves. A typical C1 master is a control system, such as a PLC, that exchanges cyclical process data with the slave. If the DPV1 function has been activated via the GSD file, the acyclical connection between C1 master and slave is established automatically when the cyclical connection of the PROFIBUS-DP-V1 is being established. Only one C1 master can be operated in a PROFIBUSDP-V1 network.

#### 7.1.2 Class 2 master (C2 master)

The C2 master itself does not perform cyclical data exchange with the slaves. Examples for a typical C2 master are visualization systems or temporary installed programming devices (notebook / PC). The C2 master uses exclusively acyclic connections for communication with the slaves. The acyclic connections between C2 master and slave are established by the *initiate* service. The connection is established once the *initiate* service has been performed successfully. An established connection allows for cyclical data exchange with the slaves by means of *READ* or *WRITE* services. Several C2 masters can be active in a DP-V1 network. The number of C2 connections, established simultaneously for a slave, is determined by the slave. SEW drive inverters support two parallel C2 connections.

#### 7.1.3 Data sets (DS)

The user data transported via a DP-V1 service is collected in data sets. Each data set is represented uniquely by its length, a slot number and an index. The structure of data set 47 is used for DP-V1 communication with the SEW drive inverter. This data set is defined as the DP-V1 parameter channel for drives as of V3.1 in the PROFIdrive profile drive engineering of the PROFIBUS user group. Different procedures for accessing parameter data in the drive inverter are provided via this parameter channel.



#### 7.1.4 DP-V1 services

The DP-V1 expansions offer new services, which can be used for acyclical data exchange between master and slave. The system distinguishes between the following services:

<b>C1 master</b>	<b>Connection type: MSAC1 (master / slave acyclical C1)</b>
READ	Read data set
WRITE	Write data set

<b>C2 master:</b>	<b>Connection type: MSAC2 (master / slave acyclical C2)</b>
INITIATE	Establish C2 connection
ABORT	Disconnect C2 connection
READ	Read data set
WRITE	Write data set

#### 7.1.5 DP-V1 alarm handling

In addition to the acyclical services, the DP-V1 specification also defines extended alarm handling. Alarm handling now distinguishes between different alarm types. As a result, unit-specific diagnostics cannot be evaluated in DP-V1 operation using the "DDL\_M\_SlaveDiag" DP-V0 service. DP-V1 alarm handling has not been defined for drive engineering as a drive inverter does not usually transfer its status information via cyclical process data communication.



#### 7.2 Features of SEW drive inverters

The SEW fieldbus interfaces to PROFIBUS DP-V1 have the same communication features for the DP-V1 interface. The drives are usually controlled via a C1 master with cyclical process data in accordance with the DP-V1 standard. This C1 master (usually a PLC) can also use an 8-byte MOVILINK<sup>®</sup> parameter channel during cyclical data exchange to perform the parameter services with DFP21B. The READ and WRITE services give the C1 master access to connected stations via the DP-V1 C1 channel.

Two additional C2 channels can be connected in parallel to these parameter channels. The first C2 master as a visualization device, for example could use these channels to read parameter data, and a second C2 master in the form of a notebook could use them to configure the drive using the MOVITOOLS<sup>®</sup> software.

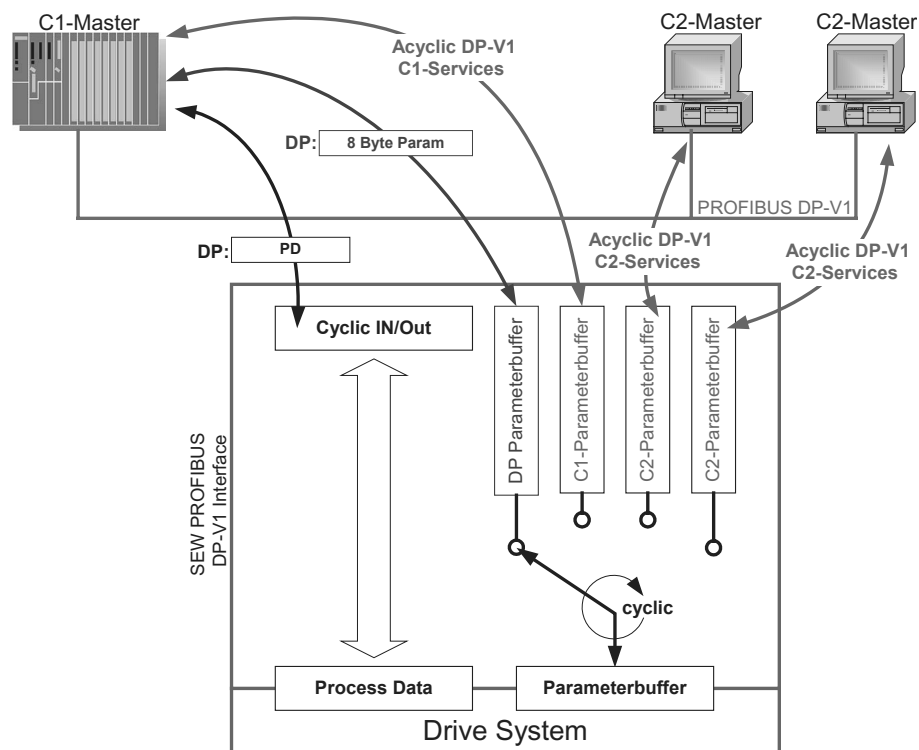

Figure 11: Parameter channels for PROFIBUS DP-V1

53124AXX



### 7.3 Structure of the DP-V1 parameter channel

Generally, the parameter setting of the drives to the PROFIdrive DP-V1 parameter channel of profile version 3.0 is implemented via data set 47. The *Request ID* entry is used to distinguish between parameter access based on PROFIdrive profile or via SEW-MOVILINK<sup>®</sup> services. The following table shows the possible codes of the individual elements. The data set structure is the same for PROFIdrive and MOVILINK<sup>®</sup> access.

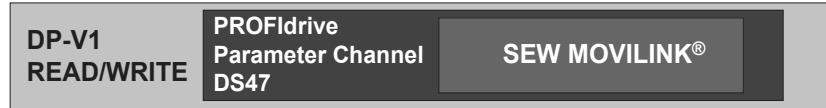

53125AXX

The following MOVILINK<sup>®</sup> services are supported:

- 8-byte MOVILINK<sup>®</sup> parameter channel with all the services supported by the drive inverter such as
  - READ parameter
  - WRITE parameter
  - WRITE parameter volatile
  - Etc.



The following PROFIdrive services are supported:

- Reading (request parameter) individual parameters of type *double word*
- Writing (change parameter) individual parameters of type *double word*

Table 1: Elements of data set DS47

Box	Data type	Values
Request reference	Unsigned8	0x00 Reserved 0x01 ... 0xFF
Request ID	Unsigned8	0x01 Request parameter (PROFIdrive) 0x02 Change parameter (PROFIdrive) 0x40 SEW MOVILINK® service
Response ID	Unsigned8	<u>Response (+):</u> 0x00 reserved 0x01 Request parameter (+) (PROFIdrive) 0x02 Change parameter (+) (PROFIdrive) <b>0x40 SEW-MOVILINK® service (+)</b>  <u>Response (-):</u> 0x81 Request parameter (-) (PROFIdrive) 0x82 Change parameter (-) (PROFIdrive) <b>0xC0 SEW-MOVILINK® service (-)</b>
Axis	Unsigned8	0x00 ... 0xFF Number of axes 0 ... 255
No. of parameters	Unsigned8	0x01 ... 0x13 1 ... 19 DWORDs (240 DP-V1 data bytes)
Attributes	Unsigned8	0x10 value  <b>For SEW MOVILINK® (request ID = 0x40):</b> <b>0x00 No service</b> <b>0x10 READ parameter</b> <b>0x20 WRITE parameter</b> <b>0x30 WRITE parameter volatile</b> <b>0x40 ... 0xF0 reserved</b>
No. of elements	Unsigned8	0x00 for parameters that are not indexed 0x01 ... 0x75 Quantity 1 ... 117
Parameter number	Unsigned16	0x0000 ... 0xFFFF MOVILINK parameter index
Subindex	Unsigned16	0x0000 SEW: Always 0
Format	Unsigned8	0x43 Double word 0x44 Error
No. of values	Unsigned8	0x00 ... 0xEA Quantity 0 ... 234
Error value	Unsigned16	0x0000 ... 0x0064 PROFIdrive error codes 0x0080 + MOVILINK® additional code low <b>For SEW MOVILINK® 16-bit error value</b>





7.3.1 Parameter setting procedure via data set 47

Parameter access is provided by the combination of the DP-V1 services *WRITE* and *READ*. The parameter setting service is transferred to the slave with *WRITE.req* followed by slave-internal processing.

The master now sends a *READ.req* to pick up the parameter setting response. The master repeats the *READ.req* if the *READ.res* from the slave is negative. As soon as the parameter processing in the drive inverter is concluded, it answers with a positive response *READ.res*. The user data now contain the parameter setting response of the parameter setting order that was previously sent with *WRITE.req* (see the following illustration). This mechanism applies to a C1 as well as a C2 master.

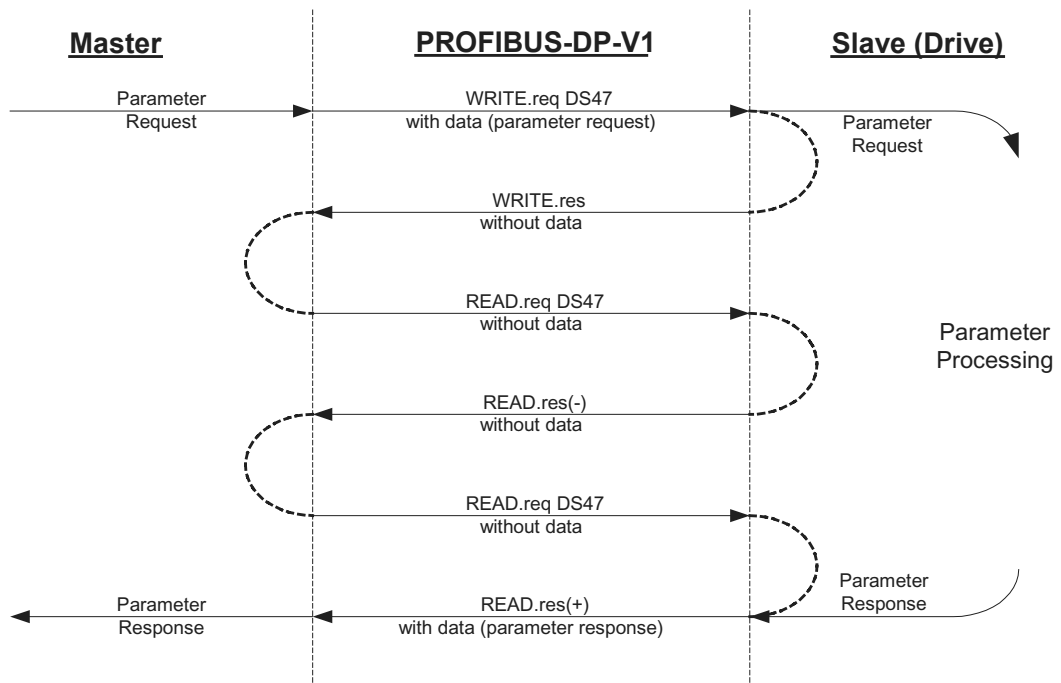

Figure 12: Telegram sequence for parameter access via PROFIBUSDP-V1

53126AXX



### 7.3.2 DP-V1 master processing sequence

If the bus cycles are very short, the request for the parameter response arrives before the inverter has concluded parameter access in the device. This means that the response data from the inverter is not yet available. In this case, the inverter sends a negative answer with the **Error\_Code\_1 = 0xB5 (status conflict)** to the DP-V1 level. The DP-V1 master must then send another request with the above-mentioned READ.req header until it receives a positive response from the drive inverter.

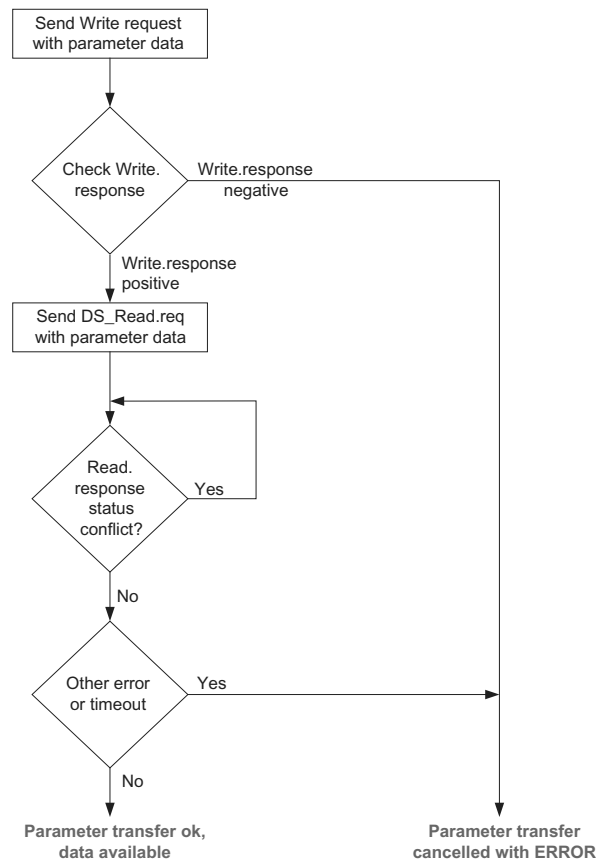

53127AEN



### 7.3.3 Addressing connected drive inverters

The structure of the DS47 data set defines an axis element. This element is used to reach multi-axis drives that are operated via one PROFIBUS interface. The axis element addresses one of the devices connected via the PROFIBUS interface. This mechanism can be used, for example, by the SEW MQP bus modules for MOVIMOT® or UFP for MOVITRAC® 07.

#### Addressing a MOVIDRIVE® inverter on the PROFIBUS DP-V1

With the setting *Axis = 0*, the parameter of the drive inverters can be accessed directly. Since there are no drive devices connected to the MOVIDRIVE®, access with *Axis > 0* is returned with an error code.

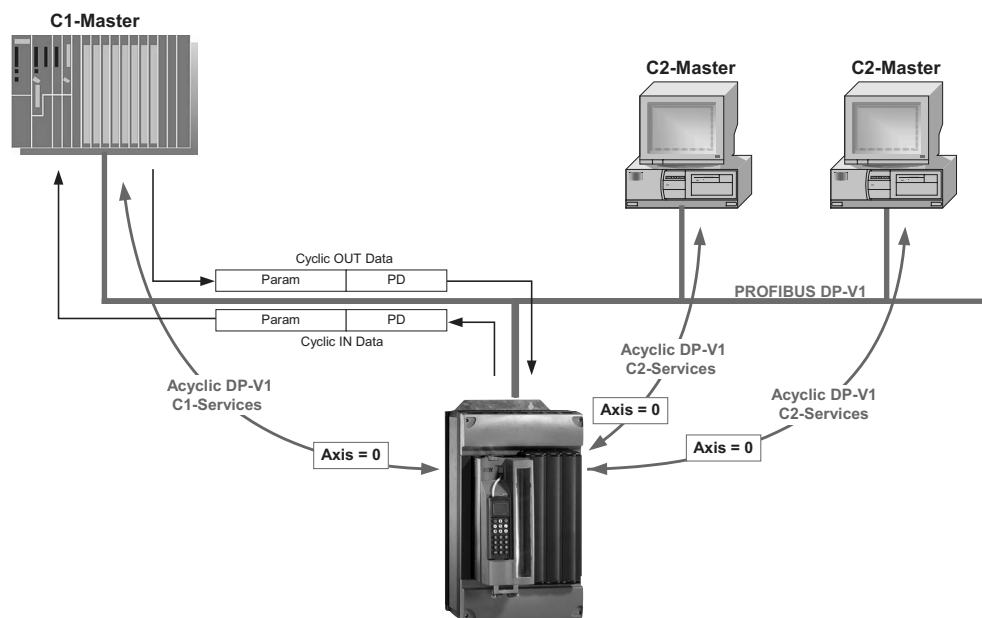

Figure 13: Addressing a MOVIDRIVE® directly via PROFIBUSDP-V1 with *Axis = 0*

53556AXX

### 7.3.4 MOVILINK® parameter requests

The MOVILINK® parameter channel of the SEW drive inverter is directly mapped in the structure of data set 47. The Request ID 0x40 (SEW MOVILINK® service) is used for the exchange of MOVILINK® parameter setting request. Parameter access with MOVILINK® services usually takes place according to the structure described below. The typical telegram sequence for data set 47 is used.

**Request-ID: 0x40 SEW-MOVILINK® service**

The actual service is defined by the data set element *Attribute* on the MOVILINK® parameter channel. The high nibble of this element corresponds to the service nibble in the management byte of the DP parameter channel.



**Example for reading a parameter via MOVILINK®**

The following tables show an example of the structure of the WRITE.request and READ.res user data for reading an individual parameter via the MOVILINK® parameter channel.

**Sending parameter request**

The table shows the coding of the user data for the WRITE.req service specifying the DP-V1 header. The WRITE.req service is used to transfer the parameter setting request to the drive inverter. The firmware version is read.

Table 2: WRITE.request header for transferring the parameter request

Service:	WRITE.request	Description
Slot_Number	0	Random, (is not evaluated)
Index	47	Index of the data set; constant index 47
Length	10	10 byte user data for parameter request

Table 3: WRITE.req USER DATA for MOVILINK® "READ parameter"

Byte	Field	Value	Description
0	Request reference	0x01	Individual reference number for the parameter setting request, mirrored in the parameter response
1	Request ID	0x40	SEW MOVILINK® service
2	Axis	0x00	Axis number; 0 = single axis
3	No. of parameters	0x01	1 parameter
4	Attributes	0x10	MOVILINK® service "READ parameter"
5	No. of elements	0x00	0 = access to direct value, no subelement
6, 7	Parameter number	0x206C	MOVILINK® index 8300 = "Firmware version"
8, 9	Subindex	0x0000	Subindex 0

**Query parameter response**

The following table shows the coding of the READ.req USER DATA including the DP-V1 header.

Table 4: READ.req for requesting the parameter response

Service:	READ.request	Description
Slot_Number	0	Random, (is not evaluated)
Index	47	Index of the data set; constant index 47
Length	240	Maximum length of response buffer in the DP-V1 master

**Positive MOVILINK® parameter response**

The table shows the READ.res USER DATA with the positive response data of the parameter setting request. For example, the parameter value for index 8300 (firmware version) is returned.

Table 5: DP-V1 header of the positive READ.response with parameter response

Service:	READ.request	Description
Slot_Number	0	Random, (is not evaluated)
Index	47	Index of the data set; constant index 47
Length	10	10 byte user data in response buffer



Table 6: Positive response for MOVILINK® service

Byte	Field	Value	Description
0	Response reference	0x01	Reflected reference number from the parameter setting request
1	Response ID	0x40	Positive MOVILINK® response
2	Axis	0x00	Reflected axis number; 0 = single axis
3	No. of parameters	0x01	1 parameter
4	Format	0x43	Parameter format: Double word
5	No. of values	0x01	1 value
6, 7	Value Hi	0x311C	Higher-order part of the parameter
8, 9	Value Lo	0x7289	Lower-order part of the parameter
			Decoding: 0x 311C 7289 = 823947913 dec >> Firmware version 823 947 9.13

**Example for writing a parameter via MOVILINK®**

As an example, the following tables show the structure of the *WRITE* and *READ* services for the volatile writing of the value 12345 to IPOS<sup>plus</sup>® variable H0 (parameter index 11000). The MOVILINK® service *WRITE parameter volatile* is used for this purpose.

**Send "WRITE parameter volatile" request**

Table 7: DP-V1 header of the *WRITE.request* with parameter request

Service:	WRITE.request	Description
Slot_Number	0	Random, (is not evaluated)
Index	47	Index of the data set; constant index 47
Length	16	16-byte user data for order buffer

Table 8: *WRITE.req* user data for MOVILINK® service "WRITE parameter volatile"

Byte	Field	Value	Description
0	Request reference	0x01	Individual reference number for the parameter setting request, mirrored in the parameter response
1	Request ID	0x40	SEW MOVILINK® service
2	Axis	0x00	Axis number; 0 = single axis
3	No. of parameters	0x01	1 parameter
4	Attributes	0x30	MOVILINK® service "WRITE parameter volatile"
5	No. of elements	0x00	0 = access to direct value, no subelement
6, 7	Parameter number	0x2AF8	Parameter index 11000 = "IPOS variable H0"
8, 9	Subindex	0x0000	Subindex 0
10	Format	0x43	Double word
11	No. of values	0x01	Change 1 parameter value
12, 13	Value HiWord	0x0000	Higher-order part of the parameter value
14, 15	Value LoWord	0x0BB8	Lower-order part of the parameter value

After sending this *WRITE.request*, the *WRITE.response* is received. If there was no status conflict in processing of the parameter channel, a positive *WRITE.response* results. Otherwise, the status fault is located in *Error\_code\_1*.

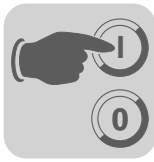

#### Query parameter response

The following table shows the coding of the WRITE.req USER DATA including the DP-V1 header.

Table 9: READ.req for requesting the parameter response

Field	Value	Description
Function_Num		READ.req
Slot_Number	X	Slot_Number not used
Index	47	Index of the data set
Length	240	Maximum length of response buffer in the DP master

#### Positive response to "WRITE Parameter volatile"

Table 10: DP-V1 header of the positive READ.response with parameter response

Service:	READ.response	Description
Slot_Number	0	Random, (is not evaluated)
Index	47	Index of the data set; constant index 47
Length	4	4-byte user data in response buffer

Table 11: Positive response for MOVILINK® service "WRITE parameter"

Byte	Field	Value	Description
0	Response reference	0x01	Reflected reference number from the parameter setting request
1	Response ID	0x40	Positive MOVILINK® response
2	Axis	0x00	Reflected axis number; 0 = single axis
3	No. of parameters	0x01	1 parameter

#### Negative parameter response

The following table shows the coding of a negative response of a MOVILINK® service. Bit 7 is entered in the response ID if the response is negative.

Table 12: Negative response for MOVILINK® service

Service:	READ.response	Description
Slot_Number	0	Random, (is not evaluated)
Index	47	Index of the data set; constant index 47
Length	8	8-byte user data in response buffer

Byte	Field	Value	Description
0	Response reference	0x01	Reflected reference number from the parameter setting request
1	Response ID	0xC0	Negative MOVILINK® response
2	Axis	0x00	Reflected axis number; 0 = single axis
3	No. of parameters	0x01	1 parameter
4	Format	0x44	Error
5	No. of values	0x01	1 error code
6, 7	Error value	0x0811	MOVILINK® return code e.g. Error class 0x08, Add. code 0x11 (see section "MOVILINK® return code of the parameter settings for DP-V1" on page page 71)



**MOVILINK parameter setting return codes for DP-V1**

The following table shows the return codes that are returned by the SEW DP-V1 interface if an error occurs during DP-V1 parameter access.

MOVILINK Return codes (hex)	Description
0x0810	Invalid index, parameter index does not exist in the unit
0x0811	Function/parameter not implemented
0x0812	Read access only
0x0813	Parameter lock active
0x0814	Factory setting is active
0x0815	Value for parameter too large
0x0816	Value for parameter too small
0x0817	Required option card not installed
0x0818	Error in system software
0x0819	Parameter access via RS-485 process interface only
0x081A	Parameter access via RS-485 diagnostic interface only
0x081B	Parameter is access-protected
0x081C	Control inhibit is required
0x081D	Invalid value for parameter
0x081E	Factory setting was activated
0x081F	Parameter was not saved in EEPROM
0x0820	Parameter cannot be changed with output stage enabled / reserved
0x0821	Reserved
0x0822	Reserved
0x0823	Parameter may be changed at IPOS program stop only
0x0824	Parameter may only be changed Autosetup is deactivated
0x0505	Incorrect coding of management and reserved byte
0x0602	Communication error between inverter system and fieldbus option card
0x0502	Timeout of secondary connection (such as during reset or with Sys-Fault)



#### 7.3.5 PROFdrive parameter requests

The PROFdrive parameter channel of SEW drive inverters is directly mapped in the structure of data set 47. Parameter access with PROFdrive services usually takes place according to the structure described below. The typical telegram sequence for data set 47 is used. PROFdrive only defines the following two request IDs:

**Request ID:0x01Request parameter (PROFdrive)**

**Request ID:0x02Change parameter (PROFdrive)**

This means that there is restricted data access in comparison with the MOVILINK<sup>®</sup> services.



The request ID = 0x02 = Change parameter (PROFdrive) results in remanent write access to the selected parameter. Consequently, the internal flash/EEPROM of the inverter is written with each write access. Use the MOVILINK<sup>®</sup> service "WRITE Parameter volatile" if parameters must be written cyclically at short intervals. With this service, you only alter the parameter values in the RAM of the inverter.

**Example for reading a parameter according to PROFdrive**

The following tables show an example of the structure of the WRITE.request and READ.resuser data for reading an individual parameter via the MOVILINK<sup>®</sup> parameter channel.

#### Sending parameter request

The table shows the coding of the user data for the WRITE.reqservice specifying the DP-V1 header. The WRITE.req service is used to transfer the parameter setting request to the drive inverter.

Table 13: WRITE.request header for transferring the parameter request

Service:	WRITE.request	Description
Slot_Number	0	Random, (is not evaluated)
Index	47	Index of the data set; constant index 47
Length	10	10-byte user data for parameter request

Table 14: WRITE.req USER DATA for PROFdrive "Request parameter"

Byte	Field	Value	Description
0	Request reference	0x01	Individual reference number for the parameter setting request, mirrored in the parameter response
1	Request ID	0x01	Request parameter (PROFdrive)
2	Axis	0x00	Axis number; 0 = single axis
3	No. of parameters	0x01	1 parameter
4	Attributes	0x10	Access to parameter value
5	No. of elements	0x00	0 = access to direct value, no subelement
6, 7	Parameter number	0x206C	MOVILINK <sup>®</sup> index 8300 = "Firmware version"
8, 9	Subindex	0x0000	Subindex 0





### Query parameter response

The following table shows the coding of the READ.req USER DATA including the DP-V1 header.

Table 15: READ.req for requesting the parameter response

Service:	READ.request	Description
Slot_Number	0	Random, (is not evaluated)
Index	47	Index of the data set; constant index 47
Length	240	Maximum length of response buffer in the DP-V1 master

### Positive PROFIdrive parameter response

The table shows the READ.res user data with the positive response data of the parameter setting request. For example, the parameter value for index 8300 (firmware version) is returned.

Table 16: DP-V1 header of the positive READ.response with parameter response

Service:	READ.request	Description
Slot_Number	0	Random, (is not evaluated)
Index	47	Index of the data set; constant index 47
Length	10	10-byte user data in response buffer

Table 17: Positive response for MOVILINK® service

Byte	Field	Value	Description
0	Response reference	0x01	Reflected reference number from the parameter setting request
1	Response ID	0x01	Positive response for "Request Parameter"
2	Axis	0x00	Reflected axis number; 0 = single axis
3	No. of parameters	0x01	1 parameter
4	Format	0x43	Parameter format: Double word
5	No. of values	0x01	1 value
6, 7	Value Hi	0x311C	Higher-order part of the parameter
8, 9	Value Lo	0x7289	Lower-order part of the parameter
			Decoding: 0x 311C 7289 = 823947913 dec >> firmware version 823 947 9.13



**Example for writing a parameter according to PROFdrive**

The following tables show an example of the structure of the *WRITE* and *READ* services for the **remanent** writing of the internal setpoint n11 (see section "Example for writing a parameter via MOVILINK®" on page 69). The PROFdrive service *Change parameter* is used for this purpose.

**Send "WRITE parameter" request**

Table 18: DP-V1 header of the *WRITE.request* with parameter request

Service:	WRITE.request	Description
Slot_Number	0	Random, (is not evaluated)
Index	47	Index of the data set; constant index 47
Length	16	16-byte user data for order buffer

Table 19: *WRITE.req* user data for PROFdrive service "Change parameter"

Byte	Field	Value	Description
0	Request reference	0x01	Individual reference number for the parameter setting request, mirrored in the parameter response
1	Request ID	0x02	Change parameter (PROFdrive)
2	Axis	0x01	Axis number; 0 = single axis
3	No. of parameters	0x01	1 parameter
4	Attributes	0x10	Access to parameter value
5	No. of elements	0x00	0 = access to direct value, no subelement
6, 7	Parameter number	0x7129	Parameter index 8489 = P160 n11
8, 9	Subindex	0x0000	Subindex 0
10	Format	0x43	Double word
11	No. of values	0x01	Change 1 parameter value
12, 13	Value HiWord	0x0000	Higher-order part of the parameter value
14, 15	Value LoWord	0x0BB8	Lower-order part of the parameter value

After sending this *WRITE.request*, the *WRITE.response* is received. If there was no status conflict in processing of the parameter channel, a positive *WRITE.response* results. Otherwise, the status fault is located in `Error_code_1`.

**Query parameter response**

The following table shows the coding of the *WRITE.req* user data including the DP-V1 header.

Table 20: *READ.req* for requesting the parameter response

Field	Value	Description
Function_Num		READ.req
Slot_Number	X	Slot_Number not used
Index	47	Index of the data set
Length	240	Maximum length of response buffer in the DP-V1 master



**Positive response to "WRITE parameter"**

Table 21: DP-V1 header of the positive READ.response with parameter response

Service:	READ.response	Description
Slot_Number	0	Random, (is not evaluated)
Index	47	Index of the data set; constant index 47
Length	4	4-byte user data in response buffer

Table 22: Positive response for PROFIdrive service "Change parameter"

Byte	Field	Value	Description
0	Response reference	0x01	Reflected reference number from the parameter setting request
1	Response ID	0x02	Positive PROFIdrive response
2	Axis	0x01	Reflected axis number; 0 = single axis
3	No. of parameters	0x01	1 parameter

**Negative parameter response**

The following table shows the coding of a negative response of a PROFIdrive service. Bit 7 is entered in the response ID if the response is negative.

Table 23: Negative response for PROFIdrive service

Service:	READ.response	Description
Slot_Number	0	Random, (is not evaluated)
Index	47	Index of the data set; constant index 47
Length	8	8-byte user data in response buffer

Byte	Field	Value	Description
0	Response reference	0x01	Reflected reference number from the parameter setting request
1	Response ID	0x810x82	Negative response for "Request parameter," negative response for "Change Parameter"
2	Axis	0x00	Reflected axis number; 0 = single axis
3	No. of parameters	0x01	1 parameter
4	Format	0x44	Error
5	No. of values	0x01	1 error code
6, 7	Error value	0x0811	MOVILINK® return code e.g. Error class 0x08, Add. code 0x11 (see section "MOVILINK® return codes for DP-V1" on page 71)



#### PROFdrive return codes for DP-V1

This table shows the coding of the error number in the PROFdrive DP-V1 parameter response according to PROFdrive profile V3.1. This table applies if you use the PROFdrive services "Request parameter" and/or "Change parameter".

Error no.	Meaning	Used for
0x00	Invalid parameter number.	Access to non-existent parameters
0x01	Parameter value cannot be changed	An attempt was made to change a parameter value that cannot be changed
0x02	Minimum or maximum value exceeded	An attempt was made to change a value to one that is outside of the limit values
0x03	Incorrect subindex	Access to non-existent subindex
0x04	No assignment	Access with subindex to parameter that is not indexed
0x05	Incorrect data type	An attempt was made to change a replace a value with one that does not correspond to the data type of the parameter
0x06	Setting not permitted (can only be reset)	An attempt was made to set a value to one larger than 0 where this is not permitted
0x07	Description element cannot be changed	Access to description element that cannot be changed
0x08	Reserved	(PROFdrive profile V2: PPO write query for IR not available)
0x09	Description does not exist	Access to description that is not accessible (parameter value is exists)
0x0A	Reserved	(PROFdrive profile V2: incorrect access group)
0x0B	No operation priority	An attempt was made to change a parameter without change rights
0x0C	Reserved	(PROFdrive profile V2: incorrect password)
0x0D	Reserved	(PROFdrive profile V2: text cannot be read in cyclic data transfer)
0x0E	Reserved	(PROFdrive profile V2: name cannot be read in cyclic data transfer)
0x0F	No text assignment available	Access to text assignment that is not accessible (parameter value exists)
0x10	Reserved	(PROFdrive profile V2: no PPO write)
0x11	Request cannot be executed due to the operating mode	Access is currently not possible and the reason is not explained
0x12	Reserved	(PROFdrive profile V2: other error)
0x13	Reserved	(PROFdrive profile V2: data cannot be read in cyclic exchange)
0x14	Incorrect value	An attempt was made to change a value to one that is in the permitted range but is not permitted due to other long-term reasons (parameter with specified individual values)
0x15	Response is too long	The length of the current response exceeds the maximum transmittable length
0x16	Invalid parameter address	Invalid value or value that is not valid for this attribute, number of elements, parameter number, subindex or a combination of these factors.
0x17	Incorrect format	Write request: Invalid format or parameter data format that is not supported
0x18	Number of values is not consistent	Write request: Number of values of parameter data does not correspond to the number of elements in the parameter address
0x19	Axis does not exist	Access to an axis that does not exist
up to 0x64	Reserved	–
0x65..0xFF	Depends on the manufacturer	–



## **7.4 Project planning for a C1 master**

A special GSD file *SEWA6003.GSD* is required for the project planning of a DP-V1 C1 master. This file activates the DP-V1 functions of the DFP21B. Therefore, the functions of the GSD file and the DFP21B firmware must correspond with one another. When you implement the DP-V1 functions, SEW-EURODRIVE provides you with two GSD files (see section 5.2.1 on page 26, section 5.2.2 on page 27 and section 5.3.1 on page 34).

### **7.4.1 Operating mode (DP-V1 mode)**

The DP-V1 operating mode can usually be activated during project planning for a C1 master. All DP slaves that have the DP-V1 functions enabled in their GSD files and that support DP-V1 will then be operated in the DP-V1 mode. Standard DP slaves will still run via PROFIBUS DP. This ensures mixed mode is run for DP-V1 and DP-capable modules. Depending on the specification of the master functionality, a DP-V1-capable station that was configured using the DP-V1 GSD file, can run in the "DP" operating mode.



#### 7.4.2 Example program for SIMATIC S7

The STEP7 code stored in the GSD file shows how parameters are accessed via the STEP7 system function modules SFB 52/53. You can copy the STEP7 code and import/compile it as a STEP7 source.



This example is a special and free service that demonstrates only the basic approach to generating a PLC program without commitment. We are not liable for the contents of the program example.

#### Example: Function module FB5 "DPV1\_Movilink\_FB"

```

FUNCTION_BLOCK FB 5
TITLE =DPV1_Movilink_FB
//NOTE!
//This example program only shows the basics procedure.
//Neither legal nor any kind of liability can be inferred from faulty program functions and the consequences
thereof.

//System requirements:
// - DP master interface module of series S7-300 or S7-400 that support DPV1 master functions.
// - DPV1 Profibus connections from SEW (identifier "SEWA600x.GSD")

//This function module performs the parameter exchange between the inverter and the PLC via the DPV1 channel. As
data exchange via the DPV1 parameter channel is an acyclic service, the function module must be called up until
the data exchange is complete (duration starting when a parameter request is triggered via fActivate until check-
back from fDone).

AUTHOR : SEW
FAMILY : Movilink
VERSION : 0.1

VAR_INPUT
  Drive_IO_Address : INT ; //Periphery address of the inverter
  bService : BYTE ; //Movilink service byte 0x01 = READ, 0x02 = WRITE, etc.
  bAxis : BYTE ; //0 for single axis, subaddress of the axis when using UFP11A
  wParameterIndex : WORD ; //Movilink parameter index
  wSubIndex : WORD ; //Movilink subindex
  dwWRITEData : DWORD ; //WRITEData
  InstanzDB_SFB52 : BLOCK_DB ; //InstanzDB of the system function SFB52. Required for DPV1_READ
  InstanzDB_SFB53 : BLOCK_DB ; //InstanzDB of the system function SFB53. Required for DPV1_WRITE
END_VAR

VAR_OUTPUT
  bError : BYTE ; //No error = 0, S7 error = 1, timeout = 2, Movilink error = 3;
  dwData : DWORD ; //Contains data if fError=0; S7 error code if fError=1; otherwise undef.
END_VAR

VAR_IN_OUT
  fActivate : BOOL ; //Triggering the function
  fBusy : BOOL ; //Busy bit. TRUE until the function is finished or timeout monitoring responds
  fDone : BOOL ; //Indicates that the function is finished (with or without error)
END_VAR

VAR
  fStaticBusy : BOOL ; //Storage bit for busy flag
  fStaticWRITEReq : BOOL ; //When MVLK WRITEReq = TRUE or MVLK READReq = FALSE
  fDPV1WRITEDone : BOOL ; //Indicates whether DPV1 WRITE was performed
  fAuxflag : BOOL ;
  dwStaticDriveAddr : DWORD ; //I/O address of the inverter
  iStaticReqLength : INT ; //Length of the telegrams to be transmitted
  MVLK_Req : STRUCT //MovilinkStruktur WRITERequest
    RequestReference : BYTE := B#16#1; //REQ: Request Reference
    RequestId : BYTE := B#16#40; //REQ: Request ID
    Axis : BYTE ; //REQ: Axis
    No_of_Parameter : BYTE := B#16#1; //REQ: No of Parameters
    Attribute : BYTE ; //REQ: Attribute
    No_of_Elements : BYTE ; //REQ: No of Elements
    ParameterNumber : WORD ; //REQ: Parameternumber
    Subindex : WORD ; //REQ: Subindex
    Format : BYTE := B#16#43;
    Values : BYTE := B#16#1;
    WRITEData : DWORD ; //REQ: WRITEData
  END_STRUCT ;
  TimeoutCounter : WORD ; //Timeout counter
END_VAR

```

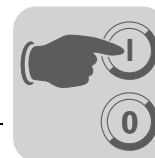

```

VAR_TEMP
MVLK_Resp : STRUCT //Movilink structure response
  ResponseReference : BYTE ; //RESP: Response reference
  ResponseId : BYTE ; //RESP: Response ID
  Axis : BYTE ; //RESP: Axis
  No_of_Parameter : BYTE ; //RESP: No of Parameters
  Attachment : ARRAY [ 0 .. 7 ] OF //REQ: Data
  BYTE ;
END_STRUCT ;
fTempError : BOOL ;
fTempBusy : BOOL ;
fTempDone : BOOL ;
fTempValid : BOOL ;
dwTempStatus : DWORD ;
END_VAR

BEGIN
NETWORK
TITLE =Insert transfer parameter in Movilink structure

U #fActivate;
FP #fAuxflag; //If neither a parameter service is triggered
O #fBusy; //...nor processed,
SPBN END; //...then the function is ended
U #fStaticBusy; //If static busy is set, WRITE service has already been performed,
SPBN NEWR; //then go to new request
U #fDPV1WRITEDone; //If WRITE service was finished without error, go to READ
SPB READ;
SPA WRIT; //Else go to WRITE
NEWR: NOP 0; //Initialization:
UN #fStaticBusy; //Output bits and values are reset
S #fStaticBusy; //Busy output and flag bit are set
S #fBusy;
R #fDone; //DoneBit will be reset
L 0;
T #bError; //Error and data output values are set to ZERO
T #dwData;
L #Drive_IO_Address; //Convert drive address from Int to DWord
T #dwStaticDriveAddr;

//Bring data into Movilink structure (only the variable values of the structure are supplied with the input parameters here)
L #bAxis;
T #MVLK_Req.Axis;
L #bService; //Service byte is multiplied by 10 hex
SLW 4;
T #MVLK_Req.Attribute;
L #bService;
SPL ERUI; //Go to MVLK service error
SPA ERUI; // 0x00 No Service
SPA ZEHN; // 0x01 READ Parameter
SPA SEXZ; // 0x02 WRITE Parameter
SPA SEXZ; // 0x03 WRITE Parameter volatile
SPA ZEHN; // 0x04 READ Min
SPA ZEHN; // 0x05 READ Max
SPA ZEHN; // 0x06 READ Default
SPA ZEHN; // 0x07 READ Scale
SPA ZEHN; // 0x08 READ Attribute
SPA ZEHN; // 0x09 READ EEPROM

ERUI: NOP 0; // Illegal MVLK service error
L 3; //Movilink error
T #bError;
L DW#16#501; //MLER_ILLEGAL_SERVICE
SET ;
S #fDone; //Busy and done bits are reset
R #fBusy;
R #fStaticBusy;
R #fDPV1WRITEDone;
BEA ; //End function

SEXZ: NOP 0;
SET ;
S #fStaticWRITEReq; //Indicates whether the request was a MVLK WRITE request for data evaluation
L 16;
SPA LEN; //Go to defined length

ZEHN: NOP 0;
SET ;
R #fStaticWRITEReq; //Indicates whether the request was a MVLK READ request for data evaluation
L 10;

LEN: NOP 0;
T #iStaticReqLength;
L #wParameterIndex;
T #MVLK_Req.ParameterNumber;
L #wSubIndex;
T #MVLK_Req.Subindex;
L #dwWRITEData; //Data is written to the structure, no matter whether write or read access
T #MVLK_Req.WRITEData;

```



```

NETWORK
TITLE =WRITEDienst
//To transfer the parameter requirement to the inverter, an SFB53 call
//(DPV1WRITE service) must be executed.
WRIT: NOP 0;
      CALL SFB 53 , #InstanzDB_SFB53 (
          REQ           := TRUE,
          ID            := #dwStaticDriveAddr,
          INDEX        := 47, //Data set 47
          LEN          := #iStaticReqLength,
          DONE         := #fTempDone,
          BUSY         := #fTempBusy,
          ERROR        := #fTempError,
          STATUS       := #dwTempStatus,
          RECORD       := #MVLK_Req);

//Evaluation of return values
U      #fTempBusy; //The FB is exited and the busy bit set if the function is not finished.
SPB   ENDB;
U      #fTempError; //If no error has occurred, go to read preparation.
SPBN  RD_V;
SET   ; //An error has occurred. Set error bit and reset busy bits
R     #fBusy;
R     #fStaticBusy;
R     #fDPV1WRITEDone;
S     #fDone;
L     1; //Issue error code 1 (S7 error)
T     #bError;
L     #dwTempStatus; //Return the S7 error code
T     #dwData;
RD_V: NOP 0; //DPV1 read service preparation
      SET   ;
      S     #fDPV1WRITEDone;

NETWORK
TITLE =READDienst
//To fetch the parameter response from the inverter, a SFB52 call
//(DPV1READ service) must be executed.
READ: NOP 0;
      CALL SFB 52 , #InstanzDB_SFB52 (
          REQ           := TRUE,
          ID            := #dwStaticDriveAddr,
          INDEX        := 47, //Data set 47
          MLEN         := 12,
          VALID        := #fTempValid,
          BUSY         := #fTempBusy,
          ERROR        := #fTempError,
          STATUS       := #dwTempStatus,
          LEN          := #iStaticReqLength,
          RECORD       := #MVLK_Resp);

//Evaluation of return values
U      #fTempBusy; //The FB is exited and the busy bit set if the function is not finished.
SPB   ENDB;
U      #fTempError; //If no error has occurred, go to data evaluation.
SPBN  DATA;
L     #TimeoutCounter; //Timeout counter is increased
L     1;
+I    ;
T     #TimeoutCounter;
L     #TimeoutCounter; //A timeout error is triggered when the timeout counter has reached 300
L     300;
>=I  ;
SPB  TOUT;
//If error xx80B5xx hex (state conflict) is reported, then another parameter order already exists and the read
operation must be repeated
L     #dwTempStatus;
UD    DW#16#FFFF00;
L     DW#16#80B500;
=D    ;
SPBN  ERR;
NOP  0;
SPA  ENDB;

ERR: SET   ; //An error has occurred. Set error bit and reset busy bits
      R     #fBusy;
      R     #fStaticBusy;
      R     #fDPV1WRITEDone;
      S     #fDone;
      L     1; //Issue error code 1 (S7 error)
      T     #bError;
      L     #dwTempStatus; //Return the S7 error code
      T     #dwData;
      L     0;
      T     #TimeoutCounter; //Reset timeout counter
      BEA  ;

```



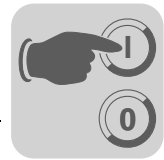

```

DATA: NOP 0; //Data evaluation (first selection; positive or negative response)
L #MVLK_Resp.ResponseId;
L B#16#40; //positive Movilink response?
==I
;
SPB POSR; //go to positive response
L #MVLK_Resp.ResponseId;
L B#16#C0; //negative Movilink response?
==I
;
SPB NEGR; //go to negative response
SET ; //illegal Movilink response
S #fDone;
R #fBusy;
R #fStaticBusy;
R #fDPV1WRITEDone;
L 3; //Movilink error
T #bError;
L DW#16#502; //MLER_NO_RESPONSE
T #dwData;
L 0;
T #TimeoutCounter; //Reset timeout counter
BEA ; //End function

TOUT: NOP 0; //Timeout
L 2; //Movilink error
T #bError;
L 0;
T #dwData;
T #TimeoutCounter; //Reset timeout counter
SET ; //The function is finished:
S #fDone; //=> set Done, reset ..Busy
R #fActivate;
R #fBusy;
R #fStaticBusy;
R #fDPV1WRITEDone;
BEA ;

NETWORK
TITLE =Auswertung der Parameterdaten

POSR: NOP 0;
U #fStaticWRITEReq;
SPB WRR; //go to WRITERequestResponse
// //READRequest was performed
L #MVLK_Resp.Attachment[2]; //Received data is written into output parameter.
SLD 24;
L #MVLK_Resp.Attachment[3];
SLD 16;
+D
;
L #MVLK_Resp.Attachment[4];
SLD 8;
+D
;
L #MVLK_Resp.Attachment[5];
+D
;
T #dwData;
L 0; //kein Fehler
T #bError;
SET ; //The function is finished:
S #fDone; //=> set Done, reset fActivate, ...
R #fActivate;
R #fBusy;
R #fStaticBusy;
R #fDPV1WRITEDone;
L 0;
T #TimeoutCounter; //Reset timeout counter
BEA ;

WRR: NOP 0;
// //WRITERequest was performed
L 0; //Output parameter is filled with ZEROS
T #dwData;
L 0; //No error
T #bError;
SET ; //Clear error bits
S #fDone;
R #fActivate;
R #fBusy;
R #fStaticBusy;
R #fDPV1WRITEDone;
L 0;
T #TimeoutCounter; //Reset timeout counter
BEA ;

```



```

NEGR: NOP    0;
      L      3; //Movilink error
      T      #bError;
      L      #MVLK_Resp.Attachment[2]; //Write error code to output parameter
      SLW    8;
      L      #MVLK_Resp.Attachment[3];
      +I     ;
      T      #dwData;
      SET    ; //The function is finished:
      S      #fDone; //=> set Done, reset ..Busy
      R      #fActivate;
      R      #fBusy;
      R      #fStaticBusy;
      R      #fDPV1WRITEDone;
      L      0;
      T      #TimeoutCounter; //Reset timeout counter
      BEA    ;

ENDB: SET    ; //Busy end
      S      #fBusy;
END:  NOP    0;
END_FUNCTION_BLOCK

```

### Example for calling FB5 "DPV1\_Movilink\_FB"

Insert these lines into your cyclical S7 program to call the function module.

```

FUNCTION FC 1 : VOID
TITLE =Operation of the _DPV1 parameter channel
//This example program only shows the basics procedure.
//Neither legal nor any kind of liability can be inferred from faulty program functions and the consequences
thereof.

VERSION : 0.1

BEGIN
NETWORK
TITLE =Writing an MC07 parameter
//In this example, the internal setpoint n11 (P160) is written volatile with the value 123 rpm. The parameter
service can be triggered by a positive edge at M100.0 (variable table "MC07").

//The parameter service addresses the MC07 with SBUS address 2.
//
//PROFIBUS addr. 9
//Per. addr. 512
//
//      I          UFP11A          MC07_1          MC07_2
//      I          I          I          I
//      SBUS addr.0  SBUS addr.1  SBUS addr. 2
//
//
//Note on the hardware configuration:
//The peripheral addresses ("PEW address" and "PAW address") of the UFP11A must have the same numerical value so
that the input "Drive_IO_Address" can be clearly defined.

//
//
L      L#123000; //Convert the parameter value from DINT..
T      MD 110; //... to DWORD
//Conversion factor/value range of the parameter value: see parameter list in the "MC07 Communication" manual

CALL FB 5 , DB 5 (
      Drive_IO_Address      := 512,
      bService              := B#16#3, //0x01 = read, 0x02 = write, 0x03 = write volatile
      bAxis                 := B#16#2, //MC07 with SBUS addr. 2
      wParameterIndex       := W#16#2129, //MOVILINK parameter index 8489d = P160, internal setpoint n11
      wSubIndex             := W#16#0, //MOVILINK subindex = 0
      dwWRITEData           := MD 110, //Parameter value that is being written
      InstanzDB_SFB52       := DB 201, //Instance-DB for SFB52 is required for DPV1_READ
      InstanzDB_SFB53       := DB 202, //Instance-DB for SFB53 is required for DPV1_WRITE
      bError                := MB 118, //No error = 0; S7 error = 1, timeout = 2, MOVILINK error = 3;
      dwData                := MD 114, //bError = 0 => parameter value that was read; bError = 1 => S7
error code
      fActivate              := M 100.0, //Activation bit: Triggering a parameter request
      fBusy                  := M 100.1, //The parameter request is being processed or a timeout has
occurred
      fDone                  := M 100.2; //The parameter request is finished

END_FUNCTION

```



### 7.4.3 DP-V1 technical data for MOVIDRIVE® DFP21

<b>GSD file for DP-V1:</b>	<b>SEWA6003.GSD</b>
Module name for project planning:	MOVIDRIVE® DFP21B/MCH (DP-V1)
Number of parallel C2 connections:	2
Supported data set:	Index 47
Supported slot number:	Recommended: 0
Manufacturer code:	10A hex (SEW-EURODRIVE)
Profile ID:	0
C2 response timeout	1s
Max. length C1 channel:	240 bytes
Max. length C2 channel:	240 bytes

### 7.4.4 Technical data DP-V1 for the gateway operation and MOVITRAC®

<b>GSD file for DP-V1:</b>	<b>SEW6009.GSD</b>
Module name for project planning:	DFP21B gateway
Number of parallel C2 connections:	2
Supported data set:	Index 47
Supported slot number:	Recommended: 0
Manufacturer code:	10A hex (SEW-EURODRIVE)
Profile ID:	0
C2 response timeout	1 s
Max. length C1 channel:	240 bytes
Max. length C2 channel:	240 bytes



#### 7.4.5 Error codes of the DP-V1 services

This table shows possible error codes of DP-V1 services that may occur in the event of an error in the communication on DP-V1 telegram level. This table is relevant if you want to write your own parameter assignment block based on the DP-V1 services because the error codes are reported directly back on the telegram level.

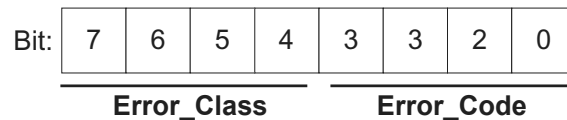

Error_Class (from DP-V1-Specification)	Error_Code (from DP-V1-Specification)	DP-V1 Parameter channel
0x0 ... 0x9 hex = reserved		
0xA = application	0x0 = read error 0x1 = write error 0x2 = module failure 0x3 to 0x7 = reserved 0x8 = version conflict 0x9 = feature not supported 0xA to 0xF = user specific	
0xB = access	0x0 = invalid index	0xB0 = No data block Index 47 (DB47); parameter requests are not supported
	0x1 = write length error 0x2 = invalid slot 0x3 = type conflict 0x4 = invalid area	
	0x5 = state conflict	0xB5 = Access to DB 47 temporarily not possible due to internal processing status
	0x6 = access denied	
	0x7 = invalid range	0xB7 = WRITE DB 47 with error in the DB 47 header
	0x8 = invalid parameter 0x9 = invalid type 0xA to 0xF = user specific	
0xC = resource	0x0 = read constraint conflict 0x1 = write constraint conflict 0x2 = resource busy 0x3 = resource unavailable 0x4..0x7 = reserved 0x8..0xF = user specific	
0xD...0xF = user specific		



## 8 Operation of MOVITOOLS® MotionStudio via PROFIBUS

This section describes the operation of the MOVITOOLS® MotionStudio via PROFIBUS.

### 8.1 Introduction

PROFIBUS DP-V1 provides the user with acyclical parameter services in addition to cyclical process data. These acyclic parameter services can be used by the control system (class 1 or C1 master) as well as by other diagnostics and visualization devices (class 2 or C2 master).

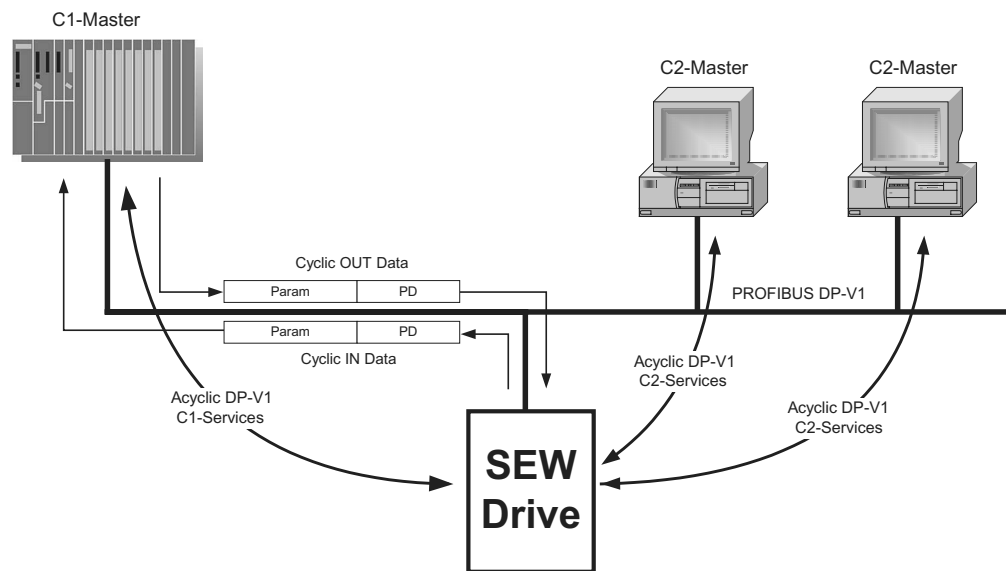

58617AXX

"MOVITOOLS® via PROFIBUS DP-V1" makes use of the features of the C2 master.

There are two configuration variants:

Access via Softnet-DP driver	The Softnet-DP driver from Siemens is installed on the diagnostics PC. A connection to the drive can then be established by means of acyclical C2 services and MOVITOOLS® MotionStudio can be used online. This configuration variant is independent of the C1 master. For example, a connection can even be established if the C1 master has failed. See section 8.5 for a description of how to configure the SIMATIC Net.
Access via STEP7	A PG/PC PROFIBUS connection is configured and transferred to the programmable controller in NetPro / SIMATIC STEP7. If STEP7 version 5.3 SP3 is installed on your PC, the Softnet driver need not be installed on the diagnostics PC.



### 8.2 Required hardware

Siemens PROFIBUS master card (CP5512, CP5611)

6GK1561-1AA00	SIMATIC NET CP5611 PCI card	PCI card for PCs
6GK1551-2AA00	SIMATIC NET CP5512 PCMCIA card	PCMCIA card for notebook 32-bit cardbus

### 8.3 Required software

- STEP7 version 5.3, SP3
- **or**
- Siemens Softnet DP PC driver for PROFIBUSDP, version 6.0 or higher

6GK1704-5DW61-3AA0	SIMATIC NET PB Softnet DP 6.1	Driver package for WinNT 4.0, Win2k
--------------------	-------------------------------	-------------------------------------

- MOVITOOLS® MotionStudio, version 5.20 or higher

### 8.4 Installation

- Install the PROFIBUS master card into the diagnostics PC and install the driver according to the manufacturers specifications.
- Install the MOVITOOLS® MotionStudio.



## 8.5 Configuring SIMATIC NET

- Start the program "Set PG-PC interface" from the start menu [SIMATIC]/[SIMATIC NET]/[Settings] or from the Windows system control.
- Set the access path of the application as displayed in the following image:

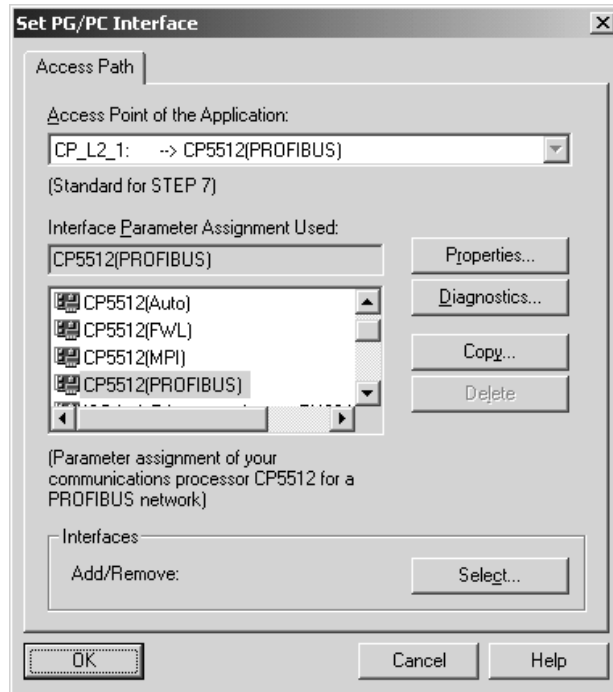

11307AEN

Figure 14: Setting the PG/PC interface



If SIMATIC STEP7 is installed on the computer and is started there from the program "Set PG-PC interface", the field for the access path is deactivated. Start the program via the start menu as described above.



- Press the "Properties" button. The following dialog box opens:

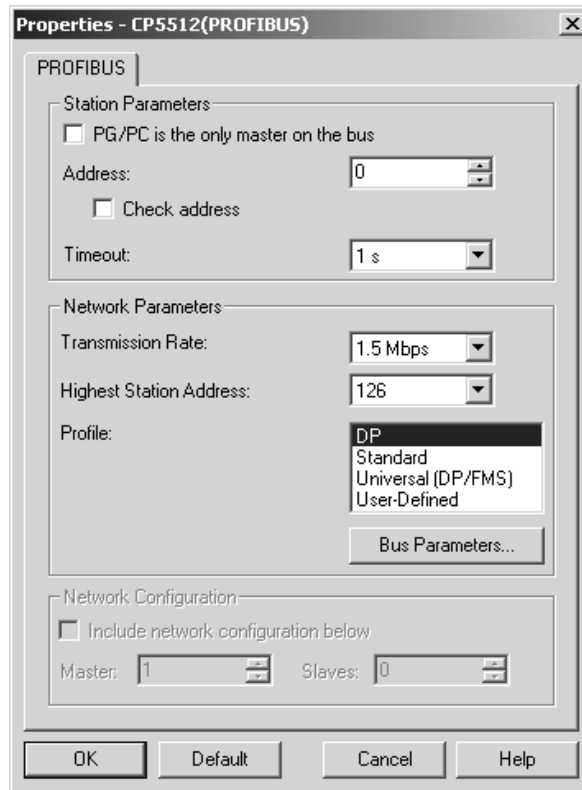

11308AEN

Figure 15: Setting properties

- Set the required parameters and ensure that the PC (in most cases) is added as a class 2 master in an existing PROFIBUS network.
  - If a PLC is active as a class 1 master, the check box [PG/PC is the only master on Bus] must be deactivated.
  - Assign the PC a free address that is not yet reserved by other masters or slaves.
  - The baud rate must match the baud rate if the class 1 master.
- Select "DP" as the profile or set the bus timing parameters according to the existing PROFIBUS network.





- Close the configuration dialog and open the following dialog box using the "Diagnostics" button to check it.

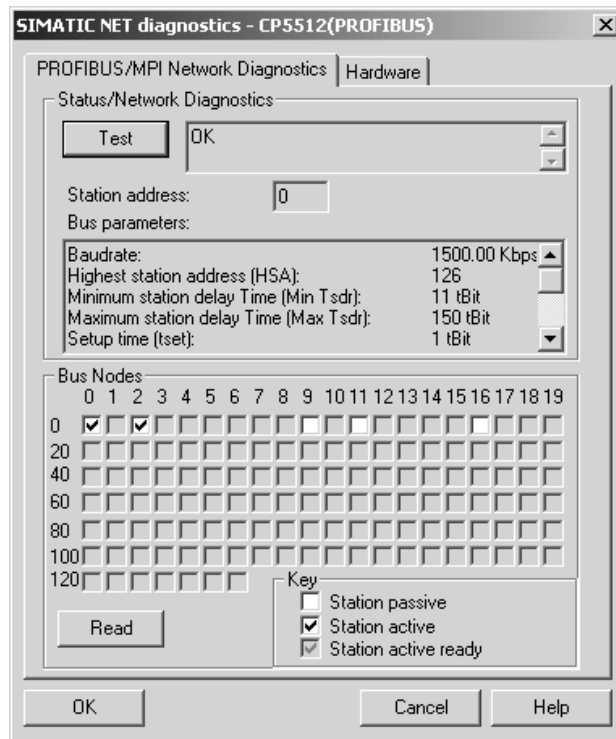

11309AEN

Figure 16: SIMATIC NET diagnostics

Everything has been correctly configured up to now when the "OK" status is displayed after pressing the "Test" button and all devices on the PROFIBUS are displayed using the "Read" button. You can now operate MOVITOOLS® MotionStudio via PROFIBUS-DP-V1.



#### 8.6 Configuration of SEW communication server

To operate MOVITOOLS® MotionStudio via PROFIBUS DP-V1, you require the CP5512-PC option card and the associated Softnet-DP driver package from Siemens. The PC is connected to an existing PROFIBUS network as a class 2 master and can communicate with inverters via acyclic parameter services using the DP-V1 protocol. To be able to operate the MOVITOOLS® MotionStudio via PROFIBUS, you must first configure the SEW communication server.

##### 8.6.1 Establishing communication

MOVITOOLS® MotionStudio allows you to communicate with the electronics products from SEW-EURODRIVE GmbH&CoKG via several, different communication paths at the same time.

When you start MOVITOOLS® MotionStudio, you will also start the SEW communication server, and an additional icon  will appear in the Windows status bar.

##### 8.6.2 Procedure

3 steps are involved in configuring the communication:

1. Start the SEW communication server by double-clicking the icon in the Windows task bar.



11327AXX



2. Activate the communication media tool bar by pressing the depicted icon.

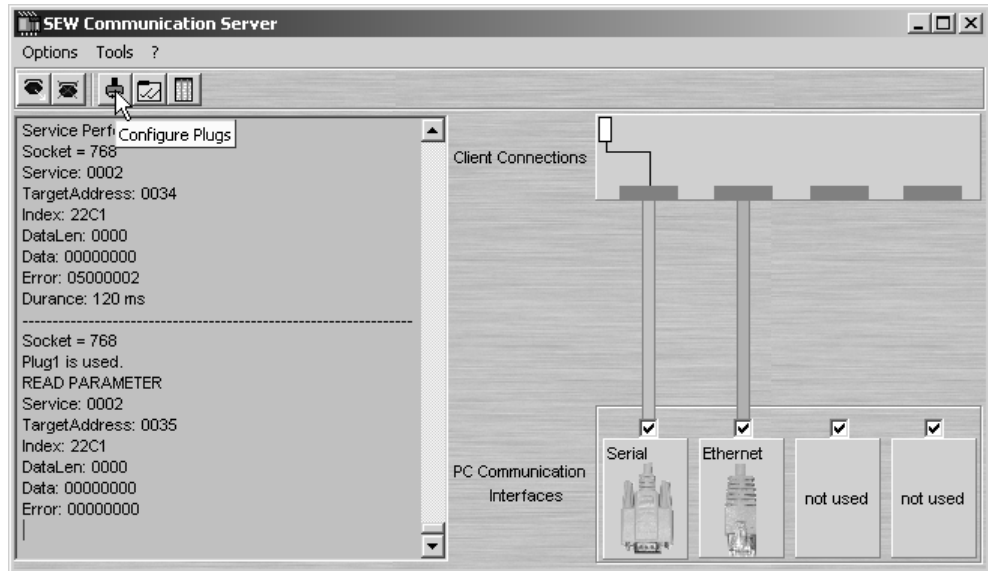

11325AXX

3. Configure the requested interface using drag and drop. Use the mouse to drag the required connection from the [Available Plugs] field to one of the four communication channels and enter the information in the dialog windows.

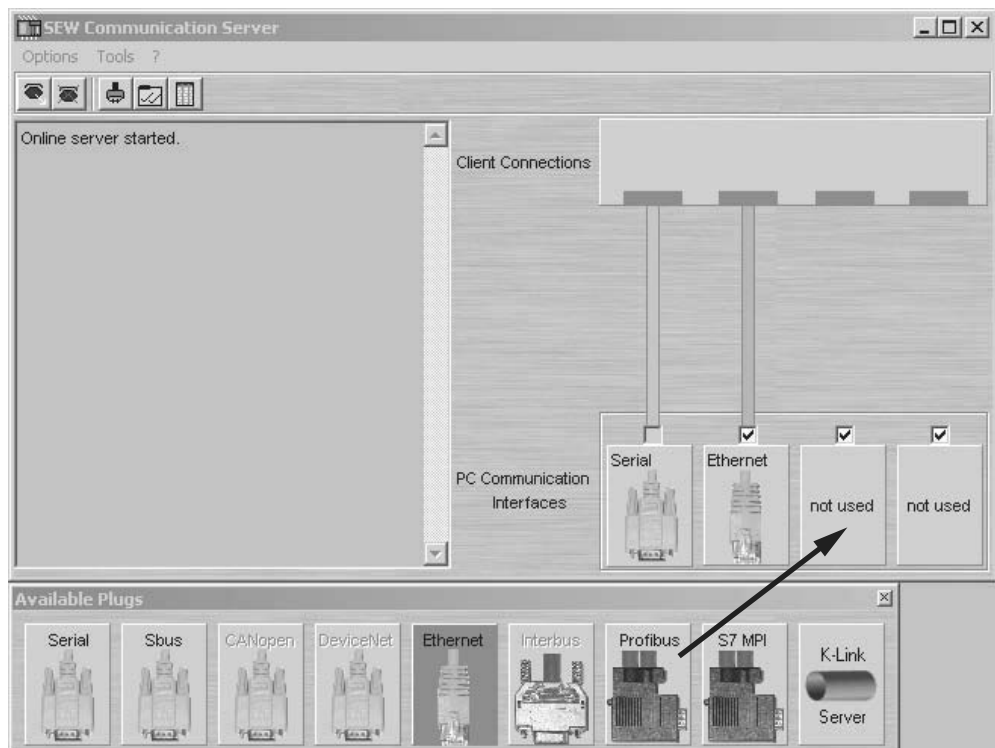

58656AXX



## Operation of MOVITOOLS® MotionStudio via PROFIBUS

### Configuration of SEW communication server

When configuring the PROFIBUS connection, you can set up the PROFIBUS server when starting MOVITOOLS® MotionStudio by activating the following dialog:

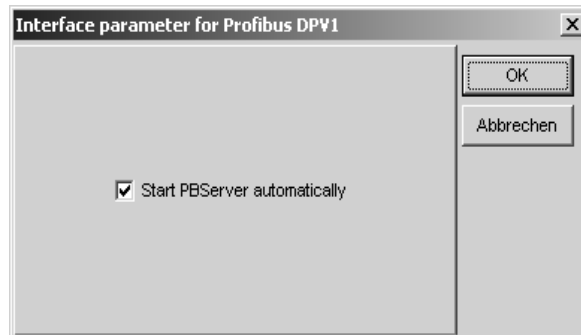

11311AEN

The following message appears when attempting to establish communication with PROFIBUS:

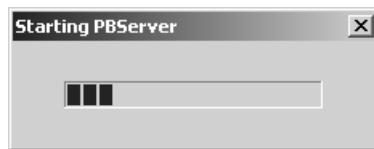

11312AXX

After the PROFIBUS connection is successfully started, the PB server icon  appears in the Windows task bar.

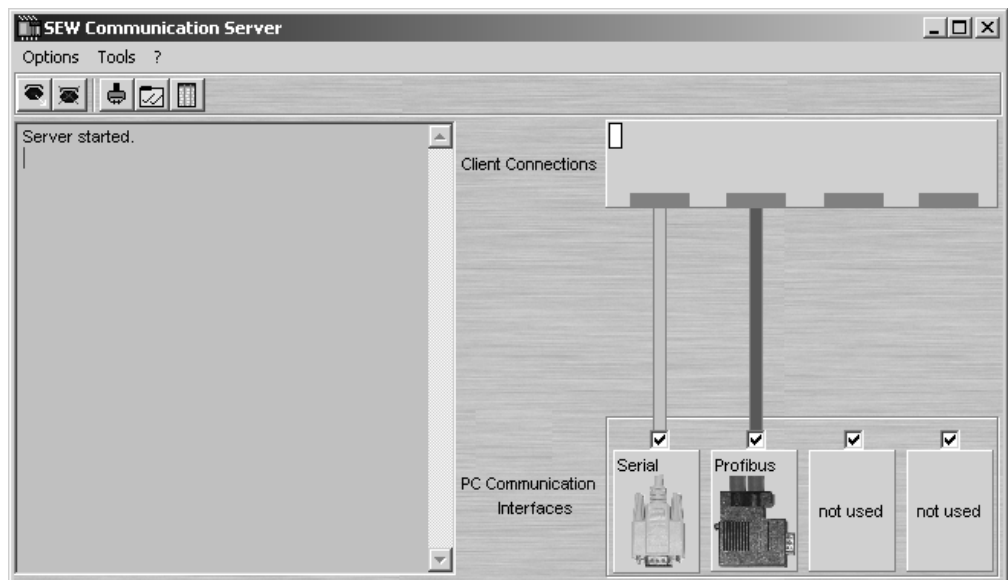

11310AXX



### 8.7 Automatic search for connected units (unit scan)

After pressing the <F5> function key or the "Online-Scan" button , all configured communication channels will be searched automatically and the addressable units displayed in the unit tree.

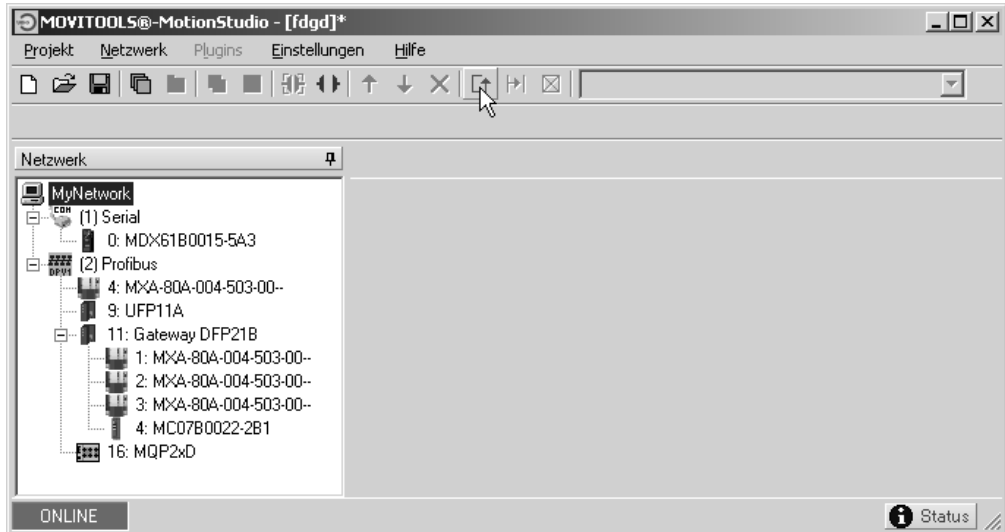

11315ADE

### 8.8 Activating online operation

- Perform the unit scan (see section 8.7).
- Use the mouse to highlight the unit you want to operate. Switch MOVITOOLS® MotionStudio to online mode by pressing the "Online mode" button.

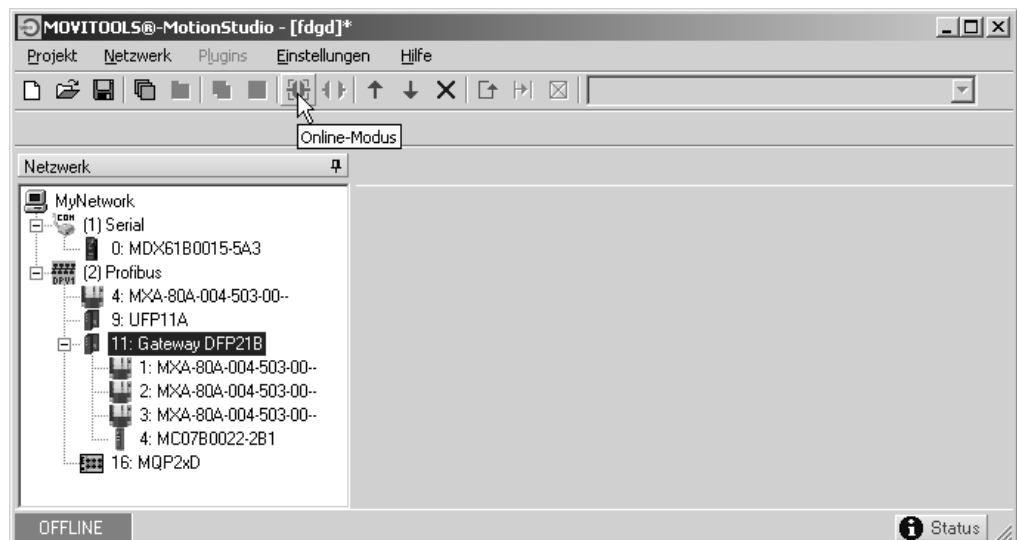

11316ADE

- Now highlight the unit you want to operate and activate the plug-in menu using the right mouse button.



### **8.9 Known problems when operating MOVITOOLS® MotionStudio**

Check the following points if problems occur during configuration:

- Is the PC connected to the PROFIBUS without violating the bus structure?
- Are the terminating resistors at the bus connectors correctly switched?
- Is the bus address of the PC still available for use?

Operation via SIMATIC NET:

- Is the check box "PG/PC is the only master on the bus" enabled/disabled?
- Is the baud rate set correctly?



## **9 Error Diagnostics**

### **9.1 Diagnostic procedures**

The diagnostic procedures described in the following section demonstrate the fault analysis methods for the most frequent problems:

- Inverter does not work on PROFIBUS-DP
- Inverter cannot be controlled using the DP master

For more information dealing specifically with the inverter parameter settings for various fieldbus applications, refer to the *Fieldbus Unit Profile and MOVIDRIVE® Parameter List* manual. In addition, read the current information on the GSD disk.

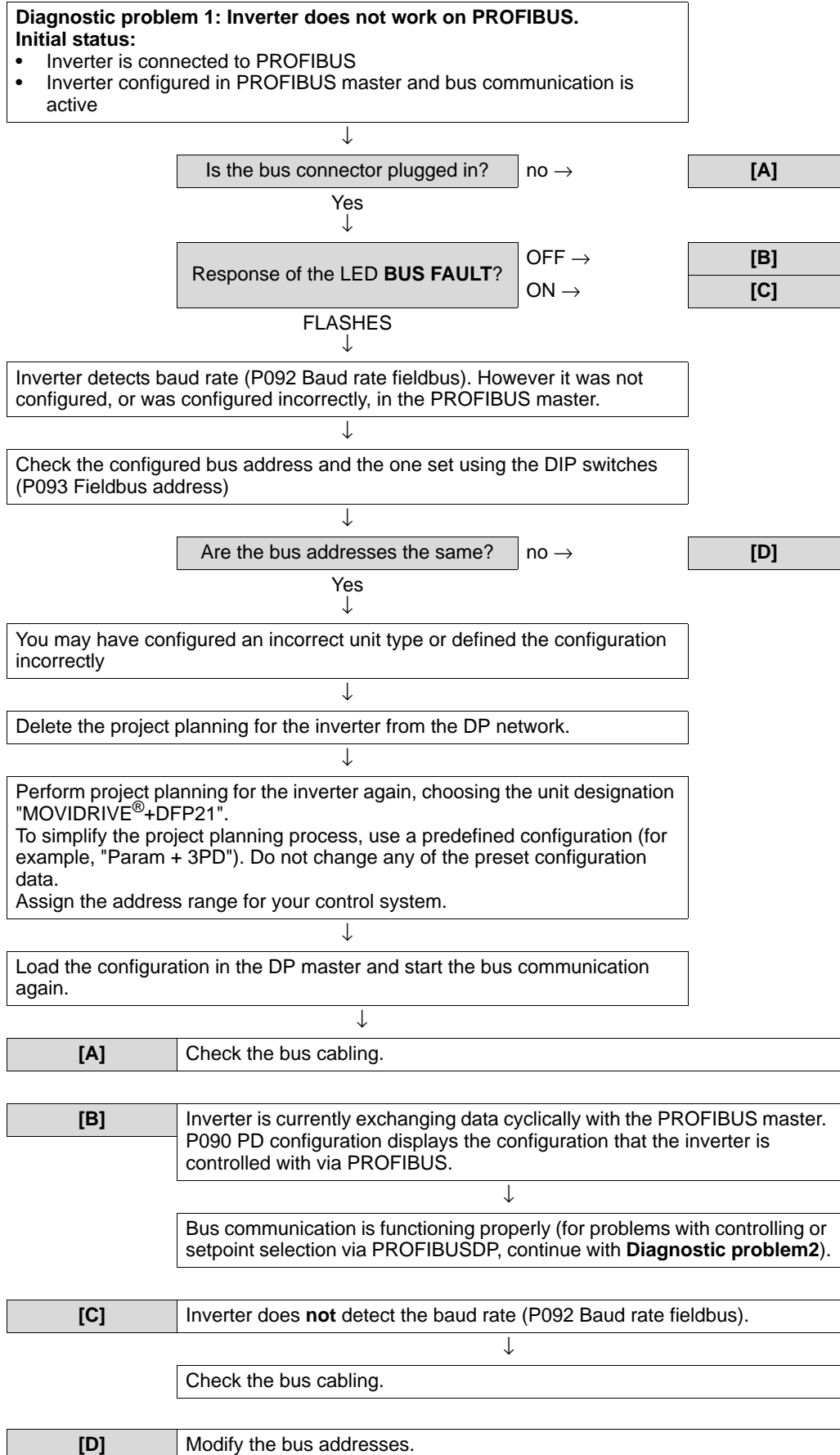







### 9.2 List of errors

Error code	Designation	Response	Cause	Measure
17	Stack overflow	SBus communication stopped	Malfunction of inverter electronics, possibly due to EMC influence	Check grounding and shielding and improve, if necessary. Consult SEW service if the error occurs again.
18	Stack underflow	SBus communication stopped		
19	NMI	SBus communication stopped		
20	Undefined opcode	SBus communication stopped		
21	Protection fault	SBus communication stopped		
22	Illegal word operand access	SBus communication stopped		
23	Illegal instruction access	SBus communication stopped		
25	Eeprom	SBus communication stopped	Error while accessing EEPROM	Activate factory settings, perform reset and set parameters for DFP again. Contact SEW service if the error occurs again.
28	Fieldbus timeout	Default: PO data = 0 Error response adjustable via P831	No communication between master and slave within the projected response monitoring.	<ul style="list-style-type: none"> <li>• Check communications routine of the master</li> <li>• Extend the fieldbus timeout interval (response monitoring) in the master configuration or deactivate monitoring</li> </ul>
37	Watchdog error	SBus communication stopped	Error during execution of system software	Contact SEW Service.
45	Initialization error	SBus communication stopped	Error after self-test during reset	Perform a reset. Consult SEW service if the error occurs again.
111	System error device timeout	None	Check the red system error LED ( <b>H1</b> ) of the DFP. If this LED is on, one or several stations on the SBus could not be addressed within the timeout interval. If the red system error LED ( <b>H1</b> ) flashes, the DFP itself is in an error state. In this case, error F111 was reported to the control only via fieldbus.	Check voltage supply and SBus cabling, check SBus terminating resistors. Check the project planning if the DFP was configured with the PC. Switch DFP off and on again. If the error is still present, query the error via diagnostic interface and perform the action described in this table.

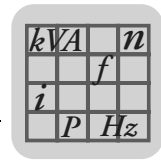

## 10 Technical Data

### 10.1 Option DFP21B for MOVIDRIVE® MDX61B

Option DFP21B (MOVIDRIVE® MDX61B)	
<b>Part number</b>	824 240 2
<b>Power consumption</b>	P = 3 W
<b>PROFIBUS protocol options</b>	PROFIBUSDP and DP-V1 according to IEC 61158
<b>Automatic baud rate detection</b>	9.6 kBaud to 12 MBaud
<b>Connection technology</b>	<ul style="list-style-type: none"> <li>Via 9-pin sub D plug</li> <li>Pin assignment according to IEC 61158</li> </ul>
<b>Bus termination</b>	Not integrated, implement using suitable PROFIBUS plug with terminating resistors that can be switched on.
<b>Station address</b>	1 to 125, adjustable via DIP switches
<b>Name of the GSD file</b>	<ul style="list-style-type: none"> <li>SEW_6003.GSD (PROFIBUS DP)</li> <li>SEWA6003.GSD (PROFIBUS DP-V1)</li> </ul>
<b>DP ident. number</b>	6003 <sub>hex</sub> = 24579 <sub>dec</sub>
<b>Application-specific parameter-setting data (Set-Prm application data)</b>	<ul style="list-style-type: none"> <li>Length: 9 bytes</li> <li>Hex parameter settings 00,00,00,06,81,00,00,01 = DP diagnostics alarm = <b>OFF</b></li> <li>Hex parameter settings 00,00,00,06,81,00,00,01,00 = DP diagnostics alarm = <b>ON</b></li> </ul>
<b>DP configurations for DDLM_Chk_Cfg</b>	<ul style="list-style-type: none"> <li>F0hex = 1 process data word (1 I/O word)</li> <li>F1hex = 2 process data words (2 I/O words)</li> <li>F2hex = 3 process data words (3 I/O words)</li> <li>0hex, F5hex = 6 process data words (6 I/O words)</li> <li>0hex, F9hex = 10 process data words (10 I/O words)</li> <li>F3hex, F0hex = parameter channel + 1 process data word (5 I/O words)</li> <li>F3hex, F1hex = parameter channel + 2 process data words (6 I/O words)</li> <li>F3hex, F2hex = parameter channel + 3 process data words (7 I/O words)</li> <li>F3hex, F5hex = parameter channel + 6 process data words (10 I/O words)</li> <li>F3hex, F9hex = parameter channel +10 process data words (14 I/O words)</li> </ul>
<b>Diagnostics data</b>	<ul style="list-style-type: none"> <li>Max. 8 bytes</li> <li>Standard diagnostics: 6 bytes</li> </ul>
<b>Tools for startup</b>	<ul style="list-style-type: none"> <li>PC program MOVITools® MotionStudio</li> <li>DBG11B keypad</li> </ul>

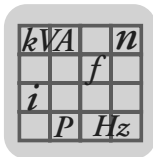

## 10.2 DFP21B option for MOVITRAC® B and UOH11B gateway housing

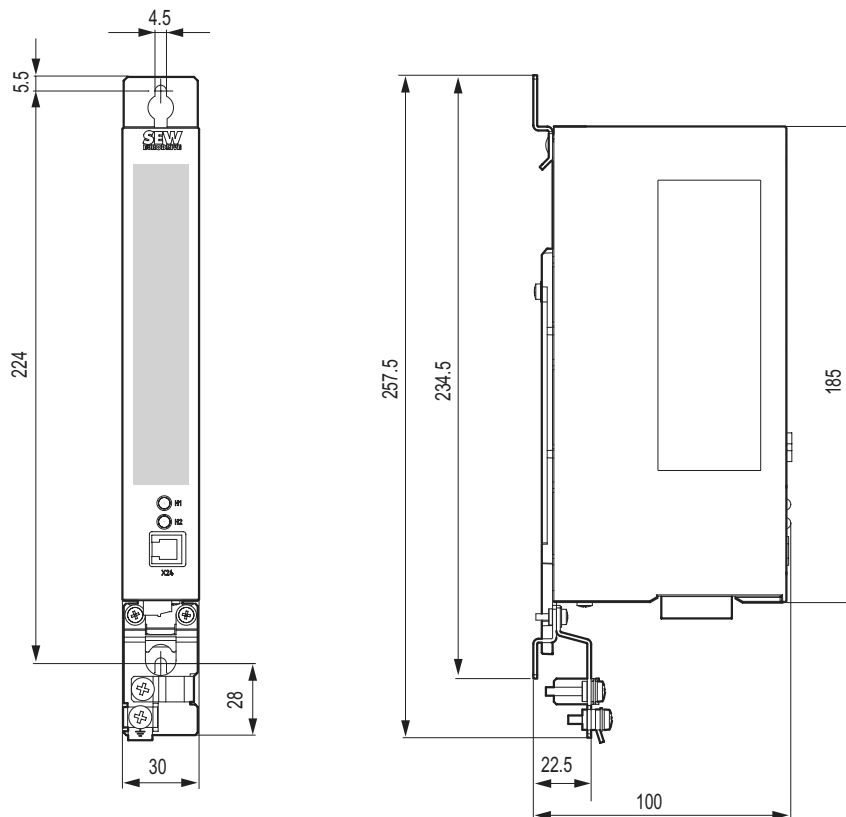

59796AXX

Figure 17: Device dimensions of the UOH11B gateway housing

DFP21B option (MOVITRAC® B gateway)	
Part number	824 240 2
External voltage supply	V = DC 24 V (-15 %, +20 %) I <sub>max</sub> = DC 200 mA P <sub>max</sub> = 3.4 W
PROFIBUS protocol options	PROFIBUS DP and DP-V1 according to IEC 61158
Automatic baud rate detection	9.6 kBaud to 12 MBaud
Connection technology	<ul style="list-style-type: none"> <li>Via 9-pin sub D plug</li> <li>Pin assignment according to IEC 61158</li> </ul>
Bus termination	Not integrated, must be implemented using suitable PROFIBUS connector with switchable terminating resistors.
Station address	1 to 125, adjustable via DIP switches
Name of the GSD file	SEW_6009.GSD (PROFIBUSDP-V1)
DP ident. number	6009 <sub>hex</sub> = 24585 <sub>dec</sub>
Application-specific parameter setting data (Set-Prm application data)	<ul style="list-style-type: none"> <li>Length: 3bytes</li> <li>Hex parameter setting 00,00,00</li> </ul>
DP configurations for DDLM_Chk_Cfg	See section "Configuration of process data" on page 37.
Diagnostics data	<ul style="list-style-type: none"> <li>Standard diagnostics: 6 bytes</li> </ul>
Tools for startup	<ul style="list-style-type: none"> <li>PC program MOVITOOLS® MotionStudio</li> </ul>



## 11 Index

- A**
- Activating online operation .....93
  - Additional code .....57
  - Assembly
    - Installing and removing an option card* .....15
    - Installing the DFP21B option card in MOVITRAC® B* .....16
    - MOVIDRIVE® MDX61B with DFP21B option card* .....14
    - UOH11B gateway housing* .....18
  - Autosetup for gateway operation .....40
- B**
- Baud rate ..... 18, 21, 99, 100
  - Bus cables .....22
  - Bus termination ..... 22, 99, 100
- C**
- C1 master
    - Project planning* .....77
  - Configuration of the process data .....37
  - Configuration of the PROFIBUS-DP interface ....36
  - Configuring SIMATIC NET .....87
  - Configuring the PROFIBUS option card .....12
  - Connection .....17
    - DFP21B option* .....20
  - Connection technology ..... 99, 100
  - Control
    - MOVIDRIVE® MDX61B* .....45
    - MOVITRAC® B* .....47
  - Control example .....46
- D**
- Data exchange via PROFIBUSDP .....11
  - Data exchange via PROFIBUSDP-V1 .....11
  - DFP21B
    - Connection* .....20
    - Operating displays* .....24
    - Terminal description* .....20
  - DFP21B operating displays .....24
  - Diagnostics .....13
    - MOVIDRIVE® MDX61B external diagnostics* .....32
  - DP configuration ..... 36, 37, 39, 99, 100
    - for MOVIDRIVE® MDX61B* .....29
    - universal* .....30
  - DP ident. number ..... 99, 100
- E**
- Error class .....56
  - Error code .....56
  - Error codes of the DP-V1 services .....84
  - Error Diagnostics .....95
  - Explanation of symbols .....6
- F**
- Fieldbus monitor ..... 13
  - Functions
    - PROFIBUSDP-V1* ..... 59
- G**
- GSD file ..... 35, 99, 100
    - for operation in MOVITRAC® B* ..... 34
    - for operation in UOH11B gateway housing* . 34
    - for PROFIBUSDP* ..... 26
    - for PROFIBUSDP-V1* ..... 27
    - Validity for DFP21B* ..... 26
- I**
- Ident number ..... 99, 100
  - Incorrect service execution ..... 51
  - Index addressing ..... 51
  - Internal communication error ..... 58
- L**
- LEDs, PROFIBUS ..... 24
  - Length specification ..... 58
  - Liability for defects ..... 7
- M**
- Monitoring functions ..... 12
  - MOVIDRIVE® MDX61B
    - Control* ..... 45
    - Setting the drive inverter* ..... 42
  - MOVIDRIVE® MDX61B external diagnostics ..... 32
  - MOVITOOLS® MotionStudio
    - PROFIBUS Operation* ..... 85
  - MOVITRAC® B
    - Control* ..... 47
    - Setting the frequency inverter* ..... 43
- N**
- Notes
    - Assembly / Installation* ..... 14
    - Documentation* ..... 6
    - Important notes* ..... 6
    - Safety* ..... 8
- O**
- Option card
    - Installation and removal* ..... 15
- P**
- Parameter channel
    - Data range* ..... 51
    - Structure* ..... 49
  - Parameter channel data range ..... 51
  - Parameter channel management ..... 50
  - Parameter channel structure ..... 49
  - Parameter channel, management ..... 50
  - Parameter data format ..... 54
  - Parameter settings



<i>Procedure</i> .....	54	SIMATIC STEP7	
<i>Return codes</i> .....	56	<i>Program example</i> .....	55
<i>via PROFIBUS DP</i> .....	49	Station address .....	99, 100
Parameter, reading .....	52	<i>Settings</i> .....	23
Parameter-setting data .....	99, 100	Storage .....	8
Part number .....	99, 100	System bus .....	17
Pin assignment .....	21	<b>T</b>	
Process data configuration .....	37	Technical data	
PROFIBUS		<i>DFP21B option for MOVITRAC® B</i> .....	100
<i>Configuring the option card</i> .....	12	<i>DFP21B option for UOH11B gateway</i>	
<i>LEDs</i> .....	24	<i>housing</i> .....	100
PROFIBUS DP		<i>Option DFP21B for MOVIDRIVE®</i>	
<i>Data exchange</i> .....	11	MDX61B .....	99
<i>Operating characteristics</i> .....	45	Terminal description	
<i>Parameter setting procedure</i> .....	54	<i>DFP21B option</i> .....	20
<i>Parameter settings</i> .....	49	Timeout	
<i>Timeout</i> .....	46	<i>PROFIBUSDP</i> .....	46
PROFIBUS DP operating characteristics .....	45	<i>SBus</i> .....	48
PROFIBUSDP-V1		Transport .....	8
<i>Alarm handling</i> .....	61	<b>U</b>	
<i>Data exchange</i> .....	11	Unit scan .....	93
<i>Functions</i> .....	59	Universal configuration .....	39
<i>Services</i> .....	61	Universal DP configuration .....	30
<i>Structure of the parameter channel</i> .....	63	<b>W</b>	
Program example		WRITE .....	53
SIMATIC S7 .....	78	Write parameter .....	53
SIMATIC STEP7 .....	55		
Project planning			
<i>C1 master</i> .....	77		
<i>DP master with MOVIDRIVE® GSD file</i> .....	26		
<i>DP master with MOVITRAC® and gateway</i>			
<i>DFP21B</i> .....	34		
<i>Procedure</i> .....	28		
Protocol options .....	99, 100		
<b>R</b>			
READ .....	52		
Return codes for parameter setting .....	56		
<b>S</b>			
Safety notes .....	8		
<i>Bus systems</i> .....	8		
<i>Installation / assembly</i> .....	9		
<i>Startup / operation</i> .....	9		
<i>Transport / storage</i> .....	8		
SBus			
<i>Timeout</i> .....	48		
Service coding .....	58		
Setting			
<i>MOVIDRIVE® MDX61B drive inverter</i> .....	42		
<i>MOVITRAC® B frequency inverter</i> .....	43		
SEW communication server .....	90		
Shielding .....	22		
SIMATIC NET			
<i>Configuration</i> .....	87		
SIMATIC S7 .....	46		
<i>Program example</i> .....	78		



## Address List

Germany			
<b>Headquarters Production Sales</b>	<b>Bruchsal</b>	SEW-EURODRIVE GmbH & Co KG Ernst-Blickle-Straße 42 D-76646 Bruchsal P.O. Box Postfach 3023 • D-76642 Bruchsal	Tel. +49 7251 75-0 Fax +49 7251 75-1970 <a href="http://www.sew-eurodrive.de">http://www.sew-eurodrive.de</a> <a href="mailto:sew@sew-eurodrive.de">sew@sew-eurodrive.de</a>
<b>Service Competence Center</b>	<b>Central</b> Gear units / Motors	SEW-EURODRIVE GmbH & Co KG Ernst-Blickle-Straße 1 D-76676 Graben-Neudorf	Tel. +49 7251 75-1710 Fax +49 7251 75-1711 <a href="mailto:sc-mitte-gm@sew-eurodrive.de">sc-mitte-gm@sew-eurodrive.de</a>
	<b>Central</b> Electronics	SEW-EURODRIVE GmbH & Co KG Ernst-Blickle-Straße 42 D-76646 Bruchsal	Tel. +49 7251 75-1780 Fax +49 7251 75-1769 <a href="mailto:sc-mitte-e@sew-eurodrive.de">sc-mitte-e@sew-eurodrive.de</a>
	<b>North</b>	SEW-EURODRIVE GmbH & Co KG Alte Ricklinger Straße 40-42 D-30823 Garbsen (near Hannover)	Tel. +49 5137 8798-30 Fax +49 5137 8798-55 <a href="mailto:sc-nord@sew-eurodrive.de">sc-nord@sew-eurodrive.de</a>
	<b>East</b>	SEW-EURODRIVE GmbH & Co KG Dänkritzter Weg 1 D-08393 Meerane (near Zwickau)	Tel. +49 3764 7606-0 Fax +49 3764 7606-30 <a href="mailto:sc-ost@sew-eurodrive.de">sc-ost@sew-eurodrive.de</a>
	<b>South</b>	SEW-EURODRIVE GmbH & Co KG Domagkstraße 5 D-85551 Kirchheim (near München)	Tel. +49 89 909552-10 Fax +49 89 909552-50 <a href="mailto:sc-sued@sew-eurodrive.de">sc-sued@sew-eurodrive.de</a>
	<b>West</b>	SEW-EURODRIVE GmbH & Co KG Siemensstraße 1 D-40764 Langenfeld (near Düsseldorf)	Tel. +49 2173 8507-30 Fax +49 2173 8507-55 <a href="mailto:sc-west@sew-eurodrive.de">sc-west@sew-eurodrive.de</a>
	<b>Drive Service Hotline / 24 Hour Service</b>		
Additional addresses for service in Germany provided on request!			
France			
<b>Production Sales Service</b>	<b>Hagenau</b>	SEW-USOCOME 48-54, route de Soufflenheim B. P. 20185 F-67506 Hagenau Cedex	Tel. +33 3 88 73 67 00 Fax +33 3 88 73 66 00 <a href="http://www.usocome.com">http://www.usocome.com</a> <a href="mailto:sew@usocome.com">sew@usocome.com</a>
<b>Assembly Sales Service</b>	<b>Bordeaux</b>	SEW-USOCOME Parc d'activités de Magellan 62, avenue de Magellan - B. P. 182 F-33607 Pessac Cedex	Tel. +33 5 57 26 39 00 Fax +33 5 57 26 39 09
	<b>Lyon</b>	SEW-USOCOME Parc d'Affaires Roosevelt Rue Jacques Tati F-69120 Vaulx en Velin	Tel. +33 4 72 15 37 00 Fax +33 4 72 15 37 15
	<b>Paris</b>	SEW-USOCOME Zone industrielle 2, rue Denis Papin F-77390 Verneuil l'Etang	Tel. +33 1 64 42 40 80 Fax +33 1 64 42 40 88
Additional addresses for service in France provided on request!			
Algeria			
<b>Sales</b>	<b>Alger</b>	Réducom 16, rue des Frères Zagnoun Bellevue El-Harrach 16200 Alger	Tel. +213 21 8222-84 Fax +213 21 8222-84
Argentina			
<b>Assembly Sales Service</b>	<b>Buenos Aires</b>	SEW EURODRIVE ARGENTINA S.A. Centro Industrial Garin, Lote 35 Ruta Panamericana Km 37,5 1619 Garin	Tel. +54 3327 4572-84 Fax +54 3327 4572-21 <a href="mailto:sewar@sew-eurodrive.com.ar">sewar@sew-eurodrive.com.ar</a>



## Address List

Australia			
Assembly Sales Service	<b>Melbourne</b>	SEW-EURODRIVE PTY. LTD. 27 Beverage Drive Tullamarine, Victoria 3043	Tel. +61 3 9933-1000 Fax +61 3 9933-1003 <a href="http://www.sew-eurodrive.com.au">http://www.sew-eurodrive.com.au</a> enquires@sew-eurodrive.com.au
	<b>Sydney</b>	SEW-EURODRIVE PTY. LTD. 9, Sleigh Place, Wetherill Park New South Wales, 2164	Tel. +61 2 9725-9900 Fax +61 2 9725-9905 enquires@sew-eurodrive.com.au
	<b>Townsville</b>	SEW-EURODRIVE PTY. LTD. 12 Leyland Street Garbutt, QLD 4814	Tel. +61 7 4779 4333 Fax +61 7 4779 5333 enquires@sew-eurodrive.com.au
Austria			
Assembly Sales Service	<b>Wien</b>	SEW-EURODRIVE Ges.m.b.H. Richard-Strauss-Strasse 24 A-1230 Wien	Tel. +43 1 617 55 00-0 Fax +43 1 617 55 00-30 <a href="http://sew-eurodrive.at">http://sew-eurodrive.at</a> sew@sew-eurodrive.at
Belgium			
Assembly Sales Service	<b>Brüssel</b>	SEW Caron-Vector S.A. Avenue Eiffel 5 B-1300 Wavre	Tel. +32 10 231-311 Fax +32 10 231-336 <a href="http://www.caron-vector.be">http://www.caron-vector.be</a> info@caron-vector.be
Brazil			
Production Sales Service	<b>Sao Paulo</b>	SEW-EURODRIVE Brasil Ltda. Avenida Amâncio Gaiolli, 50 Caixa Postal: 201-07111-970 Guarulhos/SP - Cep.: 07251-250	Tel. +55 11 6489-9133 Fax +55 11 6480-3328 <a href="http://www.sew.com.br">http://www.sew.com.br</a> sew@sew.com.br
Additional addresses for service in Brazil provided on request!			
Bulgaria			
Sales	<b>Sofia</b>	BEVER-DRIVE GmbH Bogdanovetz Str. 1 BG-1606 Sofia	Tel. +359 2 9151160 Fax +359 2 9151166 bever@fastbg.net
Cameroon			
Sales	<b>Douala</b>	Electro-Services Rue Drouot Akwa B.P. 2024 Douala	Tel. +237 4322-99 Fax +237 4277-03
Canada			
Assembly Sales Service	<b>Toronto</b>	SEW-EURODRIVE CO. OF CANADA LTD. 210 Walker Drive Bramalea, Ontario L6T3W1	Tel. +1 905 791-1553 Fax +1 905 791-2999 <a href="http://www.sew-eurodrive.ca">http://www.sew-eurodrive.ca</a> l.reynolds@sew-eurodrive.ca
	<b>Vancouver</b>	SEW-EURODRIVE CO. OF CANADA LTD. 7188 Honeyman Street Delta, B.C. V4G 1 E2	Tel. +1 604 946-5535 Fax +1 604 946-2513 b.wake@sew-eurodrive.ca
	<b>Montreal</b>	SEW-EURODRIVE CO. OF CANADA LTD. 2555 Rue Leger Street LaSalle, Quebec H8N 2V9	Tel. +1 514 367-1124 Fax +1 514 367-3677 a.peluso@sew-eurodrive.ca
Additional addresses for service in Canada provided on request!			
Chile			
Assembly Sales Service	<b>Santiago de Chile</b>	SEW-EURODRIVE CHILE LTDA. Las Encinas 1295 Parque Industrial Valle Grande LAMP RCH-Santiago de Chile P.O. Box Casilla 23 Correo Quilicura - Santiago - Chile	Tel. +56 2 75770-00 Fax +56 2 75770-01 <a href="http://www.sew-eurodrive.cl">www.sew-eurodrive.cl</a> ventas@sew-eurodrive.cl





China			
<b>Production Assembly Sales Service</b>	<b>Tianjin</b>	SEW-EURODRIVE (Tianjin) Co., Ltd. No. 46, 7th Avenue, TEDA Tianjin 300457	Tel. +86 22 25322612 Fax +86 22 25322611 gm-tianjin@sew-eurodrive.cn http://www.sew-eurodrive.com.cn
<b>Assembly Sales Service</b>	<b>Suzhou</b>	SEW-EURODRIVE (Suzhou) Co., Ltd. 333, Suhong Middle Road Suzhou Industrial Park Jiangsu Province, 215021 P. R. China	Tel. +86 512 62581781 Fax +86 512 62581783 suzhou@sew.com.cn
Additional addresses for service in China provided on request!			
Colombia			
<b>Assembly Sales Service</b>	<b>Bogotá</b>	SEW-EURODRIVE COLOMBIA LTDA. Calle 22 No. 132-60 Bodega 6, Manzana B Santafé de Bogotá	Tel. +57 1 54750-50 Fax +57 1 54750-44 http://www.sew-eurodrive.com.co sewcol@sew-eurodrive.com.co
Croatia			
<b>Sales Service</b>	<b>Zagreb</b>	KOMPEKS d. o. o. PIT Erdödy 4 II HR 10 000 Zagreb	Tel. +385 1 4613-158 Fax +385 1 4613-158 kompeks@net.hr
Czech Republic			
<b>Sales</b>	<b>Praha</b>	SEW-EURODRIVE CZ S.R.O. Business Centrum Praha Luzna 591 CZ-16000 Praha 6 - Vokovice	Tel. +420 220121234 Fax +420 220121237 http://www.sew-eurodrive.cz sew@sew-eurodrive.cz
Denmark			
<b>Assembly Sales Service</b>	<b>Kopenhagen</b>	SEW-EURODRIVEA/S Geminivej 28-30, P.O. Box 100 DK-2670 Greve	Tel. +45 43 9585-00 Fax +45 43 9585-09 http://www.sew-eurodrive.dk sew@sew-eurodrive.dk
Estonia			
<b>Sales</b>	<b>Tallin</b>	ALAS-KUUL AS Mustamäe tee 24 EE-10620Tallin	Tel. +372 6593230 Fax +372 6593231 veiko.soots@alas-kuul.ee
Finland			
<b>Assembly Sales Service</b>	<b>Lahti</b>	SEW-EURODRIVE OY Vesimäentie 4 FIN-15860 Hollola 2	Tel. +358 201 589-300 Fax +358 3 780-6211 sew@sew.fi http://www.sew-eurodrive.fi
Gabon			
<b>Sales</b>	<b>Libreville</b>	Electro-Services B.P. 1889 Libreville	Tel. +241 7340-11 Fax +241 7340-12
Great Britain			
<b>Assembly Sales Service</b>	<b>Normanton</b>	SEW-EURODRIVE Ltd. Beckbridge Industrial Estate P.O. Box No.1 GB-Normanton, West- Yorkshire WF6 1QR	Tel. +44 1924 893-855 Fax +44 1924 893-702 http://www.sew-eurodrive.co.uk info@sew-eurodrive.co.uk
Greece			
<b>Sales Service</b>	<b>Athen</b>	Christ. Boznos & Son S.A. 12, Mavromichali Street P.O. Box 80136, GR-18545 Piraeus	Tel. +30 2 1042 251-34 Fax +30 2 1042 251-59 http://www.boznos.gr info@boznos.gr



## Address List

Hong Kong			
Assembly Sales Service	Hong Kong	SEW-EURODRIVE LTD. Unit No. 801-806, 8th Floor Hong Leong Industrial Complex No. 4, Wang Kwong Road Kowloon, Hong Kong	Tel. +852 2 7960477 + 79604654 Fax +852 2 7959129 sew@sewhk.com
Hungary			
Sales Service	Budapest	SEW-EURODRIVE Kft. H-1037 Budapest Kunigunda u. 18	Tel. +36 1 437 06-58 Fax +36 1 437 06-50 office@sew-eurodrive.hu
India			
Assembly Sales Service	Baroda	SEW-EURODRIVE India Pvt. Ltd. Plot No. 4, Gidc Por Ramangamdi • Baroda - 391 243 Gujarat	Tel. +91 265 2831086 Fax +91 265 2831087 <a href="http://www.seweurodriveindia.com">http://www.seweurodriveindia.com</a> mdoffice@seweurodriveindia.com
Technical Offices	Bangalore	SEW-EURODRIVE India Private Limited 308, Prestige Centre Point 7, Edward Road Bangalore	Tel. +91 80 22266565 Fax +91 80 22266569 salesbang@seweurodriveinindia.com
Ireland			
Sales Service	Dublin	Alperon Engineering Ltd. 48 Moyle Road Dublin Industrial Estate Glasnevin, Dublin 11	Tel. +353 1 830-6277 Fax +353 1 830-6458
Israel			
Sales	Tel-Aviv	Liraz Handasa Ltd. Ahofer Str 34B / 228 58858 Holon	Tel. +972 3 5599511 Fax +972 3 5599512 lirazhandasa@barak-online.net
Italy			
Assembly Sales Service	Milano	SEW-EURODRIVE di R. Blicke & Co.s.a.s. Via Bernini,14 I-20020 Solaro (Milano)	Tel. +39 02 96 9801 Fax +39 02 96 799781 <a href="http://www.sew-eurodrive.it">http://www.sew-eurodrive.it</a> sewit@sew-eurodrive.it
Ivory Coast			
Sales	Abidjan	SICA Ste industrielle et commerciale pour l'Afrique 165, Bld de Marseille B.P. 2323, Abidjan 08	Tel. +225 2579-44 Fax +225 2584-36
Japan			
Assembly Sales Service	Toyoda-cho	SEW-EURODRIVE JAPAN CO., LTD 250-1, Shimoman-no, Iwata Shizuoka 438-0818	Tel. +81 538 373811 Fax +81 538 373814 sewjapan@sew-eurodrive.co.jp
Korea			
Assembly Sales Service	Ansan-City	SEW-EURODRIVE KOREA CO., LTD. B 601-4, Banweol Industrial Estate Unit 1048-4, Shingil-Dong Ansan 425-120	Tel. +82 31 492-8051 Fax +82 31 492-8056 <a href="http://www.sew-korea.co.kr">http://www.sew-korea.co.kr</a> master@sew-korea.co.kr
Latvia			
Sales	Riga	SIA Alas-Kuul Katlakalna 11C LV-1073 Riga	Tel. +371 7139253 Fax +371 7139386 <a href="http://www.alas-kuul.com">http://www.alas-kuul.com</a> info@alas-kuul.com



Lebanon			
<b>Sales</b>	<b>Beirut</b>	Gabriel Acar & Fils sarl B. P. 80484 Bourj Hammoud, Beirut	Tel. +961 1 4947-86 +961 1 4982-72 +961 3 2745-39 Fax +961 1 4949-71 gacar@beirut.com
Lithuania			
<b>Sales</b>	<b>Alytus</b>	UAB Irseva Naujoji 19 LT-62175 Alytus	Tel. +370 315 79204 Fax +370 315 56175 info@irseva.lt http://www.sew-eurodrive.lt
Luxembourg			
<b>Assembly Sales Service</b>	<b>Brüssel</b>	CARON-VECTOR S.A. Avenue Eiffel 5 B-1300 Wavre	Tel. +32 10 231-311 Fax +32 10 231-336 http://www.caron-vector.be info@caron-vector.be
Malaysia			
<b>Assembly Sales Service</b>	<b>Johore</b>	SEW-EURODRIVE SDN BHD No. 95, Jalan Seroja 39, Taman Johor Jaya 81000 Johor Bahru, Johor West Malaysia	Tel. +60 7 3549409 Fax +60 7 3541404 sales@sew-eurodrive.com.my
Mexico			
<b>Assembly Sales Service</b>	<b>Queretaro</b>	SEW-EURODRIVE MEXIKO SA DE CV SEM-981118-M93 Tequisquiapan No. 102 Parque Industrail Queretaro C.P. 76220 Queretaro, Mexico	Tel. +52 442 1030-300 Fax +52 442 1030-301 http://www.sew-eurodrive.com.mx scmexico@seweurodrive.com.mx
Morocco			
<b>Sales</b>	<b>Casablanca</b>	Afit 5, rue Emir Abdelkader MA 20300 Casablanca	Tel. +212 22618372 Fax +212 22618351 richard.miekisiak@premium.net.ma
Netherlands			
<b>Assembly Sales Service</b>	<b>Rotterdam</b>	VECTOR Aandrijftechniek B.V. Industrieweg 175 NL-3044 AS Rotterdam Postbus 10085 NL-3004 AB Rotterdam	Tel. +31 10 4463-700 Fax +31 10 4155-552 http://www.vector.nu info@vector.nu
New Zealand			
<b>Assembly Sales Service</b>	<b>Auckland</b>	SEW-EURODRIVE NEW ZEALAND LTD. P.O. Box 58-428 82 Greenmount drive East Tamaki Auckland	Tel. +64 9 2745627 Fax +64 9 2740165 http://www.sew-eurodrive.co.nz sales@sew-eurodrive.co.nz
	<b>Christchurch</b>	SEW-EURODRIVE NEW ZEALAND LTD. 10 Settlers Crescent, Ferrymead Christchurch	Tel. +64 3 384-6251 Fax +64 3 384-6455 sales@sew-eurodrive.co.nz
Norway			
<b>Assembly Sales Service</b>	<b>Moss</b>	SEW-EURODRIVE A/S Solgaard skog 71 N-1599 Moss	Tel. +47 69 241-020 Fax +47 69 241-040 http://www.sew-eurodrive.no sew@sew-eurodrive.no
Peru			
<b>Assembly Sales Service</b>	<b>Lima</b>	SEW DEL PERU MOTORES REDUCTORES S.A.C. Los Calderos, 120-124 Urbanizacion Industrial Vulcano, ATE, Lima	Tel. +51 1 3495280 Fax +51 1 3493002 http://www.sew-eurodrive.com.pe sewperu@sew-eurodrive.com.pe



## Address List

Poland			
<b>Assembly Sales Service</b>	<b>Lodz</b>	SEW-EURODRIVE Polska Sp.z.o.o. ul. Techniczna 5 PL-92-518 Lodz	Tel. +48 42 67710-90 Fax +48 42 67710-99 <a href="http://www.sew-eurodrive.pl">http://www.sew-eurodrive.pl</a> <a href="mailto:sew@sew-eurodrive.pl">sew@sew-eurodrive.pl</a>
Portugal			
<b>Assembly Sales Service</b>	<b>Coimbra</b>	SEW-EURODRIVE, LDA. Apartado 15 P-3050-901 Mealhada	Tel. +351 231 20 9670 Fax +351 231 20 3685 <a href="http://www.sew-eurodrive.pt">http://www.sew-eurodrive.pt</a> <a href="mailto:infosew@sew-eurodrive.pt">infosew@sew-eurodrive.pt</a>
Romania			
<b>Sales Service</b>	<b>Bucuresti</b>	Sialco Trading SRL str. Madrid nr.4 011785 Bucuresti	Tel. +40 21 230-1328 Fax +40 21 230-7170 <a href="mailto:sialco@sialco.ro">sialco@sialco.ro</a>
Russia			
<b>Assembly Sales Service</b>	<b>St. Petersburg</b>	ZAO SEW-EURODRIVE P.O. Box 36 195220 St. Petersburg Russia	Tel. +7 812 3332522 +7 812 5357142 Fax +7 812 3332523 <a href="http://www.sew-eurodrive.ru">http://www.sew-eurodrive.ru</a> <a href="mailto:sew@sew-eurodrive.ru">sew@sew-eurodrive.ru</a>
Senegal			
<b>Sales</b>	<b>Dakar</b>	SENEMECA Mécanique Générale Km 8, Route de Rufisque B.P. 3251, Dakar	Tel. +221 849 47-70 Fax +221 849 47-71 <a href="mailto:senemeca@sentoo.sn">senemeca@sentoo.sn</a>
Serbia and Montenegro			
<b>Sales</b>	<b>Beograd</b>	DIPAR d.o.o. Ustanicka 128a PC Košum, IV floor SCG-11000 Beograd	Tel. +381 11 347 3244 / +381 11 288 0393 Fax +381 11 347 1337 <a href="mailto:dipar@yubc.net">dipar@yubc.net</a>
Singapore			
<b>Assembly Sales Service</b>	<b>Singapore</b>	SEW-EURODRIVE PTE. LTD. No 9, Tuas Drive 2 Jurong Industrial Estate Singapore 638644	Tel. +65 68621701 Fax +65 68612827 <a href="http://www.sew-eurodrive.com.sg">http://www.sew-eurodrive.com.sg</a> <a href="mailto:sewsingapore@sew-eurodrive.com">sewsingapore@sew-eurodrive.com</a>
Slovakia			
<b>Sales</b>	<b>Bratislava</b>	SEW-Eurodrive SK s.r.o. Rybnicna 40 SK-83107 Bratislava	Tel. +421 2 49595201 Fax +421 2 49595200 <a href="http://www.sew.sk">http://www.sew.sk</a> <a href="mailto:sew@sew-eurodrive.sk">sew@sew-eurodrive.sk</a>
	<b>Zilina</b>	SEW-Eurodrive SK s.r.o. ul. Vojtecha Spanyola 33 SK-010 01 Zilina	Tel. +421 41 700 2513 Fax +421 41 700 2514 <a href="mailto:sew@sew-eurodrive.sk">sew@sew-eurodrive.sk</a>
	<b>Banská Bystrica</b>	SEW-Eurodrive SK s.r.o. Rudlovska cesta 85 SK-97411 Banská Bystrica	Tel. +421 48 414 6564 Fax +421 48 414 6566 <a href="mailto:sew@sew-eurodrive.sk">sew@sew-eurodrive.sk</a>
Slovenia			
<b>Sales Service</b>	<b>Celje</b>	Pakman - Pogonska Tehnika d.o.o. Ul. XIV. divizije 14 SLO - 3000 Celje	Tel. +386 3 490 83-20 Fax +386 3 490 83-21 <a href="mailto:pakman@siol.net">pakman@siol.net</a>
South Africa			
<b>Assembly Sales Service</b>	<b>Johannesburg</b>	SEW-EURODRIVE (PROPRIETARY) LIMITED Eurodrive House Cnr. Adcock Ingram and Aerodrome Roads Aeroton Ext. 2 Johannesburg 2013 P.O.Box 90004 Bertsham 2013	Tel. +27 11 248-7000 Fax +27 11 494-3104 <a href="http://www.sew.co.za">http://www.sew.co.za</a> <a href="mailto:dross@sew.co.za">dross@sew.co.za</a>



South Africa			
	<b>Capetown</b>	SEW-EURODRIVE (PROPRIETARY) LIMITED Rainbow Park Cnr. Racecourse & Omuramba Road Montague Gardens Cape Town P.O.Box 36556 Chempet 7442 Cape Town	Tel. +27 21 552-9820 Fax +27 21 552-9830 Telex 576 062 dswanepoel@sew.co.za
	<b>Durban</b>	SEW-EURODRIVE (PROPRIETARY) LIMITED 2 Monaceo Place Pinetown Durban P.O. Box 10433, Ashwood 3605	Tel. +27 31 700-3451 Fax +27 31 700-3847 dtait@sew.co.za
Spain			
<b>Assembly Sales Service</b>	<b>Bilbao</b>	SEW-EURODRIVE ESPAÑA, S.L. Parque Tecnológico, Edificio, 302 E-48170 Zamudio (Vizcaya)	Tel. +34 9 4431 84-70 Fax +34 9 4431 84-71 <a href="http://www.sew-eurodrive.es">http://www.sew-eurodrive.es</a> sew.spain@sew-eurodrive.es
Sweden			
<b>Assembly Sales Service</b>	<b>Jönköping</b>	SEW-EURODRIVE AB Gnejsvägen 6-8 S-55303 Jönköping Box 3100 S-55003 Jönköping	Tel. +46 36 3442-00 Fax +46 36 3442-80 <a href="http://www.sew-eurodrive.se">http://www.sew-eurodrive.se</a> info@sew-eurodrive.se
Switzerland			
<b>Assembly Sales Service</b>	<b>Basel</b>	Alfred Imhof A.G. Jurastrasse 10 CH-4142 Münchenstein bei Basel	Tel. +41 61 417 1717 Fax +41 61 417 1700 <a href="http://www.imhof-sew.ch">http://www.imhof-sew.ch</a> info@imhof-sew.ch
Thailand			
<b>Assembly Sales Service</b>	<b>Chon Buri</b>	SEW-EURODRIVE (Thailand) Ltd. Bangpakong Industrial Park 2 700/456, Moo.7, Tambol Donhuaroh Muang District Chon Buri 20000	Tel. +66 38 454281 Fax +66 38 454288 sewthailand@sew-eurodrive.com
Tunisia			
<b>Sales</b>	<b>Tunis</b>	T. M.S. Technic Marketing Service 7, rue Ibn El Heithem Z.I. SMMT 2014 Mégrine Erriadh	Tel. +216 1 4340-64 + 1 4320-29 Fax +216 1 4329-76 tms@tms.com.tn
Turkey			
<b>Assembly Sales Service</b>	<b>Istanbul</b>	SEW-EURODRIVE Hareket Sistemleri San. ve Tic. Ltd. Sti. Bagdat Cad. Koruma Cikmazi No. 3 TR-34846 Maltepe ISTANBUL	Tel. +90 216 4419163 / 164 3838014/15 Fax +90 216 3055867 sew@sew-eurodrive.com.tr
Ukraine			
<b>Sales Service</b>	<b>Dnepropetrovsk</b>	SEW-EURODRIVE Str. Rabochaja 23-B, Office 409 49008 Dnepropetrovsk	Tel. +380 56 370 3211 Fax +380 56 372 2078 <a href="http://www.sew-eurodrive.ua">http://www.sew-eurodrive.ua</a> sew@sew-eurodrive.ua
USA			
<b>Production Assembly Sales Service</b>	<b>Greenville</b>	SEW-EURODRIVE INC. 1295 Old Spartanburg Highway P.O. Box 518 Lyman, S.C. 29365	Tel. +1 864 439-7537 Fax Sales +1 864 439-7830 Fax Manuf. +1 864 439-9948 Fax Ass. +1 864 439-0566 Telex 805 550 <a href="http://www.seweurodrive.com">http://www.seweurodrive.com</a> cslyman@seweurodrive.com



## Address List

USA			
<b>Assembly Sales Service</b>	<b>San Francisco</b>	SEW-EURODRIVE INC. 30599 San Antonio St. Hayward, California 94544-7101	Tel. +1 510 487-3560 Fax +1 510 487-6381 cshayward@seweurodrive.com
	<b>Philadelphia/PA</b>	SEW-EURODRIVE INC. Pureland Ind. Complex 2107 High Hill Road, P.O. Box 481 Bridgeport, New Jersey 08014	Tel. +1 856 467-2277 Fax +1 856 845-3179 csbridgeport@seweurodrive.com
	<b>Dayton</b>	SEW-EURODRIVE INC. 2001 West Main Street Troy, Ohio 45373	Tel. +1 937 335-0036 Fax +1 937 440-3799 cstroy@seweurodrive.com
	<b>Dallas</b>	SEW-EURODRIVE INC. 3950 Platinum Way Dallas, Texas 75237	Tel. +1 214 330-4824 Fax +1 214 330-4724 csdallas@seweurodrive.com
Additional addresses for service in the USA provided on request!			
Venezuela			
<b>Assembly Sales Service</b>	<b>Valencia</b>	SEW-EURODRIVE Venezuela S.A. Av. Norte Sur No. 3, Galpon 84-319 Zona Industrial Municipal Norte Valencia, Estado Carabobo	Tel. +58 241 832-9804 Fax +58 241 838-6275 <a href="http://www.sew-eurodrive.com.ve">http://www.sew-eurodrive.com.ve</a> sewventas@cantv.net sewfinanzas@cantv.net







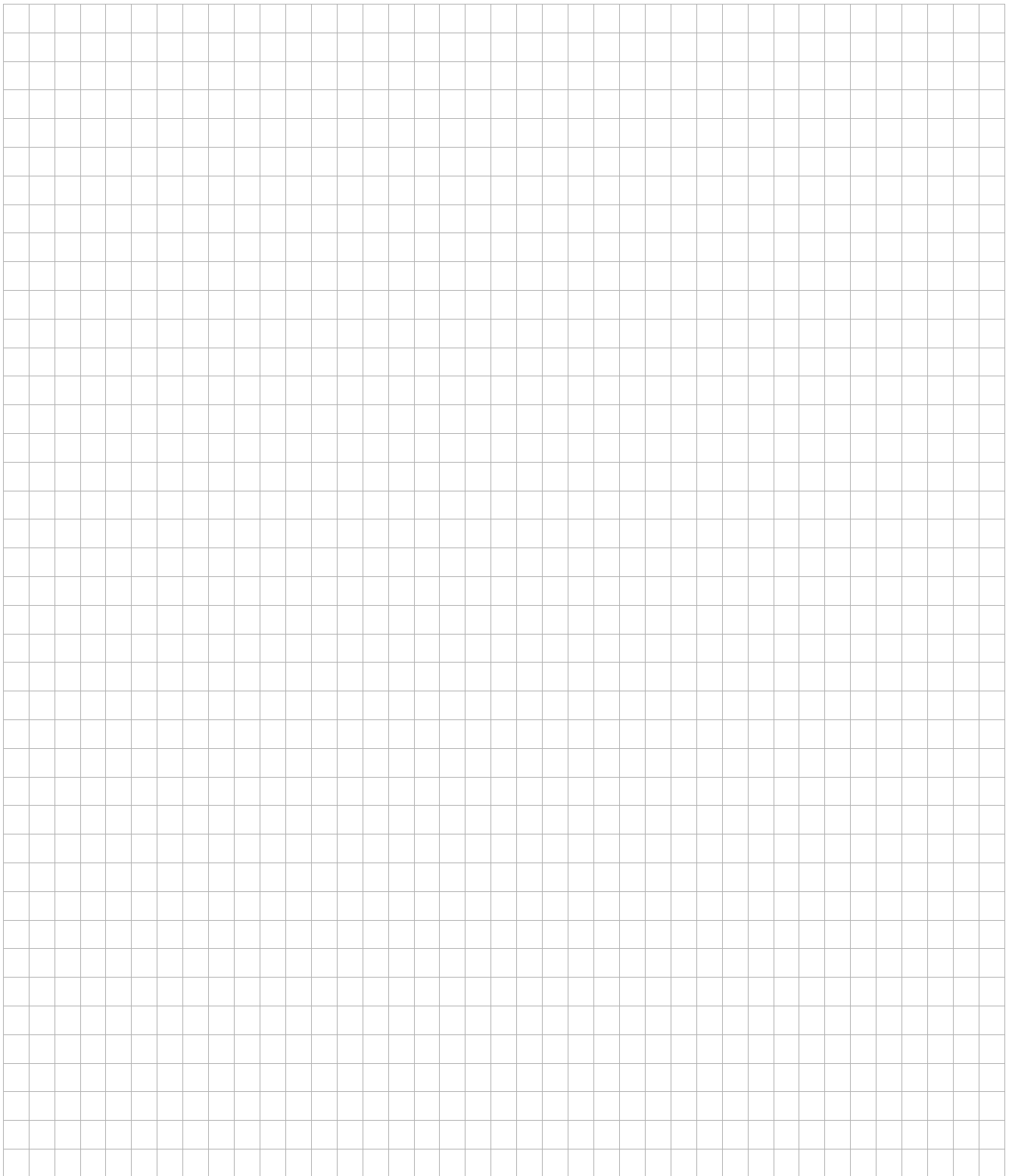

## How we're driving the world

With people who think fast and develop the future with you.



With a worldwide service network that is always close at hand.

With drives and controls that automatically improve your productivity.



With comprehensive knowledge in virtually every branch of industry today.



With uncompromising quality that reduces the cost and complexity of daily operations.



With a global presence that offers responsive and reliable solutions. Anywhere.

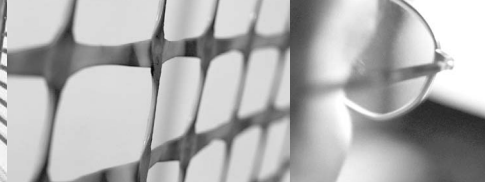

With innovative technology that solves tomorrow's problems today.

With online information and software updates, via the Internet, available around the clock.

**SEW-EURODRIVE**  
Driving the world



**SEW**  
**EURODRIVE**

SEW-EURODRIVE GmbH & Co KG  
P.O. Box 3023 · D-76642 Bruchsal / Germany  
Phone +49 7251 75-0 · Fax +49 7251 75-1970  
sew@sew-eurodrive.com

→ [www.sew-eurodrive.com](http://www.sew-eurodrive.com)