



**EUROTHERM
DRIVES**

650 Series AC Drive

Frame 1, 2 & 3

Product Manual

HA464828U002 Issue A

Compatible with Version 3.x Software

WARRANTY

Eurotherm Drives warrants the goods against defects in design, materials and workmanship for the period of 12 months from the date of delivery on the terms detailed in Eurotherm Drives Standard Conditions of Sale IA058393C.

Eurotherm Drives reserves the right to change the content and product specification without notice.

© Copyright Eurotherm Drives Limited 2002

All rights strictly reserved. No part of this document may be stored in a retrieval system, or transmitted in any form or by any means to persons not employed by a Eurotherm group company without written permission from Eurotherm Drives Ltd.

Although every effort has been taken to ensure the accuracy of this document it may be necessary, without notice, to make amendments or correct omissions. Eurotherm Drives cannot accept responsibility for damage, injury, or expenses resulting therefrom.

Safety Information



IMPORTANT: Please read this information BEFORE installing the equipment.

Requirements

Intended Users

This manual is to be made available to all persons who are required to install, configure or service equipment described herein, or any other associated operation. Information given is intended to highlight safety issues, and to enable you to obtain maximum benefit from the equipment.

Application Area

The equipment described is intended for industrial motor speed control using AC induction or AC synchronous machines.

Personnel

Installation, operation and maintenance of the equipment should be carried out by qualified personnel. A qualified person is someone who is technically competent and familiar with all safety information and established safety practices; with the installation process, operation and maintenance of this equipment; and with all the hazards involved.

Hazards

WARNING!

This equipment can endanger life through rotating machinery and high voltages.

Failure to observe the following will constitute an ELECTRICAL SHOCK HAZARD.

The 400V products in this range are of the Restricted Distribution class according to IEC 61800-3.

In a domestic environment, this product may cause radio interference in which case the user may be required to take adequate measures.

- The equipment must be **permanently earthed** due to the high earth leakage current.
- The drive motor must be connected to an appropriate safety earth.
- The equipment contains high value capacitors which take time to discharge after removal of the mains supply.
- Before working on the equipment, ensure isolation of the mains supply from terminals L1, L2 and L3. Wait for at least 5 minutes for the dc link terminals (DC+ and DC-) to discharge to safe voltage levels (<60V). Measure the DC+ and DC- terminal voltage with a meter to confirm that the voltage is less than 50V.
- Never perform high voltage resistance checks on wiring without first disconnecting drive from the circuit being tested.
- When replacing a drive in an application and before returning to use, it is essential that all user defined parameters for the product's operation are correctly installed.
- This equipment contains electrostatic discharge (ESD) sensitive parts. Observe static control precautions when handling, installing and servicing this product.

IMPORTANT: Metal parts may reach a temperature of 90 degrees centigrade in operation.

Application Risk

The specifications, processes and circuitry described herein are for guidance only and may need to be adapted to the user's specific application. Eurotherm Drives does not guarantee the suitability of the equipment described in this Manual for individual applications.

Risk Assessment

Under fault conditions, power loss or other operating conditions not intended, the equipment may not operate as specified. In particular: ● motor speed may not be controlled ● motor direction may not be controlled ● motor may be energised

Guards

The user must provide guarding and /or additional safety systems to prevent risk of injury and electric shock.

Protective Insulation

All control/signal terminals are SELV, i.e. protected by double insulation. Ensure wiring is rated for highest system voltage. All exposed metalwork in the Inverter is protected by basic insulation and bonding to a safety earth.

Note: Thermal sensors contained within the motor must be double insulated.

RCDs

These are not recommended for use with this product but ,where their use is mandatory, only Type B RCDs should be used.

650 Quick Start

- Mount the drive vertically in a lockable cubicle.
- Is the drive to operate in Local (using the keypad) or Remote Control? If Remote Control, make Control Connections.
- Make power connections. Power-on and follow the Quick Set-Up procedure.
- Apply a small setpoint. Start and stop the motor.

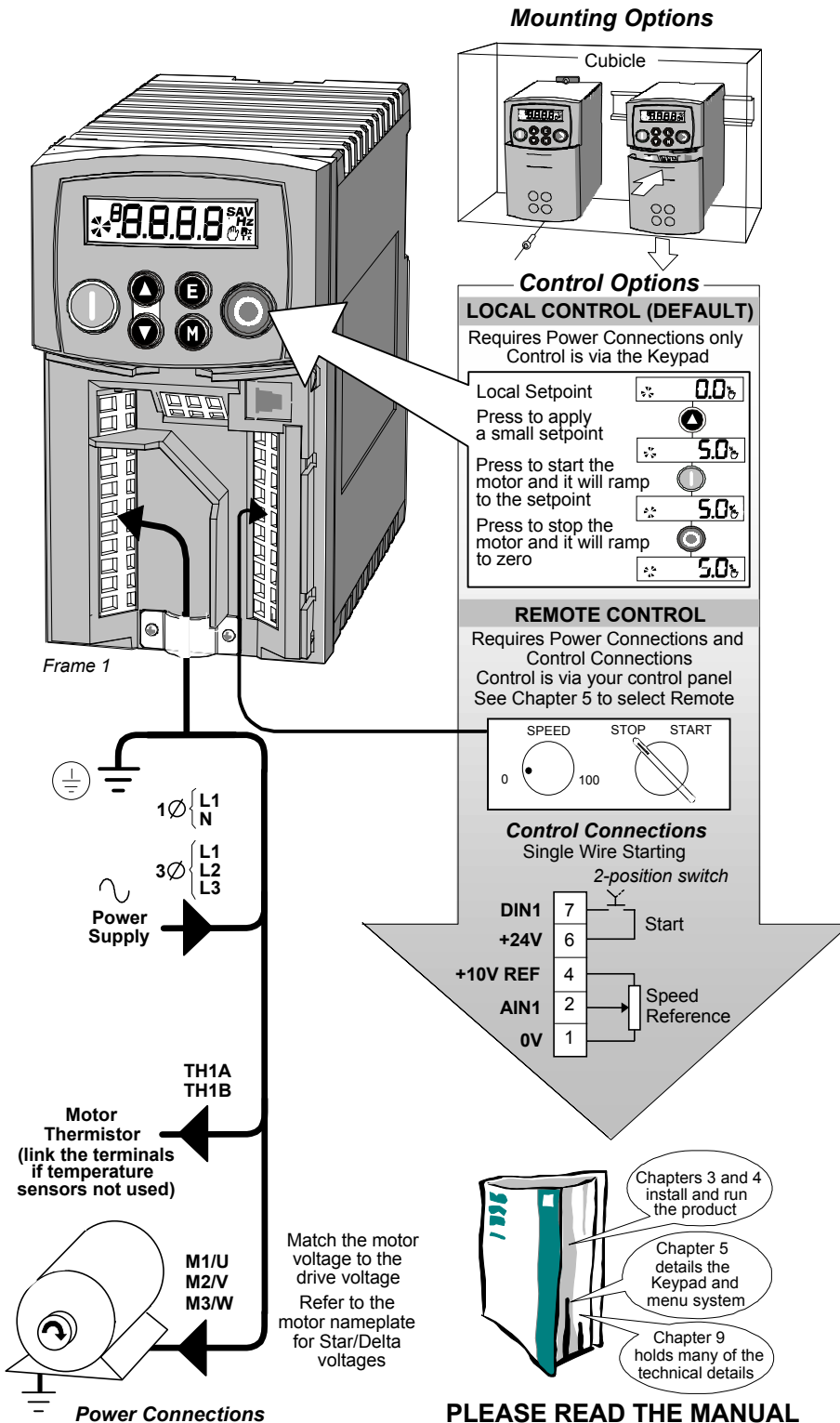

Quick Set-Up

Hold the M key until DIAG is displayed

Navigate to the PAR menu

Press to enter the menu and see the first parameter

Press to show the next parameter

Press to edit the MAX SPEED parameter

Adjust MAX SPEED

Press to exit the parameter

Press (4 times) to show P6

Press to edit the MOTOR CURRENT parameter

Adjust MOTOR CURRENT
Refer to motor nameplate

Press to exit the parameter

Press to show P7

Press to edit the BASE FREQUENCY parameter

Adjust BASE FREQUENCY

Press (3 times) to display the Local Setpoint

POWER-ON

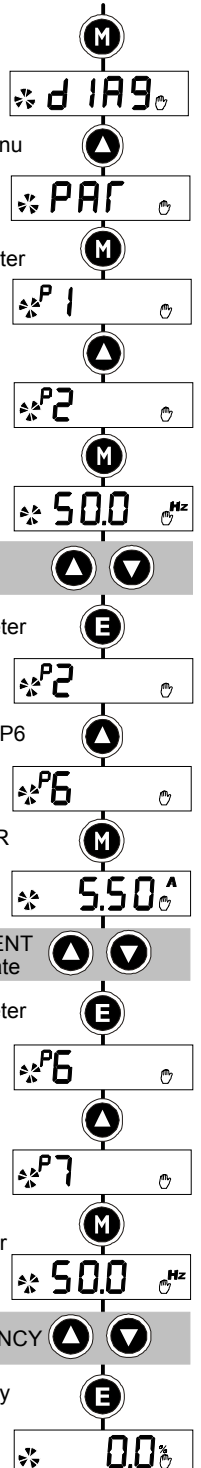

Contents

	<i>Contents</i>	<i>Page</i>
Chapter 1	GETTING STARTED	
	Introduction	1-1
	Equipment Inspection	1-1
	Storage and Packaging	1-1
	About this Manual	1-1
Chapter 2	AN OVERVIEW OF THE DRIVE	
	Component Identification	2-1
Chapter 3	INSTALLING THE DRIVE	
	Mechanical Installation	3-1
	Mounting the Drive	3-1
	Ventilation	3-1
	Electrical Installation	3-2
	Local Control Wiring	3-2
	Remote Control Wiring	3-2
	Connection Diagram.....	3-3
	• Using Cage Clamp Terminals.....	3-4
	• Terminal Block Acceptance Sizes.....	3-4
	• Control Terminal Definitions	3-5
	• Power Terminal Definitions	3-5
	Optional Equipment	3-6
	• Fitting the Remote 6511 RS232 Keypad	3-6
	• Line Choke	3-7
Chapter 4	OPERATING THE DRIVE	
	Pre-Operation Checks.....	4-1
	Start-up Routines	4-1
	Local Control Operation.....	4-2
	Remote Control Operation	4-2
Chapter 5	THE KEYPAD	
	Controlling the Drive using the Keypad	5-1
	Control Key Definitions.....	5-1
	Display Indications	5-2
	Drive Status Indications	5-2
	The DIAGNOSTICS Menu	5-2
	The Menu System	5-3
	How To Change a Parameter Value.....	5-4
	Special Menu Features	5-4
	Resetting to Factory Defaults (2-button reset)	5-4
	Changing the Drive Operating Frequency.....	5-4
	Selecting Local or Remote Control	5-4
	Password Protection	5-5
	Quick Application Selection	5-5
	Selecting the Menu Detail	5-5
Chapter 6	PROGRAMMING YOUR APPLICATION	
	Configurable Parameters	6-1
	• Configuring Terminal 10 (Digital Input/Output)	6-6
	• PID	6-7
	Product-Related Default Values	6-8
	• Frequency Dependent Parameters.....	6-8
	• Power Dependent Parameters.....	6-8

Contents

Contents

Page

Chapter 7 TRIPS AND FAULT FINDING

Trips	7-1
Trip Warning Message	7-1
What Happens when a Trip Occurs	7-1
Resetting a Trip Condition	7-1
Using the Keypad to Manage Trips	7-1
Hexadecimal Representation of Trips	7-3
Fault Finding	7-4

Chapter 8 ROUTINE MAINTENANCE AND REPAIR

Routine Maintenance	8-1
Repair	8-1
Saving Your Application Data	8-1
Returning the Unit to Eurotherm Drives.....	8-1
Disposal	8-1

Chapter 9 TECHNICAL SPECIFICATIONS

Understanding the Product Code	9-1
• Model Number (Europe)	9-1
• Catalog Number (North America)	9-2
Environmental Details	9-3
Power Details	9-3
User Relay	9-3
Electrical Ratings	9-4
Analog Inputs/Outputs	9-5
Digital Inputs	9-5
Digital Outputs	9-5
Cabling Requirements for EMC Compliance	9-5
Internal Dynamic Braking Circuit (400V only)	9-6
External Brake Resistor (400V only)	9-6
Supply Harmonic Analysis (filtered)	9-7
Supply Harmonic Analysis (unfiltered)	9-8

Chapter 10 CERTIFICATION FOR THE INVERTER

Requirements for EMC Compliance	10-1
Earthing Requirements	10-1
Requirements for UL Compliance	10-1
European Directives and the CE Mark	10-3
CE Marking for Low Voltage Directive	10-3
CE Marking for EMC - Who is Responsible?	10-3
EMC Compliance	10-3
Certificates.....	10-4

Chapter 11 SERIAL COMMUNICATIONS

Connection to the P3 Port	11-1
--	-------------

Chapter 12 APPLICATIONS

The Default Application	12-1
How to Load an Application	12-1
Application Description	12-1
Control Wiring for Applications.....	12-1
Application 1 : Basic Speed Control	12-2
Application 2 : Auto/Manual Control	12-3
Application 3 Preset Speeds.....	12-4
Application 4 : Raise/Lower	12-5
Application 5 : PI Control	12-6

GETTING STARTED

Introduction

The 650 Series AC Drive provides simple, compact, and low-cost speed control for 3-phase induction motors.

It operates as an Open-loop Inverter (V/F Fluxing).

This manual describes the low-power end of the 650 product range for the following motor power ratings:

	Nominal Input Voltage	Phase	Drive Power	
Frame 1	230V	1	0.25 – 0.75kW	0.3 - 1.0 Hp
Frame 2	230V	1	1.1 – 1.5kW	1.5 - 2.0 Hp
Frame 2	400V	3	0.37 – 2.2kW	0.5 - 3.0 Hp
Frame 3	200V	3	2.2 – 4.0kW	3.0 - 5.0 Hp
Frame 3	400V	3	3.0 – 7.5kW	4.0 - 10.0 Hp

The drive features:

- Local or Remote mode operation
- SELV control terminals (Safe Extra Low Volts)
- Intelligent monitoring strategy to avoid nuisance tripping
- In-built protection of the unit against overloads, excessive voltages, phase-to-phase and phase-to-earth short circuits
- An optional internal RFI filter offering full electromagnetic compatibility (EMC) for the majority of applications
- An internal dynamic brake switch for connection to an external resistor (400V units only)
- Quiet operation

Equipment Inspection

- Check for signs of transit damage
- Check the drive is suitable for your requirements by reading the Product Code on the rating label. Refer to Chapter 9: “Technical Specifications” - Understanding the Product Code.

If the unit is damaged, refer to Chapter 8: “Routine Maintenance and Repair” for information on returning damaged goods.

Storage and Packaging

Save the packaging in case of return. Improper packaging can result in transit damage.

If the unit is not being installed immediately, store the unit in a well-ventilated place away from high temperatures, humidity, dust or metal particles.

About this Manual

This manual is intended for use by the installer, user and programmer of the drive. It assumes a reasonable level of understanding in these three disciplines.

Note: Please read all Safety Information before proceeding with the installation and operation of this unit.

It is important that you pass the manual on to any new user of this unit.

AN OVERVIEW OF THE DRIVE

Component Identification

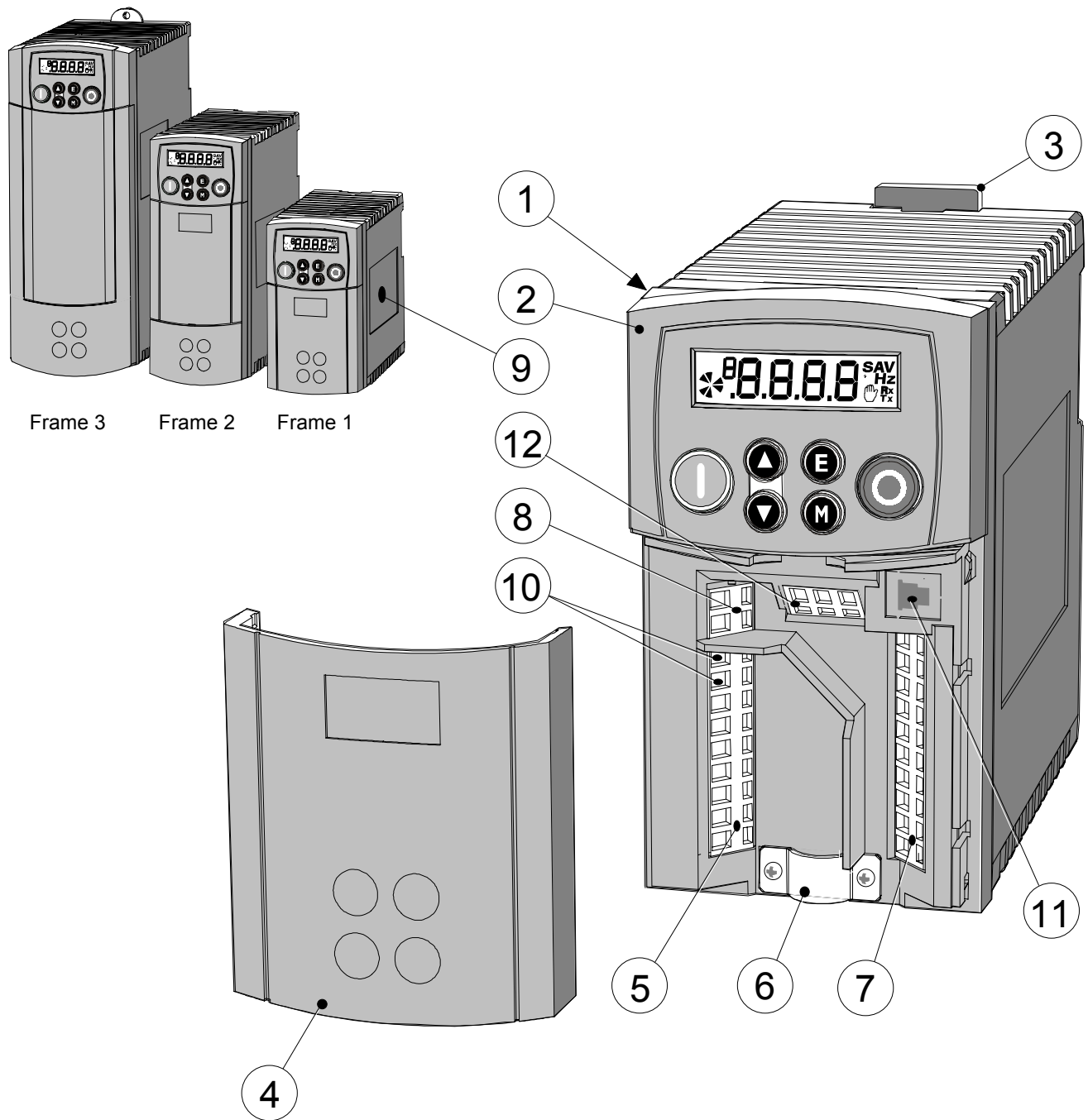

Figure 2-1 View of Component Parts (Frame 1 illustrated)

1	Main drive assembly	7	Control terminals
2	Keypad	8	Volt-free relay contacts
3	DIN clip/fixing bracket	9	Product rating label
4	Terminal cover	10	Motor thermistor terminals
5	Power terminals	11	RS232 programming port - P3 (optional)
6	Motor cable screen clamp	12	Encoder/digital inputs (optional)

INSTALLING THE DRIVE

IMPORTANT: Read Chapter 10: "Certification for the Drive" before installing this unit.

Mechanical Installation

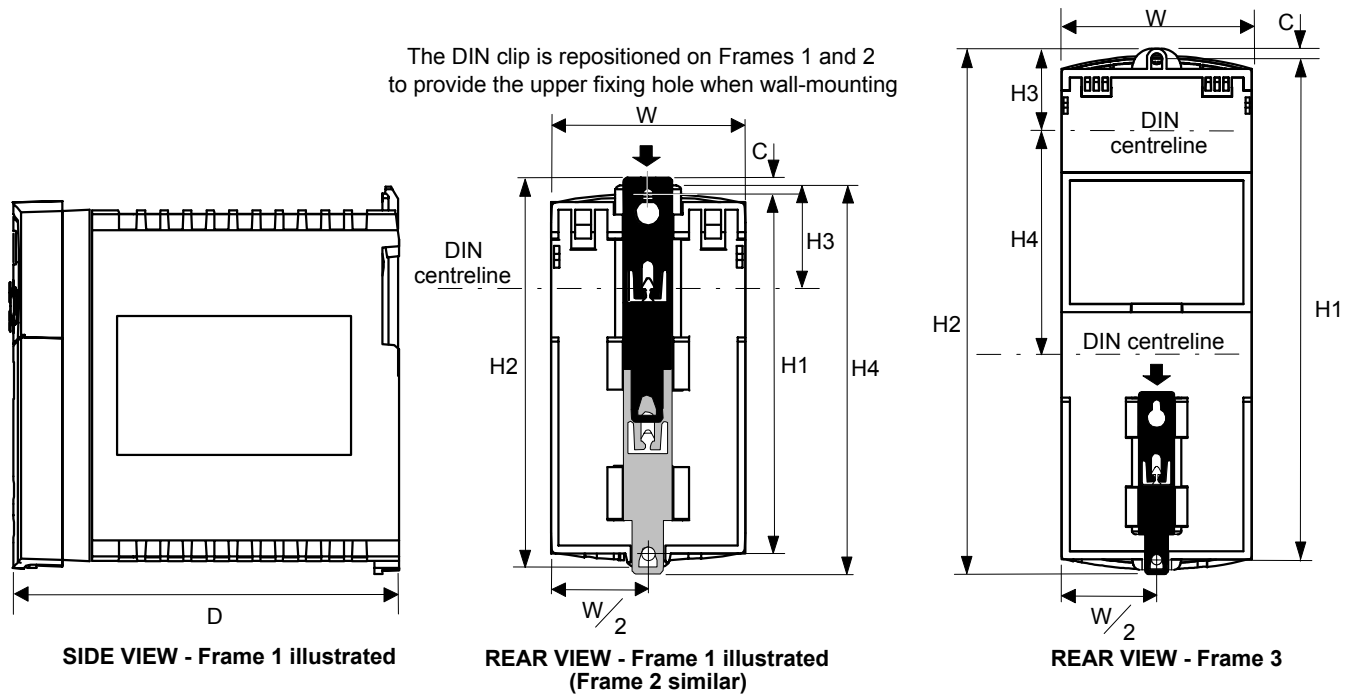

	Fixing	Torque	Weight	H1 Fixing Centres	H2	H3	H4	C	W	D
Frame 1	M4	1.5Nm	0.85kg	132 (5.2")	143 (5.6")	35 (1.4")	139 (5.5")	6 (0.2")	73 (2.9")	142 (5.6")
Frame 2	M5	3.0Nm	1.4kg	188 (7.4")	201 (7.9")	35 (1.4")	194 (7.7")	6.5 (0.24")	73 (2.9")	173 (6.8")
Frame 3	M5	3.0Nm	2.7kg	242 (9.5")	260 (10.2")	38 (1.5")	112 (4.4")	5 (0.2")	96 (3.8")	200 (7.9")

Dimensions are in millimetres (inches)

Mounting the Drive

To maintain compliance with European Electrical Safety Standard VDE0160(1994)/EN50178 (1998) the unit must be mounted inside a control cubicle that requires a tool for opening. The cubicle should provide 15dB attenuation to radiated emissions between 30-100MHz.

Mount the drive vertically on a solid, flat, non-flammable, vertical surface. It can be panel-mounted, or rail-mounted on a rail complying with EN50022 (35mm DIN).

DIN Mounting

To DIN mount the unit, hang the unit on the top DIN rail and push the unit onto the bottom DIN rail until it snaps in to position. Secure with a lower screw fixing. To release the unit, use a flat bladed screwdriver as shown.

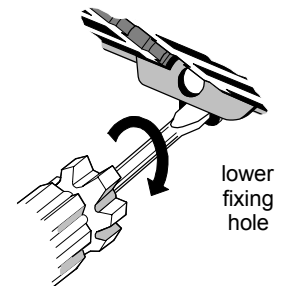

Ventilation

Maintain a minimum air clearance for ventilation of 100mm (4 inches) above and below the unit. When mounting two or more 650 units together, these clearances are additive. Ensure that the mounting surface is normally cool. Be aware that adjacent equipment may generate heat and also have clearance requirements. Provided the minimum clearance for ventilation is maintained, 650 drives may be mounted side-by-side.

3-2 Installing the Drive

Electrical Installation

IMPORTANT: Read the Safety Information on page Cont. 2 before proceeding.

Local Control Wiring

This is the simplest installation. Every new drive will operate in Local Control when first powered-up. The keypad is used to start and stop the drive.

Refer to the Connection Diagram and install the:

- Thermistor cable, or link/jumper terminals TH1A and TH1B if not used (we recommend you use a thermistor)
- Motor cable
- Supply cable
- Follow the earthing/grounding and screening advice

Refer to Chapter 4: "Operating the Drive"- Local Control Operation.

Minimum Connections

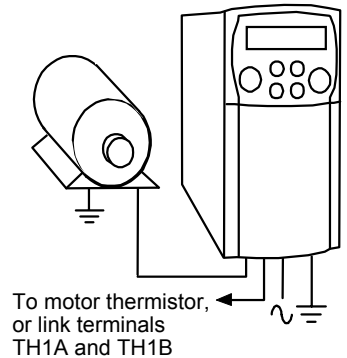

Remote Control Wiring

If operating in Remote Control you will use your control panel to start and stop the drive, via a speed potentiometer and switches or push-buttons.

Your wiring of the control terminals will be governed by the Application you use: refer to Chapter 12 for an explanation of the various Applications you can select and the appropriate control wiring. Application 1 is the default Application.

The diagram below shows the **minimum** connections to operate the drive for single-wire starting (switch), and push-button starting. Other control connections for your Application, shown in Chapter 12, can be made to suit your system.

- Install as above, for Local Control Wiring
- Refer to Chapter 12 and install control wiring for your system

Minimum Connections

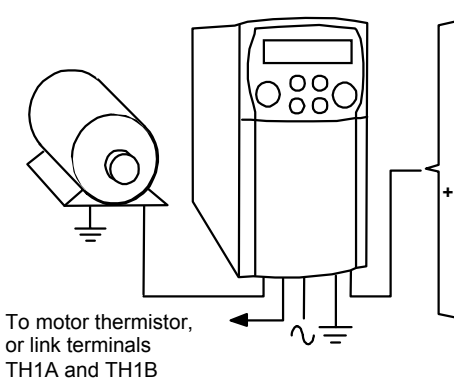

Single Wire Starting
(All Applications)

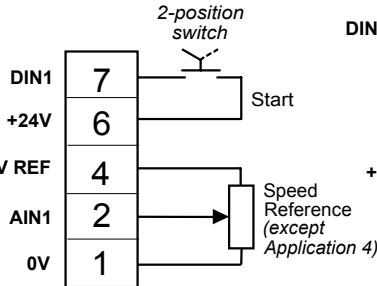

Push-Button Starting
(Applications 1 & 5 only)

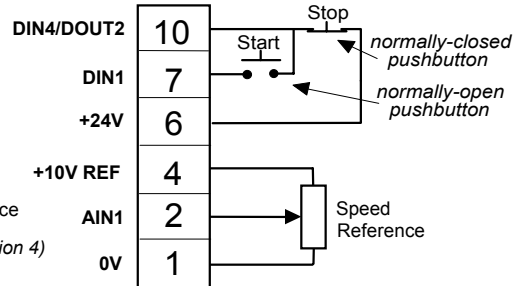

Note: You can still operate the drive in Local mode, if necessary, with any Application selected.

Refer to Chapter 4: "Operating the Drive" and follow the relevant instructions for Single Wire Starting or Push-Button Starting.

WARNING!

This product is designated as "professional equipment" as defined in EN61000-3-2. Where enforced, permission of the supply authority shall be obtained before connection to the low voltage domestic supply.

Ensure that all wiring is electrically isolated and cannot be made "live" unintentionally by other personnel.

The drive is only suitable for use with earth referenced supplies (TN) when fitted with an internal ac supply EMC filter.

Connection Diagram

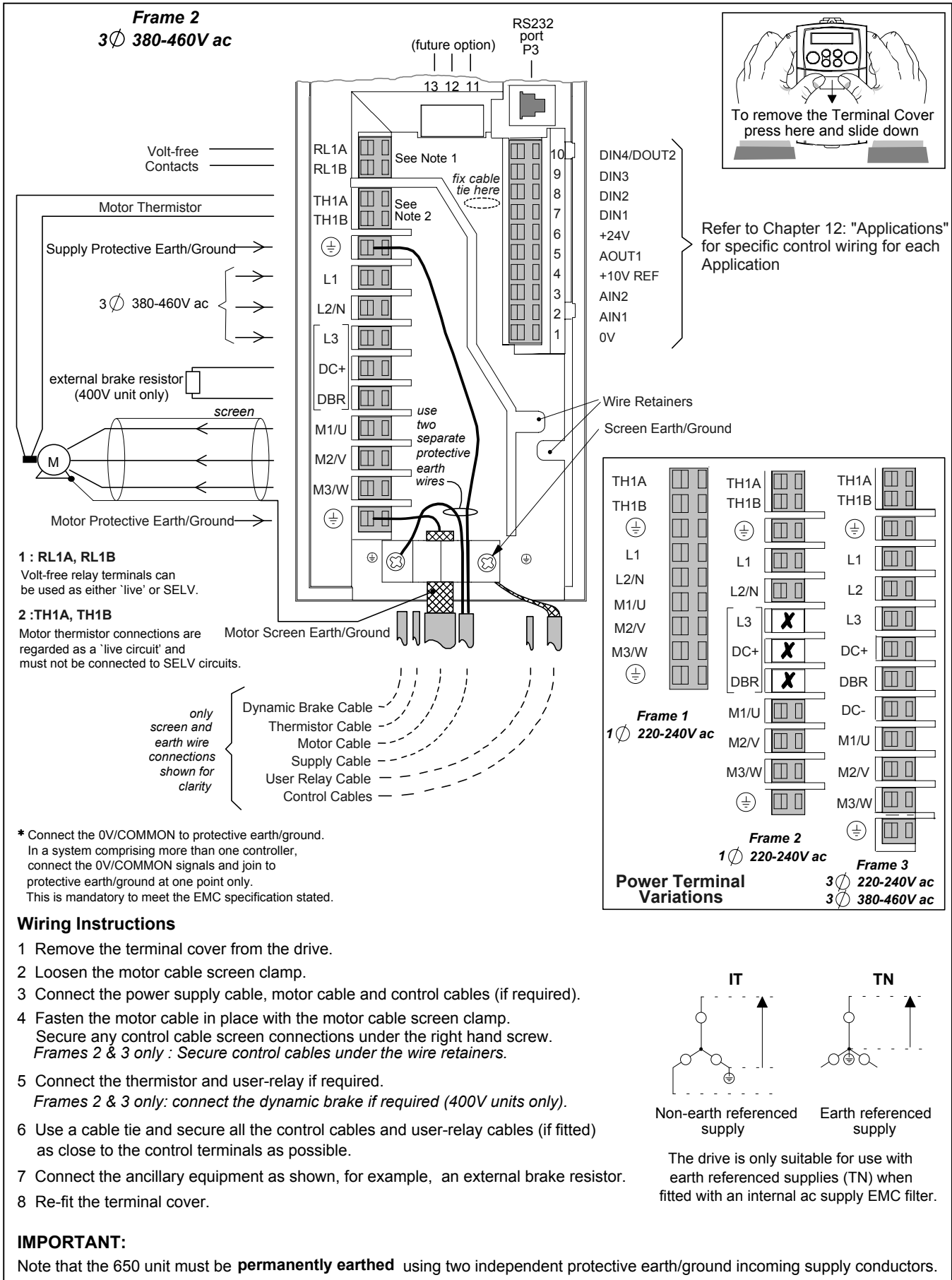

3-4 Installing the Drive

Using Cage Clamp Terminals

Strip wire insulation to 5-6mm (0.20-0.24 inches), or alternatively use wire-crimps. Use a flat-bladed screwdriver, maximum blade size 3.5mm. The cage provides the correct force for a secure connection.

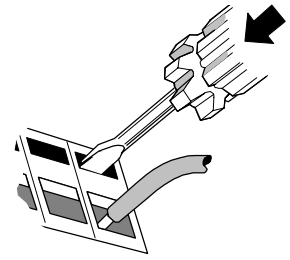

IMPORTANT: DO NOT lever or turn the screwdriver.

Terminal Block Acceptance Sizes

Wire sizes should be chosen with respect to the operating conditions and your local National Electrical Safety Installation Requirements. Local wiring regulations always take precedence.

Frame Size	Power Terminals (maximum wire size)	Brake Terminals (maximum wire size)	Thermistor/Control Terminals (maximum wire size)
Frame 1	2.5mm ² /12 AWG	Not Applicable	2.5mm ² /12 AWG
Frame 2 200V	2.5mm ² /12 AWG	Not Applicable	2.5mm ² /12 AWG
Frame 2 400V	2.5mm ² /12 AWG	2.5mm ² /12 AWG	2.5mm ² /12 AWG
Frame 3 200V & 400V	6.0mm ² /10 AWG	6.0mm ² /10 AWG	2.5mm ² /12 AWG

Power Wiring

Note: For specified EMC emission and immunity performance, install to EMC Installation Instructions. Refer to Chapter 10: "Certification for the Drive" - for more information

Protect the incoming mains supply using the specified fuse, or RCD circuit breaker Type B.

IMPORTANT: We do not recommend the use of circuit breakers (e.g. RCD, ELCB, GFCI), however, where their use is mandatory, they must:

- Operate correctly with dc and ac protective earth currents (i.e. type B RCDs as in Amendment 2 of IEC755).
- Have adjustable trip amplitude and time characteristics to prevent nuisance tripping on switch-on.

Control Wiring



Control wiring of between 0.08mm² (28AWG) and 2.5mm² (12AWG) can be used. Ensure all wiring is rated for the highest system voltage. All control terminals are SELV, i.e. double-insulated from power circuits.

Control Terminal Definitions

Terminal (SELV)	Description	Application 1 Default Function (for other Applications refer to Chapter 12: "Applications")	Range
P3	P3	RS232 port for use with remote-mounted RS232 keypad	-
RL1A	User Relay	Volt-free contact	0-250Vac/24Vdc 6A
RL1B	User Relay	Volt-free contact	0-250Vac/24Vdc 6A
10	DIN4/ DOUT2	Configurable digital input/output Not Stop (input): 0V = No latching of Run (DIN1), 24V = Run latched	0-24V source open collector 50mA maximum
9	DIN3	Jog – configurable digital input: 0V = Stop, 24V = Jog	0-24V
8	DIN2	Direction – configurable digital input: 0V = Forward, 24V = Reverse	0-24V
7	DIN1	Run – configurable digital input: 0V = Stop, 24V = Run	0-24V
6	+24V	24V – 24V supply for digital I/O	50mA maximum
5	AOUT1	Ramp Output – configurable analog output (10mA loading)	0-10V
4	10VREF	10V - 10V reference (10mA maximum loading)	10V
3	AIN2	Feedback – analog input 2	0-10V, 4-20mA
2	AIN1	Setpoint – analog input 1	0-10V
1	0V	0V - 0V reference for analog/digital I/O	0V

Power Terminal Definitions

IMPORTANT: * Units fitted with a filter must use an earth referenced supply (TN).

Terminal	Description	Function	Range	
			200V 1-Phase	400V 3-Phase
TH1A	Thermistor	Connection to motor thermistor	It is good practice to protect motors by fitting temperature sensitive resistors. A typical resistance (up to a reference temperature of 125°C) is 200Ω, rising rapidly to 2000Ω above this temperature. Connect devices in series between TH1A and TH1B. Link the terminals if temperature sensors are not used.	
TH1B	Thermistor	Connection to motor thermistor		
	Reference Terminal	Supply protective earth (PE). This terminal must be connected to a protective (earth) ground for permanent earthing .		
L1	Power Input	Single and three phase live connection	220/240V ac ±10% rms with respect to L2/N. 50-60Hz (IT/TN)*	380/460V ac ±10% rms with respect to L2, L3 phase-to-phase. 50-60Hz (IT/TN)
L2/N L2	Power Input	Single phase neutral (or L2 three phase live connection)	220/240V ac ±10% with respect to L1. 50-60Hz (IT/TN)*	380/460V ac ±10% with respect to L1, L3. 50-60Hz (IT/TN)*
L3	Power Input	Three phase live connection	Not applicable	380/460V ac ±10% with respect to L1, L2. 50-60Hz (IT/TN)*
DC-	<i>No user connection</i>			
DC+	Dynamic Brake	Connection to external brake resistor	Not applicable	Frame 2 (high volt only) & 3. See "Internal Dynamic Brake Switch" table
DBR	Dynamic Brake	Connection to external brake resistor	Not applicable	Frame 2 (high volt only) & 3. See "Internal Dynamic Brake Switch" table
M1/U M2/V M3/W	Motor Outputs	Connection for motor	Motor rated at: 0 to 220/240V ac 0 to 240Hz	Motor rated at: 0 to 380/460V ac 0 to 240Hz
	Reference Terminal	Supply protective earth (PE). This terminal must be connected to a protective (earth) ground for permanent earthing .		

3-6 Installing the Drive

Optional Equipment

Two types of keypad are available:

Eurotherm Part No. 6511/DISP/... not suitable for remote-mounting

Eurotherm Part No. 6511/DISPR/... suitable for remote-mounting on drives with an RS232 port

Both types can be fitted to the front of any 650 drive. However, not all drives are fitted with the RS232 (P3) port required for remote-mounting the Remote Keypad. Refer to Chapter 9:

"Technical Specifications" - Understanding the Product Code.

Fitting the Remote Keypad

You can remote-mount the drive-mounted keypad using:

- a Remote Keypad (identified by the RS232 connector on the back)
- the RS232 (P3) port located under the terminal cover

A standard P3 lead, Eurotherm Part Number CM057375U300, is used to connect the keypad to the drive.

Two self-tapping screws are provided with the keypad. Remove the protective film from the gasket. An enclosure rating of IP54 is achieved for the remote keypad when correctly mounted.

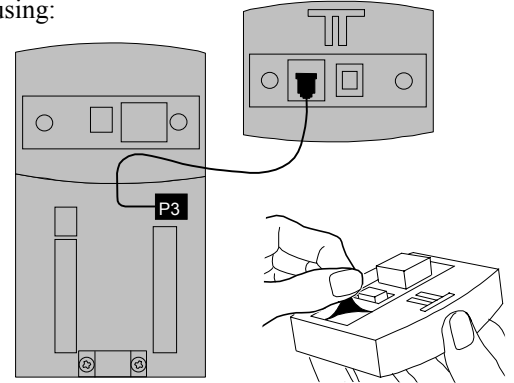

Assembly Procedure

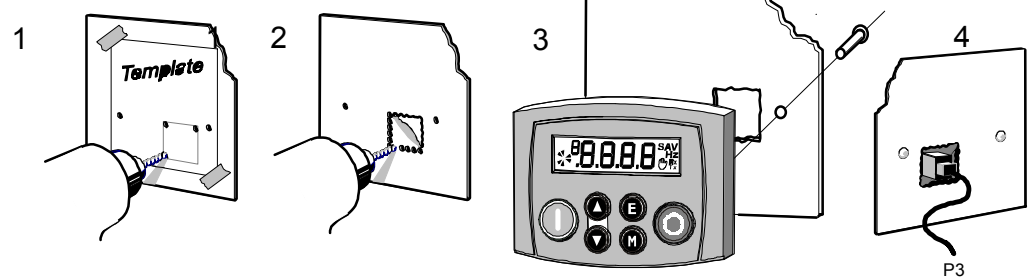

Cut-out Dimensions

The drawing below can be photocopied actual size (100%) and used as a template.

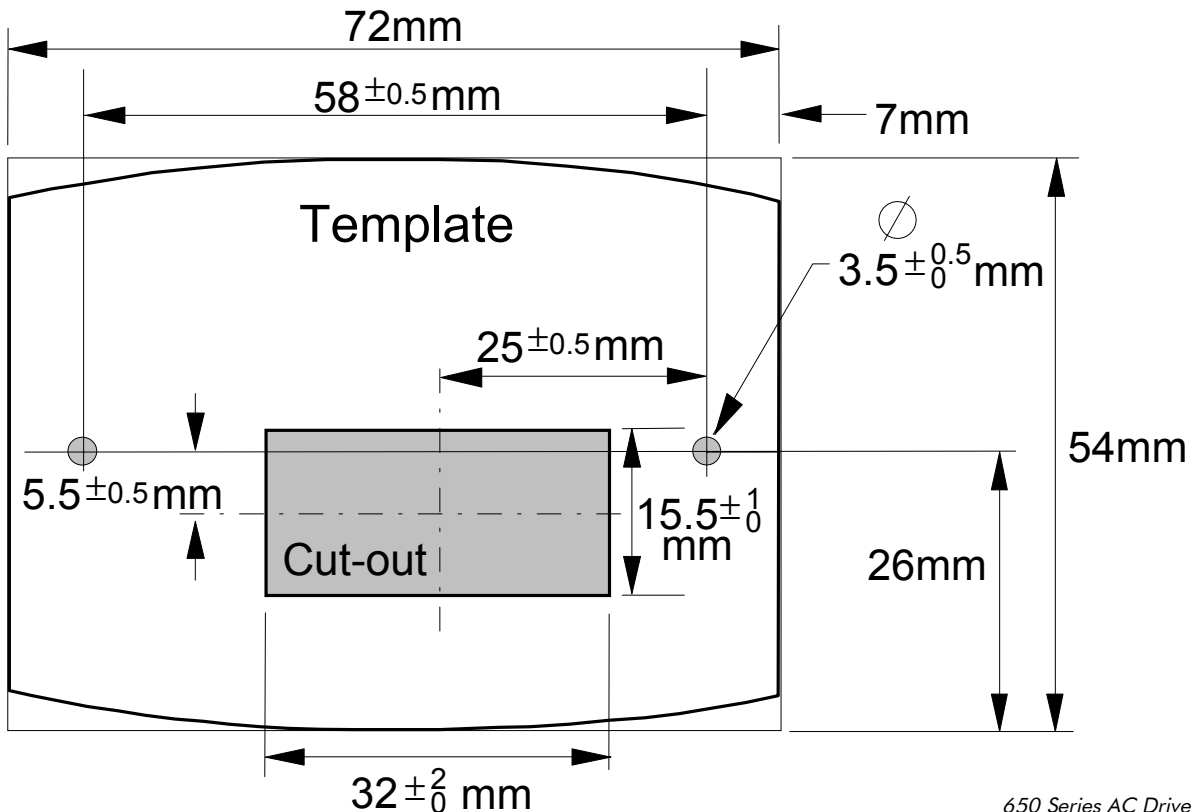

Line Choke

This line choke is used to reduce harmonic emission to meet the limits of EN61000-3-2. The following cables are considered to be electrically sensitive, clean or noisy:

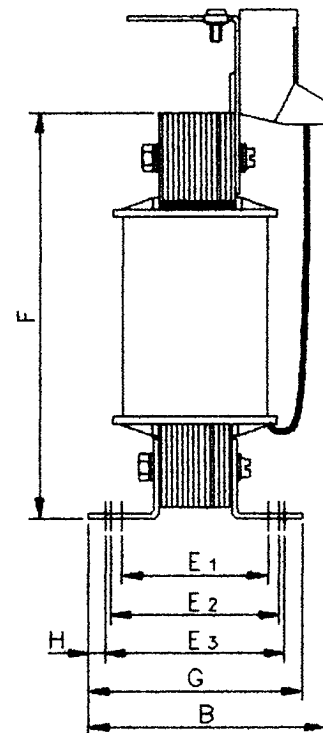
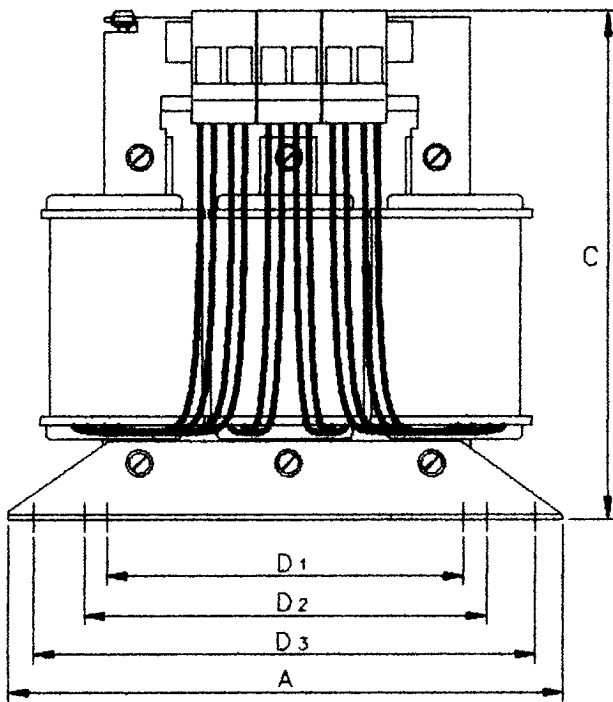
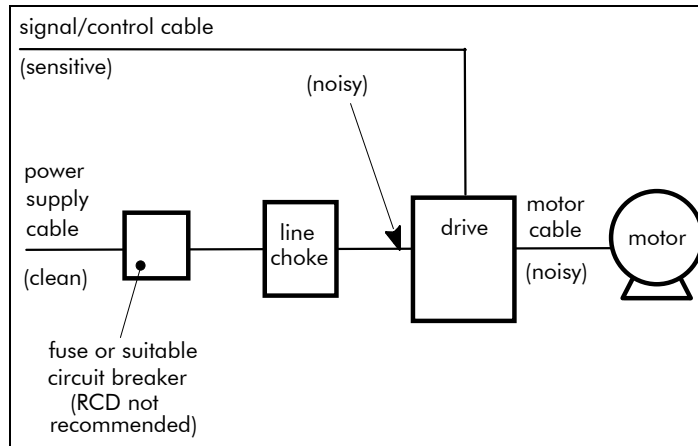

Rated Current (A _{eff})	Rated Inductivity (mH)	A (mm)	B	C	D1	D2	D3	E1	E2	E3	F*	G	Fixing Screws	Weight (kg/lbs)
650 Frame 2, 3-phase, 400V, 0.37kW/0.5Hp														
6	4.88	148	76	151	90	100	136	39	45	49	110	69	M4	2.1/

* dimension is dependent of the air gap

3-8 Installing the Drive

OPERATING THE DRIVE

Pre-Operation Checks

WARNING!

Wait for 5 minutes after disconnecting power before working on any part of the system or removing the terminal cover from the drive.

Initial checks before applying power:

- Check for damage to equipment.
- Mains power supply voltage is correct.
- Motor is of correct voltage rating and is connected in either star or delta, as appropriate.
- Check all external wiring circuits - power, control, motor and earth connections.

Note: Completely disconnect the drive before point to point checking with a buzzer, or when checking insulation with a Meggar.

- Check for loose ends, clippings, drilling swarf etc. lodged in the drive and system.
- If possible check that the motor can be turned freely, and that any cooling fans are intact and free from obstruction.

Ensure the safety of the complete system before the drive is energised:

- Ensure that rotation of the motor in either direction will not cause damage.
- Ensure that nobody else is working on another part of the system which will be affected by powering up.
- Ensure that other equipment will not be adversely affected by powering up.

Prepare to energise the drive and system as follows:

- Remove the supply fuses, or isolate using the supply circuit breaker.
- Disconnect the load from the motor shaft, if possible.
- If AIN1 terminal is not used, tie the terminal high (+24V).
- If terminals TH1A and TH1B are not connected to a motor thermistor, connect these terminals together.
- Check external run contacts are open. Check external speed setpoints are all zero.

Re-apply power to the drive and system

Start-up Routines

Note: Refer to Chapter 5: "Using the Keypad" to familiarise yourself with the keypad's indications, and how to use the keys and menu structure.

The drive can be started in either Remote Control or Local Control. By default, the drive will start in Local Control.

These routines assume that the drive's control terminals are wired as shown in the Connection Diagram in Chapter 3.

Connected in this way, a positive setpoint will rotate the motor in a clockwise direction when viewed down the shaft, looking toward the motor.

Note: If during the start-up routine the display shows either an alarm (indicated by the letter "A") or a flashing Warning message, refer to Chapter 7: "Trips and Fault Finding".



A typical alarm

4-2 Operating the Drive

Local Control Operation

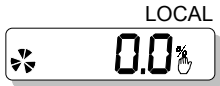

Connect the keypad to the drive and power-up the unit.

The drive will display the Local screen. If not, refer to Chapter 5 and select Local Control.

Follow the instructions opposite to start and stop the motor.

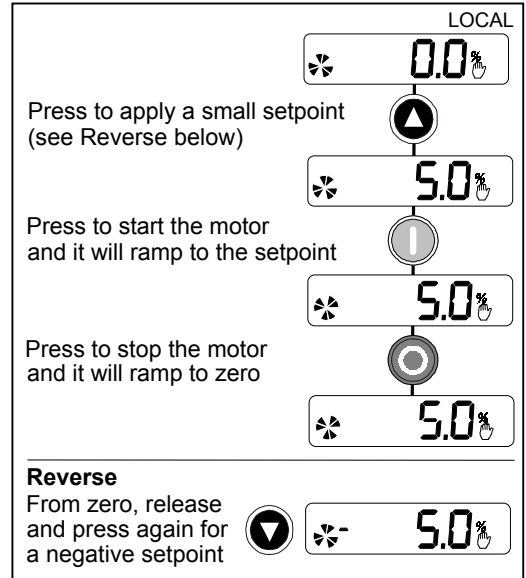

Remote Control Operation



Connect the keypad to the drive and power-up the unit.

The drive will display the Local screen. Refer to Chapter 5 and select Remote Control.

Check that the speed potentiometer is set to zero.

Follow the instructions below to start and stop the motor using your control panel.

Reverse the motor's direction of rotation using the DIN2 connection (0V = forward, +24V = reverse). Alternatively, swap two of the motor phases (**WARNING: Disconnect the mains supply first**).

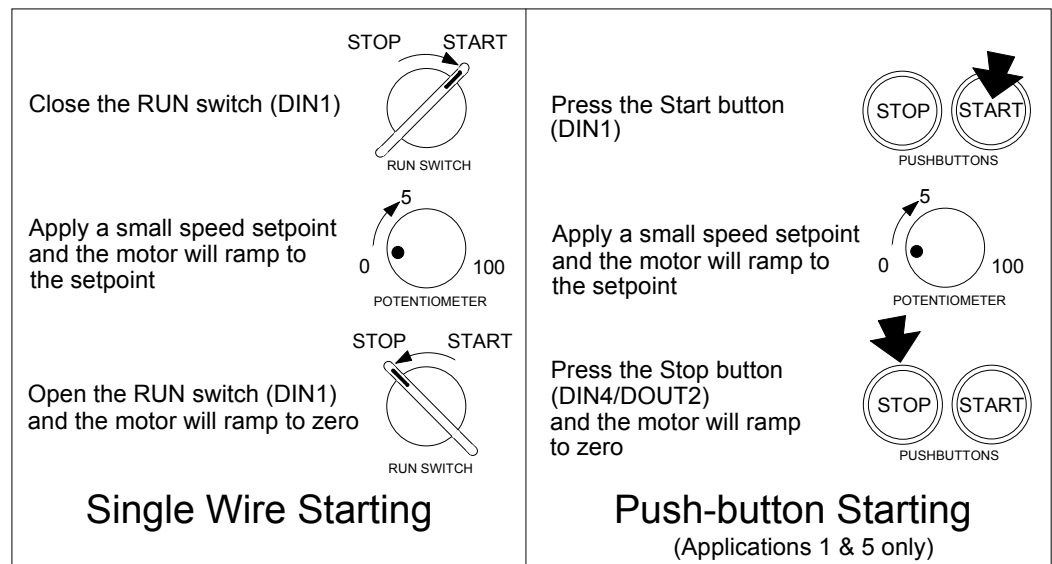

The installation of your drive is now complete:

The drive will operate as an open-loop drive. It is programmed to control an induction motor of equivalent power, current, and voltage rating to the drive. The drive's default parameters will operate effectively under most circumstances, however you may wish to refer to Chapter 6 to tune the drive to your system.

THE KEYPAD

The keypad (Man-Machine Interface, MMI) provides for local control of the drive, monitoring, and complete access for application programming.

The 650 can be fitted with either a Standard or Remote Keypad. Both keypads fit on the front of the drive, but the Remote Keypad (with its extra connector) can also be remote-mounted up to 3 metres away using a connecting lead: refer to Chapter 3: “Installing the Drive” – Fitting the Remote Keypad.

To remove a keypad, simply pull it away from the drive. To refit it, push it back into place.

The product rating label identifies the drive/keypad type: refer to Chapter 9: “Technical Specifications” – Understanding the Product Code.

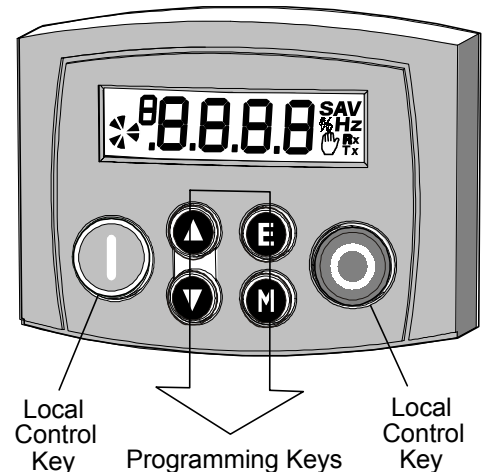

The Power-Up Condition

On initial power-up, direct from the factory, the drive is in Local Control and the MMI will display the Local Setpoint, **0.0** Hz.

All parameters will be at factory default settings. Any changes to these conditions are automatically saved. The drive will initialise on subsequent power-ups with the previously saved settings and control mode, Local or Remote Control.

Controlling the Drive using the Keypad

Control Key Definitions

Key	Operation	Description
	Escape	<i>Navigation</i> – Displays the previous level’s menu <i>Parameter</i> – Returns to the parameter list <i>Trip Display</i> – Removes Trip or Error message from display allowing investigation of parameters
	Menu	<i>Navigation</i> – Displays the next menu level, or the first parameter of the current Menu <i>Parameter</i> – Moves cursor to the left when the parameter is adjustable
	Increment	<i>Navigation</i> – Move upwards through the menu system <i>Parameter</i> – Increase value of the displayed parameter <i>Local Mode</i> – Increase value of the local setpoint
	Decrement	<i>Navigation</i> – Move down through the menu system <i>Parameter</i> – Decrease value of the displayed parameter <i>Local Mode</i> – Decrease value of the local setpoint
	Run	<i>Local Mode</i> – Run the drive <i>Trip Reset</i> – Resets trip condition allowing drive to resume operation
	Stop	<i>Local Mode</i> – Stops the drive. Trip Reset in all modes <i>Navigation</i> – Press and hold to toggle between Local and Remote Control modes (refer to page 5.4) <i>Trip Reset</i> – Resets trip condition allowing drive to resume operation

5-2 The Keypad

Display Indications

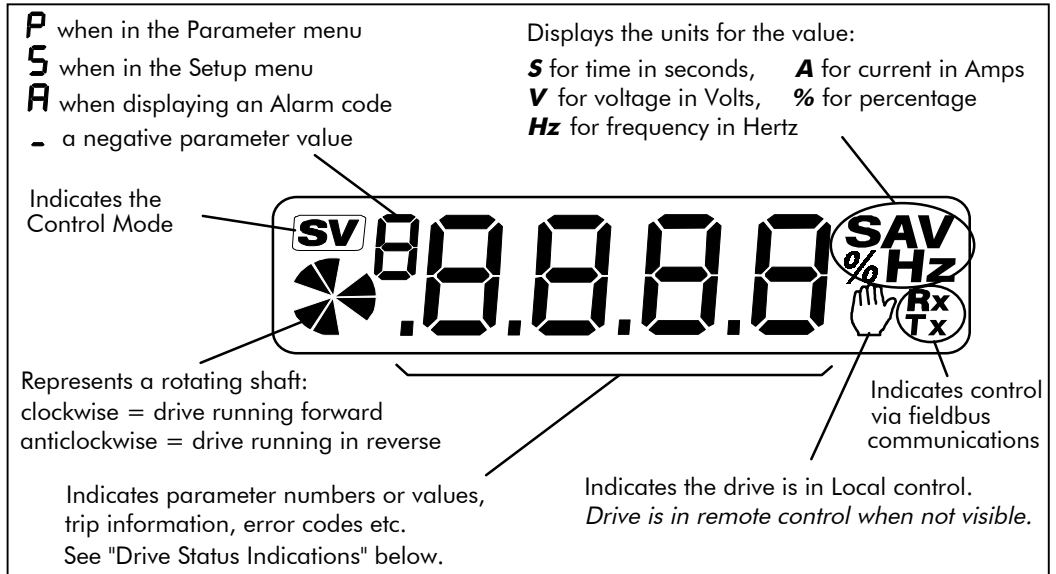

Drive Status Indications

The keypad can display the following status information:

Display	Status Indication and Meaning	Possible Cause
rdy	READY/HEALTHY No alarms present. Remote mode selected	
PASS	PASSWORD Current password must be entered before this parameter may be altered.	Enter password to change the parameter. Refer to page 5.5
LOC	LOCAL Local Control selected, healthy, no alarms present	Added or removed from the display letter-by-letter to indicate entering or leaving Local Control

The DIAGNOSTICS Menu

Display	Name	Description
0.0 Hz	FREQUENCY	The current output frequency in Hertz
0.0%	SPEED SETPOINT	The set point as a percentage of MAX SPEED
0.0 V	DC LINK VOLTS	$V_{ac} (rms) \times \sqrt{2} =$ dc link Volts (when motor stopped)
0.0 A	MOTOR CURRENT	The current load value in Amps

The Menu System

The menu system is divided into a “tree” structure with 3 menu levels.

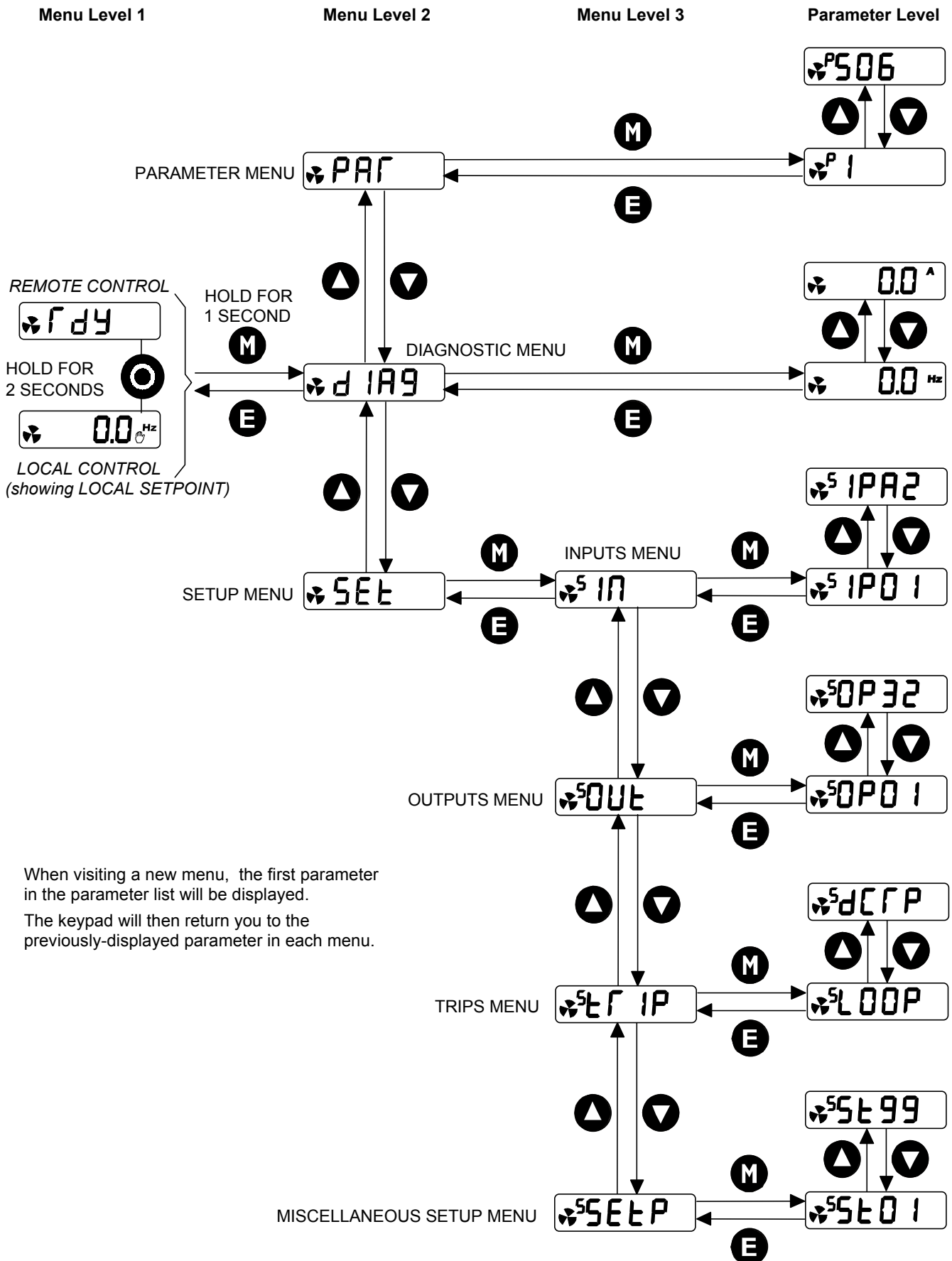





When visiting a new menu, the first parameter in the parameter list will be displayed. The keypad will then return you to the previously-displayed parameter in each menu.

5-4 The Keypad

How To Change a Parameter Value

You can change the values of parameters stored in the **PRF** and **SEt** menus. Refer to Chapter 6: “Programming Your Application” – Configurable Parameters for further information.

- View the parameter to be edited and press  to display the parameter’s value.
- Select the digit to be changed (pressing the  key moves the cursor from right to left).
- Use the   keys to adjust the value. Hold the key momentarily to adjust the value marginally, or hold the key to make rapid changes; the rate of change varies with the time held.
- Press  to return to the parameter display. The new value is stored.

Special Menu Features

Resetting to Factory Defaults (2-button reset)

Power-up the drive whilst holding the keys as shown to return to factory default settings.

This loads Application 1. Then press the  key.

Hold down the keys opposite:
Power-up the drive, continue to hold for at least 1 second

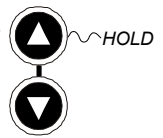





Changing the Drive Operating Frequency

Power-up the drive whilst holding the keys as shown to display the Engineers Menu.

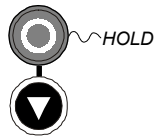
IMPORTANT: This menu contains sensitive parameters that can dramatically alter the running of the drive.

Hold down the keys opposite:
Power-up the drive, continue to hold for at least 1 second



This displays parameter ^E0.01. Press the  key to navigate to ^E0.02. Press the  key to edit the parameter: 0 = 50Hz (default), 1 = 60Hz. Select the required frequency then press the  key.

Power-down the drive. No permanent change has been made to the drive at this point. To save the change to parameter ^E0.02, you must now perform a 2-button reset (as above). Please note that this will return the drive to its factory default settings for the selected default frequency.

Selecting Local or Remote Control

The drive can operate in one of two ways:

- | | |
|------------------------|---|
| Remote Control: | Allowing access for application programming using digital and analog inputs and outputs |
| Local Control: | Providing local control and monitoring of the drive using the Keypad |

Local control keys are inactive when Remote Control is selected.

In Remote Control, the drive uses a remote setpoint. In Local Control, it uses the Local Setpoint parameter whose value is adjusted on the MMI.

Note: You can only change between Local and Remote Control when the drive is “stopped”, and either  or the Local Setpoint is displayed.

Remote to Local Control:

Hold this key down until the display shows 

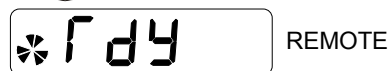

Hold this key down until the display spells 



Release the key to display the Local Setpoint



Local to Remote Control:

View the Local Setpoint



LOCAL

Hold this key down until **LDC** is removed from the display



Release the key to display



REMOTE

Note: For safety reasons, the drive will not return to Remote Control if this will cause the drive to start. Check RUN and JOG inputs are low.

Password Protection

When activated, the password prevents unauthorised parameter modification by making all parameters “read-only”. Password protection is set-up using the **P 99** parameter.

Steps	ACTIVATE		TEMPORARY DE-ACTIVATION		REMOVE PASSWORD	
	Actions	Display	Actions	Display	Actions	Display
1	Go to P 99 Press M	0000	Try to edit any parameter with password activated	PASS → 0000	Go to P 99 Press M	PASS → 0000
2	Enter new password using ▲ ▼	0001 for example	Enter current password using ▲ ▼	0001 for example	Enter current password using ▲ ▼	0001 for example
3	Press E repeatedly until top of menu is reached	rdy, Remote Setpoint or Local Setpoint	Press E	Original parameter displayed, password de-activated	Press E Reset to 0000 using ▲ ▼	0000
4	Press E to activate password	rdy, Remote Setpoint or Local Setpoint	A drive will power-up with the last password status. Temporary de-activation is lost on power-down.		Press E to remove password	P 99
	Default = 0000, de-activated Any other value is a password					

Quick Application Selection

You can navigate immediately to the APPLICATION parameter, **P1**, from power-up, as shown opposite.

Hold down the key opposite:
Power-up the drive, continue to hold for at least 1 second



Then, press the **M** key to display the current Application. Press again to allow the parameter to be changed.

Use the **▲** **▼** keys to select the appropriate Application by number.

Press the **E** key to load the Application.

Refer to Chapter 12: "Applications" for further information.

Selecting the Menu Detail

For ease of operation the drive can display full or reduced menus. Refer to Chapter 6 to see how the setting changes the displayed menu. Additional parameters are indicated with **f** in the table.

Navigate to the **St 99** parameter (SET::SETP::ST99) and press the **M** key. This toggles full or partial menu detail. The default setting of 0 provides partial menu detail. Set the parameter to 1 for full menu detail.

PROGRAMMING YOUR APPLICATION

You can program the drive to your specific application. This programming simply involves changing parameter values. Access the parameters using the keypad.

For instance, parameter ^P1 selects various Applications which can be used as starting points for application-specific programming. Each Application internally re-wires the drive for a different use when it is loaded. The default for the parameter is "1". Changing this parameter's setting to "2" will load Application 2. Refer to Chapter 12: "Applications" for further information.

If necessary, there are three parameters for tuning your drive. Refer to PID, page 6-6.

Saving Your Modifications

When parameter values are modified or an Application is loaded, the new settings are saved automatically. The drive will retain the new settings during power-down.

Configurable Parameters

Display	Parameter	Description	Range	Default
SET::PAR Menu				
P 1	APPLICATION	Selects the Application to be used (Application 0 does not control a motor) Application 1: Basic Speed Control Application 2: Manual/Auto Application 3: Presets Application 4: Raise/Lower Application 5: PI Control Note: Parameter values are changed to factory settings by loading a new Application, except Motor-Specific parameters ^P 2, ^P 6, ^P 7 and ^P 8.	0= APPLICATION 0 1= APPLICATION 1 2= APPLICATION 2 3= APPLICATION 3 4= APPLICATION 4 5= APPLICATION 5	1
P 2	MAX SPEED	The frequency at which the 650 will run when maximum setpoint is applied. The default is Product Code dependent	7.5 to 240.0Hz	50.0Hz or 60.0Hz
P 3	MIN SPEED	The minimum frequency at which the 650 will run, as a percentage of the MAX SPEED parameter	-100.0 to 100.0%	0.0%
P 4	ACCEL TIME	The time taken for the 650 output frequency to ramp up from zero to MAX SPEED	0.0 to 3000.0s	10.0s
P 5	DECEL TIME	The time taken for the 650 output frequency to ramp down from MAX SPEED to zero	0.0 to 3000.0s	10.0s
P 6	MOTOR CURRENT	This parameter contains the motor nameplate full-load line current	Product code dependent	product code dependent
P 7	BASE FREQUENCY	The output frequency at which maximum voltage is reached. The default is Product Code dependent	25.0 to 240.0Hz	50.0Hz or 60.0Hz
P 8	JOG SETPOINT	Speed the 650 will run at if the Jog input is high, as a percentage of the MAX SPEED parameter	-100.0 to 100.0%	10.0%
P 9	RUN STOP MODE	RAMP : The motor speed is reduced to zero at a rate set by DECEL TIME (^P 5). A 2 second DC pulse is applied at end of ramp COAST : The motor is allowed to freewheel to a standstill INJECTION : On a stop command, the motor volts are rapidly reduced at constant frequency to deflux the motor. A low frequency braking current is then applied until the motor speed is almost zero. This is followed by a timed DC pulse to hold the motor shaft.	0=RAMP 1=COAST 2=INJECTION	0

Display	Parameter	Description	Range	Default
P 11	V/F SHAPE	<p>LINEAR : This gives a constant flux characteristic up to the BASE FREQUENCY</p> <p>FAN : This gives a quadratic flux characteristic up to the BASE FREQUENCY. This matches the load requirement for fan and most pump applications Refer to P12</p> <div style="text-align: center;"> <p>OUTPUT VOLTS</p> <p>100% ———</p> <p>LINEAR</p> <p>QUADRATIC LAW</p> <p>f_B = BASE FREQUENCY f_B</p> <p>FREQUENCY</p> <p>CONSTANT POWER RANGE</p> </div>	0=LINEAR 1=FAN	0
P 12	HEAVY/NORMAL DUTY	<p>% OF RATED MOTOR CURRENT (HEAVY DUTY)</p> <div style="text-align: center;"> <p>150%</p> <p>127.5%</p> <p>105%</p> <p>100%</p> <p>30 60</p> <p>TIME (s)</p> <p>100% overload for 30s</p> </div> <p>HEAVY DUTY: Inverse time allows 150% overload for 30s, then ramps back the current limit to 105% over a 10s period. At a lower load, the overload area remains the same, e.g. at 127.5% load for 60s - after 60s has expired, the output of the inverse time function is ramped back over a 10s period from 150% as before.</p> <p>NORMAL DUTY: the current limit is set to 110% motor current, inverse time delay is set to 10s</p> <p>When P11 is changed from FAN to LINEAR, P12 is set to 0 (HEAVY)</p> <p>When P11 is changed from LINEAR to FAN, P12 is set to 1 (NORMAL)</p> <p>P12 can be changed independently</p>	0=HEAVY 1=NORMAL:	0
P 13	FIXED BOOST	<p>Used to correctly flux the motor at low speeds. This allows the drive to produce greater starting torque for high friction loads. It increases the motor volts above the selected V/F characteristic at the lower end of the speed range</p> <div style="text-align: center;"> <p>OUTPUT VOLTS</p> <p>100%</p> <p>25%</p> <p>0%</p> <p>INCREASED TORQUE FLUXING</p> <p>NORMAL FLUXING</p> <p>INCREASING BOOST</p> <p>f_B = BASE FREQUENCY f_B</p> <p>FREQUENCY</p> <p>CONSTANT POWER RANGE</p> </div>	0.00 to 25.00%	5.00%
P 99	PASSWORD	<p>A password may be set to prohibit unauthorised adjustment of parameters. When P99 is set to non-zero you will be required to match this value before parameters can be adjusted</p>	0000 – FFFF	0000
<i>Parameters P301 to P308 are visible in the PAR menu when Application 3 is selected in parameter P1</i>				
P 301	PRESET 0	A user-adjustable speed preset set by potentiometer	-100.00 to 100.00	-
P 302	PRESET 1	A user-adjustable speed preset	-100.00 to 100.00	20.00
P 303	PRESET 2	A user-adjustable speed preset	-100.00 to 100.00	50.00
P 304	PRESET 3	A user-adjustable speed preset	-100.00 to 100.00	100.00

6-3 Programming Your Application

Display	Parameter	Description	Range	Default
P 305	PRESET 4	A user-adjustable speed preset	-100.00 to 100.00	-10.00
P 306	PRESET 5	A user-adjustable speed preset	-100.00 to 100.00	-20.00
P 307	PRESET 6	A user-adjustable speed preset	-100.00 to 100.00	-50.00
P 308	PRESET 7	A user-adjustable speed preset	-100.00 to 100.00	-100.00
<i>Parameters ^P401 to ^P404 are visible in the PAR menu when Application 4 is selected in parameter ^P1</i>				
P 401	R/L RAMP TIME	The time taken to ramp the Raise/Lower output from 0.00% to 100.00% of its value	0.0 to 600.0s	10.0s
P 402	R/L MAX VALUE	The maximum value for the ramp output	-100.0 to 100.0%	100.0%
P 403	R/L MIN VALUE	The minimum value for the ramp output	-100.0 to 100.0%	0.0%
P 404	R/L RESET VALUE	The value the output is set to when Reset is TRUE, when DIN4 (terminal 10) is 24V in Application 4	-100.00 to 100.00%	0.00%
<i>Parameters ^P501 and ^P502 are visible in the PAR menu when Application 5 is selected in parameter ^P1</i>				
P 501	PI P GAIN	The PI proportional gain	0.00 to 100.00	1.00
P 502	PI I GAIN	The PI integral gain	0.00 to 100.00	0.00
P 503	PID D GAIN	The PID derivative gain	0.00 to 100.00	0.00
P 504	PID D FILTER TC	In order to help attenuate high frequency noise on the derivative term, a first order lag has been provided. This parameter determines the filter time constant.	0.05 to 10.00s	0.05s
P 505	PID FEEDBACK GAIN	A multiplier applied to the feedback signal of the PID	-10.00 to 10.00	1.00
P 506	PID LIMIT	Determines the maximum positive and negative excursion (Limit) of the PID output	0.00 to 300.00%	300.00%

SET:IN Menu

5 IP01	DIN 1 INVERT	Inverts the value of the signal, TRUE or FALSE.	0= NOT INVERTED 1= INVERTED	0
5 IP02	DIN 2 INVERT	As ^S IP01	As ^S IP01	0
5 IP03	DIN 3 INVERT	As ^S IP01	As ^S IP01	0
5 IP04	DIN 4 INVERT	As ^S IP01	As ^S IP01	0
5 IP11	AIN 1 SCALE		-150.0 to 150.0%	100.0%
5 IP12	AIN 1 OFFSET		-100.0 to 100.0%	0.00%
5 IP13	AIN 1 TYPE		0 to 100% of selected TYPE	0= 0-10V 1= 0-5V
5 IP21	AIN 2 SCALE		-150.0 to 150.0%	0.00%
5 IP22	AIN 2 OFFSET		-100.0 to 100.0%	100.0%
5 IP23	AIN 2 TYPE		0 to 100% of selected TYPE	0= 0-10V 1= 0-5V 2= 0-20mA 3= 4-20mA
5 IPd1	DIN 1 VALUE	The TRUE or FALSE input (after any inversion)	0=FALSE 1=TRUE	0
5 IPd2	DIN 2 VALUE	The TRUE or FALSE input (after any inversion)	0=FALSE 1=TRUE	0
5 IPd3	DIN 3 VALUE	The TRUE or FALSE input (after any inversion)	0=FALSE 1=TRUE	0

Display	Parameter	Description	Range	Default
5 IPd4	DIN 4 VALUE F	The TRUE or FALSE input (after any inversion)	0=FALSE 1=TRUE	0
5 IPA1	AIN 1 VALUE F	The input reading with scaling and offset applied	—.xx%	0.00%
5 IPA2	AIN 2 VALUE F	The input reading with scaling and offset applied	—.xx%	0.00%

SET::OUT Menu				
5 OP01	AOUT 1 SOURCE	ANALOG OUTPUT 0 NONE 1 DEMAND % 2 CURRENT % 3 PI ERROR % 4 RAISE/LOWER % OUTPUT	SCALE 5 OP02 OFFSET 5 OP03 ABSOLUTE 5 OP04	0= NONE 1= DEMAND 2= CURRENT 3= PI ERROR 4= RAISE/LOWER OUTPUT
5 OP02	AOUT 1 SCALE			-300.0 to 300.0
5 OP03	AOUT 1 OFFSET			-300.0 to 300.0%
5 OP04	AOUT 1 ABSOLUTE			0= NOT ABSOLUTE 1= ABSOLUTE
5 OP21	DOUT 2 SOURCE	DIN4 / DOUT2 0 NONE 1 HEALTH 2 TRIPPED 3 RUNNING 4 AT ZERO 5 AT SPEED 6 AT LOAD	INVERT (output) 5 IP04	0= NONE 1= HEALTH 2= TRIPPED 3= RUNNING 4= AT ZERO 5= AT SPEED 6= AT LOAD
5 OP22	DOUT 2 INVERT	(OUTPUT) As 5 IP01. Set to 0 for applications 1 & 5.		As 5 IP01
5 OP31	RELAY SOURCE	NONE : Relay is open Relay is closed when: HEALTH : the Run signal is not present, or no trip is active TRIPPED : a trip is present RUNNING : the motor is running AT ZERO : the output frequency is below 1% of MAX SPEED (P2) AT SPEED : the output frequency is within 1% MAX SPEED (P2) AT LOAD : the magnitude of the output torque is greater than or equal to the torque level set in ST42	INVERT (output) 5 OP32	As 5 OP21
5 OP32	RELAY INVERT	As 5 IP01		As 5 IP01

6-5 Programming Your Application

Display	Parameter	Description	Range	Default
SET::TRIP Menu				
5LOOP	DISABLE LOOP	Disables LOST I LOOP trip (4-20mA)	0= TRIP ENABLED 1= TRIP DISABLED	1
5STLL	DISABLE STALL	Disables STALL trip	As 5LOOP	0
5Ote	DISABLE MOTOR OVERTEMP	Disables the motor thermistor trip	As 5LOOP	0
5dCRP	DC LINK RIPPLE	Disables the DC link ripple trip	As 5LOOP	0
SET::SETP Menu				
5SE01	JOG ACCEL TIME	As ^P 4, for Jog	0.0 to 3000.0s	1.0
5SE02	JOG DECEL TIME	As ^P 5, for Jog	0.0 to 3000.0s	1.0
5SE03	RAMP TYPE	Selects the ramp type	0=LINEAR 1=S	0
5SE04	S RAMP JERK	Rate of change of acceleration of the curve in units per second ³	0.01 to 100.00 s ⁻³	10.00
5SE05	S RAMP CONTINUOUS	When TRUE and the S ramp is selected, forces a smooth transition if the speed setpoint is changed when ramping. The curve is controlled by the S RAMP JERK parameter. When FALSE, there is an immediate transition from the old curve to the new curve	0=FALSE 1=TRUE	1
5SE11	SKIP FREQUENCY 1	This parameter contains the centre frequency of skip band 1 in Hz	0.0 to 240.0 Hz	0.0
5SE12	SKIP FREQUENCY BAND 1	The width of skip band 1 in Hz	0.0 to 60.0 Hz	0.0
5SE13	SKIP FREQUENCY 2	This parameter contains the centre frequency of skip band 2 in Hz	0.0 to 240.0 Hz	0.0
5SE14	SKIP FREQUENCY BAND 2	The width of skip band 2 in Hz	0.0 to 60.0 Hz	0.0
5SE21	AUTO RESTART ATTEMPTS	Determines the number of restarts that will be permitted before requiring an external fault reset	0 to 10	0
5SE22	AUTO RESTART DELAY	Determines the delay between restart attempts for a trip included in AUTO RESTART TRIGGERS and AUTO RESTART TRIGGERS+. The delay is measured from all error conditions clearing	0.0 to 600.0 s	10.0
5SE23	AUTO RESTART TRIGGERS	Allows Auto Restart to be enabled for a selection of trip conditions. Refer to Chapter 7: "Trips and Fault Finding" - Hexadecimal Representation of Trips	0x0000 to 0xFFFF	0x0000
5SE24	AUTO RESTART TRIGGERS+	Allows Auto Restart to be enabled for a selection of trip conditions. Refer to Chapter 7: "Trips and Fault Finding" - Hexadecimal Representation of Trips	0x0000 to 0xFFFF	0x0000
5SE98	APPLICATION LOCK	Setting this parameter to TRUE prevents editing of parameter ^P 1. Set this parameter to FALSE to edit parameter ^P 1.	0=FALSE 1=TRUE	0
5SE99	MENU DETAIL	Selects FULL or PARTIAL menu detail. The additional parameters in the FULL menus are indicated in this table by F	0=PARTIAL 1=FULL	0

Configuring Terminal 10 (Digital Input/Output)

Terminal 10 can be operated as digital input DIN4 or digital output DOUT2.

Configure for use as DIN4 (default)

To use terminal 10 as an input, the output circuitry must be disabled by setting ^SOP21 and ^SOP22 to zero. You can invert this logic using parameter ^SIP04.

Parameter	Setting
^SOP21 DOUT2 SOURCE	0
^SOP22 DOUT2 INVERT	0
^SIP04 DIN4 INVERT	Default is 0, setting to 1 inverts the input logic

Configure for use as DOUT2

To use terminal 10 as an output, select ^SOP21 to be 1, 2, 3, 4, 5 or 6. For example, you could set parameter ^SOP31 to 3 to have the output go high (24V) whenever the motor is running. You could use this to operate an external relay or lamp, for instance. You can invert this logic using parameter ^SOP22.

Parameter	Setting
^SOP21 DOUT2 SOURCE	<i>The output is high when:</i>
	1 = HEALTH The Run signal is not present, or no trip is active
	2 = TRIPPED A trip is present
	3 = RUNNING The motor is running
	4 = AT ZERO The output frequency is below 1% of MAX SPEED (^P 2)
	5 = AT SPEED The output frequency is within 1% MAX SPEED (^P 2)
	6 = AT LOAD The magnitude of the output torque is greater than or equal to the torque level set in ST 42
Always set ^S IP04 to 0 if using Applications 1 and 5 – refer to Chapter 12.	
^SOP22 DOUT2 INVERT	Default is 0, setting to 1 inverts the output logic

PID

PI is used to control the response of any closed loop system. It is used specifically in system applications involving the control of drives to provide zero steady state error between Setpoint and Feedback, together with good transient performance.

Proportional Gain (^P501)

This is used to adjust the basic response of the closed loop control system. The PI error is multiplied by the Proportional Gain to produce an output.

Integral (^P502)

The Integral term is used to reduce steady state error between the setpoint and feedback values of the PI. If the integral is set to zero, then there will always be a steady state error.

6-7 Programming Your Application

Derivative (P503)

This is used to correct for certain types of control loop instability, and therefore improve response. It is sometimes used when heavy or large inertia rolls are being controlled. The derivative term has an associated filter to suppress high frequency signals.

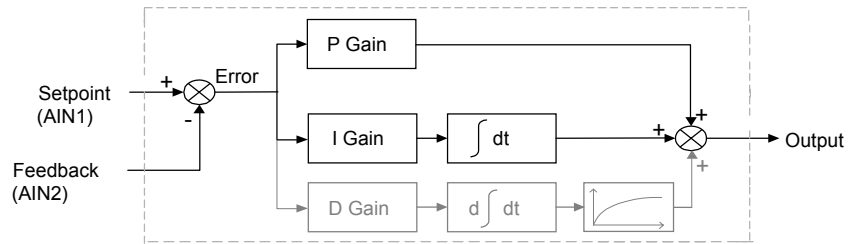

- Functions as P, PI, PID controller
- Single symmetric limit on output

A Method for Setting-up the PI Gains

The gains should be set-up so that a critically damped response is achieved for a step change in setpoint. An underdamped or oscillatory system can be thought of as having too much gain, and an overdamped system has too little.

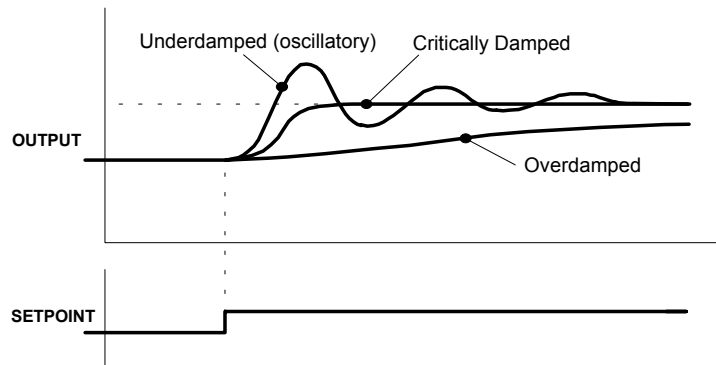

To set up the P gain, set the I gain to zero. Apply a step change in setpoint that is typical for the System, and observe the response. Increase the gain and repeat the test until the system becomes oscillatory. At this point, reduce the P gain until the oscillations disappear. This is the maximum value of P gain achievable.

If a steady state error is present, i.e. the feedback never reaches the setpoint value, the I gain needs to be increased. As before, increase the I gain and apply the step change. Monitor the output. If the output becomes oscillatory, reduce the P gain slightly. This should reduce the steady state error. Increasing the I gain further may reduce the time to achieve zero steady state error.

These values of P and I can now be adjusted to provide the exact response required for this step change.

Auto Restart

This provides the facility to automatically reset a choice of trip events and restart the drive with a programmed number of attempts. If the drive is not successfully started, a manual or remote trip reset is required.

The number of attempted restarts are recorded. This count is cleared after a trip-free period of operation (5 minutes or 4 x AUTO RESTART DELAY, whichever is the longer); or after a successful manual or remote trip reset; or by removing the Run signal (Terminal 7, DIN1).

Skip Frequencies

Two programmable skip frequencies are available to prevent the drive from operating at frequencies that cause mechanical resonance in the load.

- Enter the value of the frequency that causes the resonance into the SKIP FREQUENCY parameter.
- Enter a width for the skip band into the SKIP FREQUENCY BAND parameter.

The drive will then avoid sustained operation within the forbidden band as shown in the diagram. The skip frequencies are symmetrical and thus work in forward and reverse.

Setting SKIP FREQUENCY or SKIP FREQUENCY BAND to 0 disables the corresponding band.

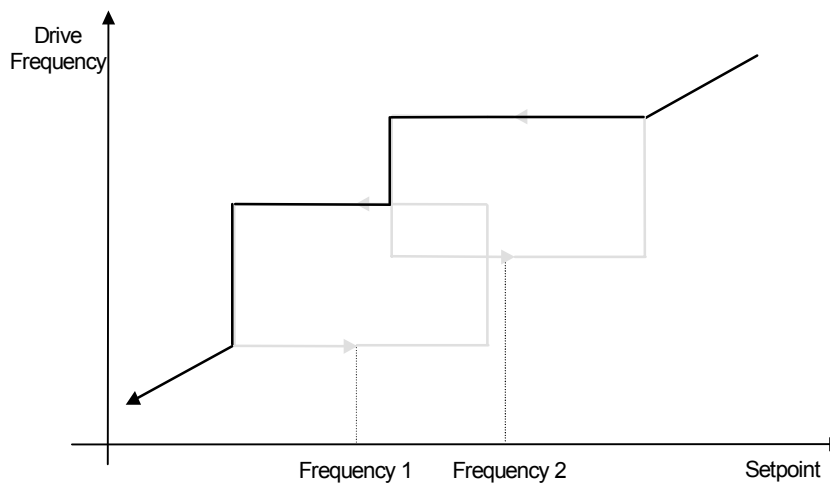
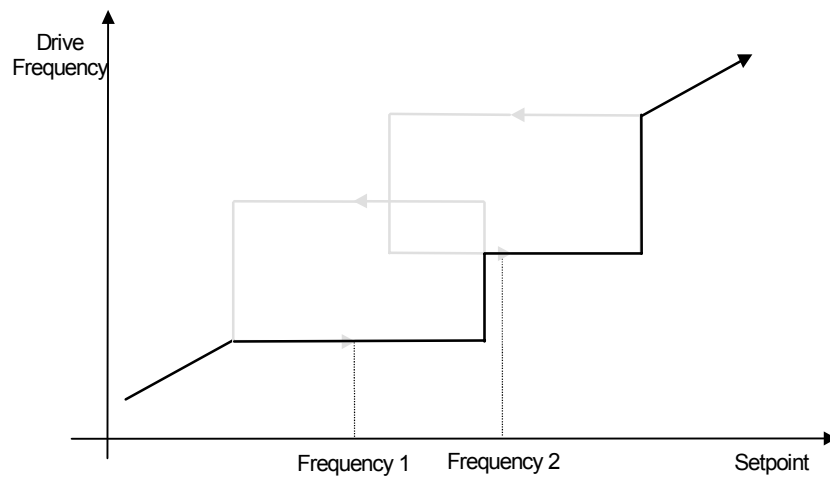
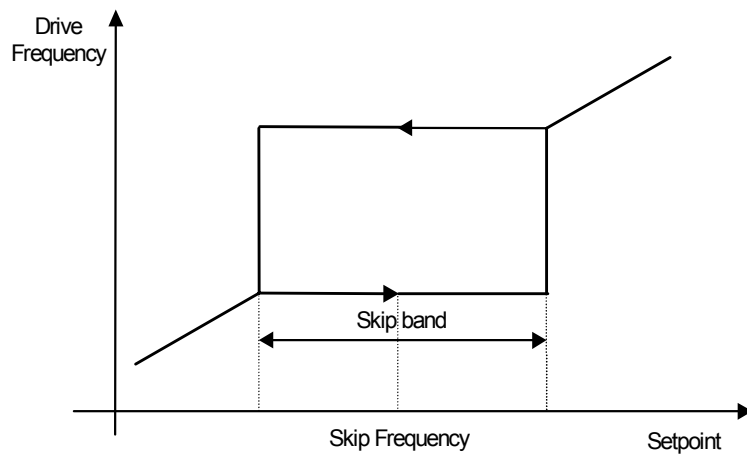

Product-Related Default Values

Frequency Dependent Parameters

The values in the table below are set by changing the "default frequency" parameter. To do this, power-down the drive. Power-up the drive holding down the STOP and DOWN keys. Release the keys to display the ° 0.01 parameter.

Caution

You are now in a menu containing some sensitive and important parameters.

Press the UP key to display the ° 0.02 parameter. Press the M key. The values for this parameter are: 0 = 50Hz default, 1 = 60Hz default. Select the setting using the UP/DOWN keys and then press the E key. Power-down the drive and power-up again holding down the UP and DOWN keys. This resets **ALL** parameters to their correct default values.

		50Hz default	60Hz default
P 2	MAX SPEED	50	60
P 7	BASE FREQUENCY	50	60

Power Dependent Parameters

These parameters are set to a value depending on the overall "power-build" of the drive indicated by the Product Code, and described here by parameters CL15 and CL12, blocks 2 & 3 of the Product Code.

We recommend that you do not change the Product Code.

		650 Model	Default
P 6	MOTOR CURRENT	Frame 1 : 0.25kW 230V	1.5A
		Frame 1 : 0.37kW 230V	2.2A
		Frame 1 : 0.55kW 230V	3.0A
		Frame 1 : 0.75kW 230V	4.0A
		Frame 2 : 1.1kW 230V	5.5A
		Frame 2 : 1.5kW 230V	7.0A
		Frame 2 : 0.37kW 400V	1.5A
		Frame 2 : 0.55kW 400V	2.0A
		Frame 2 : 0.75kW 400V	2.5A
		Frame 2 : 1.1kW 400V	3.5A
		Frame 2 : 1.5kW 400V	4.5A
		Frame 2 : 2.2kW 400V	5.5A
		Frame 3 : 2.2kW 230V	13.0A
		Frame 3 : 3.0kW 230V	18.0A
		Frame 3 : 4.0kW 230V	23.0A
		Frame 3 : 3.0kW 400V	6.8A
Frame 3 : 4.0kW 400V	9.0A		
Frame 3 : 5.5kW 400V	12.0A		
Frame 3 : 7.5kW 400V	16.0A		

TRIPS AND FAULT FINDING

Trips

Trip Warning Message

The trip display message is flashed repeatedly on the screen to warn of an imminent trip. Some trip conditions need time to take effect. The warning can allow you time to rectify the situation.

The message will clear when you use the Keypad, but after a short time will reappear until the problem is resolved, or the drive trips.

What Happens when a Trip Occurs

When a trip occurs, the drive's power stage is immediately disabled causing the motor and load to coast to a stop. The trip is latched until action is taken to reset it. This ensures that trips due to transient conditions are captured and the drive is disabled, even when the original cause of the trip is no longer present.

Keypad Indications

If a trip condition is detected the activated alarm is displayed on the MMI display.

Resetting a Trip Condition

All trips must be reset before the drive can be re-enabled. A trip can only be reset once the trip condition is no longer active, i.e. a trip due to a heatsink over-temperature will not reset until the temperature is below the trip level.

You can reset the trip as follows:



1. Press the  (STOP) key to reset the trip and clear the alarm from the display.
2. Remove and then re-apply the RUN command and the drive will run normally.

Success is indicated by either **rdy** or the Local Setpoint being displayed.

Using the Keypad to Manage Trips



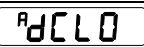

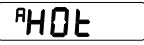
Trip Messages

If the drive trips, then the display immediately shows a message indicating the reason for the trip. The possible trip messages are given in the table below.

Display	Trip Message and Meaning	Possible Reason for Trip
	DC LINK HIGH The drive internal dc link voltage is too high	The supply voltage is too high Trying to decelerate a large inertia load too quickly; DECEL TIME time too short The brake resistor is open circuit (400V unit only)
	DC LINK LOW	DC LINK low trip. Supply is too low/power down
	OVERCURRENT The motor current being drawn from the drive is too high	Trying to accelerate a large inertia load too quickly; ACCEL TIME time too short Trying to decelerate a large inertia load too quickly; DECEL TIME time too short Application of shock load to motor Short circuit between motor phases Short circuit between motor phase and earth Motor output cables too long or too many parallel motors connected to the drive FIXED BOOST level set too high
	HEATSINK OVERTEMPERATURE Drive heatsink temperature > 100°C	The ambient air temperature is too high Poor ventilation or spacing between drives

7-2 Trips and Fault Finding

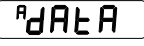
Display	Trip Message and Meaning	Possible Reason for Trip
A E t	EXTERNAL TRIP	The external trip input is high. Check configuration to identify the source of the signal (non-standard configuration)
A LOOP	LOST I LOOP (Disable: S LOOP)	A current of less than 1mA is present when 4-20mA setpoint is selected – look for a wire break
A S t L L	STALL (Disable: S S t L L) The motor has stalled (not rotating) Drive in current limit >200 seconds	Motor loading too great FIXED BOOST level set too high
A t 3	TERMINAL 3 OVERLOAD	AIN2 overload – overcurrent applied in Current mode
A d I S P	DISPLAY (KEYPAD) Keypad has been disconnected from drive whilst drive is running in Local Control	Keypad accidentally disconnected from drive (indicated over comms, or by second keypad)
A S C I	SERIAL COMMS	COMMS TIMEOUT parameter set too short Master device failed Wiring broken Incorrect comms setup
A C n t C	CONTACTOR FEEDBACK	Check connection to the terminal wired to "contactor closed" parameter in Sequencing Logic (non-standard configuration)
A O t	MOTOR OVERTEMPERATURE The motor temperature is too high	Excessive load; motor voltage rating incorrect; FIXED BOOST level set too high; prolonged operation of the motor at low speed without forced cooling; break in motor thermistor connection
A I H I	CURRENT LIMIT Software overcurrent trip	If the current exceeds 180% of stack rated current for a period of 1 second, the drive will trip. This is caused by shock loads. Remove the shock load. Other causes are: ACCEL TIME and/or FIXED BOOST set too high; DECEL TIME set too low
A L S P d	LOW SPEED OVERCURRENT The motor is drawing too much current (>100%) at zero output frequency	Fixed BOOST level set too high
A t 4	TERMINAL 4 OVERLOAD	+10V REF overload warning - 10mA maximum
A S h t t	DESATURATION	Instantaneous overcurrent. Refer to OVERCURRENT in this table.
A d C r P	DC LINK RIPPLE A dc link ripple alert	Supply imbalance in a 3-phase system Poor supply regulation in a 1-phase system
A d b S C	DYNAMIC BRAKE SHORT Brake resistor overcurrent	Check brake resistor value is greater than minimum allowed
A t 5	TERMINAL 5 OVERLOAD	AOUT overload - 10mA maximum
t 9	TERMINAL 9 OVERLOAD	DIN3 overload – 20mA maximum
A t 10	TERMINAL 10 OVERLOAD	DOUT2 overload – 50mA maximum
A t r I P	UNKNOWN TRIP	Unknown trip
A t r 32	OTHER	"OTHER" trip is active (Trip ID 33)
A I C A L	ZERO I CURRENT CALIBRATION	Current sensor calibration fault. Switch unit off/on. If persistent, return unit to factory

Display	Trip Message and Meaning	Possible Reason for Trip
	Product Code Error	Switch unit off/on. If persistent, return unit to factory
	Calibration Data Error	Switch unit off/on. If persistent, return unit to factory
	Configuration Data Error	Press the  key to accept the default configuration. If persistent, return unit to factory

Hexadecimal Representation of Trips

The tables below show the possible parameter values for the AUTO RESTART TRIGGERS and AUTO RESTART TRIGGERS+ parameters, ^SSt23 and ^SSt24 respectively. They use a four digit hexadecimal number to identify individual trips. Each trip has a unique corresponding number as shown below.

ID	Display	Trip Name	Mask	Disable	Description
0		NO TRIP	0x0000	N/A	There is no trip present
1	DCHI	OVERVOLTAGE	0x0001		Over-volts
2	DCLO	UNDERVOLTAGE	0x0002		Under-volts
3	OC	OVERCURRENT	0x0004		Over current
4	HOT	HEATSINK	0x0008	✓	Heatsink over temperature
5	ET	EXTERNAL TRIP	0x0010	✓	External trip
7	LOOP	LOOP	0x0040	✓	Analogue input 2 current input signal lost
8	STLL	MOTOR STALLED	0x0080	✓	Stall
9	T 3	AIN2 FAULT (T3)	0x0100	✓	Terminal 3. Analogue input 2 overload in current mode, (> ~22mA)
12	DISP	DISPLAY (KEYPAD)	0x0800	✓	Operator station removed when in local mode.
13	SCI	LOST COMMS	0x1000	✓	Comms watchdog timeout when in remote comms mode
14	CNTC	CONTACTOR FBK	0x2000	✓	Contactors feedback, (external contactor not closed within allowed time)
ID	Display	Trip Name	Mask +	Disable	Description
17	OT	MOTOR OVERTEMP	0x0001	✓	Motor over-temperature
18	I HI	CURRENT LIMIT	0x0002	✓	High current, >180% stack current for 1 second, (>190% for size F).
21	LSPD	LOW SPEED OVER I	0x0010	✓	Low speed over-current.
22	T 4	10V REF (T4)	0x0020	✓	Terminal 4. 10v output overload, WARNING ONLY.
24	SHRT	SHORT CIRCUIT	0x0080		Short circuit on motor output
25	DCRP	VDC RIPPLE	0x0100	✓	DC ripple
26	DBSC	BRAKE SHORT CIRCUIT	0x0200		Short circuit across dynamic brake resistor
28	T 5	ANOUT (T5)	0x0800	✓	Terminal 5. Analogue output overload, WARNING ONLY
29	T 9	DIGIO1 (T9)	0x1000	✓	Terminal 9. Digital output 1 overload.
30	T 10	DIGIO2 (T10)	0x2000	✓	Terminal 10, Digital output 2 overload
31	TRIP	UNKNOWN	0x4000		Unknown trip
33	ICAL	CURRENT CALIB	0x8000		Zero current calibration

7-4 Trips and Fault Finding

When more than one trip is to be represented at the same time then the trip codes are simply added together to form the value displayed. Within each digit, values between 10 and 15 are displayed as letters A to F

For example referring to the table above, if the AUTO RESTART TRIGGERS parameter is **00C3**, then this represents:

an "8" and a "4" in digit 2
(8+4 = 12, displayed as C)

a "1" and a "2" in digit 1
(1+2 = 3)

This in turn represents the active trips MOTOR STALLED, LOOP, OVERVOLTAGE and UNDERVOLTAGE, (an unlikely situation).

In the same way, the AUTO RESTART TRIGGERS+ parameter displaying **00C3** would represent DESAT (OVER I), *(TRIP 23 (Reserved))*, CURRENT LIMIT and MOTOR OVERTEMP (another unlikely situation).

Fault Finding

Problem	Possible Cause	Remedy
Drive will not power-up	Fuse blown	Check supply details, fit correct fuse. Check Product Code against Model No.
	Faulty cabling	Check all connections are correct/secure. Check cable continuity
Drive fuse keeps blowing	Faulty cabling or connections wrong	Check for problem and rectify before replacing with correct fuse
	Faulty drive	Contact Eurotherm Drives
Cannot obtain power-on state	Incorrect or no supply available	Check supply details
Motor will not run at switch-on	Motor jammed	Stop the drive and clear the jam
Motor runs and stops	Motor becomes jammed	Stop the drive and clear the jam
	Open circuit speed reference potentiometer	Check terminal

ROUTINE MAINTENANCE AND REPAIR

Routine Maintenance

Periodically inspect the drive for build-up of dust or obstructions that may affect ventilation of the unit. Remove this using dry air.

Repair

There are no user-serviceable components.

IMPORTANT: MAKE NO ATTEMPT TO REPAIR THE UNIT - RETURN IT TO EUROTHERM DRIVES.

Saving Your Application Data

In the event of a repair, application data will be saved whenever possible. However, we advise you to copy your application settings before returning the unit.

Returning the Unit to Eurotherm Drives

Please have the following information available:

- The model and serial number - see the unit's rating label
- Details of the fault

Contact your nearest Eurotherm Drives Service Centre to arrange return of the item.

You will be given a *Returned Material Authorisation*. Use this as a reference on all paperwork you return with the faulty item. Pack and despatch the item in the original packing materials; or at least an anti-static enclosure. Do not allow packaging chips to enter the unit.

Disposal

This product contains materials which are consignable waste under the Special Waste Regulations 1996 which complies with the EC Hazardous Waste Directive - Directive 91/689/EEC.

We recommend you dispose of the appropriate materials in accordance with the valid environmental control laws. The following table shows which materials can be recycled and which have to be disposed of in a special way.

Material	Recycle	Disposal
metal	yes	no
plastics material	yes	no
printed circuit board	no	yes

The printed circuit board should be disposed of in one of two ways:

1. High temperature incineration (minimum temperature 1200°C) by an incinerator authorised under parts A or B of the Environmental Protection Act
2. Disposal in an engineered land fill site that is licensed to take aluminium electrolytic capacitors. Do not dispose of in a land fill site set aside for domestic waste.

Packaging

During transport our products are protected by suitable packaging. This is entirely environmentally compatible and should be taken for central disposal as secondary raw material.

Technical Specifications

Understanding the Product Code

Model Number (Europe)

The unit is fully identified using a nine block alphanumeric code which records how the drive was calibrated, and its various settings when despatched from the factory.

The Product Code appears as the “Model No.” on the product rating label. Each block of the Product Code is identified as below:

650/003/230/F/00/DISP/UK/0/0
Block 1 2 3 4 5 6 7 8 9
example product code

Frame 1, 2, 3 – Model Number (Europe)		
Block No.	Variable	Description
1	650	Generic Volts/Hertz product
2	XXX	Three numbers specifying the power output: 002 = 0.25kW 011 = 1.1kW 040 = 4.0kW 003 = 0.37kW 015 = 1.5kW 055 = 5.5kW 005 = 0.55kW 022 = 2.2kW 075 = 7.5kW 007 = 0.75kW 030 = 3.0kW
3	XXX	Three numbers specifying the nominal input voltage rating: 230 = 220 to 240V (±10%) 50/60Hz 400 = 380 to 460V (±10%) 50/60Hz
4	X	One character specifying the use of the Internal RFI Filter: 0 = Not fitted F = Internal Supply Filter fitted: Class A - 400V product Class B - 230V product
5	XX	Two digits specifying the livery: 00 = Standard Eurotherm Drives Livery 05 = Distributor Livery (01-04, 06-99 – Defined customer liveries)
6	XXXXX	Characters specifying the use of the Keypad: 0 = Not fitted DISP = TTL Keypad fitted DISPR = RS232 Keypad fitted (remote mountable). Block 8 must = RS0 with this selection.
7	XX	Two Characters specifying the user labelling language: FR French (50Hz) UK English (50Hz) GR German (50Hz) US English (60Hz) IT Italian (50Hz) SP Spanish (50Hz) (figures in brackets are the drive’s default base frequency setting, ^{P7})

Frame 1, 2, 3 – Model Number (Europe)		
Block No.	Variable	Description
8	XXX	Characters specifying the RS232 (P3) port fitting: 0 = No RS232 port (drive uses TTL Keypad) RS0 = RS232 port (drive uses RS232 Keypad)
9	XXX	Numbers specifying any special option: 0 = Standard Product 001-999 = special option fitted

Catalog Number (North America)

The unit is identified using a 4 block alphanumeric code which records how the drive was calibrated, and its various settings when dispatched from the factory.

The Product Code appears as the “Cat No.”. Each block of the Product Code is identified as below:

650/00F3/230/F
Block 1 2 3 4
example product code

Products with TTL Keypad		
Frame 1, 2, 3 – Catalog Number (North America)		
Block No.	Variable	Description
1	650	Generic product
2	XXXX	Four characters specifying the power output in Hp: 00F3 = 0.3Hp 01F5 = 1.5Hp 0005 = 5Hp 00F5 = 0.5Hp 0002 = 2Hp 0007 = 7Hp 00F7 = 0.75Hp 0003 = 3Hp 0010 = 10Hp 0001 = 1Hp
3	XXX	Three numbers specifying the nominal input voltage rating: 230 230 (±10%) 50/60Hz 460 380 to 460V (±10%) 50/60Hz
4	X	One character specifying the use of the Internal RFI Filter: 0 = Not fitted F = Internal Supply Filter fitted: Class A - 400V product Class B - 230V product

9-3 Technical Specifications

Environmental Details	
Operating Temperature	0°C to 40°C
Storage Temperature	-25°C to +55°C
Shipping Temperature	-25°C to +70°C
Product Enclosure Rating	IP20 (UL Open Type) suitable for cubicle mount only
Cubicle Rating	Cubicle to provide 15dB attenuation to radiated emissions between 30-100MHz. It must also require a security tool for opening
Altitude	If > 1000 metres (3300 feet) above sea level, derate Motor Power Rating by 1% per 100 metres (330 feet)
Humidity	Maximum 85% relative humidity at 40°C non-condensing
Atmosphere	Non flammable, non corrosive and dust free
Climatic Conditions	Class 3k3, as defined by EN50178 (1998)
Vibration	Test Fc of EN60068-2-6 19Hz <= f <= 57Hz sinusoidal 0.075mm amplitude 57Hz <= f <= 150Hz sinusoidal 1g 10 sweep cycles per axis on each of three mutually perpendicular axis
Safety	
Pollution Degree	Pollution Degree II (non-conductive pollution, except for temporary condensation)
Overvoltage Category	Overvoltage Category III (numeral defining an impulse withstand level)

Power Details	
1-Phase Supply	220-240V ac ±10%, 50/60Hz ±10%, ground referenced (TN) or non-ground referenced (IT)
3-Phase Supply	380-460V ac ±10%, 50/60Hz ±10%, ground referenced (TN) or non-ground referenced (IT)
Supply Power Factor (lag)	0.9 (@ 50/60Hz)
Output Frequency	0 – 240Hz
Overload	150% for 30 seconds
Supply Short Circuit Rating	220-240V product -5000A, 380-460V product -10000A

User Relay	
Terminals RL1A, RL1B.	
Maximum Voltage	250Vac
Maximum Current	4A resistive load
Sample Interval	10ms

Electrical Ratings

Motor power, output current and input current must not be exceeded under steady state operating conditions.

Maximum Motor $dv/dt = 10,000V/\mu s$. This can be reduced by adding a motor choke in series with the motor. Contact Eurotherm Drives for recommended choke details.

Local wiring regulations always take precedence. Select cable rated for the drive.

The supply must be protected with a fuse (or Type B RCD) rated to the supply cable.

FRAME 1 : 1-Phase (IT/TN), 230V

Drive Power (kW/hp)	Input Current @ 5kA		Output Current @ 40 °C (A) ac	Maximum Power Loss (W)
	Surge Current peak/rms for 10ms (A)	(A)		
0.25/0.3	19/12	4.2	1.5	26
0.37/0.5	19/12	6.2	2.2	32
0.55/0.75	20/14	7.9	3.0	41
0.75/1.0	22/15	10.5	4.0	52

FRAME 2 : 1-Phase (IT/TN), 230V

Drive Power (kW/hp)	Input Current @ 5kA		Output Current @ 40 °C (A) ac	Maximum Power Loss (W)
	Surge Current peak/rms for 10ms (A)	(A)		
1.1/1.5	24/17	13.8	5.5	65
1.5/2.0	25/18	16.0	7.0	82

FRAME 2 : 3-Phase (IT/TN), 400V

Drive Power (kW/hp)	Input Current @ 10kA (A)	Output Current @ 40 °C (A) ac	Maximum Power Loss (W)
0.37/0.5	2.5	1.5	26
0.55/0.75	3.3	2.0	32
0.75/1.0	4.1	2.5	40
1.1/1.5	5.9	3.5	55
1.5/2.0	7.5	4.5	61
2.2/3.0	9.4	5.5	70

FRAME 3 : 3-Phase (IT/TN), 200V

Drive Power (kW/hp)	Input Current @ 10kA (A)	Output Current @ 40 °C (A) ac	Maximum Power Loss (W)
2.2/3.0	14.3	9.6	82
3.0/4	18.1	12.3	108
4.0/5	23.1	16.4	147

FRAME 3 : 3-Phase (IT/TN), 400V

Drive Power (kW/hp)	Input Current @ 10kA (A)	Output Current @ 40 °C (A) ac	Maximum Power Loss (W)
3.0/4	11.1	6.8	80
4.0/5	13.9	9.0	100
5.5/7.5	18.0	12.0	136
7.5/10	23.6	16.0	180

9-5 Technical Specifications

Analog Inputs/Outputs		
Terminals AIN1, AIN2, AOUT1.		
	Inputs	Output
Range	0-10V and 0-5V (no sign) set via parameter ^s IP13 (AIN1) 0-10V, 0-5V, 0-20mA or 4-20mA (no sign) set via parameter ^s IP23 (AIN2) Absolute maximum input current 25mA in current mode Absolute maximum input voltage 24V dc in voltage mode	0-10V (no sign) Maximum rated output current 10mA, with short circuit protection
Impedance	Voltage input 20k Ω Current Input <6V @ 20mA	
Resolution	10 bits (1 in 1024)	10 bits (1 in 1024)
Dynamic Response	Sampled every 10ms	Bandwidth 15Hz

Digital Inputs										
Terminals DIN1, DIN2, DIN3, DIN4.										
Operating Range	0-5V dc = OFF, 15-24V dc = ON (absolute maximum input voltage \pm 30V dc) IEC1131	<table border="1"> <tr><td>24V</td><td>ON</td></tr> <tr><td>15V</td><td>undefined state</td></tr> <tr><td>5V</td><td></td></tr> <tr><td>0V</td><td>OFF</td></tr> </table>	24V	ON	15V	undefined state	5V		0V	OFF
24V	ON									
15V	undefined state									
5V										
0V	OFF									
Input Current	7.5mA @ 24V									
Sample Interval	10ms									

Digital Outputs	
Terminals DOUT2 (DOUT1 is reserved for future models).	
Nominal Open Circuit Output Voltage	23V (minimum 19V)
Nominal Output Impedance	33 Ω
Rated Output Current	50mA

Cabling Requirements for EMC Compliance				
	Power Supply Cable	Motor Cable	Brake Resistor Cable	Signal/Control Cable
Cable Type (for EMC Compliance)	Unscreened	Screened/armoured	Screened/armoured	Screened
Segregation	From all other wiring (clean)	From all other wiring (noisy)		From all other wiring (sensitive)
Length Limitations With Internal AC Supply EMC Filter	Unlimited	*25 metres	25 metres	25 metres
Length Limitations Without Internal AC Supply EMC Filter	Unlimited	25 metres	25 metres	25 metres
Screen to Earth Connection		Both ends	Both ends	Drive end only
Output Choke		300 metres maximum		
* Maximum motor cable length under any circumstances				

Internal Dynamic Braking Circuit (400V only)

The dynamic braking circuit is intended for with short term stopping or braking. The Frame 2 product is rated for continuous switch operation, however the Frame 3 product is rated for a maximum 30% duty. DC link brake voltage : 750V

Motor Power (kW/Hp)	Brake Switch Peak Current (A)	Brake Switch Continuous Current (A)	Peak Brake Dissipation (kW/Hp)	Minimum Brake Resistor Value (Ω)
Frame 2 : 3 Phase (IT/TN), 400V				
0.37/0.5	1.5	1.5	1.1/1.5	500
0.55/0.75	1.5	1.5	1.1/1.5	500
0.75/1.0	1.5	1.5	1.1/1.5	500
1.1/1.5	1.5	1.5	1.1/1.5	500
1.5/2.0	3.75	3.75	2.8/3.75	200
2.2/3.0	3.75	3.75	2.8/3.75	200
Frame 3 : 3 Phase (IT/TN), 400V				
3.0/4	7.5	2.3	5.6/7.5	100
4.0/5	7.5	2.3	5.6/7.5	100
5.5/7.5	13.5	4.0	10/13.4	56
7.5/10	13.5	4.0	10/13.4	56

External Brake Resistor (400V only)

All 650 units are supplied without braking resistors. The dynamic brake switch terminals allow easy connection to an external resistor. These resistors should be mounted on a heatsink (back panel) and covered to prevent injury from burning.

Recommended Brake Resistors

The following brake resistors are available from Eurotherm Drives:

Brake Resistor Value : Frame 2 : 200Ω, 100W - CZ467714; 500Ω, 60W - CZ467715
 Frame 3 : 56Ω, 500W - CZ467716; 100Ω, 200W - CZ467717

Alternative Brake Resistor Selection

Brake resistor assemblies must be rated to absorb both peak braking power during deceleration and the average power over the repeated cycles.

$$\text{Peak braking power } P_{pk} = \frac{0.0055 \times J \times (n_1^2 - n_2^2)}{t_b} \quad (\text{W})$$

J - total inertia (kgm²)

n₁ - initial speed (rpm)

n₂ - final speed (rpm)

t_b - braking time (s)

t_c - cycle time (s)

$$\text{Average braking power } P_{av} = \frac{P_{pk}}{t_c} \times t_b$$

Obtain information on the peak power rating and the average power rating of the resistors from the resistor manufacturer. If this information is not available, a large safety margin must be incorporated to ensure that the resistors are not overloaded. By connecting these resistors in series and in parallel the braking capacity can be selected for the application.

IMPORTANT: The minimum resistance of the combination and maximum dc link voltage must be as specified.

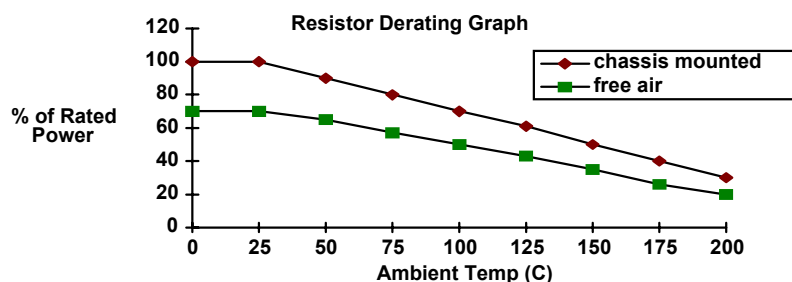

9-7 Technical Specifications

Supply Harmonic Analysis (filtered)

Assumptions: 5kA short circuit supply capability at 230V, equivalent to 146μH supply impedance
 10kA short circuit supply capability at 400V, equivalent to 127μH supply impedance

$$THD(V) \times 100 = \sqrt{\frac{\sum_{h=2}^{h=40} Q_{h^2}}{Q_{1n}}} \%$$

where Q_{1n} is the rated rms value of the fundamental voltage of the supply transformer.

The results conform to stage 1 and stage 2 of the Engineering Recommendation G.5/4 February 2001, Classification 'C': Limits for Harmonics in the UK Electricity Industry.

Drive Type	650															
Motor Power (kW)	0.25	0.37	0.55	0.75	1.1	1.5	0.37	0.55	0.75	1.1	1.5	2.2	3.0	4.0	5.5	7.5
Fundamental Voltage (V)	230	230	230	230	230	230	400	400	400	400	400	400	400	400	400	400
Typical Motor Efficiency %	85	85	85	85	85	85	85	85	85	85	85	85	85	85	85	85
Harmonic No.	RMS Current (A)															
1	7.4	7.5	7.8	8.2	9.0	10.3	0.6	1.0	1.3	1.9	2.6	3.8	5.2	6.9	9.5	12.9
3	1.4	0.2	1.9	2.2	2.9	3.9	0.0	0.0	0.0	0.0	0.0	0.0	0.0	0.0	0.0	0.0
5	2.9	0.4	4.4	4.6	4.8	5.2	0.6	0.9	1.2	1.8	2.4	3.5	4.7	6.2	8.3	11.1
7	1.1	0.5	1.9	2.0	2.3	2.5	0.6	0.9	1.2	1.7	2.3	3.3	4.3	5.5	7.3	9.5
9	0.2	0.2	0.2	0.3	0.4	0.4	0.0	0.0	0.0	0.0	0.0	0.0	0.0	0.0	0.0	0.0
11	0.1	0.1	0.2	0.2	0.2	0.3	0.5	0.8	1.0	1.5	1.9	2.6	3.3	3.9	4.8	5.7
13	0.0	0.1	0.1	0.1	0.1	0.1	0.0	0.7	0.9	1.3	1.6	2.2	2.7	3.0	3.5	3.9
15	0.1	0.0	0.1	0.1	0.1	0.1	0.4	0.0	0.0	0.0	0.0	0.0	0.0	0.0	0.0	0.0
17	0.0	0.1	0.0	0.0	0.0	0.1	0.4	0.6	0.7	1.0	1.1	1.4	1.6	1.5	1.4	1.2
19	0.0	0.0	0.0	0.0	0.0	0.1	0.0	0.5	0.6	0.9	0.9	1.1	1.1	0.9	0.8	0.7
21	0.0	0.0	0.0	0.0	0.0	0.1	0.3	0.0	0.0	0.0	0.0	0.0	0.0	0.0	0.0	0.0
23	0.0	0.0	0.0	0.0	0.0	0.0	0.2	0.3	0.4	0.6	0.5	0.5	0.4	0.3	0.5	0.7
25	0.0	0.0	0.0	0.0	0.0	0.0	0.0	0.3	0.3	0.4	0.3	0.3	0.2	0.4	0.5	0.7
27	0.0	0.0	0.0	0.0	0.0	0.0	0.1	0.0	0.0	0.0	0.0	0.0	0.0	0.0	0.0	0.0
29	0.0	0.0	0.0	0.0	0.0	0.0	0.1	0.2	0.2	0.2	0.1	0.2	0.3	0.4	0.4	0.4
31	0.0	0.0	0.0	0.0	0.0	0.0	0.0	0.1	0.1	0.1	0.1	0.2	0.3	0.3	0.3	0.3
33	0.0	0.0	0.0	0.0	0.0	0.0	0.1	0.0	0.0	0.0	0.0	0.0	0.0	0.0	0.0	0.0
35	0.0	0.0	0.0	0.0	0.0	0.0	0.0	0.1	0.1	0.1	0.1	0.2	0.2	0.2	0.2	0.3
37	0.0	0.0	0.0	0.0	0.0	0.0	0.0	0.1	0.1	0.1	0.1	0.2	0.1	0.1	0.2	0.3
39	0.0	0.0	0.0	0.0	0.0	0.0	0.0	0.0	0.0	0.0	0.0	0.0	0.0	0.0	0.0	0.0
40	0.0	0.0	0.0	0.0	0.0	0.0	0.0	0.0	0.0	0.0	0.0	0.0	0.0	0.0	0.0	0.0
Total RMS Current (A)	8.2	7.5	9.3	9.9	10.9	12.5	1.4	2.1	2.8	4.0	5.1	7.2	9.5	12.0	15.8	20.8
THD (V) %	0.35 59	0.09 72	0.54 26	0.57 33	0.62 77	0.70 55	0.15 61	0.21 58	0.27 76	0.38 59	0.43 93	0.57 45	0.69 94	0.81 11	0.98 99	1.21 10

Supply Harmonic Analysis (unfiltered)

Assumptions: 5kA short circuit supply capability at 230V, equivalent to 146µH supply impedance
 10kA short circuit supply capability at 400V, equivalent to 127µH supply impedance

$$THD(V) \times 100 = \sqrt{\frac{\sum_{h=2}^{h=40} Q_{h^2}}{Q_{1n}}} \%$$

where Q_{1n} is the rated rms value of the fundamental voltage of the supply transformer.

The results conform to stage 1, stage 2 and stage 3 of the Engineering Recommendation G.5/3 September 1976, Classification 'C': Limits for Harmonics in the UK Electricity Industry.

Drive Type	650															
Motor Power (kW)	0.25	0.37	0.55	0.75	1.1	1.5	0.37	0.55	0.75	1.1	1.5	2.2	3.0	4.0	5.5	7.5
Fundamental Voltage (V)	230	230	230	230	230	230	400	400	400	400	400	400	400	400	400	400
Typical Motor Efficiency %	85	85	85	85	85	85	85	85	85	85	85	85	85	85	85	85
Harmonic No.	RMS Current (A)															
1	1.3	2.0	2.9	3.9	5.7	7.8	0.6	0.9	1.3	1.9	2.6	3.8	5.2	6.9	9.5	12.7
3	1.3	1.9	2.9	3.8	5.5	7.4	0.0	0.0	0.0	0.0	0.0	0.0	0.0	0.0	0.0	0.0
5	1.2	1.9	2.7	3.5	5.0	6.7	0.6	0.9	1.2	1.8	2.4	3.6	4.7	6.3	8.4	11.0
7	1.1	1.7	2.5	3.1	4.4	5.4	0.6	0.9	1.2	1.7	2.3	3.3	4.3	5.7	7.4	9.5
9	1.1	1.6	2.2	2.7	3.7	4.6	0.0	0.0	0.0	0.0	0.0	0.0	0.0	0.0	0.0	0.0
11	1.0	1.4	1.9	2.2	2.9	3.4	0.5	0.8	1.0	1.5	1.9	2.6	3.3	4.2	4.9	5.8
13	0.8	1.2	1.6	1.6	2.1	2.3	0.5	0.7	0.9	1.3	1.6	2.2	2.7	3.4	3.7	4.0
15	0.7	1.0	1.3	1.2	1.4	1.4	0.0	0.0	0.0	0.0	0.0	0.0	0.0	0.0	0.0	0.0
17	0.6	0.8	1.0	0.8	0.8	0.7	0.4	0.6	0.7	0.9	1.2	1.5	1.6	1.9	1.5	1.3
19	0.5	0.7	0.7	0.4	0.4	0.3	0.4	0.5	0.6	0.8	0.9	1.1	1.1	1.3	0.8	0.7
21	0.4	0.5	0.5	0.2	0.2	0.4	0.0	0.0	0.0	0.0	0.0	0.0	0.0	0.0	0.0	0.0
23	0.3	0.3	0.3	0.2	0.3	0.4	0.3	0.4	0.4	0.5	0.5	0.5	0.4	0.4	0.5	0.7
25	0.2	0.2	0.1	0.2	0.3	0.4	0.2	0.3	0.3	0.3	0.4	0.3	0.2	0.3	0.5	0.7
27	0.1	0.1	0.1	0.2	0.3	0.3	0.0	0.0	0.0	0.0	0.0	0.0	0.0	0.0	0.0	0.0
29	0.1	0.1	0.1	0.2	0.2	0.2	0.1	0.2	0.2	0.2	0.1	0.2	0.2	0.3	0.4	0.4
31	0.0	0.1	0.1	0.1	0.1	0.1	0.1	0.1	0.1	0.1	0.1	0.2	0.3	0.3	0.3	0.3
33	0.0	0.1	0.1	0.1	0.1	0.2	0.0	0.0	0.0	0.0	0.0	0.0	0.0	0.0	0.0	0.0
35	0.0	0.1	0.1	0.1	0.1	0.2	0.1	0.1	0.1	0.1	0.1	0.2	0.2	0.2	0.2	0.3
37	0.1	0.1	0.1	0.1	0.1	0.1	0.0	0.1	0.1	0.1	0.1	0.2	0.2	0.1	0.2	0.2
39	0.0	0.1	0.1	0.1	0.1	0.1	0.0	0.0	0.0	0.0	0.0	0.0	0.0	0.0	0.0	0.0
40	0.0	0.0	0.0	0.0	0.0	0.0	0.0	0.0	0.0	0.0	0.0	0.0	0.0	0.0	0.0	0.0
Total RMS Current (A)	3.2	4.8	6.7	8.3	11.7	15.3	1.5	2.1	2.8	4.0	5.1	7.4	9.5	12.4	16.0	20.6
THD (V) %	0.56	0.80	1.03	1.09	1.46	1.77	0.16	0.22	0.28	0.35	0.44	0.58	0.71	0.88	1.01	1.21
	33	16	40	44	11	78	34	09	17	69	44	86	07	96	27	38

CERTIFICATION FOR THE DRIVE

Requirements for EMC Compliance

Earthing Requirements

IMPORTANT: Protective earthing always takes precedence over EMC earthing.

Protective Earth (PE) Connections

Note: *In accordance with installations to EN60204, only one protective earth conductor is permitted at each protective earth terminal contacting point.*

Local wiring regulations may require the protective earth connection of the motor to be connected locally, i.e. not as specified in these instructions. This will not cause shielding problems because of the relatively high RF impedance of the local earth connection.

EMC Earth Connections

For compliance with EMC requirements, the “0V/signal ground” is to be separately earthed. When a number of units are used in a system, these terminals should be connected together at a single, local earthing point.

Control and signal cables connections should be made with screened cables, with the screen connected only at the VSD end. However, if high frequency noise is still a problem, earth screen at the non VSD end via a 0.1 μ F capacitor.

Note: *Connect the screen (at the VSD end) to the VSD protective earth point, and not to the control board terminals.*

Requirements for UL Compliance

Solid-State Motor Overload Protection

These devices provide Class 10 motor overload protection. The maximum internal overload protection level (current limit) is 150% for 30 seconds.

An external motor overload protective device must be provided by the installer where the motor has a full-load ampere rating of less than 50% of the drive output rating.

Short Circuit Rating

The following drives are suitable for use on a circuit capable of delivering not more than:

220-240V product - 5000 RMS Symmetrical Amperes

380-460V product - 10000 RMS Symmetrical Amperes

Solid-State Short-Circuit Protection

These devices are provided with Solid-State Short-Circuit (output) Protection. Branch circuit protection requirements must be in accordance with the latest edition of the National Electrical Code NEC/NFPA-70.

Recommended Branch Circuit Protection

It is recommended that UL Listed (JDDZ) non-renewable cartridge fuses, Class K5 or H; or UL Listed (JDRX) renewable cartridge fuses, Class H, are installed upstream of the drive.

Motor Base Frequency

The motor base frequency rating is 240Hz maximum.

Field Wiring Temperature Rating

Use 75°C Copper conductors only.

Field Wiring Terminal Markings

For correct field wiring connections that are to be made to each terminal refer to Chapter 3: “Installing the Drive” - Wiring Guidelines.

Terminal Tightening Torque

Refer to Chapter 3: “Installing the Drive” – Terminal Tightening Torque.

Terminal/Wire Sizes

North American wire sizes (AWG) are based on NEC/NFPA-70 for ampacities of thermoplastic-insulated (75°C) copper conductors.

Power input and output wire sizes should allow for an ampacity of 125% of the rated input and output amperes for motor branch-circuit conductors as specified in NEC/NFPA-70. Refer to Chapter 3: “Installing the Drive” – Terminal Block Acceptance Sizes.

Input Fuse Ratings

If fitted, fuses should be in accordance with NEC/NFPA-70.

FRAME 1 : 1-Phase (IT/TN), 230V		
Drive Power (kW/hp)	Input Current @ 5kA	Supply Fuse Rating (A) 10 x 38mm
	(A)	
0.25/0.3	4.2	10
0.37/0.5	6.2	10
0.55/0.75	7.9	10
0.75/1.0	10.5	15
FRAME 2 : 1-Phase (IT/TN), 230V		
Drive Power (kW/hp)	Input Current @ 5kA	Supply Fuse Rating (A) 10 x 38mm
	(A)	
1.1/1.5	13.8	20
1.5/2.0	16.0	20
FRAME 2 : 3-Phase (IT/TN), 400V		
Drive Power (kW/hp)	Input Current @ 10kA	Supply Fuse Rating (A) 10 x 38mm
	(A)	
0.37/0.5	2.5	10
0.55/0.75	3.3	10
0.75/1.0	4.1	10
1.1/1.5	5.9	10
1.5/2.0	7.5	10
2.2/3.0	9.4	15
FRAME 3 : 3-Phase (IT/TN), 200V		
Drive Power (kW/hp)	Input Current @ 10kA	Supply Fuse Rating (A) 10 x 38mm
	(A)	
2.2/3.0	9.6	15
3.0/4	12.3	20
4.0/5	16.4	20
FRAME 3 : 3-Phase (IT/TN), 400V		
Drive Power (kW/hp)	Input Current @ 10kA	Supply Fuse Rating (A) 10 x 38mm
	(A)	
3.0/4	11.1	15
4.0/5	13.9	20
5.5/7.5	18.0	25
7.5/10	23.6	30

Field Grounding Terminals

The field grounding terminals are identified with the International Grounding Symbol (IEC Publication 417, Symbol 5019).



Operating Ambient Temperature

Devices are considered acceptable for use in a maximum ambient temperature of 40°C (can be derated up to 50°C).

European Directives and the CE Mark

CE Marking for Low Voltage Directive

When installed in accordance with this manual, the 650 Series AC Drive is CE marked by Eurotherm Drives Ltd in accordance with the low voltage directive (S.I. No. 3260 implements this LVD directive into UK law). An EC Declaration of Conformity (low voltage directive) is included at the end of this chapter.

CE Marking for EMC - Who is Responsible?

Note: *The specified EMC emission and immunity performance of this unit can only be achieved when the unit is installed to the EMC Installation Instructions given in this manual.*

According to S.I. No. 2373 which implements the EMC directive into UK law, the requirement for CE marking this unit falls into two categories:

1. Where the supplied unit has an intrinsic/direct function to the end user, then the unit is classed as **relevant apparatus**. In this situation the responsibility for certification rests with Eurotherm Drives. The Declaration of Conformity is included at the end of this Chapter.
2. Where the supplied unit is incorporated into a higher system/apparatus or machine which includes (at least) the motor, cable and a driven load but is unable to function without this unit, then the unit is classed as a **component**. In this circumstance, the responsibility rests with the manufacturer/supplier/installer of the system/apparatus/machine.

EMC Compliance

All Models All models are compliant with BS EN61800-3.	
Radiated Emissions	EN50081-1(1992) and EN61800-3 unrestricted distribution when mounted inside the specified cubicle, see above. Control and motor cables must be screened and correctly fitted with glands where they exit the cubicle. Control 0V must be connected to protective earth/ground.
Immunity	EN50082-1 (1997), EN61800-3 (1997), EN61000-6-2 (1999)
FRAME 1 & 2: 1-Phase (TN only),	
Conducted Emissions	EN50081-1(1992), EN61800-3 unrestricted distribution, maximum motor cable length: 25m
FRAME 2 & 3 : 3-Phase (TN only)	
Conducted Emissions	EN50081-2(1993), EN61800-3 restricted distribution maximum motor cable length: 25m

Certificates

650 0.25 -1.5kW 200V



EC DECLARATIONS OF CONFORMITY

Date CE marked first applied: 26/07/2001

EMC Directive

In accordance with the EEC Directive 89/336/EEC and amended by 92/31/EEC and 93/68/EEC, Article 10 and Annex 1, (EMC DIRECTIVE)

We Eurotherm Drives Limited, address as below, declare under our sole responsibility that the above Electronic Products when installed and operated with reference to the instructions in the Product Manual (provided with each piece of equipment) is in accordance with the relevant clauses from the following standards:-

BSEN50081-1 (1997), BSEN50082-1# (1997), BSEN61800-3 (1996) and EN61000-6-2 (1999)

Low Voltage Directive

In accordance with the EEC Directive 73/23/EEC and amended by 93/68/EEC, Article 13 and Annex III, (LOW VOLTAGE DIRECTIVE)

We Eurotherm Drives Limited, address as below, declare under our sole responsibility that the above Electronic Products when installed and operated with reference to the instructions in the Product Manual (provided with each piece of equipment), is in accordance with the following standard :-

EN50178 (1998)

Issued for compliance with the EMC Directive when the unit is used as *relevant apparatus*.

The drive is CE marked in accordance with the low voltage directive for electrical equipment and appliances in the voltage range when installed correctly.

MANUFACTURERS DECLARATIONS

EMC Declaration

We Eurotherm Drives Limited, address as below, declare under our sole responsibility that the above Electronic Products when installed and operated with reference to the instructions in the Product Manual (provided with each piece of equipment) is in accordance with the relevant clauses from the following standards:-

BSEN50081-1 (1997), BSEN50082-1# (1997), BSEN61800-3 (1996) and EN61000-6-2 (1999)

Machinery Directive

The above Electronic Products are components to be incorporated into machinery and may not be operated alone.

The complete machinery or installation using this equipment may only be put into service when the safety considerations of the Directive 89/392/EEC are fully adhered to.

Particular reference should be made to EN60204-1 (Safety of Machinery - Electrical Equipment of Machines).

All instructions, warnings and safety information of the Product Manual must be adhered to.

This is provided to aid your justification for EMC compliance when the unit is used as a component.

Since the potential hazards are mainly electrical rather than mechanical, the drive does not fall under the machinery directive. However, we do supply a manufacturer's declaration for when the drive is used(as a component) in machinery.

Dr Martin Payn (Conformance Officer)

Compliant with these immunity standards without specified EMC filters.

EUROTHERM DRIVES LIMITED

An Invensys Company

NEW COURTWICK LANE, LITTLEHAMPTON, WEST SUSSEX BN17 7RZ

TELEPHONE: +44(0)1903 737000 FAX: +44(0)1903 737100

Registered Number: 1159876 England. Registered Office: Invensys House, Carlisle Place, London, SW1P 1BX

File Name: C:\Documents and Settings\jrich\My Documents\Temp docs\hp467607.919 © 1999 EUROTHERM DRIVES LIMITED

ISS:	DATE	DRN: J.Mc	CHKD: MP	DRAWING NUMBER: HK467607.919	
A	20/01/01	<p>EUROTHERM DRIVES</p>		TITLE:	SHT 4
				Declarations of Conformity	OF
					1 SHTS

650 0.37 -7.5kW 400V



EC DECLARATIONS OF CONFORMITY

Date CE marked first applied: 26/07/2001

EMC Directive

In accordance with the EEC Directive 89/336/EEC and amended by 92/31/EEC and 93/68/EEC, Article 10 and Annex I, (EMC DIRECTIVE)

We Eurotherm Drives Limited, address as below, declare under our sole responsibility that the above Electronic Products when installed and operated with reference to the instructions in the Product Manual (provided with each piece of equipment) is in accordance with the relevant clauses from the following standards:-

BSEN50081-1 (1997), BSEN50082-1# (1997), BSEN61800-3 (1996) and EN61000-6-2 (1999)

Low Voltage Directive

In accordance with the EEC Directive 73/23/EEC and amended by 93/68/EEC, Article 13 and Annex III, (LOW VOLTAGE DIRECTIVE)

We Eurotherm Drives Limited, address as below, declare under our sole responsibility that the above Electronic Products when installed and operated with reference to the instructions in the Product Manual (provided with each piece of equipment), is in accordance with the following standard :-

EN50178 (1998)

Issued for compliance with the EMC Directive when the unit is used as *relevant apparatus*.

The drive is CE marked in accordance with the low voltage directive for electrical equipment and appliances in the voltage range when installed correctly.

MANUFACTURERS DECLARATIONS

EMC Declaration

We Eurotherm Drives Limited, address as below, declare under our sole responsibility that the above Electronic Products when installed and operated with reference to the instructions in the Product Manual (provided with each piece of equipment) is in accordance with the relevant clauses from the following standards:-

BSEN50081-1 (1997), BSEN50082-1# (1997), BSEN61800-3 (1996) and EN61000-6-2 (1999)

Machinery Directive

The above Electronic Products are components to be incorporated into machinery and may not be operated alone.

The complete machinery or installation using this equipment may only be put into service when the safety considerations of the Directive 89/392/EEC are fully adhered to.

Particular reference should be made to EN60204-1 (Safety of Machinery - Electrical Equipment of Machines).

All instructions, warnings and safety information of the Product Manual must be adhered to.

This is provided to aid your justification for EMC compliance when the unit is used as a component.

Since the potential hazards are mainly electrical rather than mechanical, the drive does not fall under the machinery directive. However, we do supply a manufacturer's declaration for when the drive is used (as a component) in machinery.

Dr Martin Payn (Conformance Officer)

Compliant with these immunity standards without specified EMC filters.

EUROTHERM DRIVES LIMITED

An Invensys Company

NEW COURTWICK LANE, LITTLEHAMPTON, WEST SUSSEX BN17 7RZ

TELEPHONE: +44(0)1903 737000 FAX: +44(0)1903 737100

Registered Number: 1159876 England. Registered Office: Invensys House, Carlisle Place, London, SW1P 1BX

File Name: C:\Documents and Settings\jrich\My Documents\Temp docs\hp467607.919 © 1999 EUROTHERM DRIVES LIMITED

ISS:	DATE	DRN: J.Mc	CHKD: MP	DRAWING NUMBER: HK467607.919	
A	20/01/01			TITLE:	SHT 5 OF 1 SHTS
				Declarations of Conformity	

SERIAL COMMUNICATIONS

Connection to the P3 Port

IMPORTANT: The drive **MUST be earthed**. Failure to do so could damage your communications ports.

The port is an un-isolated RS232, 19200 Baud. The P3 port is located under the terminal cover and is used only by the Remote Keypad.

P3 Port

A standard P3 lead is used to connect to the drive.

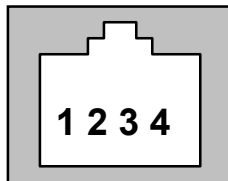

P3 Port Pin	Lead	Signal
1	Black	0V
2	Red	5V
3	Green	TX
4	Yellow	RX

Note: There is 5V present on pin 2 of the P3 port - do not connect this to your PC.

APPLICATIONS

The Default Application

The drive is supplied with 6 Applications, Application 0 to Application 5. Each Application recalls a pre-programmed structure of internal links when it is loaded.

DEFAULT

- Application 0 will not control a motor. Loading Application 0 removes all internal links.
- Application 1 is the factory default application, providing for basic speed control
- Application 2 supplies speed control using a manual or auto setpoint
- Application 3 supplies speed control using preset speeds
- Application 4 is a set-up providing speed control with Raise/Lower Trim
- Application 5 supplies speed control with Run Forward/Run Reverse

IMPORTANT: Parameter values are not changed by loading a new Application. Refer to Chapter 4: The Keypad – Special Menu Features to reset the drive to factory default values which are suitable for most applications.

How to Load an Application

In the **PRG** menu, go to **P I** and press the **M** key.

The Applications are stored in this menu.

Use the **▲** **▼** keys to select the appropriate Application by number.

Press the **E** key to load the Application.

Application Description

Control Wiring for Applications

(default)

APPLICATION 1 Basic Speed Control	APPLICATION 2 Manual/Auto	APPLICATION 3 Presets	APPLICATION 4 Raise/Lower	APPLICATION 5 PID
Not Stop	Direction	Preset Select	Reset	Not Stop
Jog	Select	Preset Select	Lower	Jog
Direction	Auto Run	Preset Select	Raise	Direction
Run	Manual Run	Run	Run	Run
+24V	+24V	+24V	+24V	+24V
AOUT1	AOUT1	AOUT1	AOUT1	AOUT1
+10V REF	+10V REF	+10V REF	+10V REF	+10V REF
Feedback	Auto Setpoint	Preset 0	not used	Feedback
Setpoint	Manual Setpoint	Preset 0	not used	Setpoint
0V	0V	0V	0V	0V
Health	Health	Health	Health	Health
				RL1A
				RL1B

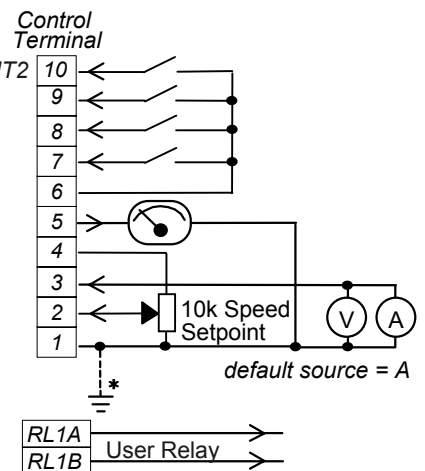

Key to Application Diagrams

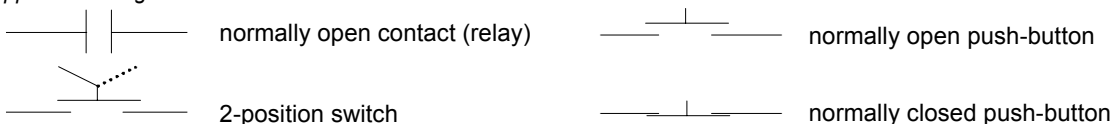

Application 1 : Basic Speed Control

STANDARD PARAMETERS

- p1 Application
- p2 Max speed
- p3 Min speed
- p4 Accel time
- p5 Decel time
- p6 Motor rated current
- p7 Base frequency
- p8 Jog setpoint
- p9 Stop mode
- p11 V/F shape
- p12 HVAC ratings
- p13 Fixed boost, (VF only)
- p99 Password

DIAGNOSTICS

- Frequency Hz
- Speed Setpt %
- DC Link Volts V
- Motor Current A

Application 1: Basic Speed Control

IDEAL FOR GENERAL PURPOSE APPLICATIONS,
CONSTANT TORQUE AND VARIABLE TORQUE

P1 APPLICATION = 1

Italic text indicates Default

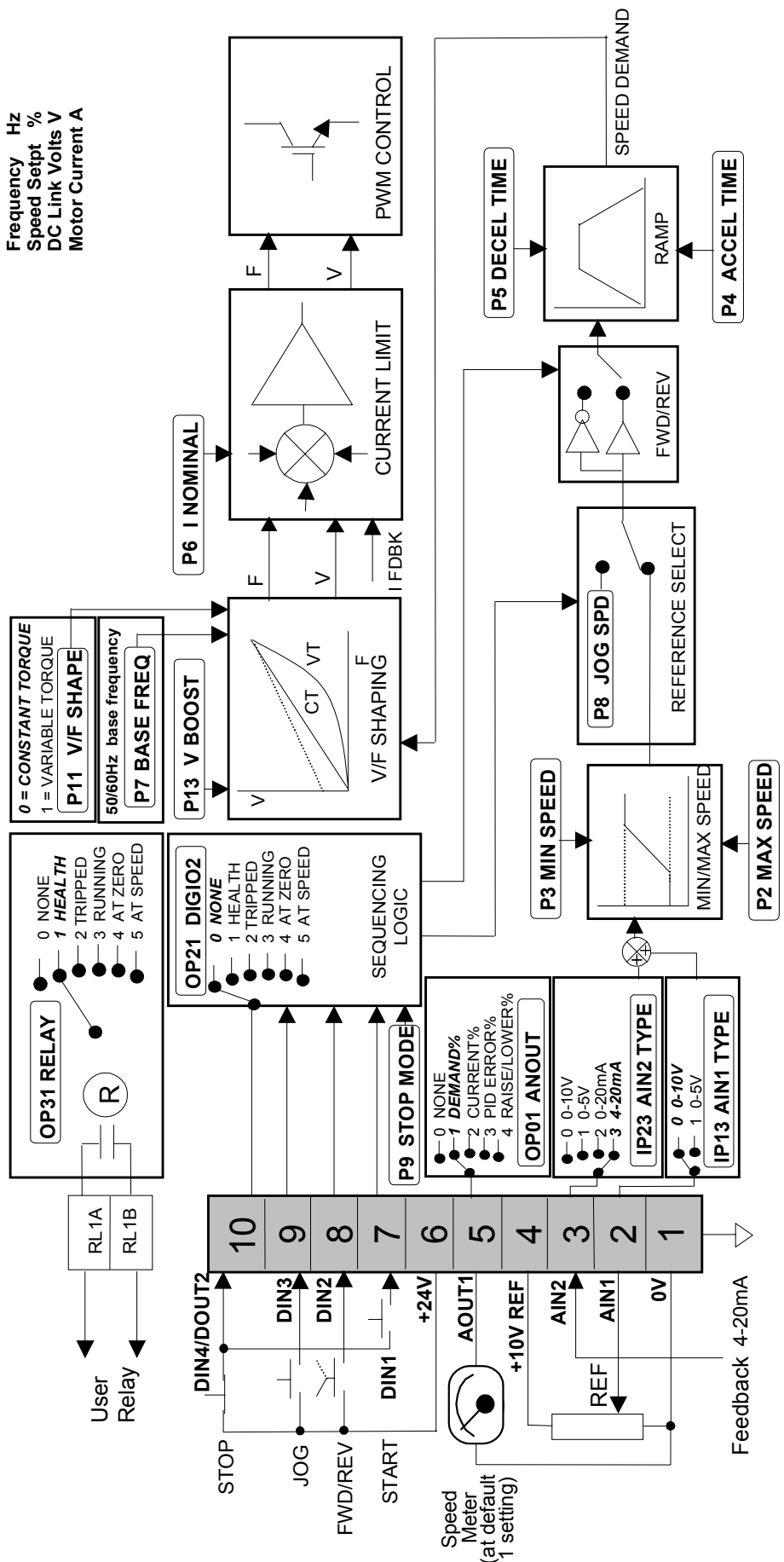
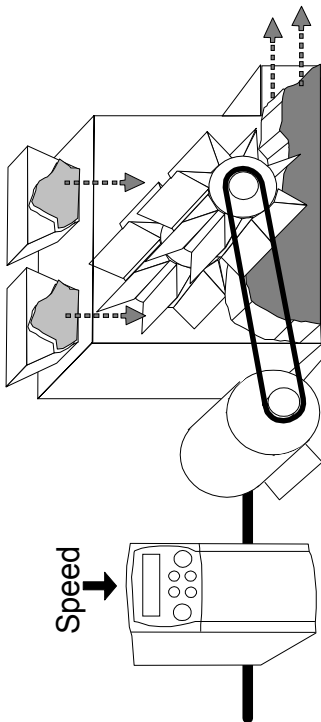

Application 2 : Auto/Manual Control

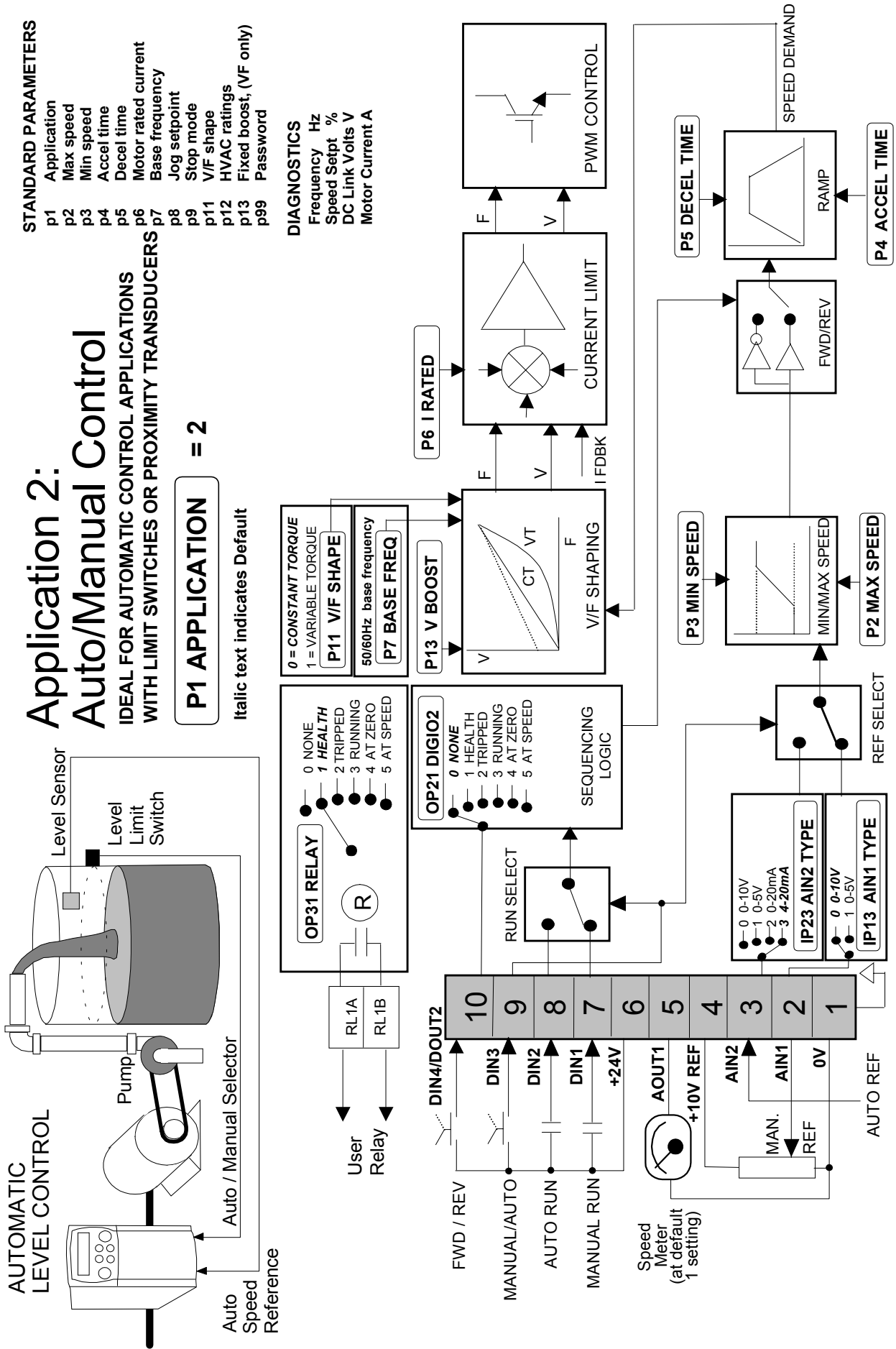

- STANDARD PARAMETERS**
- p1 Application
 - p2 Max speed
 - p3 Min speed
 - p4 Accel time
 - p5 Decel time
 - p6 Motor rated current
 - p7 Base frequency
 - p8 Jog setpoint
 - p9 Stop mode
 - p11 V/F shape
 - p12 HVAC ratings
 - p13 Fixed boost, (VF only)
 - p99 Password

Application 2: Auto/Manual Control

IDEAL FOR AUTOMATIC CONTROL APPLICATIONS
WITH LIMIT SWITCHES OR PROXIMITY TRANSDUCERS

P1 APPLICATION = 2

Italic text indicates Default

- DIAGNOSTICS**
- Frequency Hz
 - Speed Setpt %
 - DC Link Volts V
 - Motor Current A

- 0 = CONSTANT TORQUE
- 1 = VARIABLE TORQUE
- P11 V/F SHAPE**
- 50/60Hz base frequency
- P7 BASE FREQ**

- P13 V BOOST**
- P6 I RATED**

- OP21 DIGIO2**
- 0 NONE
 - 1 HEALTH
 - 2 TRIPPED
 - 3 RUNNING
 - 4 AT ZERO
 - 5 AT SPEED
- SEQUENCING LOGIC**

- OP31 RELAY**
- 0 NONE
 - 1 HEALTH
 - 2 TRIPPED
 - 3 RUNNING
 - 4 AT ZERO
 - 5 AT SPEED

- 0 0-10V
- 1 0-5V
- 2 0-20mA
- 3 4-20mA
- IP23 AIN2 TYPE**
- 0 0-10V
- 1 0-5V
- IP13 AIN1 TYPE**

Application 3 Preset Speeds

Application 3: Preset Speeds

IDEAL FOR APPLICATIONS REQUIRING
MULTIPLE DISCRETE SPEED LEVELS

P1 APPLICATION = 3

Italic text indicates Default

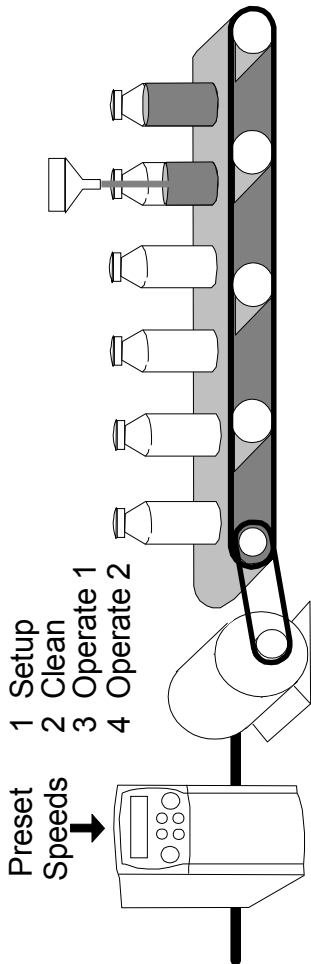

STANDARD PARAMETERS

- p1 Application
- p2 Max speed
- p3 Min speed
- p4 Accel time
- p5 Decel time
- p6 Motor rated current
- p7 Base frequency
- p8 Jog setpoint
- p9 Stop mode
- p11 V/F shape
- p12 HVAC ratings
- p13 Fixed boost, (VF only)
- p99 Password

DIAGNOSTICS

- Frequency Hz
- Speed Setpt %
- DC Link Volts V
- Motor Current A

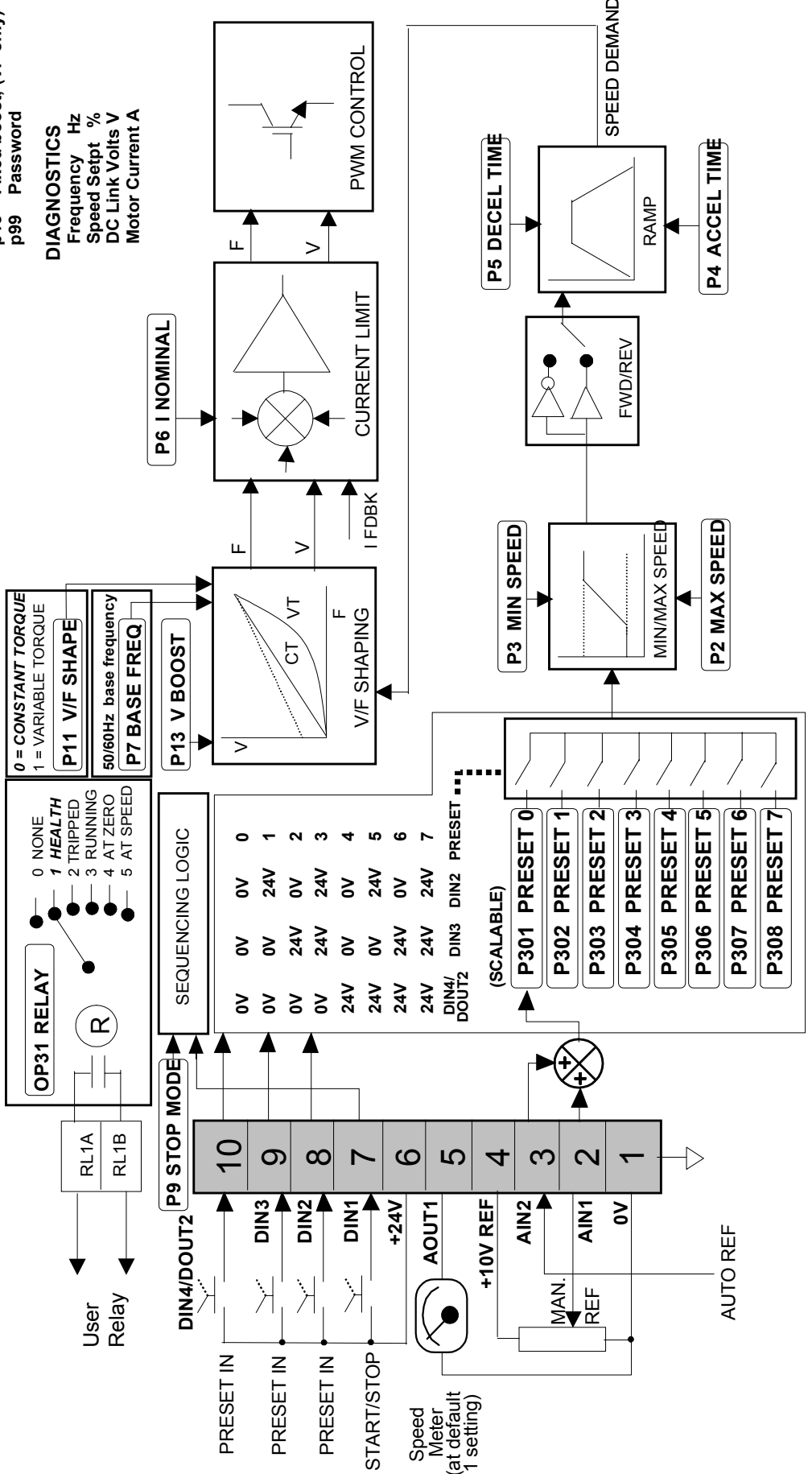

Application 4 : Raise/Lower

STANDARD PARAMETERS

- p1 Application
- p2 Max speed
- p3 Min speed
- p4 Accel time
- p5 Decel time
- p6 Motor rated current
- p7 Base frequency
- p8 Jog setpoint
- p9 Stop mode
- p11 V/F shape
- p12 HVAC ratings
- p13 Fixed boost, (VF only)
- p99 Password

DIAGNOSTICS

- Frequency Hz
- Speed Setpt %
- DC Link Volts V
- Motor Current A

Application 4: Raise/Lower

IDEAL FOR APPLICATIONS REQUIRING
SPEED CONTROL FROM MULTIPLE LOCATIONS

P1 APPLICATION = 4

Italic text indicates Default

- 0 = CONSTANT TORQUE*
- 1 = VARIABLE TORQUE*
- P11 V/F SHAPE**
- 50/60Hz base frequency
- P7 BASE FREQ**

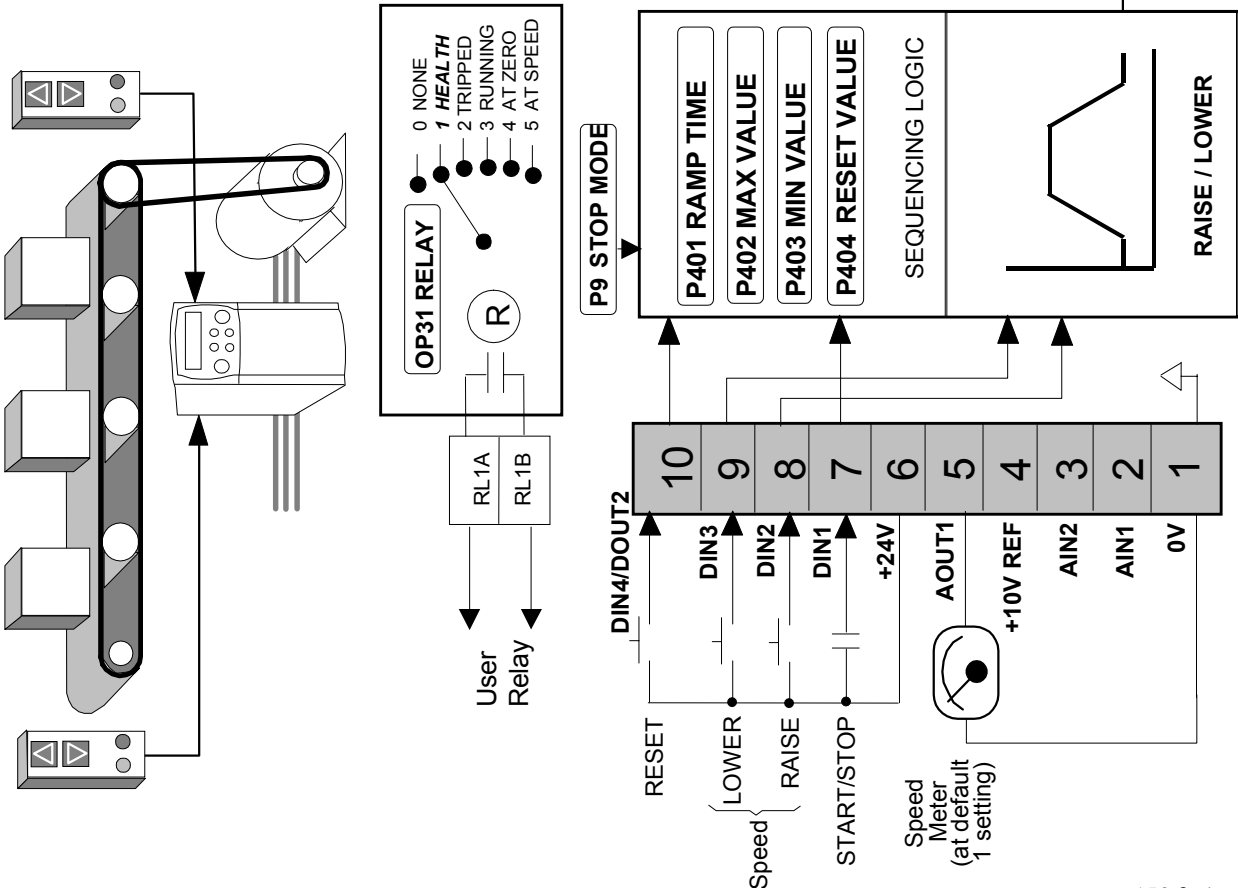

Application 5 : PI Control

Application 5: PI Control

EASY TUNING FOR SETPOINT/FEEDBACK CONTROL
APPLICATIONS REGULATING VOLUME OR PRESSURE,
SUCH AS AIR HANDLING OR PUMPING

P1 APPLICATION = 5

Italic text indicates Default

STANDARD PARAMETERS

p1	Application
p2	Max speed
p3	Min speed
p4	Accel time
p5	Decel time
p6	Motor rated current
p7	Base frequency
p8	Jog setpoint
p9	Stop mode
p11	V/F shape
p12	HVAC ratings
p13	Fixed boost, (VF only)
p99	Password

DIAGNOSTICS

Frequency	Hz
Speed Setpt	%
DC Link Volts	V
Motor Current	A

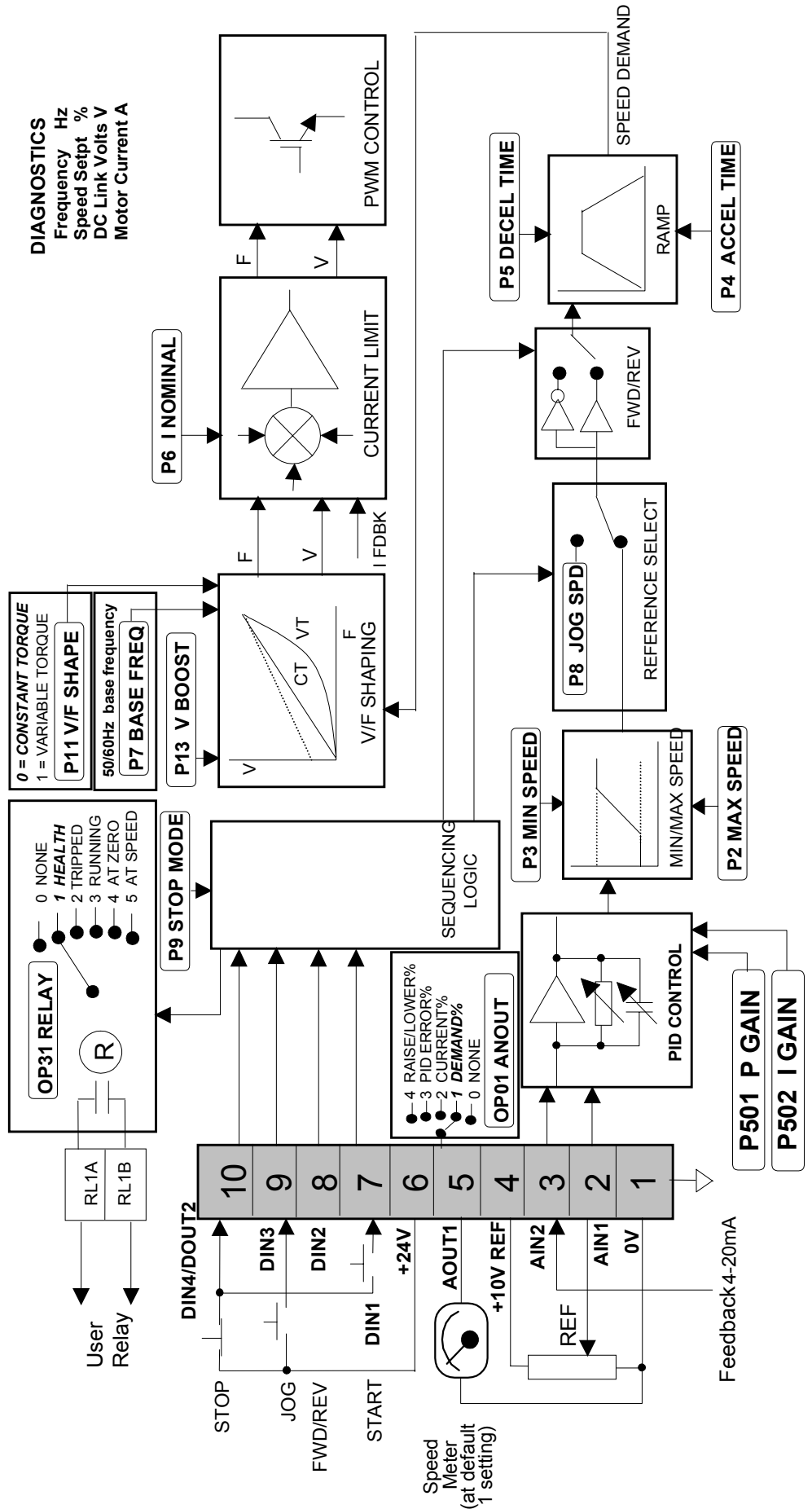
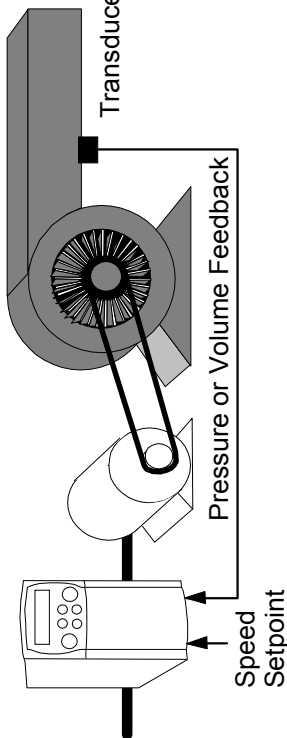

ISS.	MODIFICATION	ECN No.	DATE	DRAWN	CHK'D
A	First issue of HA464828U002, software version 3.x. Digital printing.	650	13/2/02	CM	JA
FIRST USED ON		MODIFICATION RECORD 650 Series AC Drive			
 EUROTHERM DRIVES		DRAWING NUMBER ZZ464828U002			SHT. 1 OF 1