

Datasheet - ZQ 900-22

Pull-wire emergency stop switches / ZQ 900



Preferred typ



- Metal enclosure
- one-side operation / wire up to 75 m long
- Release push button
- Position indicator
- Robust design
- Large wiring compartment
- Twisting of towing eye not possible
- External watertight collar
- wire pull and breakage detection
- 3 cable entries M 20 x 1.5

(Minor differences between the printed image and the original product may exist!)

Ordering details

Product type description	ZQ 900-22
Article number	101184329
EAN Code	4030661332758
eCl@ss	27-37-12-90

Approval

Approval

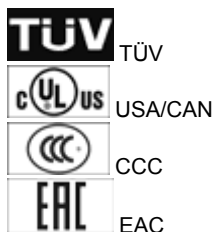

Classification

Standards	EN ISO 13849-1
B10d Normally-closed contact (NC)	100.000
Mission time	20 Years
notice	$MTTF_d = \frac{B_{10d}}{0,1 \times n_{op}}$ $n_{op} = \frac{d_{op} \times h_{op} \times 3600 \text{ s/h}}{t_{cycle}}$

Global Properties

Permanent light	ZQ 900
Standards	IEC/EN 60947-5-1, IEC/EN 60947-5-5, EN ISO 13850
Compliance with the Directives (Y/N) 	Yes
Materials	
- Material of the housings	zinc die-cast
- Material of the cover	Plastic, thermoplastic
- Material of the contacts	Silver
Housing coating	painted
Weight	1260
Emergency-Stop button (Y/N)	No

Mechanical data

Design of electrical connection	Screw connection
Cable section	
- Min. Cable section	0,75
- Max. Cable section	2.5
Mechanical life	> 1.000.000 operations
notice	All indications about the cable section are including the conductor ferrules.
Indicator lamp (Y/N)	optional
Length of wire	max. 75 m

Ambient conditions

Ambient temperature	
- Min. environmental temperature	-25
- Max. environmental temperature	+70
Protection class	IP67 to IEC/EN 60529

Electrical data

Design of control element	Normally open contact (NO), Opener (NC)
Switching principle	Snap switch element
Number of auxiliary contacts	2
Number of safety contacts	2
Rated impulse withstand voltage U_{imp}	6 kV
Rated insulation voltage U_i	500 V
Thermal test current I_{the}	6 A
Utilisation category	AC-15: 230 V / 4 A, DC-13: 24 V / 1 A
Max. fuse rating	6 A gG D-fuse

Dimensions

Dimensions of the sensor	
- Width of sensor	71.5
- Height of sensor	220.3 mm up 236.3 mm
- Length of sensor	69.7

notice

For lengths of over 10 m, intermediate wire supports must be installed every 3 to 5 m.

Recommended cable lengths for pull-wire Emergency-Stop switches in relation to the range of ambient temperature.

The screwed G24-M20 indicator lamp must be ordered separately, see accessories.

As the thimbles are subject to deformation in case of wire pull, the wire should be pulled several times after fitting. After that, the wire must be re-tensioned using the eyebolt or the tensioner.

Indication legend

A = Position indicator

B = Emergency-Stop button

C = reset button

1 = Wire rope

2 = Eyebolt

3 = nut

4 = Wire clamp

5 = Tensioning Jack

6 = Wire thimble

7 = shackle

8 = rope tensioner

Diagram

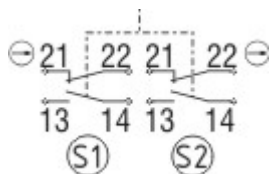



Note Diagram

 positive break NC contact

 active

 no active

 Normally-open contact

 Normally-closed contact

Ordering suffix

The applicable ordering suffix is added at the end of the part number of the safety switch.

Order example: ZQ 900-22-**2828**

...-**2828**

reduced spring force ("65 N)
max. Length of wire 10 m

Ordering code

ZQ 900-(1)(2)

(1)

11 1 Normally open contact (NO) / 1 Opener (NC)

13 1 Normally open contact (NO) / 3 Opener (NC)

22 2 Normally open contact (NO) / 2 Opener (NC)

02 2 Opener (NC)

04 4 Opener (NC)

(2)

without

without Emergency-Stop button

N

with Emergency-Stop button

Documents

Operating instructions and Declaration of conformity (es) 355 kB, 31.03.2014

Code: mrl_zq900_es

Operating instructions and Declaration of conformity (en) 397 kB, 12.12.2016

Code: mrl_zq900_en

Operating instructions and Declaration of conformity (de) 388 kB, 12.12.2016

Code: mrl_zq900_de

Operating instructions and Declaration of conformity (it) 355 kB, 04.02.2014

Code: mrl_zq900_it

Operating instructions and Declaration of conformity (fr) 359 kB, 31.03.2014

Code: mrl_zq900_fr

Operating instructions and Declaration of conformity (cs) 406 kB, 28.07.2015

Code: mrl_zq900_cs

Operating instructions and Declaration of conformity (pt) 360 kB, 25.01.2016

Code: mrl_zq900_pt

Operating instructions and Declaration of conformity (nl) 354 kB, 31.03.2014

Code: mrl_zq900_nl

Operating instructions and Declaration of conformity (jp) 634 kB, 04.02.2014

Code: mrl_zq900_jp

Operating instructions and Declaration of conformity (cn) 611 kB, 14.02.2017

Code: SISSmrl_zq900_cn

Operating instructions and Declaration of conformity (pl) 396 kB, 31.03.2014

Code: mrl_zq900_pl

BG-test certificate (de, en) 295 kB, 26.11.2007

Code: z_zq9p01

Brochure (it) 391 kB, 09.06.2006

Code: b_900p05

Brochure (fr) 415 kB, 26.07.2007

Code: b_900p03

Brochure (pt) 391 kB, 12.09.2006

Code: b_900p10

Brochure (es) 391 kB, 09.06.2006

Code: b_900p09

Brochure (en) 389 kB, 09.06.2006

Code: b_900p02

Brochure (de) 390 kB, 09.06.2006

Code: b_900p01

CCC certification (en) 836 kB, 15.08.2016

Code: q_zq9p02

CCC certification (cn) 834 kB, 15.08.2016

Code: q_zq9p03

EAC certification (ru) 844 kB, 05.10.2015

Code: q_6037p17_ru

Images

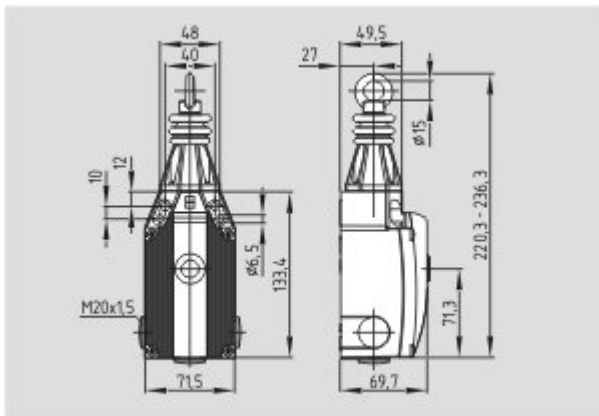

Dimensional drawing (basic component)

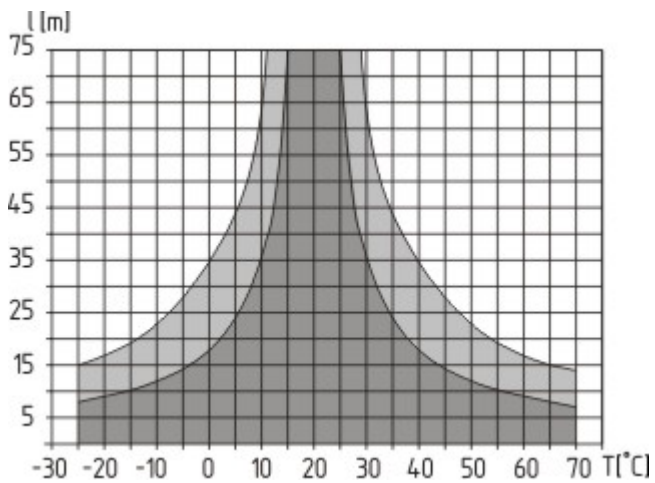

Characteristic curve

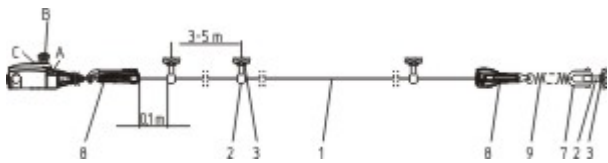

Operating principle

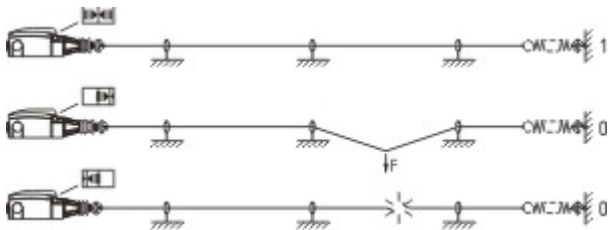

Operating principle

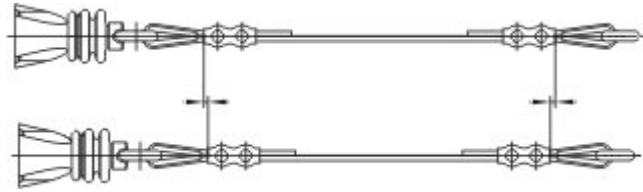

Operating principle

System components

Accessories



101162986 - Eyebolt BM 8 x 70



101084928 - Eyebolt BM 10 x 40



101203477 - Wire clamp 3 mm NIRO



101203478 - Wire clamp 5 mm NIRO



101190917 - Duplex wire clamp 3 mm NIRO

• for Wire rope \varnothing 3 mm



101196043 - Egg-shaped wire clamp GR 3

- for Wire rope \varnothing 3 mm



101203472 - WIRE THIMBLE 3 mm NIRO

- for Wire rope \varnothing 3 mm
- to DIN 6899



101203476 - WIRE THIMBLE 5 mm NIRO

- for Wire rope \varnothing 5 mm
- to DIN 6899



101192433 - PULLEY

- for Wire rope \varnothing 3 mm
- To guide the wire rope where the path is not a straight line



101087930 - TENSIONING JACK M6

- For exact adjustment of the tension of the wire rope
- to DIN 1480



101186696 - TENSION SPRING RZ-2041

- To maintain the reaction force



101186490 - SHACKLE NIRO

- Shackle for fixing the wire rope to the eyebolt



101078670 - WIRE ROPE 5 mm

- With red PVC sheath
- \varnothing 5 mm total
- Steel core \varnothing 3 mm
- Quantity: Meter



103003628 - WIRE UNIT COMPLETE 5 m

- Ready-to-fit
- With red PVC sheath



103003629 - WIRE UNIT COMPLETE 10 m

- Ready-to-fit
- With red PVC sheath



103003865 - WIRE UNIT COMPLETE 15 m

- Ready-to-fit
- With red PVC sheath



103003866 - WIRE UNIT COMPLETE 20 m

- Ready-to-fit
- With red PVC sheath



103003630 - WIRE UNIT COMPLETE 30 m

- Ready-to-fit
- With red PVC sheath



103003867 - WIRE UNIT COMPLETE 40 m

- Ready-to-fit
- With red PVC sheath



103003631 - WIRE UNIT COMPLETE 50 m

- Ready-to-fit
- With red PVC sheath

101186704 - rope tensioner S 900

- Smooth adjustment
- Only one tool
- Antiskid
- Time-saving



- Ergonomic
- No risk of injury



101150877 - Indicator lamp G24-M20

- red LED and green LED
- To be screwed in cable entries M 20 x 1.5
- white lens (clear)

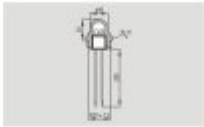

101186263 - Indicator lamp G24-M20 Orange

- amber LED, white lens (clear)
- To be screwed in cable entries M 20 x 1.5



101193805 - MP ZQ/TQ900-441/75

- Mounting plate set for ZQ 900 / TQ 900



103006011 - ACC-CGLD-M20-MS

- cable gland M20
- Metal film



103006009 - ACC-BPL-M20-MS

- Locking screw M20
- Metal film