

Datasheet - AZM 190-11/01RK-M20 24 VDC



Solenoid interlock / AZM 190 / TZK



- thermoplastic enclosure
- Interlock with protection against incorrect locking.
- Long life
- 89 mm x 178 mm x 41 mm
- Actuating head can be repositioned by 4 x 90°
- 2 cable entries M 20 x 1.5
- Manual release
- Wiring compartment
- Slim design, particularly suitable for fitting on hinged doors, aluminium profiles and fencing
- Sealing mechanism to prevent the ingress of dirt
- Cut clamp termination

(Minor differences between the printed image and the original product may exist!)

Ordering details

Product type description	AZM 190-11/01RK-M20 24 VDC
Article number	1155668
EAN code	4030661289939

Approval

Approval



Classification

Standards	EN ISO 13849-1
B _{10d} Opener (NC)	2.000.000
Mission time	20 Years
notice	$MTTF_d = \frac{B_{10d}}{0,1 \times n_{op}}$ $n_{op} = \frac{d_{op} \times h_{op} \times 3600 \text{ s/h}}{t_{zyklus}}$

Global Properties

Product name	AZM 190
--------------	---------

Standards	EN 60947-5-1, BG-GS-ET-19
Compliance with the Directives (Y/N) 	Yes
Number of actuating directions	4 piece
Active principle	electromechanical
Duty cycle	Magnet 100 %
Materials	
- Material of the housings	Plastic, glass-fibre reinforced thermoplastic
- Material of the contacts	Silver
Housing coating	None

Mechanical data

Connection type	Screw connection
Cable section	
- Min. Cable section	1 x 0,5 mm ²
- Max. Cable section	1 x 1.5 mm ²
Mechanical life	2.000.000 operations
Emergency unlocking device (Y/N)	No
Manual release (Y/N)	Yes
- front	
Emergency release (Y/N)	No
Latching force	20 N
Positive break force	20 N
positive break travel	2 x 3.5 mm
Clamping force F _{max}	1950 N
notice	All indications about the cable section are including the conductor ferrules.

Ambient conditions

Ambient temperature	
- Min. environmental temperature	0°C
- Max. environmental temperature	+ 50°C
Protection class	IP67 to IEC/EN 60529

Electrical data

Design of control element	Normally open contact (NO), Opener (NC)
Switching principle	Creep circuit element
Number of auxiliary contacts	1 piece
Number of safety contacts	2 piece
Power to unlock	Yes
Power to lock	No
Rated control voltage U _s	24 VDC
Power consumption	max. 8.5 W
Rated impulse withstand voltage U _{imp}	2.5 kV
Rated insulation voltage U _i	250 V
Thermal test current I _{the}	10 A
Utilisation category	AC-15: 230 V / 8 A, DC-13: 24 V / 5 A
Max. fuse rating	10 A gG D-fuse

ATEX

Explosion protection categories for gases	None
---	------

Miscellaneous data

Applications



hinged safety guard

Dimensions

Dimensions of the sensor

- Width of sensor	89 mm
- Height of sensor	178 mm
- Length of sensor	41 mm

notice

Manual release

- For manual release using triangular key M3 (included in delivery)
- For maintenance, installation, etc.

Diagram

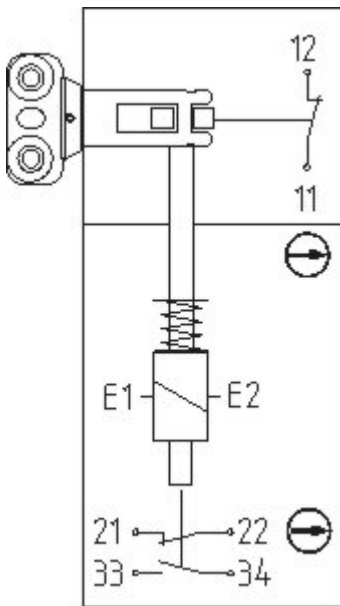

Note Diagram

positive break NC contact

active

no active



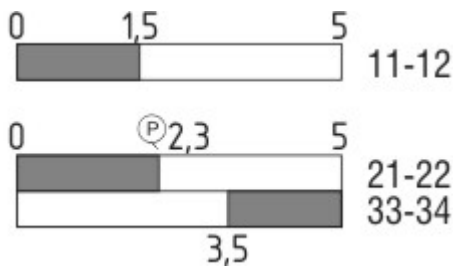

Normally-open contact

Normally-closed contact

Switch travel diagram



Notes Switch travel diagram

-  Contact closed
-  Contact open
-  Setting range
-  Break point
-  Positive opening sequence/- angle

VS adjustable range of NO contact

VÖ adjustable range of NC contact

N after travel

Ordering code

AZM 190-(1)RK(2)(3)-(4)

(1)

- 11/01** 1 Normally open contact (NO), 1 Opener (NC) / 1 Opener (NC)
- 11/10** 1 Normally open contact (NO), 1 Opener (NC) / 1 Normally open contact (NO)
- 02/10** 2 Opener (NC) / 1 Normally open contact (NO)
- 02/01** 2 Opener (NC) / 1 Opener (NC)

(2)

without Power to unlock

A Power to lock

(3)

without Manual release

N Emergency release

(4)

24VDC Us: 24 VDC

24VAC Us: 24 VAC

48VAC Us: 48 VAC

110VAC Us: 110 VAC

230VAC Us: 230 VAC

Documents

Operating instructions and Declaration of conformity (jp) 399 kB, 13.01.2011

[http://127.0.0.1/Bilddata/Azm/Pdf/Azm190/bedien/Japanisch \(Japan\)/mrl_azm190_jp.pdf](http://127.0.0.1/Bilddata/Azm/Pdf/Azm190/bedien/Japanisch (Japan)/mrl_azm190_jp.pdf)

Operating instructions and Declaration of conformity (es) 433 kB, 11.01.2011

http://127.0.0.1/Bilddata/Azm/Pdf/Azm190/bedien/ES/mrl_azm190_es.pdf

Operating instructions and Declaration of conformity (fr) 433 kB, 11.01.2011

http://127.0.0.1/Bilddata/Azm/Pdf/Azm190/bedien/FR/mrl_azm190_fr.pdf

Operating instructions and Declaration of conformity (it) 416 kB, 11.01.2011

http://127.0.0.1/Bilddata/Azm/Pdf/Azm190/bedien/IT/mrl_azm190_it.pdf

Operating instructions and Declaration of conformity (nl) 438 kB, 11.01.2011

http://127.0.0.1/Bilddata/Azm/Pdf/Azm190/bedien/NL/mrl_azm190_nl.pdf

Operating instructions and Declaration of conformity (de) 622 kB, 11.01.2011

http://127.0.0.1/Bilddata/Azm/Pdf/Azm190/bedien/DE/mrl_azm190_de.pdf

Operating instructions and Declaration of conformity (en) 579 kB, 11.01.2011

http://127.0.0.1/Bilddata/Azm/Pdf/Azm190/bedien/EN/mrl_azm190_en.pdf

BG-test certificate (en) 104 kB, 01.06.2010

http://127.0.0.1/Bilddata/Azm/Pdf/Azm190/baumuste/z_m19p02.pdf

BG-test certificate (de) 105 kB, 01.06.2010

http://127.0.0.1/Bilddata/Azm/Pdf/Azm190/baumuste/z_m19p01.pdf

Gost certification (ru) 1 MB, 21.06.2007

http://127.0.0.1/Bilddata/Azm/Pdf/Azm161/zertifikat/q_azmp01.pdf

Images

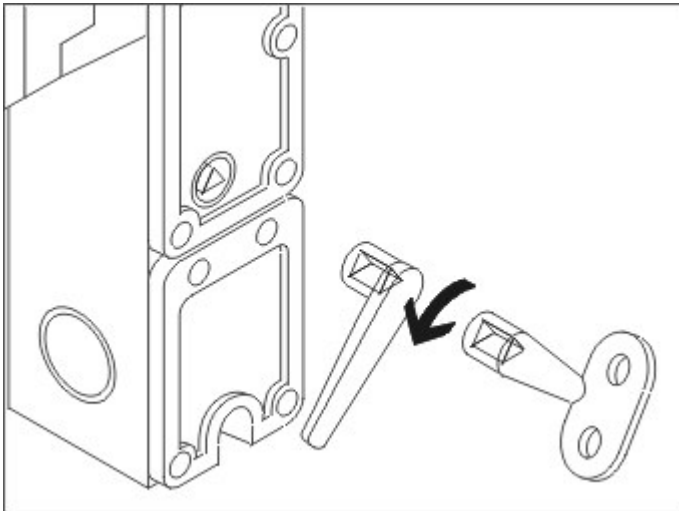

Detail photo

System components

Actuator



1144771 - AZM 190-B1

- Compensation for tolerances by means of rubber buffers
-



1144774 - AZM 190-B3/15



1144775 - AZM 190-B3/1X7,5



1144773 - AZM 190-B3/2X15

- For very small actuating radii in line with or at 90° to the plane of the actuator



1144772 - AZM 190-B5

- Particularly suitable for front mounting e.g. on hinged guards

Accessories

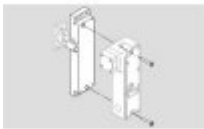

1144776 - MP 190 MOUNTING PLATE

- For simple mounting of an AZM 190 on profile systems



1144779 - TRIANGULAR KEY M3-A

- For manual release
- angled triangular key