

Datasheet - BPS 33

Safety sensors / BNS 33 / Actuator



(Minor differences between the printed image and the original product may exist!)

Ordering details

Product type description	BPS 33
Article number	1107771
EAN code	4030661272849

Global Properties

Product name	Magnet
Materials	
- Material of the housings	Plastic
Weight	25 g

Dimensions

Dimensions of the actuators	
- Width of the actuator	88 mm
- Height of the actuator	25 mm
- Length of the actuator	13 mm

Included in delivery

tamperproof screws	2 piece
--------------------	---------

Images

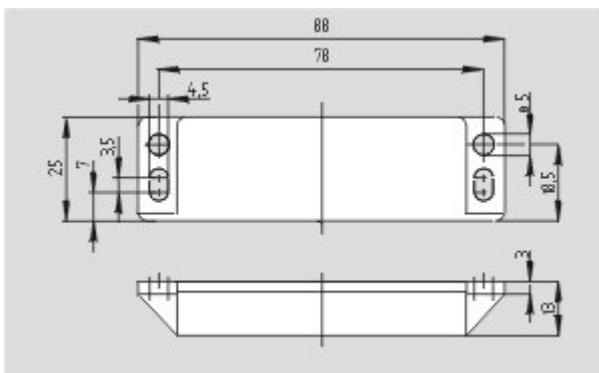

Dimensional drawing (miscellaneous)

K.A. Schmersal GmbH, Möddinghofe 30, D-42279 Wuppertal

The data and values have been checked thoroughly. Technical modifications and errors excepted.

Generiert am 10.02.2011 - 11:15:23h Kasbase 1.4.0 DBI