

# Product datasheet

Specifications



variable speed drive, ATV320, 2.2 kW, 380...500 V, 3 phases, compact

Local distributor code: 403009336 ATV320U22N4C

## Main

Range of product	Altivar Machine ATV320
Product or component type	Variable speed drive
Product specific application	Complex machines
Variant	Standard version With disconnect switch
Format of the drive	Compact
Mounting mode	Wall mount
Communication port protocol	Modbus serial CANopen
Option card	Communication module, CANopen Communication module, EtherCAT Communication module, Profibus DP V1 Communication module, PROFINET Communication module, Ethernet Powerlink Communication module, EtherNet/IP Communication module, DeviceNet
[Us] rated supply voltage	380...500 V - 15...10 %
Nominal output current	5.5 A
Motor power kW	2.2 kW for heavy duty
EMC filter	Class C2 EMC filter integrated
IP degree of protection	IP20

## Complementary

Discrete input number	7
Discrete input type	STO safe torque off, 24 V DC, impedance: 1.5 kOhm DI1...DI6 logic inputs, 24 V DC (30 V) DI5 programmable as pulse input: 0...30 kHz, 24 V DC (30 V)
Discrete input logic	Positive logic (source) Negative logic (sink)
Discrete output number	3
Discrete output type	Open collector DQ+ 0...1 kHz 30 V DC 100 mA Open collector DQ- 0...1 kHz 30 V DC 100 mA
Analogue input number	3
Analogue input type	AI1 voltage: 0...10 V DC, impedance: 30 kOhm, resolution 10 bits AI2 bipolar differential voltage: +/- 10 V DC, impedance: 30 kOhm, resolution 10 bits AI3 current: 0...20 mA (or 4-20 mA, x-20 mA, 20-x mA or other patterns by configuration), impedance: 250 Ohm, resolution 10 bits

<b>Analogue output number</b>	1
<b>Analogue output type</b>	Software-configurable current AQ1: 0...20 mA impedance 800 Ohm, resolution 10 bits Software-configurable voltage AQ1: 0...10 V DC impedance 470 Ohm, resolution 10 bits
<b>Relay output type</b>	Configurable relay logic R1A 1 NO electrical durability 100000 cycles Configurable relay logic R1B 1 NC electrical durability 100000 cycles Configurable relay logic R1C Configurable relay logic R2A 1 NO electrical durability 100000 cycles Configurable relay logic R2C
<b>Maximum switching current</b>	Relay output R1A, R1B, R1C on resistive load, cos phi = 1: 3 A at 250 V AC Relay output R1A, R1B, R1C on resistive load, cos phi = 1: 3 A at 30 V DC Relay output R1A, R1B, R1C, R2A, R2C on inductive load, cos phi = 0.4 and L/R = 7 ms: 2 A at 250 V AC Relay output R1A, R1B, R1C, R2A, R2C on inductive load, cos phi = 0.4 and L/R = 7 ms: 2 A at 30 V DC Relay output R2A, R2C on resistive load, cos phi = 1: 5 A at 250 V AC Relay output R2A, R2C on resistive load, cos phi = 1: 5 A at 30 V DC
<b>Minimum switching current</b>	Relay output R1A, R1B, R1C, R2A, R2C: 5 mA at 24 V DC
<b>Method of access</b>	Slave CANopen
<b>4 quadrant operation possible</b>	True
<b>Asynchronous motor control profile</b>	Voltage/frequency ratio, 5 points Flux vector control without sensor, standard Voltage/frequency ratio - Energy Saving, quadratic U/f Flux vector control without sensor - Energy Saving Voltage/frequency ratio, 2 points
<b>Synchronous motor control profile</b>	Vector control without sensor
<b>Maximum output frequency</b>	0.599 kHz
<b>Transient overtorque</b>	170...200 % of nominal motor torque
<b>Acceleration and deceleration ramps</b>	Linear U S CUS Ramp switching Acceleration/deceleration ramp adaptation Acceleration/deceleration automatic stop with DC injection
<b>Motor slip compensation</b>	Automatic whatever the load Adjustable 0...300 % Not available in voltage/frequency ratio (2 or 5 points)
<b>Switching frequency</b>	2...16 kHz adjustable 4...16 kHz with derating factor
<b>Nominal switching frequency</b>	4 kHz
<b>Braking to standstill</b>	By DC injection
<b>Brake chopper integrated</b>	True
<b>Line current</b>	8.7 A at 380 V (heavy duty) 6.6 A at 500 V (heavy duty)
<b>Maximum input current</b>	8.7 A
<b>Maximum output voltage</b>	500 V
<b>Apparent power</b>	5.7 kVA at 500 V (heavy duty)
<b>Network frequency</b>	50...60 Hz
<b>Relative symmetric network frequency tolerance</b>	5 %
<b>Prospective line I<sub>sc</sub></b>	5 kA
<b>Base load current at high overload</b>	8.0 A
<b>Power dissipation in W</b>	Fan: 74.0 W at 380 V, switching frequency 4 kHz
<b>With safety function Safely Limited Speed (SLS)</b>	True
<b>With safety function Safe brake management (SBC/SBT)</b>	False

With safety function Safe Operating Stop (SOS)	False
With safety function Safe Position (SP)	False
With safety function Safe programmable logic	False
With safety function Safe Speed Monitor (SSM)	False
With safety function Safe Stop 1 (SS1)	True
With sft fct Safe Stop 2 (SS2)	False
With safety function Safe torque off (STO)	True
With safety function Safely Limited Position (SLP)	False
With safety function Safe Direction (SDI)	False
Protection type	Input phase breaks: drive Overcurrent between output phases and earth: drive Overheating protection: drive Short-circuit between motor phases: drive Thermal protection: drive
Width	140 mm
Height	184.0 mm
Depth	158.0 mm
Net weight	2.1 kg

## Environment

Operating position	Vertical +/- 10 degree
Product certifications	CE ATEX NOM GOST EAC RCM KC
Marking	CE ATEX UL CSA EAC RCM
Standards	EN/IEC 61800-5-1
Electromagnetic compatibility	Electrostatic discharge immunity test level 3 conforming to IEC 61000-4-2 Radiated radio-frequency electromagnetic field immunity test level 3 conforming to IEC 61000-4-3 Electrical fast transient/burst immunity test level 4 conforming to IEC 61000-4-4 1.2/50 $\mu$ s - 8/20 $\mu$ s surge immunity test level 3 conforming to IEC 61000-4-5 Conducted radio-frequency immunity test level 3 conforming to IEC 61000-4-6 Voltage dips and interruptions immunity test conforming to IEC 61000-4-11
Environmental class (during operation)	Class 3C3 according to IEC 60721-3-3 Class 3S2 according to IEC 60721-3-3
Maximum acceleration under shock impact (during operation)	150 m/s <sup>2</sup> at 11 ms
Maximum acceleration under vibrational stress (during operation)	10 m/s <sup>2</sup> at 13...200 Hz
Maximum deflection under vibratory load (during operation)	1.5 mm at 2...13 Hz
Permitted relative humidity (during operation)	Class 3K5 according to EN 60721-3

Volume of cooling air	37.7 m3/h
Overvoltage category	III
Regulation loop	Adjustable PID regulator
Speed accuracy	+/- 10 % of nominal slip 0.2 Tn to Tn
Pollution degree	2
Ambient air transport temperature	-25...70 °C
Ambient air temperature for operation	-10...50 °C without derating 50...60 °C with derating factor
Ambient air temperature for storage	-25...70 °C

## Packing Units

Unit Type of Package 1	PCE
Number of Units in Package 1	1
Package 1 Weight	2.652 kg
Package 1 Height	24.5 cm
Package 1 width	19.5 cm
Package 1 Length	26.7 cm
Unit Type of Package 2	P06
Number of Units in Package 2	12
Package 2 Weight	45.28 kg
Package 2 Height	73.5 cm
Package 2 width	60 cm
Package 2 Length	80 cm

## Offer Sustainability

Sustainable offer status	Green Premium product
REACH Regulation	<a href="#">REACH Declaration</a>
EU RoHS Directive	Pro-active compliance (Product out of EU RoHS legal scope) <a href="#">EU RoHS Declaration</a>
Mercury free	Yes
RoHS exemption information	<a href="#">Yes</a>
China RoHS Regulation	<a href="#">China RoHS declaration</a>
Environmental Disclosure	<a href="#">Product Environmental Profile</a>
Circularity Profile	<a href="#">End of Life Information</a>
WEEE	The product must be disposed on European Union markets following specific waste collection and never end up in rubbish bins
Upgradeability	Upgraded components available

## Contractual warranty

Warranty	18 months
----------	-----------

Dimensions

Right View, Front View and Front View with EMC Plate

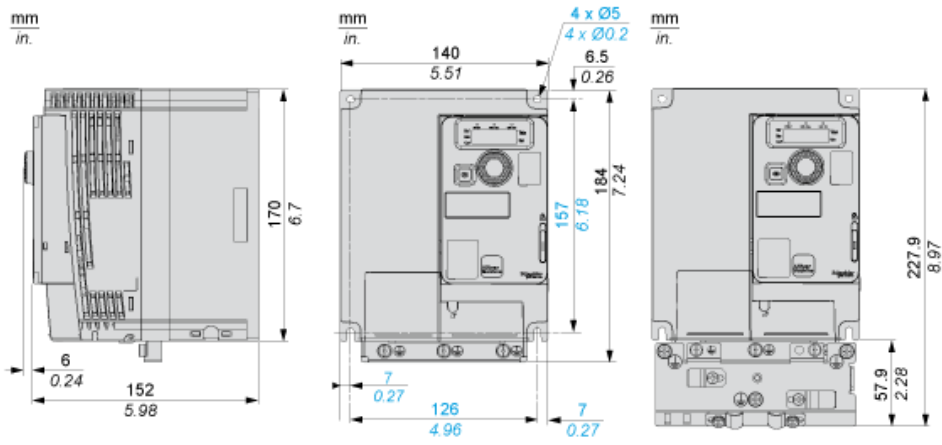

**Mounting Types**

---

**Mounting Type A: Individual with Ventilation Cover**

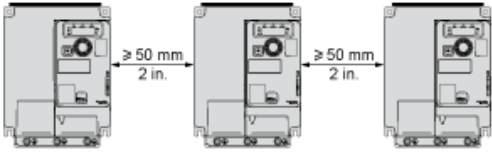

Only Possible at Ambient Temperature Less or Equal to 50 °C (122 °F)

**Mounting Type B: Side by Side, Ventilation Cover Removed**

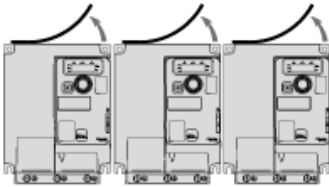

**Mounting Type C: Individual, Ventilation Cover Removed**

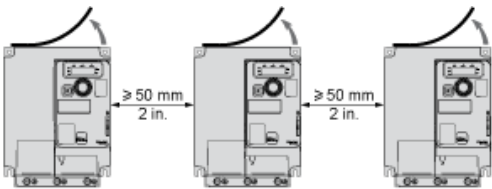

For Operation at Ambient Temperature Above 50 °C (122 °F)

**Connection Diagrams**

**Diagram with Line Contactor**

Connection diagrams conforming to standards ISO13849 category 1 and IEC/EN 61508 capacity SIL1, stopping category 0 in accordance with standard IEC/EN 60204-1.



- (1) Line choke (if used)
- (2) Fault relay contacts, for remote signaling of drive status

**Diagram with Switch Disconnect**

Connection diagrams conforming to standards EN 954-1 category 1 and IEC/EN 61508 capacity SIL1, stopping category 0 in accordance with standard IEC/EN 60204-1.



- (1) Line choke (if used)
- (2) Fault relay contacts, for remote signaling of drive status

**Control Connection Diagram in Source Mode**



- (1) Analog output
- (2) Analog inputs
- (3) Reference potentiometer (10 kOhm maxi)
- (4) Digital inputs



**Digital Inputs Wiring**

The logic input switch (SW1) is used to adapt the operation of the logic inputs to the technology of the programmable controller outputs. Switch SW1 set to "Source" position and use of the output power supply for the DIs.



Switch SW1 set to "Source" position and use of an external power supply for the DIs.

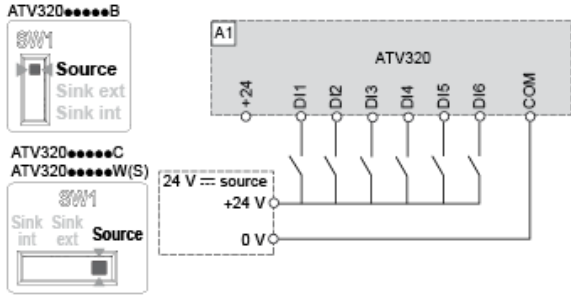

Switch SW1 set to "Sink Int" position and use of the output power supply for the DIs.

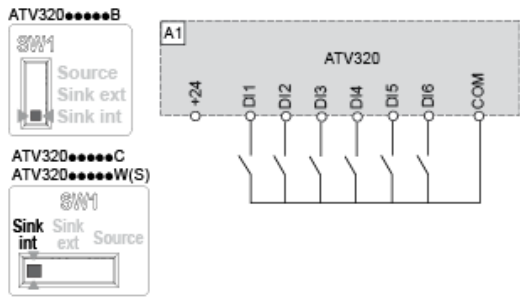

Switch SW1 set to "Sink Ext" position and use of an external power supply for the DIs.

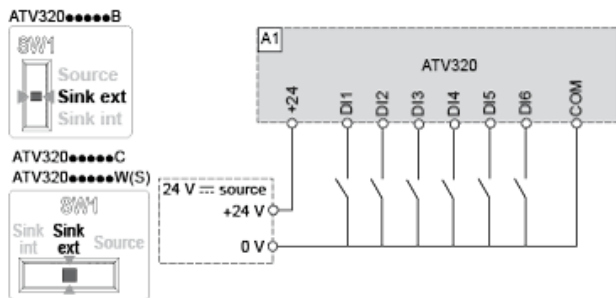

Derating Curves

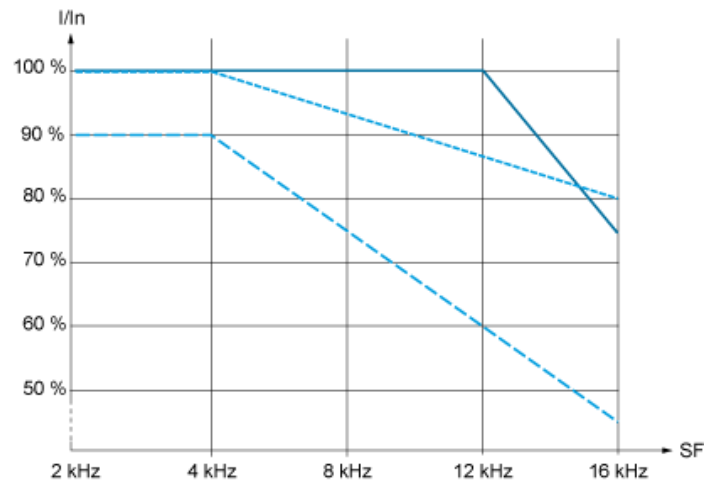

- 40 °C (104 °F) - Mounting type A, B and C
  - - - 50 °C (122 °F) - Mounting type C
  - . - 60 °C (140 °F) - Mounting type C
- In :** Nominal Drive Current  
**SF :** Switching Frequency