



EMERG. STOP SWITCH 6-POLE IU=32,  
P/AC-23A AT 400V=11.5KW FRONT MOUNTING FOUR-  
HOLE MOUNTING ROTARY ACTUATOR RED/YELLOW  
(EMERG. STOP)

Similar to image

**General technical details:**

<b>product brand name</b>		SETRON
<b>product designation</b>		main and EMERGENCY-OFF switches
<b>Type from device</b>		fixed mounting
<b>Design of the operating mechanism</b>		rotary actuator, red/yellow
<b>Protection class IP</b>		IP65
<b>Number of poles</b>		6
<b>Acceptability for application</b>		
• switch disconnecter		Yes
• main switch		Yes
• safety cut-out switch		Yes
• emergency stop switch		Yes
• maintenance/repair switch		Yes
<b>Product equipment / interlock</b>		Yes
<b>Type of the driving mechanism / motor drive</b>		No
<b>Product extension / optional</b>		
• motor drive		No
• voltage trigger		No
<b>Ambient temperature / during operating</b>	°C	-25 ... +55

Insulation voltage / rated value	V	690
Impulse voltage resistance / rated value	V	6,000
Active power loss / per conductor / typical	W	1.8
Mechanical operating cycles as operating time / of the main contacts / typical		100,000
Protection against electrical shock		finger-safe
Item designation / according to DIN EN 61346-2		S
Item designation / according to DIN 40719 extendable after IEC 204-2 / according to IEC 750		S

#### Main circuit:

Continuous current / rated value	A	32
Operating current / at AC-21 / rated value	A	32
Short-time current resistance (I <sub>cw</sub> ) / at 690 V / limited to 1 s / rated value	A	640
Operating frequency	Hz	50 ... 60
Operating voltage / at 50/60 Hz / for AC / rated value	V	690
Service power / at AC-3		
• at 400 V / rated value	kW	9.5
• at 690 V / rated value	kW	9.5
Service power / at AC-23 A		
• at 400 V / rated value	kW	11.5
• at 690 V / rated value	kW	11.5
Operating cycles / maximum	1/h	50

#### Auxiliary circuit:

Number of NC contacts / for auxiliary contacts		0
Number of NO contacts / for auxiliary contacts		0
Number of changeover contacts / for auxiliary contacts		0
Continuous current / of the auxiliary contact / rated value	A	10
Operating voltage / of the auxiliary contacts / for AC / maximum	V	500
Insulation voltage / of the auxiliary switch / rated value	V	500

#### Short-circuit:

Design of the fuse link / for short-circuit protection of the main circuit / necessary		fuse gL/gG: 40 A
Design of the fuse link / for short-circuit protection of the auxiliary switch / required		fuse gL/gG: 10 A

#### Installation/mounting/dimensions:

Type of mounting		front mounting
• front mounting		Yes
• front mounting with central fixation		No

• front mounting with 4-hole fixation		Yes
• series installation		Yes
• Rail installation		No
<b>Width</b>	mm	67
<b>Height</b>	mm	83
<b>Depth</b>	mm	92.5







#### Connection type:

<b>Design of the electrical connection / for main current circuit</b>		connection terminals
<b>Design of the electrical connection / for auxiliary contact</b>		connection terminals
<b>Type of connectable conductor cross section / for auxiliary contacts</b>		
• finely stranded / with conductor end processing		2x (0.75 ... 1.5 mm <sup>2</sup> ), 1x 2.5 mm <sup>2</sup>

#### Certificates/approvals:

<b>Verification of suitability</b>		CSA / UL / CCC / GL / LRS / DNV / PRS
<b>Conductor cross section that can be connected / for main contacts / solid / minimum</b>	mm <sup>2</sup>	1.5
<b>Conductor cross section that can be connected / for main contacts / solid / maximum</b>	mm <sup>2</sup>	16
<b>Conductor cross section that can be connected / for main contacts / stranded / minimum</b>	mm <sup>2</sup>	1.5
<b>Conductor cross section that can be connected / for main contacts / stranded / maximum</b>	mm <sup>2</sup>	16
<b>Conductor cross section that can be connected / for main contacts / stranded wire / with conductor end processing / maximum</b>	mm <sup>2</sup>	10
<b>Conductor cross-section that can be connected / for auxiliary contact / solid / minimum</b>	mm <sup>2</sup>	0.75
<b>Conductor cross-section that can be connected / for auxiliary contact / solid / maximum</b>	mm <sup>2</sup>	4
<b>Conductor cross-section that can be connected / for auxiliary contact / finely stranded / with conductor end processing / minimum</b>	mm <sup>2</sup>	0.75
<b>Conductor cross-section that can be connected / for auxiliary contact / finely stranded / with conductor end processing / maximum</b>	mm <sup>2</sup>	2.5
<b>Conductor cross section that can be connected / for auxiliary contacts / stranded / min.</b>	mm <sup>2</sup>	0.75
<b>Conductor cross section that can be connected / for auxiliary contacts / stranded / max.</b>	mm <sup>2</sup>	4

#### Certificates/approvals:

<b>General Product Approval</b>			<b>Test Certificates</b>	
 CSA	 GOST	 UL	<a href="#">Special Test Certificate</a>	
<b>Shipping Approval</b>			<b>other</b>	
 GL	 LRS	 PRS	<a href="#">Declaration of Conformity</a>	<a href="#">Environmental Confirmations</a>

**Further information:**

- Information- and Downloadcenter (Catalogs, Brochures,...)**  
<http://www.siemens.com/lowvoltage/catalogs>

---

- Industry Mall (Online ordering system)**  
<http://www.siemens.com/lowvoltage/mall>

---

- Service&Support (Manuals, Certificates, Characteristics, FAQs,...)**  
<http://support.automation.siemens.com/WW/view/en/3LD2203-3VK53/all>

---

- Image database (product images, 2D dimension drawings, 3D models, device circuit diagrams, ...)**  
[http://www.automation.siemens.com/bilddb/cax\\_en.aspx?mlfb=3LD2203-3VK53](http://www.automation.siemens.com/bilddb/cax_en.aspx?mlfb=3LD2203-3VK53)

---

- CAX-Online-Generator**  
<http://www.siemens.com/cax>

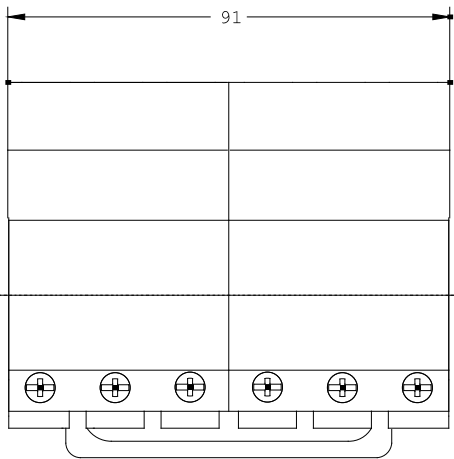
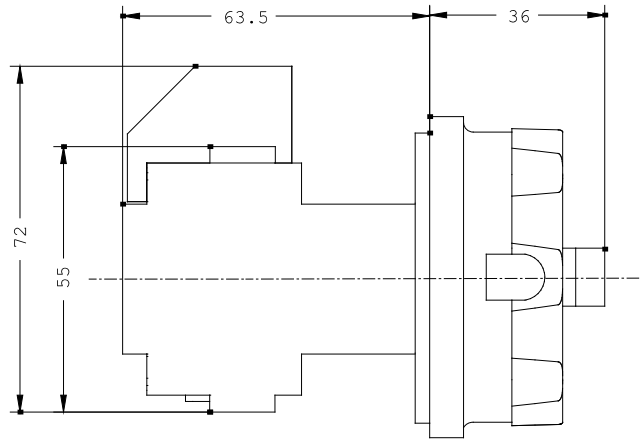
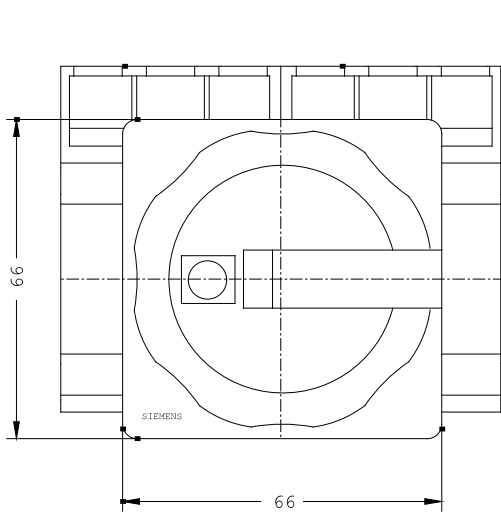

Bohrbild  
Tuer

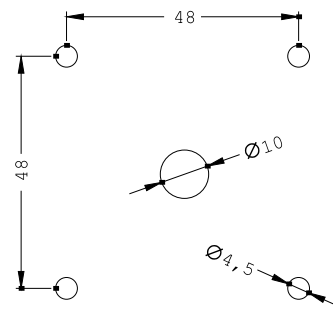

last change:

Oct 28, 2013