

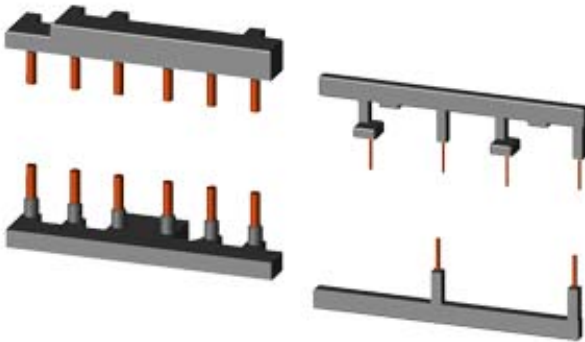











WIRING KIT,
SCREW ELECTRICAL AND MECHANICAL,
INCL. MECH. INTERLOCK,
FOR REVERSING STARTERS, SIZE S0



| General technical data: | | |
|-------------------------------|--|--|
| product brand name | | SIRIUS |
| product designation | | wiring module reversing contactors S0, screw terminals |
| Size of the circuit-breaker | | S0 |
| Size of the contactor | | S0 |
| Design of the product | | actuating voltage contactor: AC and DC |
| Acceptability for application | | Reversing starter kit |

| Installation/mounting/dimensions: | | |
|-----------------------------------|----|--------------|
| Type of mounting | | screw fixing |
| Height | mm | 10 |

Certificates/approvals:

| General Product Approval | | | Declaration of Conformity | Test Certificates | |
|---|--|--|---|--|--|
|  CSA |  GOST |  UR |  EG-Konf. | Special Test Certificate | |
| Shipping Approval | | | | | |
|  ABS |  BUREAU VERITAS |  DNV |  GL |  LRS |  PRS |
| Shipping Approval | | other | | | |
|  RINA |  RMRS | other | | | |

Further information:

Information- and Downloadcenter (Catalogs, Brochures,...)

<http://www.siemens.com/industrial-controls/catalogs>

Industry Mall (Online ordering system)

<http://www.siemens.com/industrial-controls/mall>

CAX-Online-Generator

<http://www.siemens.com/cax>

Service&Support (Manuals, Certificates, Characteristics, FAQs,...)

<http://support.automation.siemens.com/WW/view/en/3RA2923-2AA1/all>

Image database (product images, 2D dimension drawings, 3D models, device circuit diagrams, ...)

http://www.automation.siemens.com/bilddb/cax_en.aspx?mlfb=3RA2923-2AA1

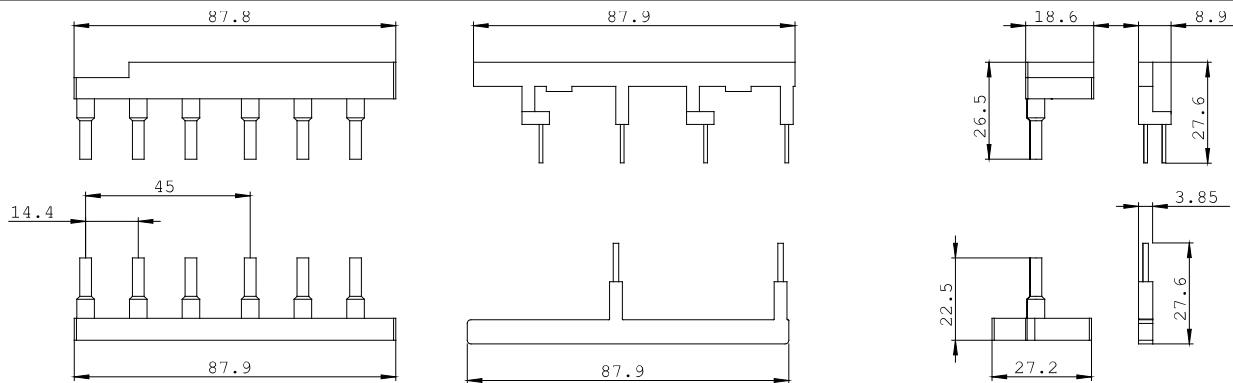

last change:

Dec 17, 2012