

CONTACTOR, AC-3 15 KW/400 V, DC 24 V, 3-POLE, SIZE S2,
SCREW CONNECTION



Figure similar

product brand name	SIRIUS
Product designation	power contactor
General technical data:	
Size of contactor	S2
Insulation voltage	
• rated value	690 V
Degree of pollution	3
Surge voltage resistance rated value	6 kV
maximum permissible voltage for safe isolation	
• between coil and main contacts acc. to EN 60947-1	400 V
Protection class IP	
• on the front	IP00
• of the terminal	IP00
Shock resistance	
• at rectangular impulse	
— at DC	10g / 5 ms, 5g / 10 ms

<ul style="list-style-type: none"> • with sine pulse <ul style="list-style-type: none"> — at DC 	15g / 5 ms, 8g / 10 ms
Mechanical service life (switching cycles)	
<ul style="list-style-type: none"> • of contactor typical 	10 000 000
<ul style="list-style-type: none"> • of the contactor with added electronics-compatible auxiliary switch block typical 	5 000 000
<ul style="list-style-type: none"> • of the contactor with added auxiliary switch block typical 	10 000 000
Ambient conditions:	
Installation altitude at height above sea level maximum	2 000 m
Ambient temperature	
<ul style="list-style-type: none"> • during operation 	-25 ... +60 °C
<ul style="list-style-type: none"> • during storage 	-55 ... +80 °C
Main circuit:	
Number of NO contacts for main contacts	3
Number of NC contacts for main contacts	0
Operating current	
<ul style="list-style-type: none"> • at AC-1 at 400 V <ul style="list-style-type: none"> — at ambient temperature 40 °C rated value 	50 A
<ul style="list-style-type: none"> • at AC-1 up to 690 V <ul style="list-style-type: none"> — at ambient temperature 40 °C rated value — at ambient temperature 60 °C rated value 	50 A 45 A
<ul style="list-style-type: none"> • at AC-3 <ul style="list-style-type: none"> — at 400 V rated value — at 690 V rated value 	32 A 20 A
Connectable conductor cross-section in main circuit at AC-1	
<ul style="list-style-type: none"> • at 60 °C minimum permissible 	10 mm ²
<ul style="list-style-type: none"> • at 40 °C minimum permissible 	16 mm ²
Operating current for approx. 200000 operating cycles at AC-4	
<ul style="list-style-type: none"> • at 400 V rated value 	15.6 A
<ul style="list-style-type: none"> • at 690 V rated value 	11 A
Operating current	
<ul style="list-style-type: none"> • at 1 current path at DC-1 <ul style="list-style-type: none"> — at 24 V rated value — at 110 V rated value 	45 A 4.5 A
<ul style="list-style-type: none"> • with 2 current paths in series at DC-1 <ul style="list-style-type: none"> — at 24 V rated value — at 110 V rated value 	45 A 25 A
<ul style="list-style-type: none"> • with 3 current paths in series at DC-1 	

— at 24 V rated value	45 A
— at 110 V rated value	45 A
Operating current	
• at 1 current path at DC-3 at DC-5	
— at 24 V rated value	35 A
— at 110 V rated value	2.5 A
• with 2 current paths in series at DC-3 at DC-5	
— at 110 V rated value	25 A
— at 24 V rated value	45 A
• with 3 current paths in series at DC-3 at DC-5	
— at 110 V rated value	45 A
— at 24 V rated value	45 A
Operating power	
• at AC-1	
— at 230 V at 60 °C rated value	18 kW
— at 400 V rated value	31 kW
— at 690 V rated value	54 kW
— at 690 V at 60 °C rated value	54 kW
• at AC-2 at 400 V rated value	15 kW
• at AC-3	
— at 230 V rated value	7.5 kW
— at 400 V rated value	15 kW
— at 500 V rated value	18.5 kW
— at 690 V rated value	18.5 kW
Operating power for approx. 200000 operating cycles at AC-4	
• at 400 V rated value	8.2 kW
• at 690 V rated value	10 kW
Thermal short-time current limited to 10 s	320 A
Power loss [W] at AC-3 at 400 V for rated value of the operating current per conductor	1.8 W
No-load switching frequency	
• at DC	1 500 1/h
Operating frequency	
• at AC-1 maximum	1 200 1/h
• at AC-2 maximum	750 1/h
• at AC-3 maximum	1 000 1/h
• at AC-4 maximum	250 1/h
Control circuit/ Control:	
Type of voltage of the control supply voltage	DC
Control supply voltage at DC	
• rated value	24 V

Operating range factor control supply voltage rated value of magnet coil at DC	0.8 ... 1.1
Closing power of magnet coil at DC	13.3 W
Holding power of magnet coil at DC	13.3 W
Closing delay <ul style="list-style-type: none"> • at DC 	50 ... 95 ms
Opening delay <ul style="list-style-type: none"> • at DC 	20 ... 30 ms
Arcing time	10 ... 15 ms

Auxiliary circuit:

Number of NC contacts <ul style="list-style-type: none"> • for auxiliary contacts <ul style="list-style-type: none"> — instantaneous contact 	0
Number of NO contacts <ul style="list-style-type: none"> • for auxiliary contacts <ul style="list-style-type: none"> — instantaneous contact 	0
Operating current at AC-12 maximum	10 A
Operating current at AC-15 <ul style="list-style-type: none"> • at 230 V rated value • at 400 V rated value 	6 A 3 A
Operating current at DC-12 <ul style="list-style-type: none"> • at 60 V rated value • at 110 V rated value • at 220 V rated value 	6 A 3 A 1 A
Operating current at DC-13 <ul style="list-style-type: none"> • at 24 V rated value • at 60 V rated value • at 110 V rated value • at 220 V rated value 	10 A 2 A 1 A 0.3 A
Contact reliability of auxiliary contacts	1 faulty switching per 100 million (17 V, 1 mA)

UL/CSA ratings:

Contact rating of auxiliary contacts according to UL	A600 / Q600
---	-------------

Short-circuit protection

Design of the fuse link <ul style="list-style-type: none"> • for short-circuit protection of the main circuit <ul style="list-style-type: none"> — with type of coordination 1 required — with type of assignment 2 required • for short-circuit protection of the auxiliary switch required 	fuse gL/gG: 125 A fuse gL/gG: 63 A fuse gL/gG: 10 A
--	---

Installation/ mounting/ dimensions:





Mounting type	screw and snap-on mounting onto 35 mm standard mounting rail according to DIN EN 50022
<ul style="list-style-type: none"> • Side-by-side mounting 	Yes
Height	112 mm
Width	55 mm
Depth	130 mm
Required spacing	
<ul style="list-style-type: none"> • for grounded parts <ul style="list-style-type: none"> — at the side 	6 mm



Connections/ Terminals:

Type of electrical connection	
<ul style="list-style-type: none"> • for main current circuit • for auxiliary and control current circuit 	screw-type terminals screw-type terminals
Type of connectable conductor cross-sections	
<ul style="list-style-type: none"> • for main contacts <ul style="list-style-type: none"> — solid — stranded — single or multi-stranded — finely stranded with core end processing — finely stranded without core end processing • at AWG conductors for main contacts 	2x (0.75 ... 16 mm ²) 2x (0.75 ... 25 mm ²) 2x (0,75 ... 16 mm ²) 2x (0.75 ... 16 mm ²) 2x (0.75 ... 16 mm ²) 2x (18 ... 2)
Type of connectable conductor cross-sections	
<ul style="list-style-type: none"> • for auxiliary contacts <ul style="list-style-type: none"> — solid — finely stranded with core end processing • at AWG conductors for auxiliary contacts 	2x (0.5 ... 1.5 mm ²), 2x (0.75 ... 2.5 mm ²), max. 2x (0.75 ... 4 mm ²) 2x (0.5 ... 1.5 mm ²), 2x (0.75 ... 2.5 mm ²) 2x (20 ... 16), 2x (18 ... 14), 1x 12

Certificates/approvals

General Product Approval				Declaration of Conformity	Test Certificates
 CCC	 CSA		 UL	 EG-Konf.	spezielle Prüfbescheinigungen

Test Certificates		Shipping Approval			
Typprüfbescheinigung/Werkszeugnis	sonstig	 ABS	 DNV	 GL	 LRS

Shipping Approval		other		
 RINA	 RMRS	Bestätigungen	Umweltbestätigung	sonstig

Further information

Information- and Downloadcenter (Catalogs, Brochures,...)

<http://www.siemens.com/industrial-controls/catalogs>

Industry Mall (Online ordering system)

<https://mall.industry.siemens.com/mall/en/en/Catalog/product?mlfb=3RT1034-1BB40>

Cax online generator

<http://support.automation.siemens.com/WW/CAXorder/default.aspx?lang=en&mlfb=3RT1034-1BB40>

Service&Support (Manuals, Certificates, Characteristics, FAQs,...)

<https://support.industry.siemens.com/cs/ww/en/ps/3RT1034-1BB40>

Image database (product images, 2D dimension drawings, 3D models, device circuit diagrams, EPLAN macros, ...)

http://www.automation.siemens.com/bilddb/cax_de.aspx?mlfb=3RT1034-1BB40&lang=en

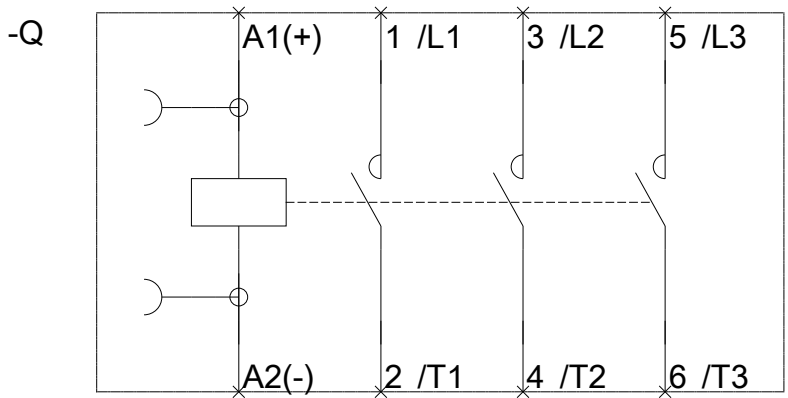
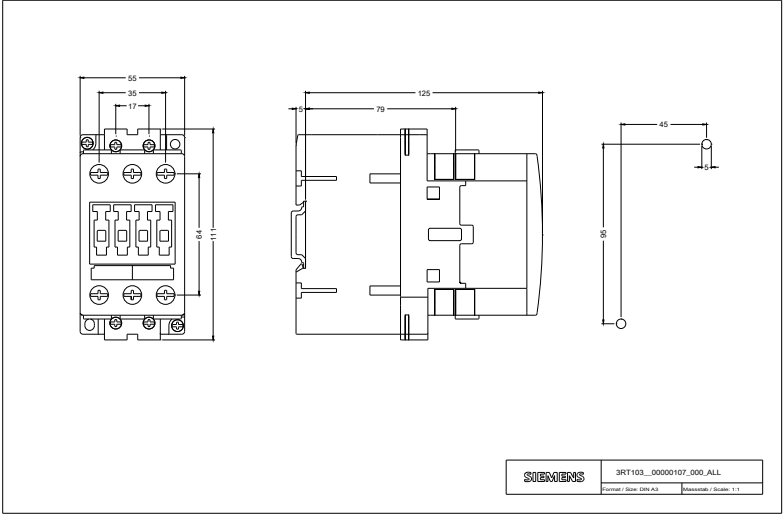

last modified:

07/21/2016