

22MM PLASTIC ROUND ACTUATOR: SELECTOR SWITCH  
LATCHING 2 SWITCH POSITIONS O-I ILLUMINATED INCL.  
HOLDER FOR 3 ELEMENTS WITH HOLDER YELLOW

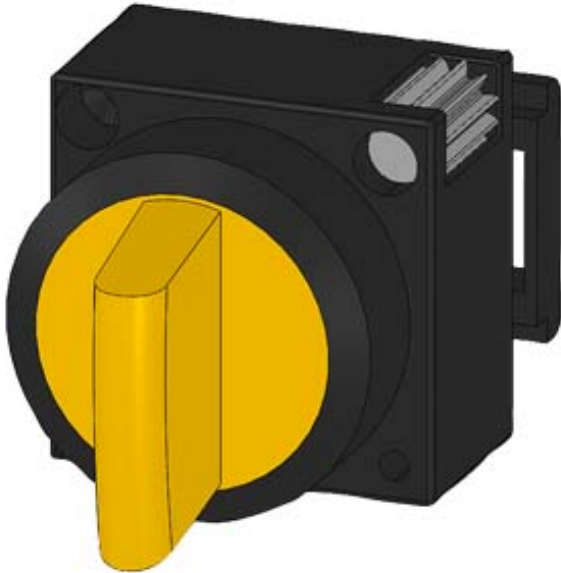

Design of the product	Single device round
<b>Enclosure</b>	
Number of command points	1
<b>Actuator</b>	
Design of the operating mechanism	selector switch
Manner of function of the actuating element	Latching
Product extension optional Light source	Yes
Color	
• of the actuating element	Yellow
Material of the actuating element	plastic
Outer diameter of the actuating element	28.5 mm
Type of unlocking device	rotate-to-unlatch mechanism
Number of switching positions	2
Actuating angle	
• clockwise	50°
<b>Front ring</b>	
Product component front ring	Yes
Design of the front ring	Standard

Material of the front ring	plastic
Color of the front ring	black

### Holder

Material of the holder	Plastic
------------------------	---------

### General technical data

<b>Product function</b>	
• EMERGENCY OFF function	No
• EMERGENCY STOP function	No
<b>Protection class IP</b>	IP66
<b>Vibration resistance</b>	
• acc. to IEC 60068-2-6	20 ... 200 Hz: 5g
<b>Operating frequency maximum</b>	1 000 1/h
<b>Mechanical service life (switching cycles)</b>	
• typical	300 000
<b>Equipment marking</b>	
• acc. to DIN 40719 extended according to IEC 204-2 acc. to IEC 750	S
• acc. to DIN EN 61346-2	S
• acc. to DIN EN 81346-2	S

### Connections/Terminals

Tightening torque of the screws in the bracket	1 ... 1.2 N·m
--	---------------



### Ambient conditions



<b>Ambient temperature</b>	
• during operation	-25 ... +70 °C
• during storage	-40 ... +80 °C
<b>Environmental category during operation acc. to IEC 60721</b>	3K6

### Installation/ mounting/ dimensions

<b>Mounting type</b>	front mounting
<b>Shape of the installation opening</b>	round
<b>Mounting diameter</b>	22 mm
<b>Mounting height</b>	24 mm
<b>Installation width</b>	28.5 mm
<b>Installation depth</b>	29 mm

### Certificates/approvals

General Product Approval			Declaration of Conformity	Test Certificates	Shipping Approval
 CSA	 UL		 EG-Konf.	<a href="#">spezielle Prüfbescheinigung</a> <u>n</u>	 ABS

Shipping Approval			other		
 LRS	 PRS	 RINA	<a href="#">sonstig</a>	<a href="#">Bestätigungen</a>	<a href="#">Umweltbestätigung</a>

#### Further information

##### Information- and Downloadcenter (Catalogs, Brochures,...)

<http://www.siemens.com/industrial-controls/catalogs>

##### Industry Mall (Online ordering system)

<https://mall.industry.siemens.com/mall/en/en/Catalog/product?mlfb=3SB3001-2KA31>

##### Cax online generator

<http://support.automation.siemens.com/WW/CAXorder/default.aspx?lang=en&mlfb=3SB3001-2KA31>

##### Service&Support (Manuals, Certificates, Characteristics, FAQs,...)

<https://support.industry.siemens.com/cs/ww/en/ps/3SB3001-2KA31>

##### Image database (product images, 2D dimension drawings, 3D models, device circuit diagrams, EPLAN macros, ...)

[http://www.automation.siemens.com/bilddb/cax\\_de.aspx?mlfb=3SB3001-2KA31&lang=en](http://www.automation.siemens.com/bilddb/cax_de.aspx?mlfb=3SB3001-2KA31&lang=en)

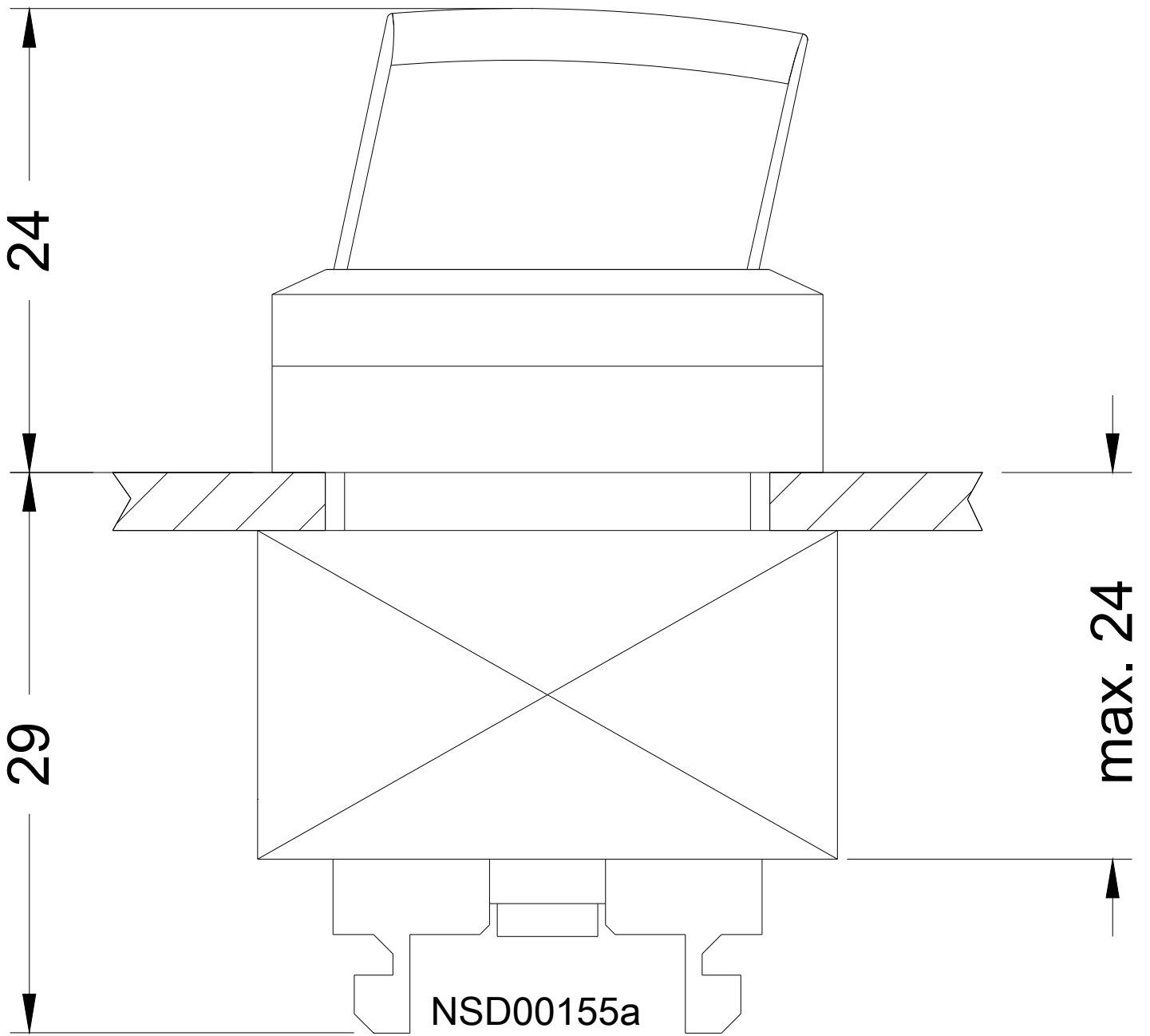

last modified:

02/23/2017