



ENCLOSURE FOR 22MM PROGRAM PLASTIC VERSION
2 COMMAND POSITIONS GRAY TOP PART

Enclosure:		
Design of the enclosure		Empty enclosure for command and signaling devices
Material / of the enclosure		plastic
Color / of top part of the enclosure		grey
Number of Command Points		2
Product component / protective collar		No
Form / of the enclosure front		rectangular
Design of electrical connection / on enclosure		Cable routing above, below / left, right, each 1 x M20
Type of mounting / of enclosure		Vertical / horizontal
Product function / EMERGENCY STOP function		No

Actuato/ signaling device:		
Product component / front ring		No

Contact block/ lampholder:		
Product function / positive opening		No
Type of fixing/fixation / for contact blocks		Floor mounting / front mounting (1-pole)
Product component / fluorescent materials		No
Product extension / optional / fluorescent materials		Yes









Accessories:		
--------------	--	--

Number of labeling plates		2
Product component / holder for 3 switching elements		No

General technical details:

Delivery state / pre-wired on strip terminal		No
Product component / stand/pedestal		No
Resistance against shock <ul style="list-style-type: none"> for devices with incandescent lamp / according to IEC 60068-2-27 for devices without incandescent lamp / according to IEC 60068-2-27 		<= 30g <= 50g
Resistance against vibration / according to IEC 60068-2-6		20 ... 200 Hz: 5g
Item designation <ul style="list-style-type: none"> according to DIN EN 61346-2 according to DIN 40719 extendable after IEC 204-2 / according to IEC 750 		U S
Ambient temperature <ul style="list-style-type: none"> during operating during storage 	°C °C	-25 ... +70 -40 ... +80
Protection class IP		IP65
climatic class / during the operating phase / according to EN 60721		3K6
Shape / of the installation hole		round
Mounting diameter	mm	22
Width	mm	85
Height	mm	114
Depth	mm	64

Certificates/ approvals:

General Product Approval	Declaration of Conformity	Test Certificates
 CSA  EAC  UL	 EG-Konf.	Special Test Certificate
Shipping Approval	other	
 ABS  DNV  LRS  PRS	Confirmation Environmental Confirmations	

Further information:

Information- and Downloadcenter (Catalogs, Brochures,...)
<http://www.siemens.com/industrial-controls/catalogs>

Industry Mall (Online ordering system)

<http://www.siemens.com/industrial-controls/mall>

Cax online generator

<http://www.siemens.com/cax>

Service&Support (Manuals, Certificates, Characteristics, FAQs,...)

<http://support.automation.siemens.com/WW/view/en/3SB3802-0AA3/all>

Image database (product images, 2D dimension drawings, 3D models, device circuit diagrams, ...)

http://www.automation.siemens.com/bilddb/cax_en.aspx?mlfb=3SB3802-0AA3

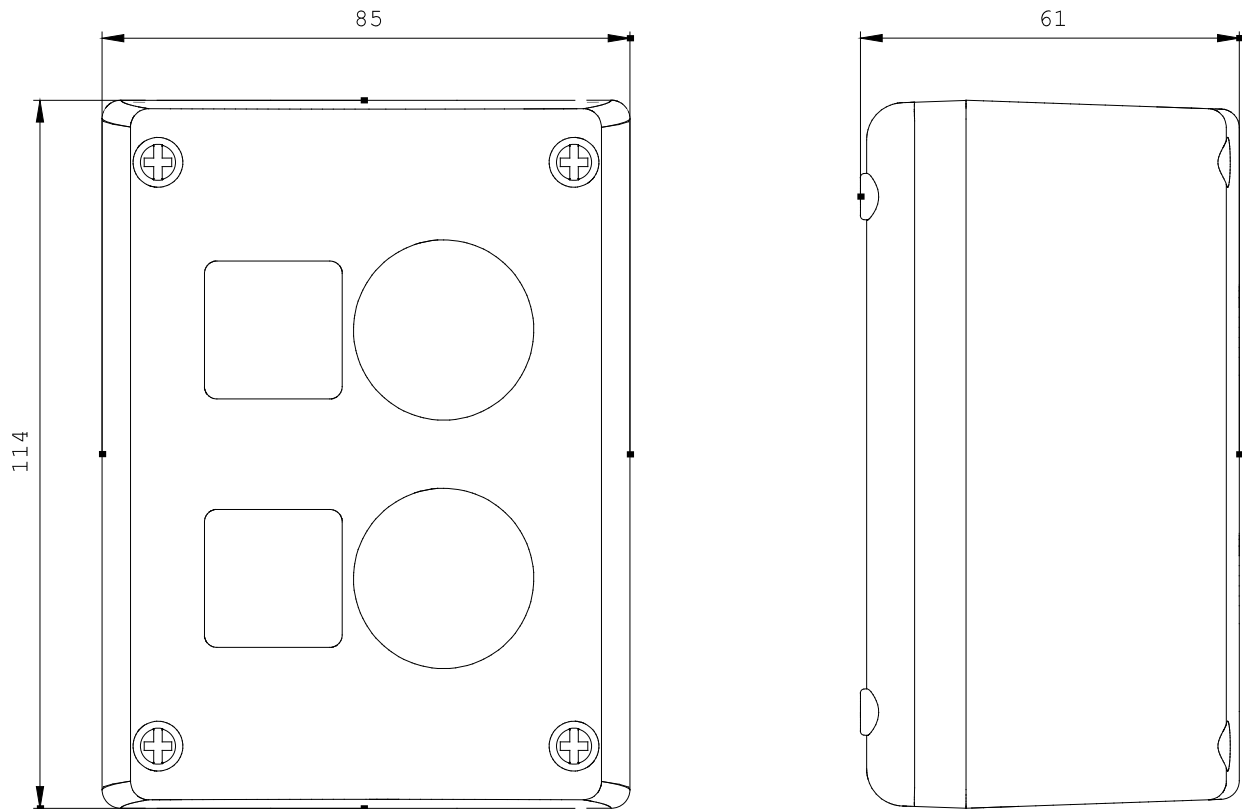

\w9.4444;

3S

last change:

Oct 28, 2013