



Indicator lights, 22 mm, round, metal, shiny, green, lens, smooth





product brand name	SIRIUS ACT
product designation	Indicator lights
design of the product	Actuating/signaling element
product type designation	3SU1
product line	Metal, shiny, 22 mm
Actuator	
product extension optional	
• light source	Yes
• contact module	No
color	
• of the actuating element	green
material of the actuating element	plastic
shape of the actuating element	round
outer diameter of the actuating element	29.45 mm
Front ring	
product component front ring	No
General technical data	
protection class IP	IP66, IP67, IP69(IP69K)
degree of protection NEMA rating	1, 2, 3, 3R, 4, 4X, 12, 13
shock resistance	
• acc. to IEC 60068-2-27	Sinusoidal half-wave 50g / 11 ms
vibration resistance	
• acc. to IEC 60068-2-6	10 ... 500 Hz: 5g
reference code acc. to IEC 81346-2	P
Substance Prohibitance (Date)	01.10.2014 00:00:00
Connections/ Terminals	
tightening torque of the screws in the bracket	1 ... 1.2 N·m
Ambient conditions	
ambient temperature	
• during operation	-25 ... +70 °C
• during storage	-40 ... +80 °C
environmental category during operation acc. to IEC 60721	3M6, 3S2, 3B2, 3C3, 3K6 (with relative air humidity of 10 ... 95 %)
Installation/ mounting/ dimensions	
height	29.5 mm
width	29.5 mm
shape of the installation opening	round

mounting diameter	22.3 mm
positive tolerance of installation diameter	0.4 mm
mounting height	11.8 mm
installation width	29.5 mm
installation depth	24.4 mm

Certificates/ approvals

General Product Approval	Declaration of Conformity	Test Certificates
  	Miscellaneous	 EG-Konf. Type Test Certificates/Test Report

Marine / Shipping

Marine / Shipping	other
    	Confirmation

Further information

- Information- and Downloadcenter (Catalogs, Brochures,...)

<https://www.siemens.com/ic10>
- Industry Mall (Online ordering system)

<https://mall.industry.siemens.com/mall/en/en/Catalog/product?mfb=3SU1051-6AA40-0AA0>
- Cax online generator

<http://support.automation.siemens.com/WW/CAXorder/default.aspx?lang=en&mfb=3SU1051-6AA40-0AA0>
- Service&Support (Manuals, Certificates, Characteristics, FAQs,...)

<https://support.industry.siemens.com/cs/ww/en/ps/3SU1051-6AA40-0AA0>
- Image database (product images, 2D dimension drawings, 3D models, device circuit diagrams, EPLAN macros, ...)

http://www.automation.siemens.com/bilddb/cax_de.aspx?mfb=3SU1051-6AA40-0AA0&lang=en

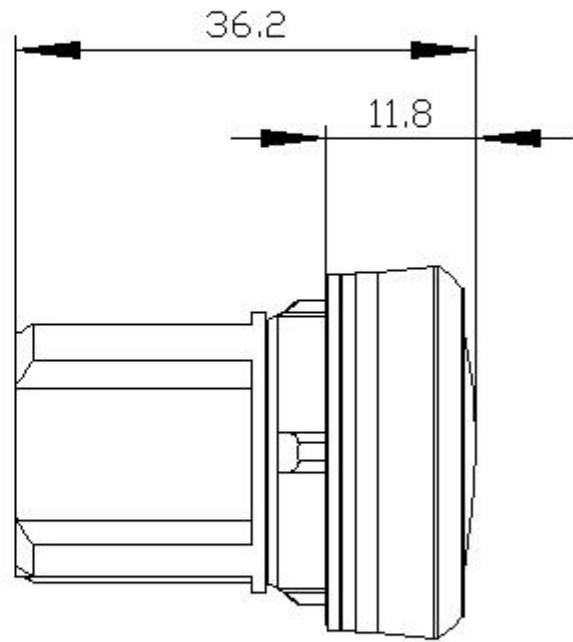
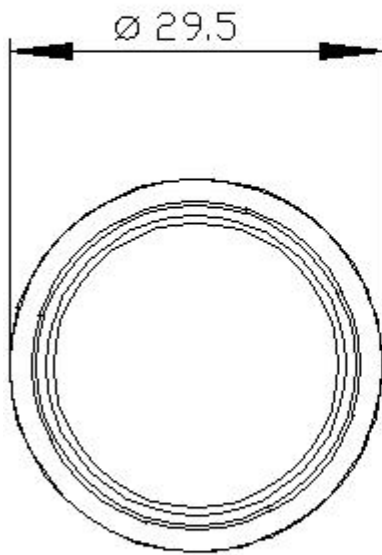

last modified:

12/21/2020 