

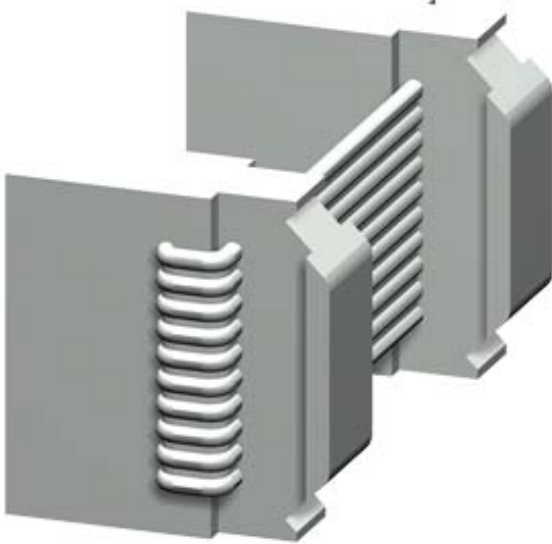



CONNECTION CABLE; LENGTH 0,1M; FLAT; CONNECTION OF BASIC UNIT TO CURRENT MEASURING MODULE, CURRENT/VOLTAGE MEASUR. MODULE, OPERATOR PANEL OR TO EXPANSION MODULES VIA SYSTEM INTERFACE



General technical data:



product brandname	SIRIUS
Product designation	Connection cable/length 0.1 m/flat
Design of the product	For connection of the system components
Ambient temperature	
• during storage	-40 ... +80 °C
• during operation	-25 ... +60 °C
• during transport	-40 ... +80 °C

Certificates/ approvals:

General Product Approval	EMC	Test Certificates	Shipping Approval
 UL		 C-Tick	 ABS

[Typrüfbescheinigung/Werkszeugnis](#)

[spezielle Prüfbescheinigungen](#)

Shipping Approval	other
 BUREAU VERITAS  DNV  GL  PRS  RMRS	Bestätigungen

other
PROFISafe-Zertifizierung PROFINET-Zertifizierung  Profibus

Further information

Information- and Downloadcenter (Catalogs, Brochures,...)

<http://www.siemens.com/industrial-controls/catalogs>

Industry Mall (Online ordering system)

<https://mall.industry.siemens.com/mall/en/en/Catalog/product?mlfb=3UF7931-0AA00-0>

Cax online generator

<http://support.automation.siemens.com/WW/CAXorder/default.aspx?lang=en&mlfb=3UF7931-0AA00-0>

Service&Support (Manuals, Certificates, Characteristics, FAQs,...)

<https://support.industry.siemens.com/cs/ww/en/ps/3UF7931-0AA00-0>

Image database (product images, 2D dimension drawings, 3D models, device circuit diagrams, EPLAN macros, ...)

http://www.automation.siemens.com/bilddb/cax_de.aspx?mlfb=3UF7931-0AA00-0&lang=en

