

DOOR MOUNTED ROTARY OPERATOR EMERGENCY-OFF IEC IP65 WITH DOOR INTERLOCKING ACCESSORY FOR 3VA15/25 1000



Model	
Product brand name	SETRON
Product designation	Accessories
Product version	Door-coupling rotary operating mechanism
Accessories	Door-coupling rotary operating mechanisms
General technical data	
Protection class IP	IP65
Mechanical Design	
Net weight	3 857 g
Certificates	

General Product Approval	EMC	Declaration of Conformity	Shipping Approval	other
Miscellaneous 	 RCM	 EG-Konf.	 LRS	Manufacturer Declaration

other
Miscellaneous

Further information

Information- and Downloadcenter (Catalogs, Brochures,...)

<http://www.siemens.com/lowvoltage/catalogs>

Industry Mall (Online ordering system)

<https://mall.industry.siemens.com/mall/en/en/Catalog/product?mlfb=3VA9687-0FK25>

Service&Support (Manuals, Certificates, Characteristics, FAQs,...)

<https://support.industry.siemens.com/cs/ww/en/ps/3VA9687-0FK25>

Image database (product images, 2D dimension drawings, 3D models, device circuit diagrams, ...)

http://www.automation.siemens.com/bilddb/cax_en.aspx?mlfb=3VA9687-0FK25

CAX-Online-Generator

<http://www.siemens.com/cax>

Tender specifications

<http://www.siemens.com/specifications>

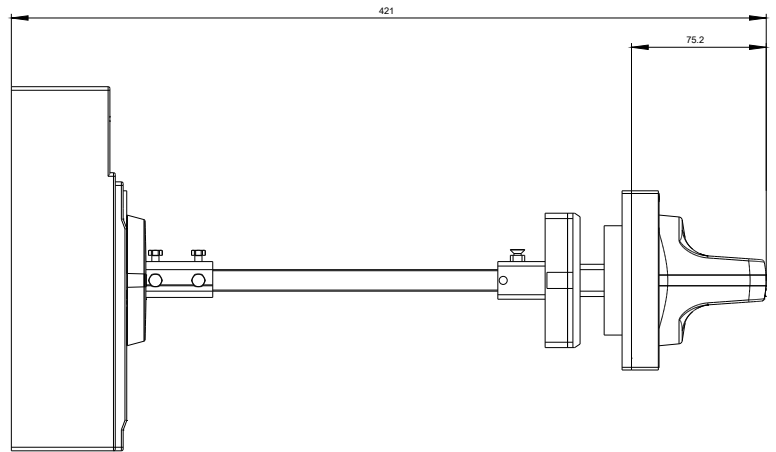
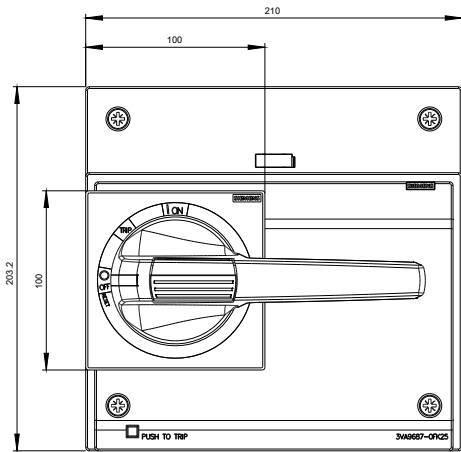

last modified:

11/19/2019