

circuit-breaker VL 400N standard breaking capacity $I_{cu} = 55\text{kA}$, 415V AC 3-pole, plant protection electronic trip unit ETU10 LI $I_n = 400\text{A}$, rated current $I_r = 160 \dots 400\text{A}$, overload protection, $i_t = 1.25$ to $11 \times I_n$, short-circuit protection marine APproval for Irs, Dnv and gl

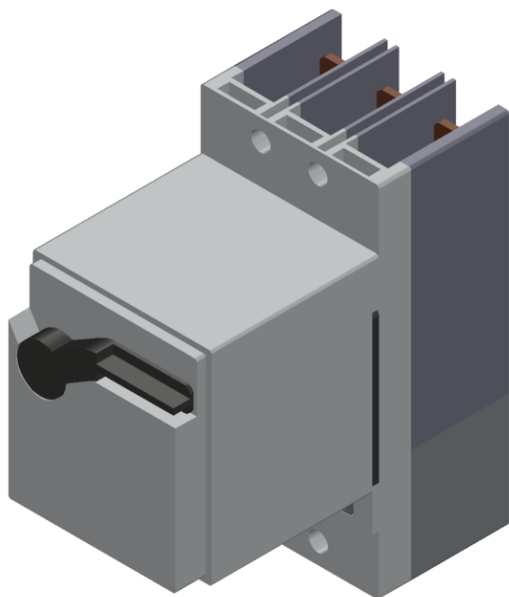

Model	
Design of the operating mechanism	toggle handle
Type of the driving mechanism / motor drive	Yes
Design of the overcurrent release	ETU10

General technical data	
Number of poles	3
Size of the circuit-breaker	3VL4
Electrical endurance (switching cycles) / typical	10 000
Usage category	A
Performance class for circuit breaker	N
Mechanical service life (switching cycles) / typical	20 000
Reference code / acc. to DIN 40719 extended according to IEC 204-2 / acc. to IEC 750	Q
Operating frequency / maximum	120 1/s

Voltage	
Rated operational voltage U _e / max.	690 V
Insulation voltage	
• rated value	800 V
• at AC / rated value	800 V
Surge voltage resistance / rated value	8 kV

Protection class	
Protection class IP	IP20
Protective function of the overcurrent release	LI

Electricity	
Operating current / at 45 °C / rated value	400 A
Continuous current / rated value	400 A
Derating temperature / for the rated value of the continuous current	50 °C
Adjustable pick-up value current	
• of the current-dependent overload release / Full-scale value	400 A
• of instantaneous short-circuit trip unit / initial value	500 A
• of instantaneous short-circuit trip unit / Full-scale value	4 400 A

Main circuit	
Operating frequency	
• 1 / rated value	50 Hz
• 2 / rated value	60 Hz
Operating voltage	
• rated value / maximum	690 V

<ul style="list-style-type: none"> • for main current circuit / at AC / at 50 Hz / maximum 	690 V
<ul style="list-style-type: none"> • for main current circuit / at AC / at 60 Hz / maximum 	690 V
<ul style="list-style-type: none"> • for main current circuit / at DC / maximum 	500 V
Operating current	
<ul style="list-style-type: none"> • at 40 °C / rated value 	400 A
<ul style="list-style-type: none"> • at 50 °C / rated value 	400 A
<ul style="list-style-type: none"> • at 55 °C / rated value 	380 A
<ul style="list-style-type: none"> • at 60 °C / rated value 	380 A
<ul style="list-style-type: none"> • at 65 °C / rated value 	320 A
<ul style="list-style-type: none"> • at 70 °C / rated value 	320 A

Auxiliary circuit

Number of CO contacts / for auxiliary contacts	0
Number of NC contacts / for auxiliary contacts	1
Number of NO contacts / for auxiliary contacts	1

Suitability

Suitability for use	system protection
---------------------	-------------------

Adjustable parameters

Adjustable pick-up value current / of the current-dependent overload release / initial value	160 A
--	-------

Product details

Product component	
<ul style="list-style-type: none"> • Trip indicator 	No
<ul style="list-style-type: none"> • Auxiliary switch 	Yes
<ul style="list-style-type: none"> • Voltage trigger 	No
<ul style="list-style-type: none"> • undervoltage release 	Yes
<ul style="list-style-type: none"> • undervoltage release with leading contact 	No
Product extension / optional / motor drive	No

Product function

Product function	
<ul style="list-style-type: none"> • of thermal overload trip unit 	adjustable
<ul style="list-style-type: none"> • Ground fault protection 	No
<ul style="list-style-type: none"> • for neutral conductors / Short-circuit and overload proof 	No
<ul style="list-style-type: none"> • Overload protection 	Yes

Short circuit

Operational short-circuit current breaking capacity (Ics)	
<ul style="list-style-type: none"> • at 240 V / rated value 	65 kA

<ul style="list-style-type: none"> • at 415 V / rated value • at 500 V / rated value • at 690 V / rated value 	<p>55 kA</p> <p>20 kA</p> <p>8 kA</p>
Maximum short-circuit current breaking capacity (Icu) <ul style="list-style-type: none"> • at 240 V / rated value • at 415 V / rated value • at 440 V / rated value • at 480 V / acc. to NEMA / rated value • at 500 V / rated value • at 600 V / acc. to NEMA / rated value • at 690 V / rated value 	<p>65 kA</p> <p>55 kA</p> <p>35 kA</p> <p>35 kA</p> <p>25 kA</p> <p>20 kA</p> <p>15 kA</p>

Connections

Arrangement of electrical connectors / for main current circuit	front side
Type of connectable conductor cross-sections <ul style="list-style-type: none"> • for main contacts / with flexible busbar • for main contacts / solid • for main contacts / finely stranded / with core end processing • for main contacts / stranded • for auxiliary contacts / solid • for auxiliary contacts / finely stranded / with core end processing 	<p>25 x 10</p> <p>50 ... 300 mm²</p> <p>50 ... 240 mm²</p> <p>50 ... 300 mm²</p> <p>0.75 ... 1.5 mm²</p> <p>0,75 ... 1.0 mm²</p>
Type of electrical connection / for main current circuit	screw-type terminals

Mechanical Design





Height	279.5 mm
Width	139 mm
Depth	163.5 mm
Mounting type	fixed mounting



Environmental conditions

Ambient temperature <ul style="list-style-type: none"> • during operation / minimum • during operation / maximum • during storage / minimum • during storage / maximum 	<p>-25 °C</p> <p>70 °C</p> <p>-40 °C</p> <p>80 °C</p>
---	---

Certificates

Certificate of suitability	IEC, standard switching capacity (N)
Reference code <ul style="list-style-type: none"> • acc. to DIN EN 61346-2 	Q

General Product Approval	EMC	Declaration of Conformity	Test Certificates	Shipping Approval
 CCC	Miscellaneous  C-Tick	 EG-Konf.	Special Test Certificate  LRS	

Shipping Approval	other
 RINA	 RMRS

[Miscellaneous](#) [Confirmation](#) [Environmental Confirmations](#)

Further information

Information- and Downloadcenter (Catalogs, Brochures,...)

<http://www.siemens.com/lowvoltage/catalogs>

Industry Mall (Online ordering system)

<https://mall.industry.siemens.com/mall/en/en/Catalog/product?mlfb=3VL4740-1LB36-2HB1-Z L12+M22>

Service&Support (Manuals, Certificates, Characteristics, FAQs,...)

<https://support.industry.siemens.com/cs/ww/en/ps/3VL4740-1LB36-2HB1-Z L12+M22>

Image database (product images, 2D dimension drawings, 3D models, device circuit diagrams, ...)

http://www.automation.siemens.com/bilddb/cax_en.aspx?mlfb=3VL4740-1LB36-2HB1-Z L12+M22

CAX-Online-Generator

<http://www.siemens.com/cax>

Tender specifications

<http://www.siemens.com/specifications>