

circuit breaker VL1250N standard breaking capacity $I_{cu}=55kA$, 415V AC 3-pole, line protection trip unit ETU10, $I_n=1250A$, rated current $I_R=500...1250A$, overload protection, $I_l=1.25$ to $10 \times I_n$, short-circuit protection Undervoltage release 220...250 V AC Auxiliary/alarm switch mounting kit 2 AUX (1 NO+1 NC)+1 AS (1 NO) Motorized operating mechanism set up 220-250 V AC/DC

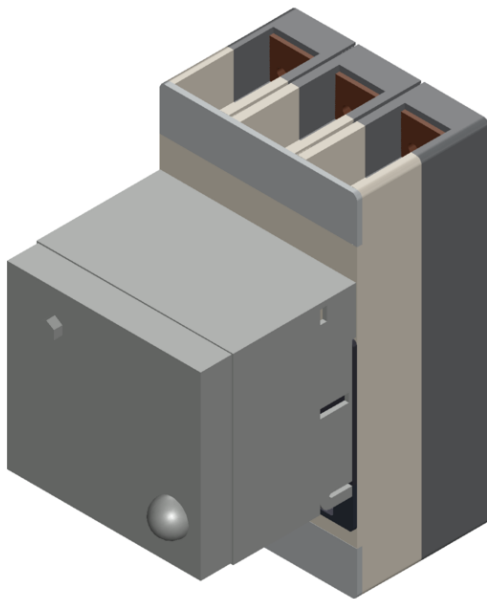

Model	
Design of the operating mechanism	toggle handle
Type of the driving mechanism / motor drive	Yes
Design of the overcurrent release	ETU10
General technical data	
Number of poles	3
Size of the circuit-breaker	3VL7

Electrical endurance (switching cycles) / typical	1 500
Usage category	A
Performance class for circuit breaker	N
Mechanical service life (switching cycles) / typical	3 000
Reference code / acc. to DIN 40719 extended according to IEC 204-2 / acc. to IEC 750	Q
Operating frequency / maximum	30 1/s

Voltage

Rated operational voltage U _e / max.	690 V
Insulation voltage	
• rated value	800 V
• at AC / rated value	800 V
Surge voltage resistance / rated value	8 kV

Protection class

Protection class IP	IP20
Protective function of the overcurrent release	LI

Electricity

Operating current / at 45 °C / rated value	1 250 A
Continuous current / rated value	1 250 A
Derating temperature / for the rated value of the continuous current	50 °C
Adjustable pick-up value current	
• of the current-dependent overload release / Full-scale value	1 250 A
• of instantaneous short-circuit trip unit / initial value	1 563 A
• of instantaneous short-circuit trip unit / Full-scale value	12 500 A

Main circuit

Operating frequency	
• 1 / rated value	50 Hz
• 2 / rated value	60 Hz
Operating voltage	
• rated value / maximum	690 V
• for main current circuit / at AC / at 50 Hz / maximum	690 V
• for main current circuit / at AC / at 60 Hz / maximum	690 V
Operating current	
• at 40 °C / rated value	1 250 A
• at 50 °C / rated value	1 250 A
• at 55 °C / rated value	1 187.5 A

• at 60 °C / rated value	1 187.5 A
• at 65 °C / rated value	1 000 A
• at 70 °C / rated value	1 000 A

Auxiliary circuit

Number of CO contacts / for auxiliary contacts	0
Number of NC contacts / for auxiliary contacts	1
Number of NO contacts / for auxiliary contacts	2

Suitability

Suitability for use	system protection
---------------------	-------------------

Adjustable parameters

Adjustable pick-up value current / of the current-dependent overload release / initial value	500 A
--	-------

Product details

Product component	
• Trip indicator	Yes
• Auxiliary switch	Yes
• Voltage trigger	No
• undervoltage release	Yes
• undervoltage release with leading contact	No
Product extension / optional / motor drive	No

Product function

Product function	
• of thermal overload trip unit	adjustable
• Ground fault protection	No
• for neutral conductors / Short-circuit and overload proof	No
• Overload protection	Yes

Short circuit

Operational short-circuit current breaking capacity (Ics)	
• at 240 V / rated value	35 kA
• at 415 V / rated value	28 kA
• at 500 V / rated value	20 kA
• at 690 V / rated value	10 kA
Maximum short-circuit current breaking capacity (Icu)	
• at 240 V / rated value	65 kA
• at 415 V / rated value	55 kA
• at 440 V / rated value	35 kA
• at 480 V / acc. to NEMA / rated value	25 kA
• at 500 V / rated value	25 kA

- at 600 V / acc. to NEMA / rated value 20 kA
- at 690 V / rated value 20 kA

Connections

Arrangement of electrical connectors / for main current circuit	front side
Type of connectable conductor cross-sections	
<ul style="list-style-type: none"> • for auxiliary contacts / solid 	0.75 ... 1.5 mm ²
<ul style="list-style-type: none"> • for auxiliary contacts / finely stranded / with core end processing 	0,75 ... 1.0 mm ²
Type of electrical connection / for main current circuit	screw-type terminals

Mechanical Design



Height	406.5 mm
Width	228.5 mm
Depth	333.5 mm
Mounting type	fixed mounting



Environmental conditions

Ambient temperature	
<ul style="list-style-type: none"> • during operation / minimum 	-25 °C
<ul style="list-style-type: none"> • during operation / maximum 	70 °C
<ul style="list-style-type: none"> • during storage / minimum 	-40 °C
<ul style="list-style-type: none"> • during storage / maximum 	80 °C

Certificates

Certificate of suitability	IEC, standard switching capacity (N)
Reference code	
<ul style="list-style-type: none"> • acc. to DIN EN 61346-2 	Q
<p>Waste electronic equipment must not be disposed as unsorted municipal waste, e.g. household waste. For disposing the waste electronic equipment it is necessary to observe the current local national/international regulations.</p> 	

General Product Approval		EMC	Declaration of Conformity	Test Certificates
 CCC	Miscellaneous	TSE	 C-Tick	 EG-Konf.
				Special Test Certificate

Shipping Approval		other			
 RINA	 RMRS	Confirmation	Environmental Conformations	Manufacturer Declaration	Miscellaneous

Further information

Information- and Downloadcenter (Catalogs, Brochures,...)

<http://www.siemens.com/lowvoltage/catalogs>

Industry Mall (Online ordering system)

<https://mall.industry.siemens.com/mall/en/en/Catalog/product?mlfb=3VL7712-1SB36-2HE1-Z M22>

Service&Support (Manuals, Certificates, Characteristics, FAQs,...)

<https://support.industry.siemens.com/cs/ww/en/ps/3VL7712-1SB36-2HE1-Z M22>

Image database (product images, 2D dimension drawings, 3D models, device circuit diagrams, ...)

http://www.automation.siemens.com/bilddb/cax_en.aspx?mlfb=3VL7712-1SB36-2HE1-Z M22

CAX-Online-Generator

<http://www.siemens.com/cax>

Tender specifications

<http://www.siemens.com/specifications>