

Conductive

VEGATOR 256C
VEGATOR 532
VEGATOR 631



Product Information



VEGA

Content

1	Product description	3
2	Type overview	4
3	Mounting instructions.	5
4	Connecting to power supply	
4.1	Preparing the connection	7
4.2	Wiring plan	7
5	Operation	
5.1	Operating system - VEGATOR 256C	10
5.2	Adjustment elements - VEGATOR 256C	10
5.3	Operating system - VEGATOR 532	10
5.4	Adjustment elements - VEGATOR 532	10
5.5	Operating system - VEGATOR 631	12
5.6	Adjustment elements - VEGATOR 631	12
6	Technical data	14
7	Dimensions.	18
8	Product code	19

Take note of safety instructions for Ex applications



Please note the Ex specific safety information which you will find on our homepage www.vega.com/services/downloads and which come with the appropriate instrument with Ex approval. In hazardous areas you should take note of the appropriate regulations, conformity and type approval certificates of the sensors and power supply units. Each VEGATOR with Ex approval is an associated, intrinsically safe instrument and must not be installed in hazardous areas.

1 Product description

VEGATOR

VEGATOR signal conditioning instruments power the connected sensor and output level-dependent switching signals via integrated relay outputs.

VEGATOR 256C, 532 and 632 signal conditioning instruments are suitable for level detection in conjunction with conductive probes series EL.

Functional principle

An alternating voltage is connected to two electrodes with the conductive measurement. The medium is in contact with the electrodes and conducts the current according to the resistor. E.g. reaching of a certain level in a vessel is detected by the sensor and transferred to the VEGATOR signal conditioning instrument for further processing. The measuring system can be adapted to the conductivity with VEGATOR.

Area of application

The instruments are mainly used for level detection or pump control.

The different signal conditioning instruments have various mounting options.

- Carrier rail mounting - VEGATOR 256C, 631
- Wall mounting - VEGATOR 256C, 631
- 19"-carrier - VEGATOR 532
- Single housing (type 505) - VEGATOR 532

2 Type overview

VEGATOR 256C



Applications: Single level detection
 Functions: Adjustment
 Sensor input: 1 sensor input
 Outputs: 1 relay output
 Indication on the instrument: Control lamp for indication of the relay status.

VEGATOR 532

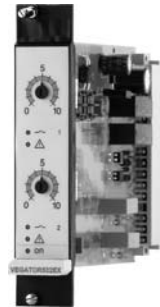

Applications: Double level detection, double pump control
 Functions: Adjustment
 Sensor input: 2 sensor inputs
 Outputs: 2 relay outputs, 2 transistor outputs
 Indication on the instrument: 2 control lamps for indication of the relay conditions, 2 fault signal lamps

VEGATOR 631



Applications: Level detection, pump control
 Functions: Adjustment
 Sensor input: 1 sensor input
 Outputs: 1 relay output, 1 transistor output
 Indication on the instrument: 1 control lamp for indication of the relay condition, 1 fault signal lamp

3 Mounting instructions

3.1 VEGATOR 256C

VEGATOR 256C can be mounted in the following ways:

- Carrier rail 35 x 7.5 according to EN 50022
- Wall mounting

You can either mount the signal conditioning instrument directly on the wall with 2 screws or plug it onto a carrier rail.

Carrier rail mounting

Place the signal conditioning instrument onto the carrier rail (35 x 7,5 according to EN 50022) from below and press the instrument against the carrier rail until it snaps in.

Wall mounting

Fasten the instrument directly to the wall by means of two screws (max. \varnothing 3 mm/0.12 in).

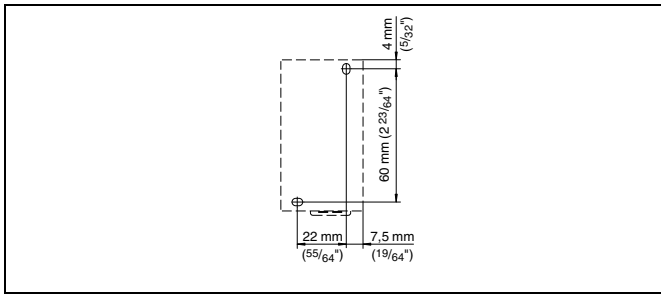

Fig. 1: Drilling template VEGATOR 256C

3.2 VEGATOR 532

VEGATOR 532 can be mounted in the following ways:

- Mounting in single housing type 505 Ex
- Mounting in carrier rail BGT596 (Ex)

Mounting in single housing type 505 Ex

The socket of the single housing type 505 Ex can either be screwed directly to the mounting plate or can be plugged onto a carrier rail TS35 x 7.5 according to EN 50022 or TS32 according to EN 50035.

You can find further information on mounting in the operating instructions manual of the single housing type 505 Ex.



VEGATOR 532 in Ex version is an auxiliary, intrinsically safe instrument and must not be installed in hazardous areas.

Mounting in carrier rail BGT596 (Ex)

Mount the respective module (standard or Ex version) to your carrier BGT596 or BGT596 Ex.

The female multipoint connector is available in the following connection versions:

- Wire-Wrap standard connection 1 x 1 mm

- Plug connection 2,8 x 0.8 mm
- Termini-Point standard connection 1,6 x 0.8 mm
- Soldering connection
- Screw terminals 2 x 0.5 mm²

You can find further information on mounting in the operating instructions manual of the carrier.



When you are mounting the signal conditioning instrument with Ex approval in a carrier, you have to use a VEGA Ex module.

In Ex applications, a protection of IP 20 must be maintained. Cover the gaps or free module from the front with appropriate blind covers.

Keep a distance of at least 2 TE (10 mm/0.4 in) to the module cards of other manufacturers.

If you want to mount VEGATOR 532 in the complete left position in the carrier, you have to mount a blind cover with at least 4 TE (20 mm/0.8 in) in front of the module of the signal conditioning instrument.

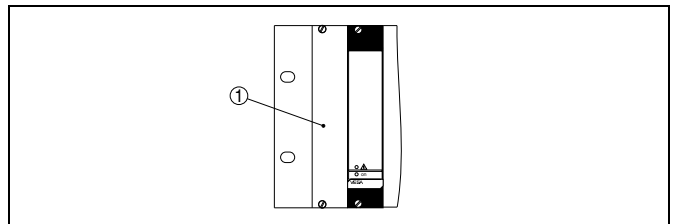

Fig. 2: Distance to the carrier side

1 Blind cover

Instrument coding

All series 500 signal conditioning instruments are provided with different gaps dependent on type and version (mechanical coding).

The module is provided with coded pins that can be inserted to prevent accidental interchanging of the various instrument types.

3.3 VEGATOR 631

Installation location

Each series 600 VEGATOR consists of the actual signal conditioning instrument as well as a plug-in socket for carrier rail mounting. Because it has protection class IP 30 or IP 20, the instrument is intended to be used in switching cabinets.



VEGATOR 631 in Ex version is an auxiliary, intrinsically safe instrument and must not be installed in hazardous areas.

The Ex separating chamber must be plugged in before starting with the setup of the Ex versions of VEGATOR 631. The instrument must not be opened.

Mounting

The plug-in socket is constructed for carrier rail mounting according to EN 50022. Power supply is connected to terminals 17 and 18. For neighbouring series 600 signal conditioning instruments, it is possible to continue connection L1 and N directly via the supplied bridges.

Instrument coding

All series 600 signal conditioning instruments are provided with different gaps dependent on type and version (mechanical coding).

The plug-in socket is provided with coded pins that can be inserted to prevent accidental interchanging of the various instrument types.

4 Connecting to power supply

4.1 Preparing the connection

Note safety instructions

Always keep in mind the following safety instructions:

- Connect only in the complete absence of line voltage
- If overvoltage surges are expected, overvoltage arresters should be installed

Take note of safety instructions for Ex applications



In hazardous areas you should take note of the appropriate regulations, conformity and type approval certificates of the sensors and power supply units.

Select power supply

The power supply can be 20 ... 253 V AC, 50/60 Hz or 20 ... 253 V DC.

Selecting connection cable

Power supply of VEGATOR is connected with standard cable according to the national installation standards.

Standard two-wire cable without screening can be used to connect sensors. If electromagnetic interference is expected, screened cable must be used.

Cable screening and grounding

Connect the cable screen on both ends to ground potential. In the sensor, the screen must be connected directly to the internal ground terminal. The ground terminal outside on the housing must be connected to the potential equalisation.

If potential equalisation currents are expected, the screen connection on VEGATOR must be made via a ceramic capacitor (e.g. 1 nF, 1500 V). The low frequency potential equalisation currents are thus suppressed, but the protective effect against high frequency interference signals remains.

Select connection cable for Ex applications



Take note of the corresponding installation regulations for Ex applications. In particular, make sure that no potential equalisation currents flow over the cable screen. In case of grounding on both sides this can be achieved by the use of a capacitor or a separate potential equalisation.

4.2 Wiring plan

VEGATOR 256C

Level detection

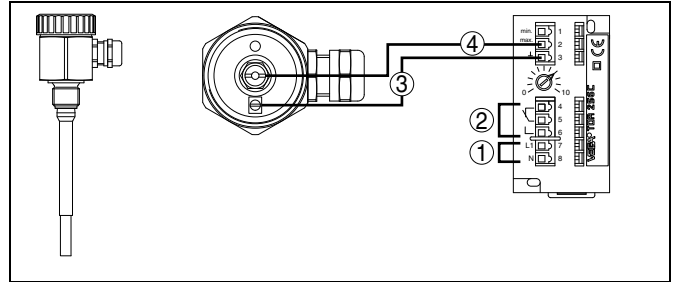

Fig. 3: Level detection - VEGATOR 256C

- 1 Power supply
- 2 Relay output
- 3 Mass
- 4 Max.

Pump control (min./max. control)

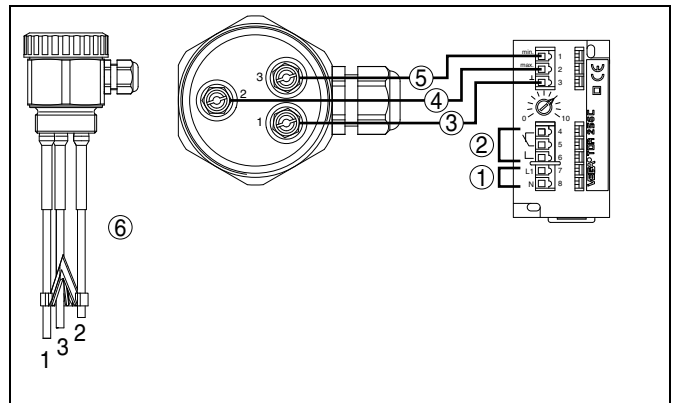

Fig. 4: Pumpen control - VEGATOR 256C

- 1 Power supply
- 2 Relay output
- 3 Mass
- 4 Max.
- 5 Min.
- 6 Probe, e.g. EL3



Note:

Multiple rod probes connected to several signal conditioning instruments or to a multiple channel instrument need a ground rod to keep the signal conditioning instruments from influencing each other.

If there are several VEGATOR, it is absolutely necessary that they be connected identically, i.e. the first supply line to all no. 7 terminals and the second supply line to all no. 8 terminals. Exchanging no. 7 and no. 8 or connecting to different phases is not permitted.

VEGATOR 532

Double level detection

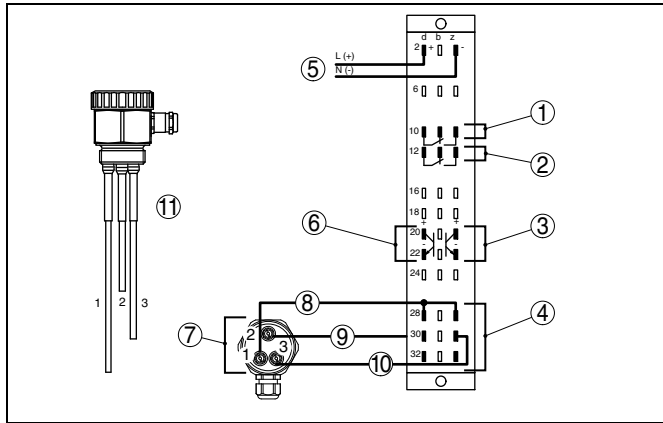

Fig. 5: Double level detection - VEGATOR 532

- 1 Relay output 1
- 2 Relay output 2
- 3 Transistor output 2
- 4 Sensor input - Channel 2
- 5 Voltage supply
- 6 Transistor output 1
- 7 Sensor input - Channel 1
- 8 Mass
- 9 Max.
- 10 Min.
- 11 Probe, e.g. EL3

Pump control (min./max. control)

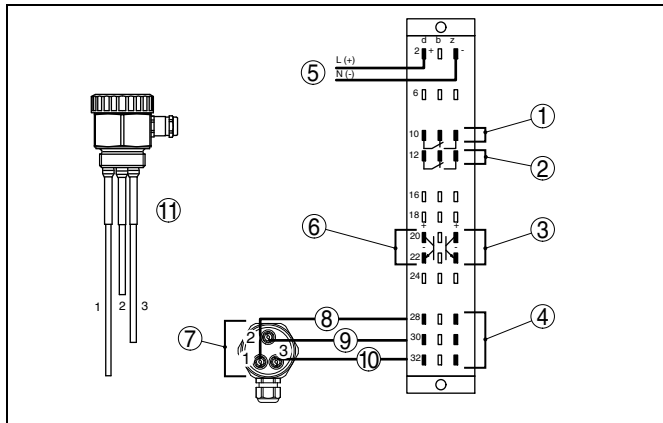

Fig. 6: Pump control (min./max. control) - VEGATOR 532

- 1 Relay output 1
- 2 Relay output 2
- 3 Transistor output 2
- 4 Sensor input - Channel 2
- 5 Voltage supply
- 6 Transistor output 1
- 7 Sensor input - Channel 1
- 8 Mass
- 9 Max.
- 10 Min.
- 11 Probe, e.g. EL3



Note:

Multiple rod probes connected to several signal conditioning instruments or to a multiple channel instrument need a ground rod to keep the signal conditioning instruments from influencing each other.

Double pump control (min./max.)

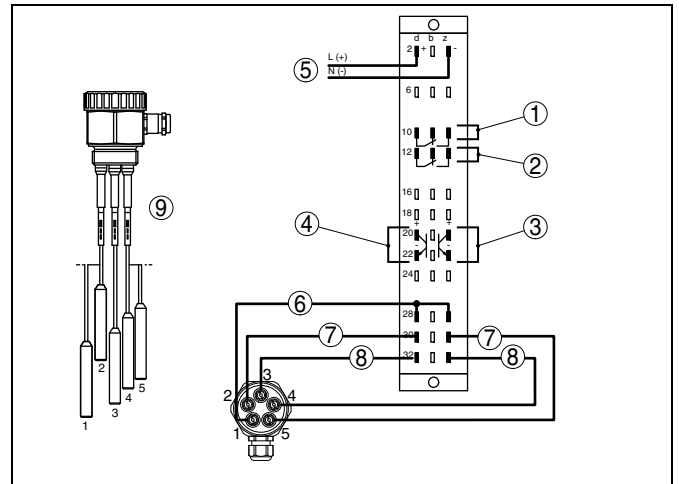

Fig. 7: Double pump control - VEGATOR 532

- 1 Relay output 1
- 2 Relay output 2
- 3 Transistor output 2
- 4 Transistor output 1
- 5 Voltage supply
- 6 Mass
- 7 Max.
- 8 Min.
- 9 Probe, e.g. EL5

VEGATOR 532 Ex with housing type 505

The terminal designation for the voltage supply and the relay and transistor outputs corresponds to that of the multipoint connector.

Only the connection of the probes must be carried out according to the following illustration.

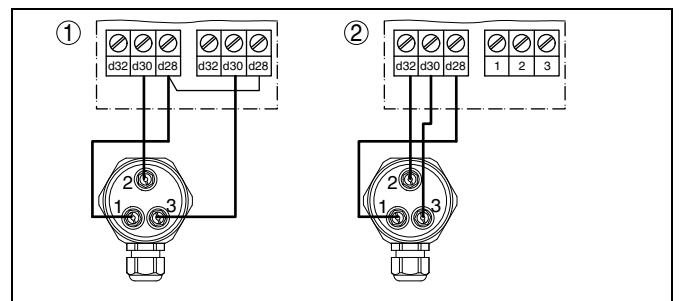

Fig. 8: Deviating terminal assignment - Housing type 505

- 1 Double level detection
- 2 Pump control (min./max. control)

VEGATOR 631

Level detection

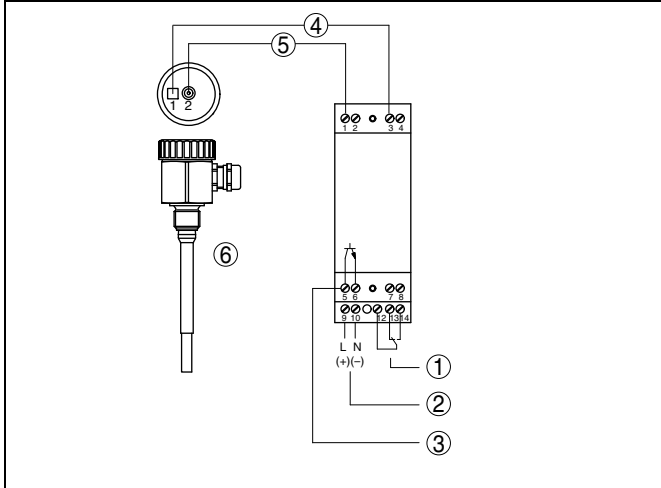

Fig. 9: Level detection - VEGATOR 631

- 1 Relay output
- 2 Power supply
- 3 Transistor output
- 4 Mass
- 5 Max.
- 6 Probe, e.g. EL1

Pump control (min./max. control)

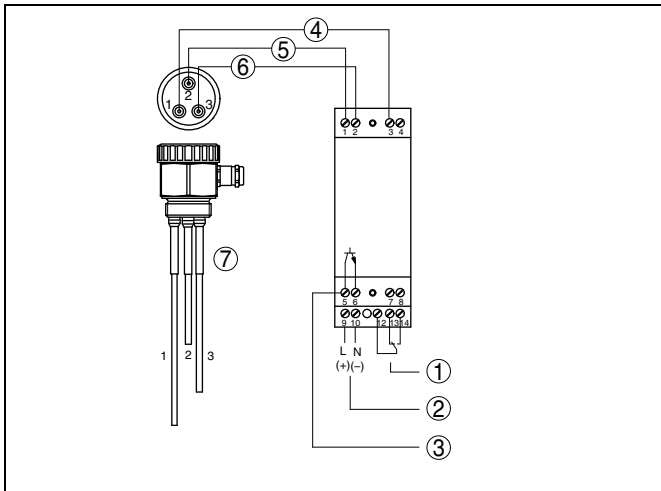

Fig. 10: Pumpen control - VEGATOR 631

- 1 Relay output
- 2 Power supply
- 3 Transistor output
- 4 Mass
- 5 Max.
- 6 Min.
- 7 Probe, e.g. EL3

need a ground rod to keep the signal conditioning instruments from influencing each other.

Pump control (min./max.) with overfill protection

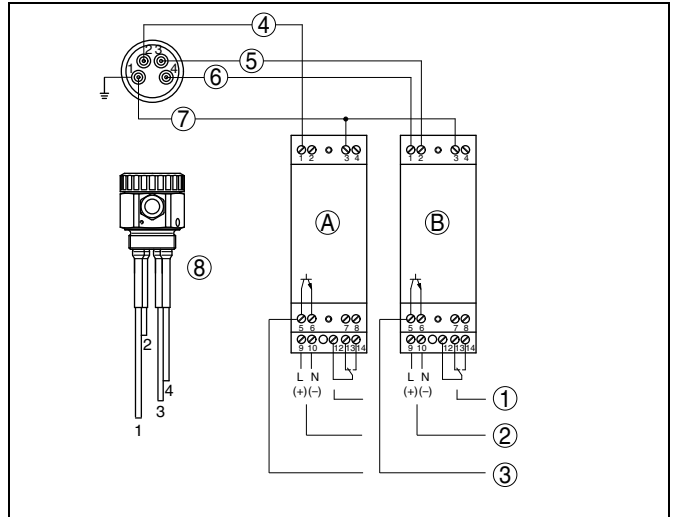

Fig. 11: Pump control with overfill protection - VEGATOR 631

- 1 Relay output
- 2 Power supply
- 3 Transistor output
- 4 Max. overfill protection
- 5 Min.
- 6 Max.
- 7 Mass
- 8 Probe, e.g. EL3
- A Overfill protection
- B Min./max. control

33065-EN-071204

Note:
Multiple rod probes connected to several signal conditioning instruments or to a multiple channel instrument

5 Operation

5.1 Operating system - VEGATOR 256C

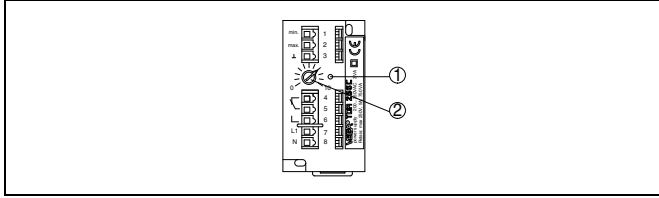

Fig. 12: Indicating and adjustment elements

- 1 Signal lamp - Relay output
- 2 Potentiometer for switching point adjustment

5.2 Adjustment elements - VEGATOR 256C

Control lamp

The yellow relay control lamp (LED) shows the switching condition of the relay.

Generally the relay control lamp shows the activated (energized) condition of the relay.

A dark relay control lamp means that the relay is deenergised.

Potentiometer for switching point adjustment

A potentiometer for switching point adaptation is located on the front plate of the signal conditioning instrument. With this potentiometer you can adapt the measuring system to the conductivity of the product.

5.3 Operating system - VEGATOR 532

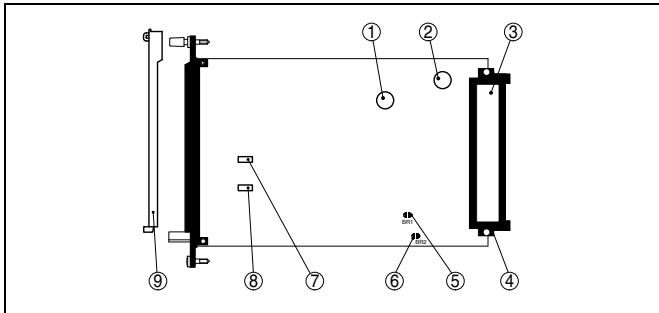

Fig. 13: Indicating and adjustment elements - Circuit board

- 1 Ex fuse T50 mA/253 V
- 2 Mains fuse T1 A/253 V
- 3 Wiring plan
- 4 Connection plug board
- 5 Soldering bridge for fault message adjustment - Channel 1
- 6 Soldering bridge for fault message adjustment - Channel 2
- 7 Selection switch (DIL switch) mode AB - Channel 1
- 8 Selection switch (DIL switch) mode AB - Channel 2
- 9 Transparent cover (lead-sealable)

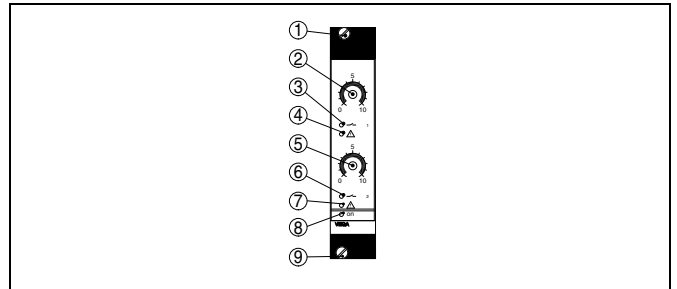

Fig. 14: Indicating and adjustment elements - Front plate

- 1 Fixing screw (lead-sealable)
- 2 Potentiometer for switching point adjustment - Channel 1
- 3 Control lamp - Relay output (LED) - Channel 1
- 4 Control lamp - Fault message (LED) - Channel 1
- 5 Potentiometer for switching point adjustment - Channel 2
- 6 Control lamp - Relay output (LED) - Channel 2
- 7 Control lamp - Fault message (LED) - Channel 2
- 8 Control lamp - power supply (LED)
- 9 Fixing screw

5.4 Adjustment elements - VEGATOR 532

Control lamps

Control lamps (LED) in the front plate indicate operation, switching status and fault signal.

- Green
 - Operating control lamp
 - Mains voltage on, instrument is operating
- Red
 - Failure lamp
 - Fault on the sensor circuit due to sensor failure or line break
 - If the fail safe relay is deenergized, the red failure lamp will light
- Yellow
 - Relay control lamp
 - The yellow relay control lamp reacts depending on the set mode (A/B)
 - Generally the relay control lamp shows the activated (energized) condition of the relay
 - A dark relay control lamp means that the relay is deenergised (transistor blocks)

Potentiometer for switching point adjustment

Two potentiometers for switching point adaptation are located on the front plate of the signal conditioning instrument. With this potentiometer you can adapt the measuring system to the conductivity of the medium separately for each channel.

Use a small screwdriver to carry out adjustments on the potentiometer.

DIL switch - Mode

One slide switch per channel is located on the circuit board of the signal conditioning instrument. Set the requested mode before inserting VEGATOR because the switch will no longer be accessible in assembled condition.

- A - Max. detection or overflow protection
- B - Min. detection or dry run detection

Selection of the mode

You can set mode A or B by means of the selection switch.

Mode A

Preferrably as overflow protection, compulsory as overfill protection.

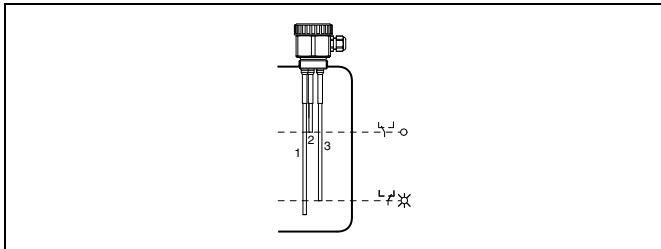

Fig. 15: Mode A - Overfill protection

Means with covered max. electrode:

- Relay (channel 1) deenergizes, connection d10/b10 connected through relay
- Transistor output (channel 1) blocks
- Control lamp output (channel 1) extinguishes

Means with uncovered max. electrode (level detection) or min. electrode (pump control):

- Relay (channel 1) energizes, connection d10/z10 connected through relay
- Transistor output (channel 1) conducts
- Control lamp output (channel 1) lights

Mode B

Preferrably as dry run protection system.

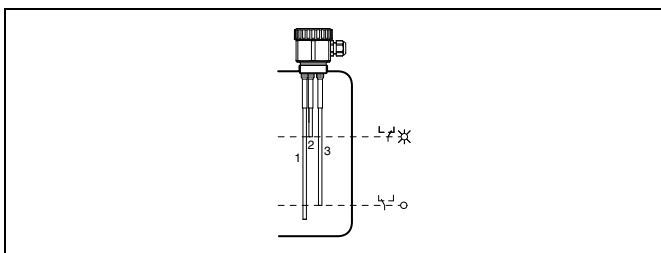

Fig. 16: Mode B - Dry run protection

Means with covered max. electrode:

- Relay (channel 1) energizes, connection d10/z10 connected through relay
- Transistor output (channel 1) conducts
- Control lamp output (channel 1) lights

Means with uncovered max. electrode (single point control) or min. electrode (double point control):

- Relay (channel 1) deenergizes, connection d10/b10 connected through relay
- Transistor output (channel 1) blocks
- Control lamp output (channel 1) extinguishes

Fault signal adjustment, bridge

To monitor the electrodes and their circuits, a resistor of 220 kΩ must be mounted between connection 1 and connection 2 in the connection housing of the probe, i.e. with single point control, the measuring and earth electrodes are monitored, and with double point control, the max. and earth electrodes are monitored.

If you want to use both channels for two separate measurements (no two-point control), the measuring electrodes are monitored, e.g. ground and max. electrode of channel 1 (connection d30 and d32) and ground and min. electrode of channel 2 (connection z30 and z32).

By doing this, a failure is triggered separately for each channel. In case of failure:

- the channel-specific control lamp fault signal lights
- the relay output of the concerned channel deenergizes
- the transistor output of the concerned channel is blocked
- The functions of the interferred channel remain

For probes with 220 kΩ resistor, a soldering bridge must be closed on the circuit board of VEGATOR.

- Channel 1 - Soldering bridge BR1
- Channel 2 - Soldering bridge BR2

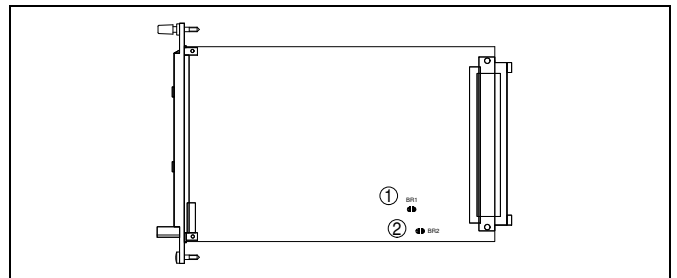

Fig. 17: Fault message adjustment - Soldering bridges

- 1 Soldering bridge for fault message adjustment of channel 1 (BR1)
- 2 Soldering bridge for fault message adjustment of channel 2 (BR2)



Note:

The line monitoring and the fault signal are inactive with this bridge.



If a measuring system is used as part of an overfill protection system, the bridge on the signal conditioning instrument must not be closed. With Ex probes, the resistor in the probe housing is already present.

5.5 Operating system - VEGATOR 631

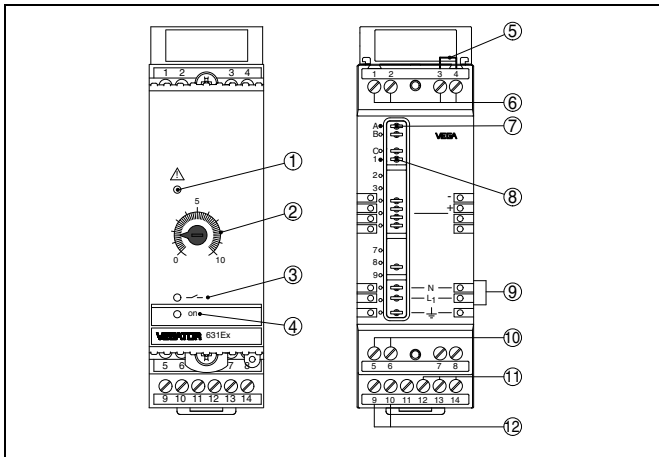

Fig. 18: Indicating and adjustment elements

- 1 Control lamp - Fault signal (LED red)
- 2 Potentiometer for switching point adjustment
- 3 Control lamp - Output (LED yellow)
- 4 Control lamp - Power supply (LED green)
- 5 Bridge for adjusting the fault signal
- 6 Terminals for probe
- 7 Function coding Ex version
- 8 Instrument coding
- 9 Sockets for bridges
- 10 Transistor output
- 11 Relay output
- 12 Power supply

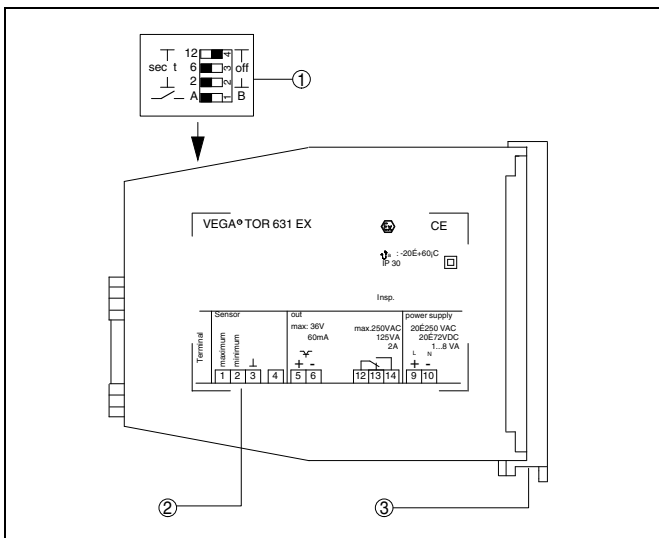

Fig. 19: Indicating and adjustment elements

- 1 DIL switch block
- 2 Type label
- 3 Transparent cover

5.6 Adjustment elements - VEGATOR 631

Control lamps

Control lamps (LED) in the front plate indicate operation, switching status and fault signal.

- Green
 - Operating control lamp
 - Mains voltage on, instrument is operating
- Red
 - Failure lamp
 - Fault on the sensor circuit due to sensor failure or line break
 - If the fail safe relay is deenergized, the red failure lamp will light
- Yellow
 - Relay control lamp
 - The yellow relay control lamp reacts depending on the set mode (A/B)
 - Generally the relay control lamp shows the activated (energized) condition of the relay
 - A dark relay control lamp means that the relay is deenergised (transistor blocks)

Potentiometer for switching point adjustment

A potentiometer for switching point adaptation is located on the front plate of the signal conditioning instrument. With this potentiometer you can adapt the measuring system to the conductivity of the product.

DIL switch block

On top to the side (covered when mounted) there is a DIL switch block with four switches. The individual switches are assigned as follows:

- 1 - A/B mode
 - A - Max. detection or overflow protection
 - B - Min. detection or dry run detection
- 2 - Integration time 2 s
- 3 - Integration time 6 s
- 4 - Integration time 12 s

With switch 1 you can adjust the mode (A - overflow protection or B - dry run protection).

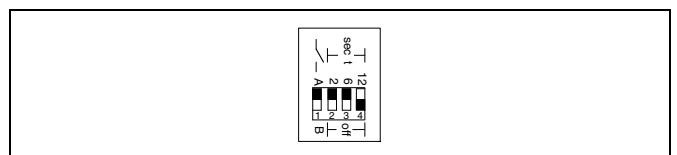

Fig. 20: DIL switch block

In the example (see previous illustration), mode A (max. detection or overflow protection) is selected (switch 1). The integration time is set to 8 seconds (switch 2, 3 and 4).

You can adjust the integration time accordingly with switch 2, 3 and 4. The time periods of the activated time switches add up. The set time applies to the switch on as well as the switch off delay.

Fault signal adjustment, bridge

To implement line monitoring, you have to mount a resistor of 220 kΩ between terminals 1 and 2 in the connection housing of the probe. This means that with single point control, the measuring and ground electrode are monitored and with two-point control, the max. and ground electrode.

When a fault message is generated, the switching output is simultaneously activated.

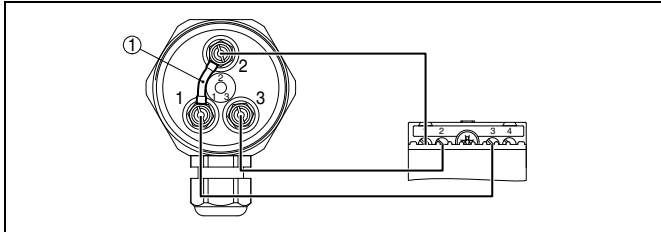

Fig. 21: Measuring system **with** line monitoring

1 Resistor (220 kΩ)

If a fault message is not wanted, a bridge must be provided on the signal conditioning instrument instead of the resistor in the connection housing of the probe.



Note:

The line monitoring and the fault signal are inactive with this bridge.

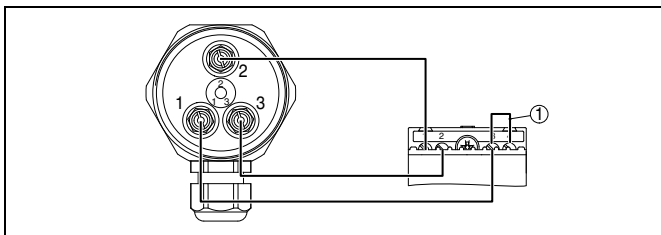

Fig. 22: Measuring system **without** line monitoring

1 Bridge between terminal 3 and 4



If a measuring system is used as part of an overfill protection system, the bridge on the signal conditioning instrument must not be closed. With Ex probes, the resistor in the probe housing is already present.

You can find the electrical connection of VEGATOR in the operating instructions manual of the corresponding signal conditioning instrument.

Line monitoring



With Ex versions, this resistor of 220 kΩ is already integrated Ex factory in the connection housing of the probe. The Ex measuring system (max. and ground connection cable of the probe to the signal conditioning instrument) is generally monitored for line break.

Mode selection switch

You can set mode A or B by means of the selection switch.

Mode A

Preferrably as overflow protection, compulsory as overfill protection.

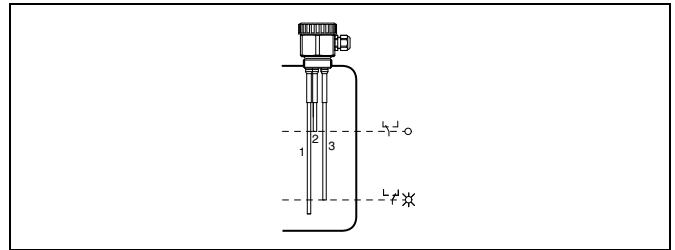

Fig. 23: Mode A - Overfill protection

Means with covered max. electrode:

- Relay deenergises, connection 12 - 13 is connected through relay
- Transistor output blocks
- Control lamp - Output extinguishes

Means with uncovered max. electrode (level detection) or min. electrode (pump control):

- Relay energises, connection 12 - 14 is connected through relay
- Transistor output is conductive
- Control lamp - Output lights

Mode B

Preferrably as dry run protection system.

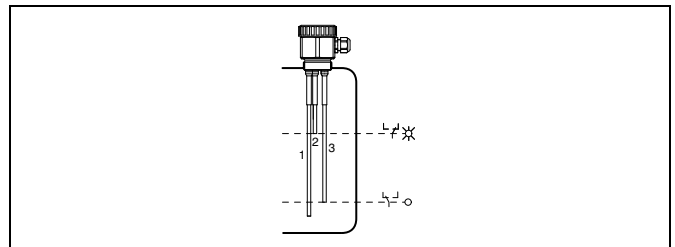

Fig. 24: Mode B - Dry run protection

Means with covered max. electrode:

- Relay energises, connection 12 - 14 is connected through relay
- Transistor output is conductive
- Control lamp - Output lights

Means with uncovered max. electrode (level detection) or min. electrode (pump control):

- Relay deenergises, connection 12 - 13 is connected through relay
- Transistor output blocks
- Control lamp - Output extinguishes

6 Technical data

General data

VEGATOR 256C

Series Instrument for wall mounting or mounting on carrier rail 35 x 7.5 or 35 x 15 according to EN 50022

Weight 170 g (6 oz)
Housing material Noryl SE100, Lexan 920A

VEGATOR 532

Series 19" module card, multipoint connector according to DIN 41612, including transparent cover (lockable)

Weight 150 g (5.3 oz)

VEGATOR 631

Series Module unit with plug-in socket for mounting on carrier rail 35 x 7.5 or 35 x 5 according to EN 50022

Weight 170 g (6 oz)
Housing material Noryl SE100, Lexan 920A
Socket material Noryl SE100, Noryl SE1 GFN3

Voltage supply

VEGATOR 256C

Supply voltage
– Standard 200 ... 253 V AC, 50/60 Hz
– optional 24 V, 42 V, 48 V, 100 ... 130 V AC (+10 %, -15 %)
Max. power consumption 1 VA

VEGATOR 532

Supply voltage 20 ... 53 V AC, 50/60 Hz, 20 ... 72 V DC
Max. power consumption 2 W, 3 VA
Fuse
– Supply area T 1 A, 253 V
– Switching off possibility min. 35 A at 253 V AC or 125 V DC

VEGATOR 631

Supply voltage 20 ... 253 V AC, 50/60 Hz, 20 ... 72 V DC
Max. power consumption 1.5 W (1 ... 9 VA)
Fuse
– Supply area T 315 mA, 253 V
– Switching off possibility min. 35 A at 253 V AC or 125 V DC

Sensor input

VEGATOR 256C

Quantity 1 x level detection or 1 x pump control (min./max.)
Response resistor 1 ... 200 kΩ adjustable
Meas. circuit approx. 12 V eff., max. 1 mA
Switching hysteresis 20 %

VEGATOR 532

Quantity 2 x level detection or 2 x pump control (min./max.)
Response resistor 1 ... 200 kΩ adjustable
Parallel resistor for fault monitoring 220 kΩ
Meas. circuit max. 5 V eff., max. 1 mA
Permissible line capacitance 1 x 100 nF or 2 x 70 nF with min./max. control
Switching hysteresis 15 %

VEGATOR 631

Quantity 1 x level detection or 1 x pump control (min./max.)
Response resistor 1 ... 200 kΩ adjustable
Parallel resistor for fault monitoring 220 kΩ
Meas. circuit max. 5 V eff., max. 1 mA

Permissible line capacitance	1 x 100 nF or 2 x 70 nF with min./max. control
Switching hysteresis	15 %

Relay output

VEGATOR 256C

Quantity	1 (1 x level detection)
Mode	Max. detection or overflow protection
Integration time	500 ms
Contact	Changeover contact (spdt)
Contact material	AgNi 0.15 hard gold-plated
Turn-on voltage	≥ 10 mV DC, ≤ 253 V AC, 253 V DC
Switching current	≥ 10 μ A DC, ≤ 5 A AC, 1 A DC
Breaking capacity	≤ 750 VA, ≤ 54 W

VEGATOR 532

Quantity	2
Mode	A/B switch (A - max. detection or overflow protection, B - min. detection or dry run protection) adjustable separately for each channel
Integration time	500 ms
Contact	1 spdt for each output
Contact material	AgNi, hard gold-plated
Turn-on voltage	≥ 10 mV DC, ≤ 253 V AC, 253 V DC
Switching current	≥ 10 μ A DC, ≤ 3 A AC, 1 A DC
Breaking capacity	≤ 750 VA, ≤ 54 W DC

VEGATOR 631

Quantity	1
Mode	A/B switch (A - max. detection or overflow protection, B - min. detection or dry run protection)
Integration time	500 ms
Contact	1 spdt for each output
Contact material	AgNi, hard gold-plated
Turn-on voltage	≥ 10 mV DC, ≤ 253 V AC, 253 V DC
Switching current	≥ 10 μ A DC, ≤ 3 A AC, 1 A DC
Breaking capacity	≤ 750 VA, ≤ 54 W DC

Transistor output

VEGATOR 256C

no transistor output

VEGATOR 532

Number, function	1 output, synchronously switching with the relay
Galvanic separation	Floating
Maximum values	
– U_B	36 V DC
– I_B	≤ 60 mA
Transistor voltage loss (U_{CE})	approx. 1.5 V at I_B 60 mA
Inverse current (I_0)	≤ 10 μ A

VEGATOR 631

Number, function	1 output, synchronously switching with the relay
Galvanic separation	Floating
Maximum values	
– U_B	36 V DC
– I_B	≤ 60 mA
Transistor voltage loss (U_{CE})	approx. 1.5 V at I_B 60 mA
Inverse current (I_0)	≤ 10 μ A

Adjustment elements

VEGATOR 256C

Control lamp to the indication of the relay switching status
 Potentiometer to the adaptation of the product conductivity

VEGATOR 532

DIL switch for preadjustment of the mode
 Potentiometer for switching point adjustment

Control lamps in the front plate
 – Status indication operating voltage
 – Status indication fault signal
 – Status indication switching point control

Signal lamp green (LED)
 Signal lamp red (LED)
 Signal lamp yellow (LED)

VEGATOR 631

DIL switch block for preadjustment of the integration time and mode
 Potentiometer for switching point adjustment

Control lamps in the front plate
 – Status indication operating voltage
 – Status indication fault signal
 – Status indication switching point control

Signal lamp green (LED)
 Signal lamp red (LED)
 Signal lamp yellow (LED)

Ambient conditions

VEGATOR 256C

Ambient temperature -20 ... +50 °C (-4 ... +122 °F)
 Storage and transport temperature -40 ... +70 °C (-40 ... +158 °F)

VEGATOR 532

Ambient temperature -20 ... +60 °C (-4 ... +140 °F)
 Storage and transport temperature -40 ... +70 °C (-40 ... +158 °F)

VEGATOR 631

Ambient temperature -20 ... +60 °C (-4 ... +140 °F)
 Storage and transport temperature -40 ... +70 °C (-40 ... +158 °F)

Electromechanical data

VEGATOR 256C

Spring-loaded terminals for wire cross-section up to 1.5 mm² (AWG 16)

VEGATOR 532

Electrical connection
 – Carrier BGT596 Ex 33-pole multipoint connector, series F (d, b, z) with coding holes
 – Housing type 505 Ex Screw terminal for wire cross-section up to 1.5 mm² (AWG 16)

VEGATOR 631

Screw terminals for wire cross-section up to 1.5 mm² (AWG 16)

Electrical protective measures

VEGATOR 256C

Protection IP 20
 Protection class II

VEGATOR 532

Protection
 – Signal conditioning instrument - not mounted IP 00
 – mounted into BGT596 Ex - front side (completely equipped) IP 30
 – mounted into BGT596 Ex - upper and lower side IP 20
 – mounted into BGT596 Ex - wiring side IP 00
 – mounted into housing type 505 Ex IP 30
 Overvoltage category II

Protection class	II
VEGATOR 631	
Protection	
– Signal conditioning instrument	IP 30
– Plug-in socket	IP 20
Overvoltage category	II
Protection class	II
Electrical separating measures	reliable separation (VDE 0106, part 1) between power supply, sensor input, level relay and transistor output

Approvals¹⁾

VEGATOR 532	
ATEX	ATEX II (1) GD [EEx ia] IIC
Others	WHG
VEGATOR 631	
ATEX	ATEX II (1) G [EEx ia] IIC
Others	WHG Ship approval

¹⁾ Deviating data in Ex applications: see separate safety instructions.

7 Dimensions

VEGATOR 256C

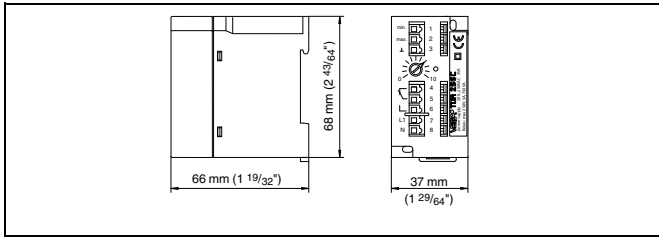

Fig. 25: VEGATOR 256C

VEGATOR 532

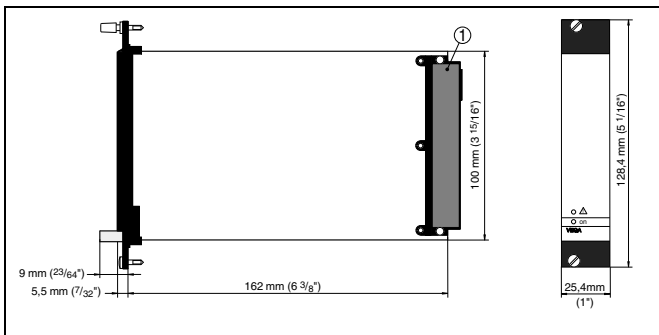

Fig. 26: VEGATOR 532

- 1 Male multipoint connector

VEGATOR 631

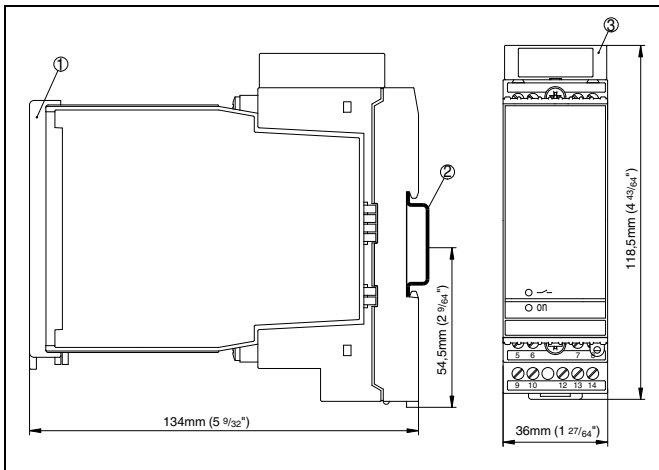
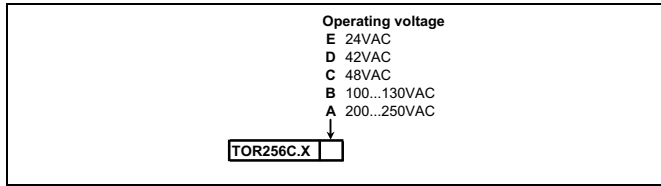

Fig. 27: VEGATOR 631

- 1 Transparent cover
 2 Carrier rail 35 x 7.5 or 35 x 15 according to EN 50022
 3 Ex separating chamber

8 Product code

VEGATOR 256C



VEGATOR 532

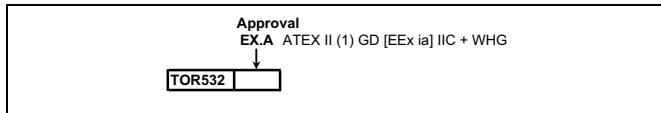

VEGATOR 631

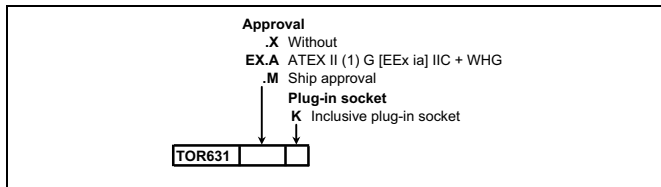



VEGA

VEGA Grieshaber KG
Am Hohenstein 113
77761 Schiltach
Germany
Phone +49 7836 50-0
Fax +49 7836 50-201
E-Mail: info@de.vega.com
www.vega.com



You can find at www.vega.com downloads of the following

- operating instructions manuals
- menu schematics
- software
- certificates
- approvals

and much, much more